

## G2-LAURA-M-P

~30° medium beam. Assembly with thinner white holder, installation tape and location pins.

### TECHNICAL SPECIFICATIONS:

Dimensions	21.6 x 21.6 mm
Height	13.1 mm
Fastening	tape, pin
ROHS compliant	yes ⓘ

### MATERIAL SPECIFICATIONS:

Component	Type	Material	Colour	Finish
LAURA-M	Single lens	PMMA	clear	
LAURA-LT-PIN-XP-HLD-WHT	Holder	PC	white	
ROSE-TAPE	Tape	Acrylic foam	black	

### ORDERING INFORMATION:

Component	Type	Qty in box	MOQ	MPQ	Box weight (kg)
CA13627_G2-LAURA-M-P	Single lens		360	180	6.2
» Box size:					



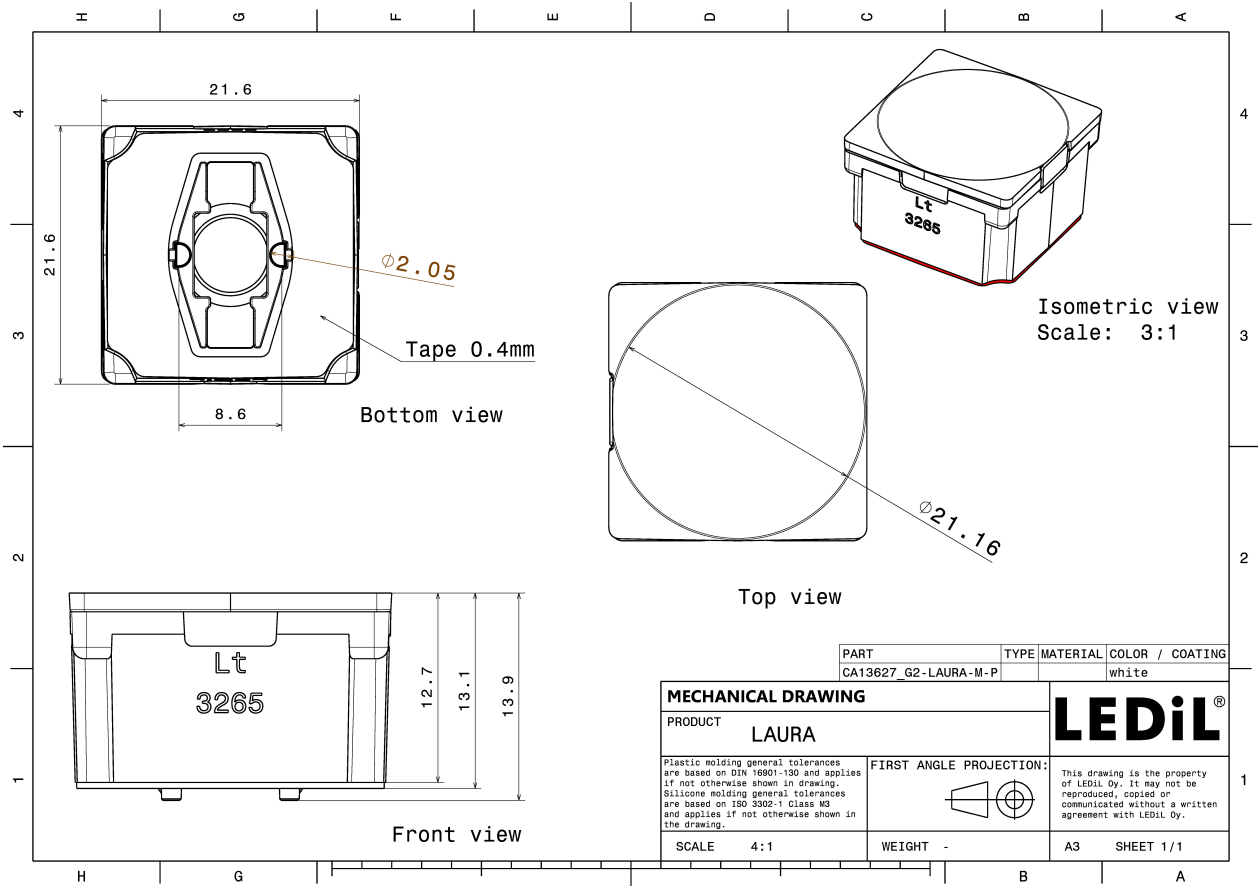

See also our general installation guide: [www.ledil.com/installation\\_guide](http://www.ledil.com/installation_guide)

#### PHOTOMETRIC DATA (MEASURED):

##### CREE LED

LED XB-H  
 FWHM / FWTM 33.0° / 59.0°  
 Efficiency 85 %  
 Peak intensity 2.3 cd/lm  
 LEDs/each optic 1  
 Light colour White  
 Required components:

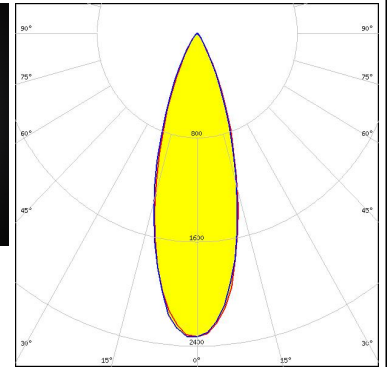
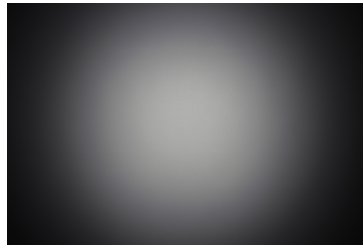

##### CREE LED

LED XP-E  
 FWHM / FWTM 30.0° / 53.0°  
 Efficiency 92 %  
 Peak intensity 2.6 cd/lm  
 LEDs/each optic 1  
 Light colour White  
 Required components:



##### CREE LED

LED XP-E2  
 FWHM / FWTM 31.0° / 56.0°  
 Efficiency 85 %  
 Peak intensity 2.5 cd/lm  
 LEDs/each optic 1  
 Light colour White  
 Required components:

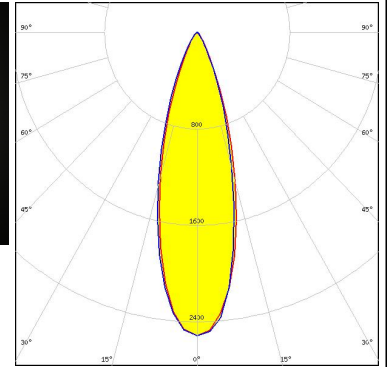
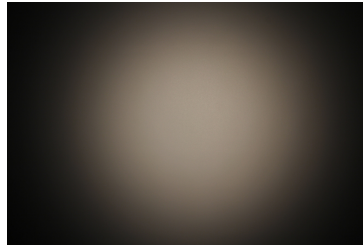





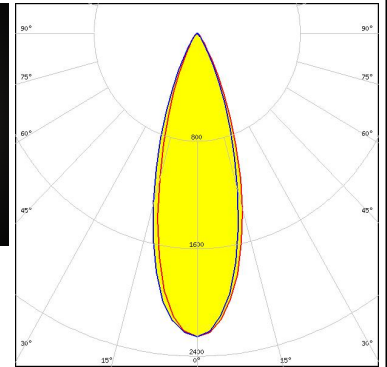
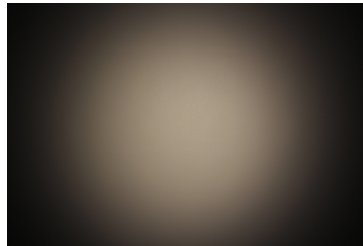

##### CREE LED

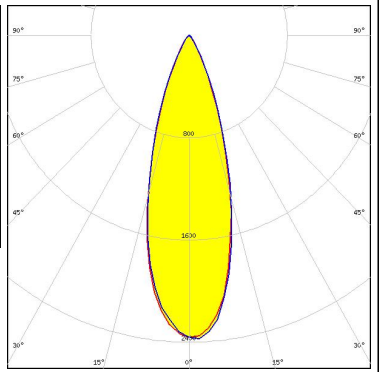

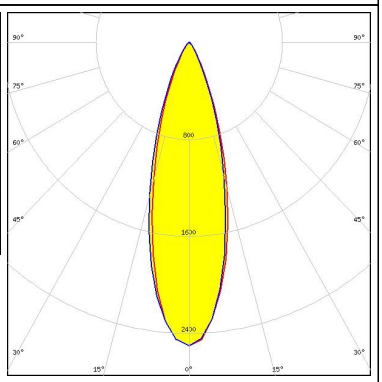

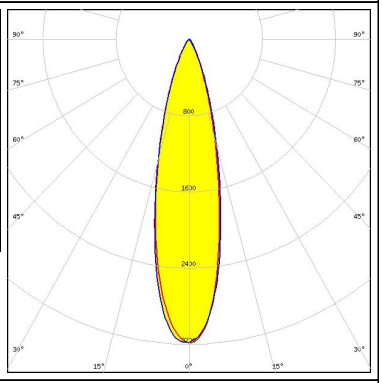

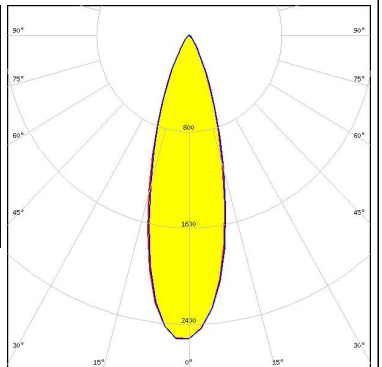
LED XP-G  
 FWHM / FWTM 33.0° / 59.0°  
 Efficiency 83 %  
 Peak intensity 2.3 cd/lm  
 LEDs/each optic 1  
 Light colour White  
 Required components:



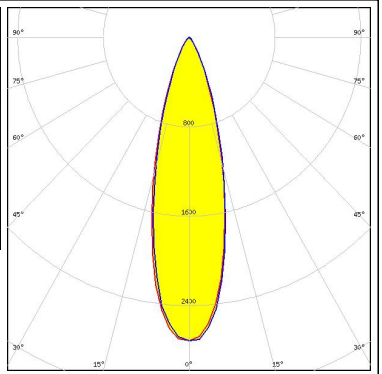

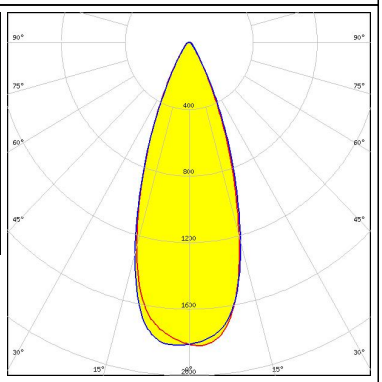

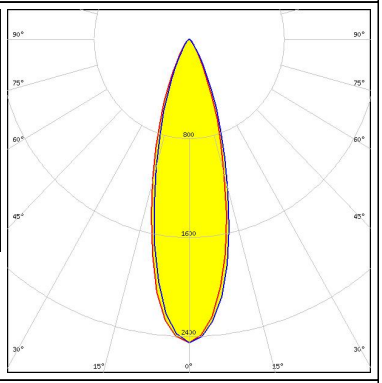
#### PHOTOMETRIC DATA (MEASURED):

<p><b>CREE</b> LED</p> <p>LED: XP-G2            FWHM / FWTM: 33.0° / 58.0°            Efficiency: 85 %            Peak intensity: 2.4 cd/m            LEDs/each optic: 1            Light colour: White            Required components:</p>		
<p><b>CREE</b> LED</p> <p>LED: XT-E            FWHM / FWTM: 31.0° / 58.0°            Efficiency: 85 %            Peak intensity: 2.5 cd/m            LEDs/each optic: 1            Light colour: White            Required components:</p>		
<p><b>LUMILEDS</b></p> <p>LED: LUXEON 3030 2D (Round LES)            FWHM / FWTM: 25.0° / 51.0°            Efficiency: 85 %            Peak intensity: 3.2 cd/m            LEDs/each optic: 1            Light colour: White            Required components:</p>		
<p><b>LUMILEDS</b></p> <p>LED: LUXEON TX            FWHM / FWTM: 30.0° / 57.0°            Efficiency: 86 %            Peak intensity: 2.5 cd/m            LEDs/each optic: 1            Light colour: White            Required components:</p>		

#### PHOTOMETRIC DATA (MEASURED):

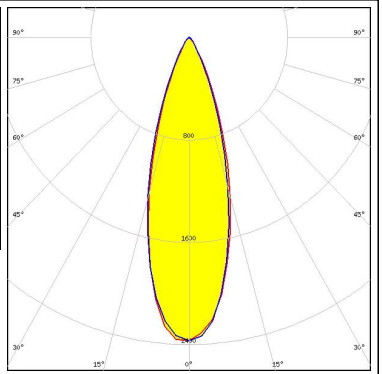
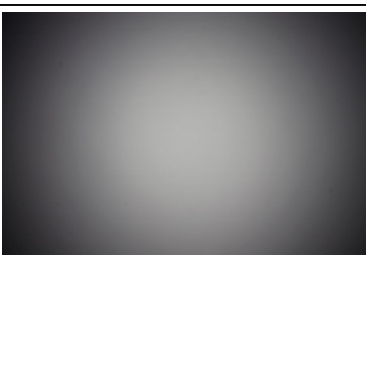
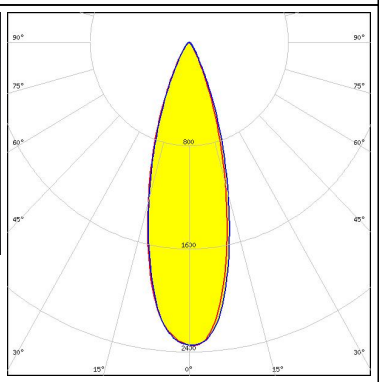
<p><b>NICHIA</b></p> <p>LED NCSxx19A            FWHM / FWTM 29.0° / 55.0°            Efficiency 86 %            Peak intensity 2.7 cd/lm            LEDs/each optic 1            Light colour White            Required components:</p>		
<p><b>NICHIA</b></p> <p>LED NVSW219D            FWHM / FWTM 38.0° / 63.0°            Efficiency 92 %            Peak intensity 1.8 cd/lm            LEDs/each optic 1            Light colour White            Required components:</p>		
<p><b>NICHIA</b></p> <p>LED NVSxx19A            FWHM / FWTM 30.0° / 58.0°            Efficiency 85 %            Peak intensity 2.5 cd/lm            LEDs/each optic 1            Light colour White            Required components:</p>		
<p><b>NICHIA</b></p> <p>LED NVSxx19B/NVSxx19C            FWHM / FWTM 28.0° / 56.0°            Efficiency 84 %            Peak intensity 2.8 cd/lm            LEDs/each optic 1            Light colour White            Required components:</p>		

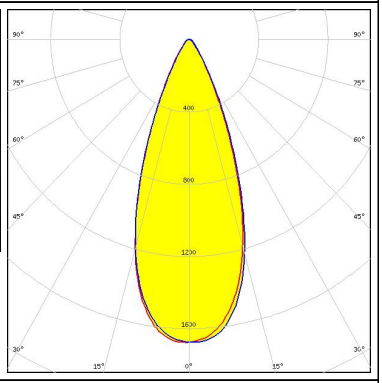
#### PHOTOMETRIC DATA (MEASURED):

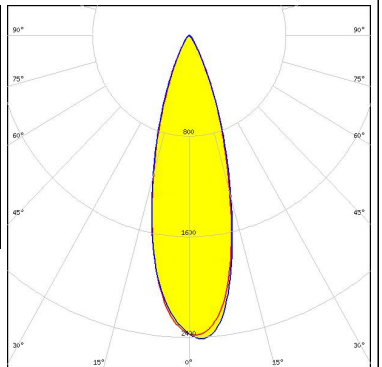
<p><b>OSRAM</b> Opto Semiconductors</p> <p>LED OSLON Square EC</p> <p>FWHM / FWTM 32.0° / 58.0°</p> <p>Efficiency 85 %</p> <p>Peak intensity 2.4 cd/m</p> <p>LEDs/each optic 1</p> <p>Light colour White</p> <p>Required components:</p>		
<p><b>OSRAM</b> Opto Semiconductors</p> <p>LED OSLON Square PC</p> <p>FWHM / FWTM 31.0° / 57.0°</p> <p>Efficiency 84 %</p> <p>Peak intensity 2.4 cd/m</p> <p>LEDs/each optic 1</p> <p>Light colour White</p> <p>Required components:</p>		
<p><b>SAMSUNG</b></p> <p>LED LH351D</p> <p>FWHM / FWTM 40.0° / 67.0°</p> <p>Efficiency 92 %</p> <p>Peak intensity 1.7 cd/m</p> <p>LEDs/each optic 1</p> <p>Light colour White</p> <p>Required components:</p>		
<p><b>SEOUL SEMICONDUCTOR</b></p> <p>LED Z5M1/Z5M2</p> <p>FWHM / FWTM 30.0° / 56.0°</p> <p>Efficiency 84 %</p> <p>Peak intensity 2.4 cd/m</p> <p>LEDs/each optic 1</p> <p>Light colour White</p> <p>Required components:</p>		

#### PHOTOMETRIC DATA (MEASURED):



#### PHOTOMETRIC DATA (SIMULATED):

<p><b>CREE → LED</b></p> <p>LED: XHP35 HI            FWHM / FWTM: 28.0° / 61.0°            Efficiency: 93 %            Peak intensity: 2.2 cd/lm            LEDs/each optic: 1            Light colour: White            Required components:</p>	
<p><b>CREE → LED</b></p> <p>LED: XP-L2            FWHM / FWTM: 38.0° / 63.0°            Efficiency: 93 %            Peak intensity: 2 cd/lm            LEDs/each optic: 1            Light colour: White            Required components:</p>	
<p><b>CREE → LED</b></p> <p>LED: XQ-E HD            FWHM / FWTM: 32.3° / 55.7°            Efficiency: 94 %            Peak intensity: 2.8 cd/lm            LEDs/each optic: 1            Light colour: White            Required components:</p>	
<p><b>CREE → LED</b></p> <p>LED: XQ-E HI            FWHM / FWTM: 27.0° / 49.0°            Efficiency: 94 %            Peak intensity: 3.7 cd/lm            LEDs/each optic: 1            Light colour: White            Required components:</p>	



#### PHOTOMETRIC DATA (SIMULATED):

##### OSRAM

Opto Semiconductors

LED KW CULPM1.TG  
 FWHM / FWTM 30.0° / 51.0°  
 Efficiency 96 %  
 Peak intensity 3.4 cd/lm  
 LEDs/each optic 1  
 Light colour White  
 Required components:

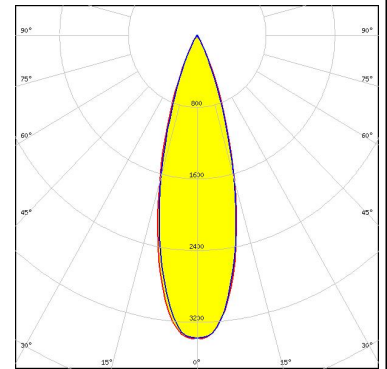

##### OSRAM

Opto Semiconductors

LED OSLOM Black  
 FWHM / FWTM 22.0° / 40.0°  
 Efficiency 94 %  
 Peak intensity 5.3 cd/lm  
 LEDs/each optic 1  
 Light colour White  
 Required components:

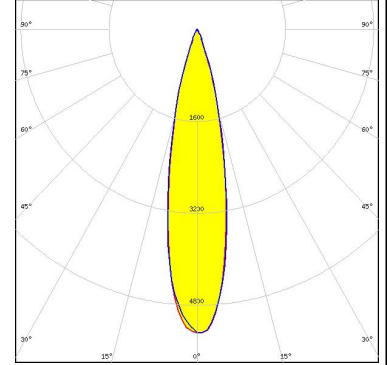

##### OSRAM

Opto Semiconductors

LED OSLOM Black Flat  
 FWHM / FWTM 21.0° / 42.0°  
 Efficiency 94 %  
 Peak intensity 5.4 cd/lm  
 LEDs/each optic 1  
 Light colour White  
 Required components:

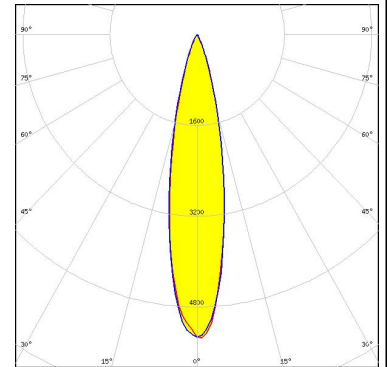

##### OSRAM

Opto Semiconductors

LED OSLOM Signal  
 FWHM / FWTM 30.0° / 51.0°  
 Efficiency 96 %  
 Peak intensity 3.4 cd/lm  
 LEDs/each optic 1  
 Light colour Red  
 Required components:

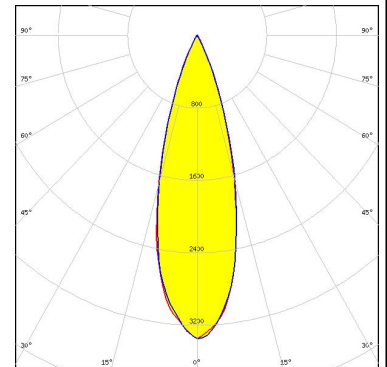

#### PHOTOMETRIC DATA (SIMULATED):

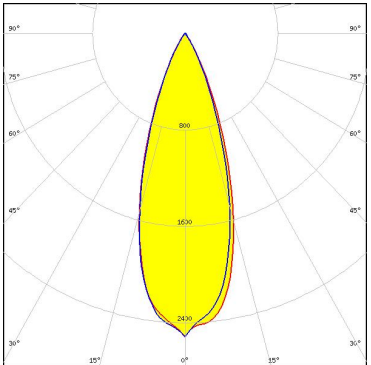
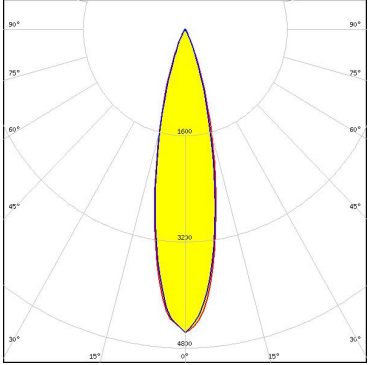
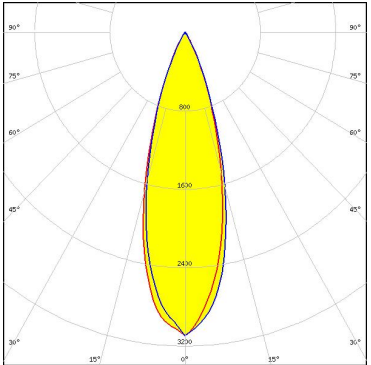
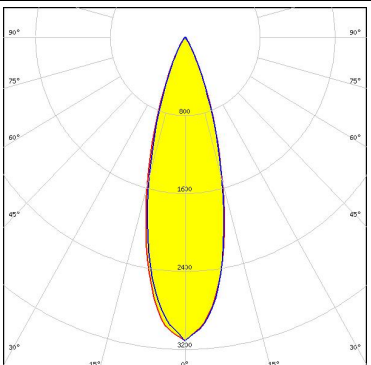
<p><b>OSRAM</b> Opto Semiconductors</p> <p>LED OSOLON Square CSSRM2/CSSRM3</p> <p>FWHM / FWTM 34.0° / 58.0°</p> <p>Efficiency 95 %</p> <p>Peak intensity 2.5 cd/lm</p> <p>LEDs/each optic 1</p> <p>Light colour White</p> <p>Required components:</p>	
<p><b>OSRAM</b> Opto Semiconductors</p> <p>LED OSOLON Square Flat</p> <p>FWHM / FWTM 24.0° / 45.0°</p> <p>Efficiency 94 %</p> <p>Peak intensity 4.6 cd/lm</p> <p>LEDs/each optic 1</p> <p>Light colour White</p> <p>Required components:</p>	
<p><b>OSRAM</b> Opto Semiconductors</p> <p>LED OSOLON SSL 150</p> <p>FWHM / FWTM 30.0° / 53.0°</p> <p>Efficiency 94 %</p> <p>Peak intensity 3.1 cd/lm</p> <p>LEDs/each optic 1</p> <p>Light colour White</p> <p>Required components:</p>	
<p><b>OSRAM</b> Opto Semiconductors</p> <p>LED OSOLON SSL 80</p> <p>FWHM / FWTM 29.0° / 53.0°</p> <p>Efficiency 95 %</p> <p>Peak intensity 3.1 cd/lm</p> <p>LEDs/each optic 1</p> <p>Light colour White</p> <p>Required components:</p>	

#### PHOTOMETRIC DATA (SIMULATED):

##### **OSRAM** Opto Semiconductors

LED SFH 4770S  
FWHM / FWTM 27.0° / 56.0°  
Efficiency 88 %  
LEDs/each optic 1  
Light colour White  
Required components:



##### SEOUL SEMICONDUCTOR

LED Z8Y22P  
FWHM / FWTM 29.0° / 51.0°  
Efficiency 94 %  
Peak intensity 3.4 cd/lm  
LEDs/each optic 1  
Light colour White  
Required components:

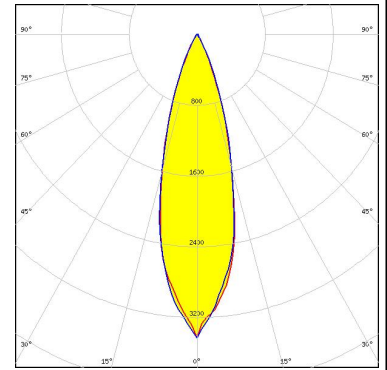

### GENERAL INFORMATION:

NOTE: The typical beam angle will be changed by different color, chip size and chip position tolerance. The typical total beam angle is the full angle measured where the luminous intensity is half of the peak value.

### MATERIALS:

As part of our continuous research and improvement processes, and to ensure the best possible quality and availability of our products, LEDiL reserves the right to change material grades without notice.

### PRODUCT DATA USER AGREEMENT AND DISCLAIMER:

The measured data in the provided downloadable LEDiL Product Datasheets and Mechanical 2D-Drawings is rounded and provided as reference for planning. LEDiL Oy's optical specifications have been verified by conducting performance testing of the products in accordance with the company's quality system. The reported data are averaged results of multiple measurements with typical variation. LEDiL Oy reserves the right to without prior notification make changes and improvements to its products.

LEDiL Oy assumes neither warranty, nor guarantee nor any other liability of any kind for the contents and correctness of the provided data. The provided data has been generated with highest diligence but the provided data may in reality not represent the complete possible variation range of all intrinsic parameters. Therefore, in certain cases a deviation from the provided data could occur.

LEDiL Oy reserves the right to undertake technical changes of its products without further notification which could lead to changes in the provided data. LEDiL Oy assumes no liability of any kind for the possible deviation from any provided data or any other damage resulting from the usage of the provided data.

The user agrees to this disclaimer and user agreement with the download or usage of the provided files.

#### LEDiL Oy

Joensuunkatu 13  
FI-24240 SALO  
Finland

#### LEDiL Inc.

228 West Page Street  
Suite D  
Sycamore IL 60178  
USA

#### Ledil Optics Technology (Shenzhen) Co., Ltd.

# 405 , Block B  
Casic Motor Building  
Shenzhen 518057  
P.R.CHINA

#### Local sales and technical support

[www.ledil.com/  
where\\_to\\_buy](http://www.ledil.com/where_to_buy)

#### Shipping locations

Salo, Finland  
Hong Kong, China

#### Distribution Partners

[www.ledil.com/  
where\\_to\\_buy](http://www.ledil.com/where_to_buy)