

LENINA-XW

White version with ~75° wide beam

TECHNICAL SPECIFICATIONS:

Dimensions	Ø 74.0 mm
Height	40 mm
Fastening	socket
ROHS compliant	yes ⓘ

MATERIAL SPECIFICATIONS:

Component	Type	Material
LENINA-XW	Reflector	HRPC

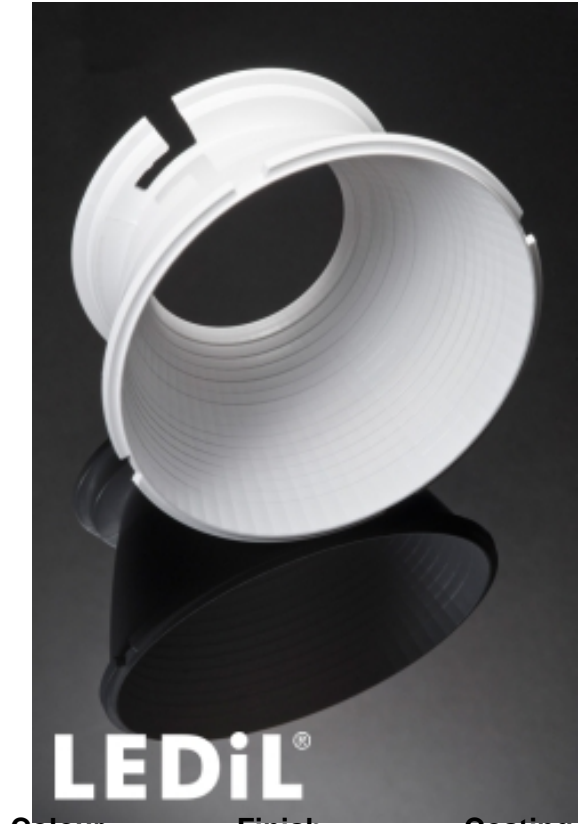

Colour	Finish	Coating
white		

ORDERING INFORMATION:

Component

C12958_LENINA-XW



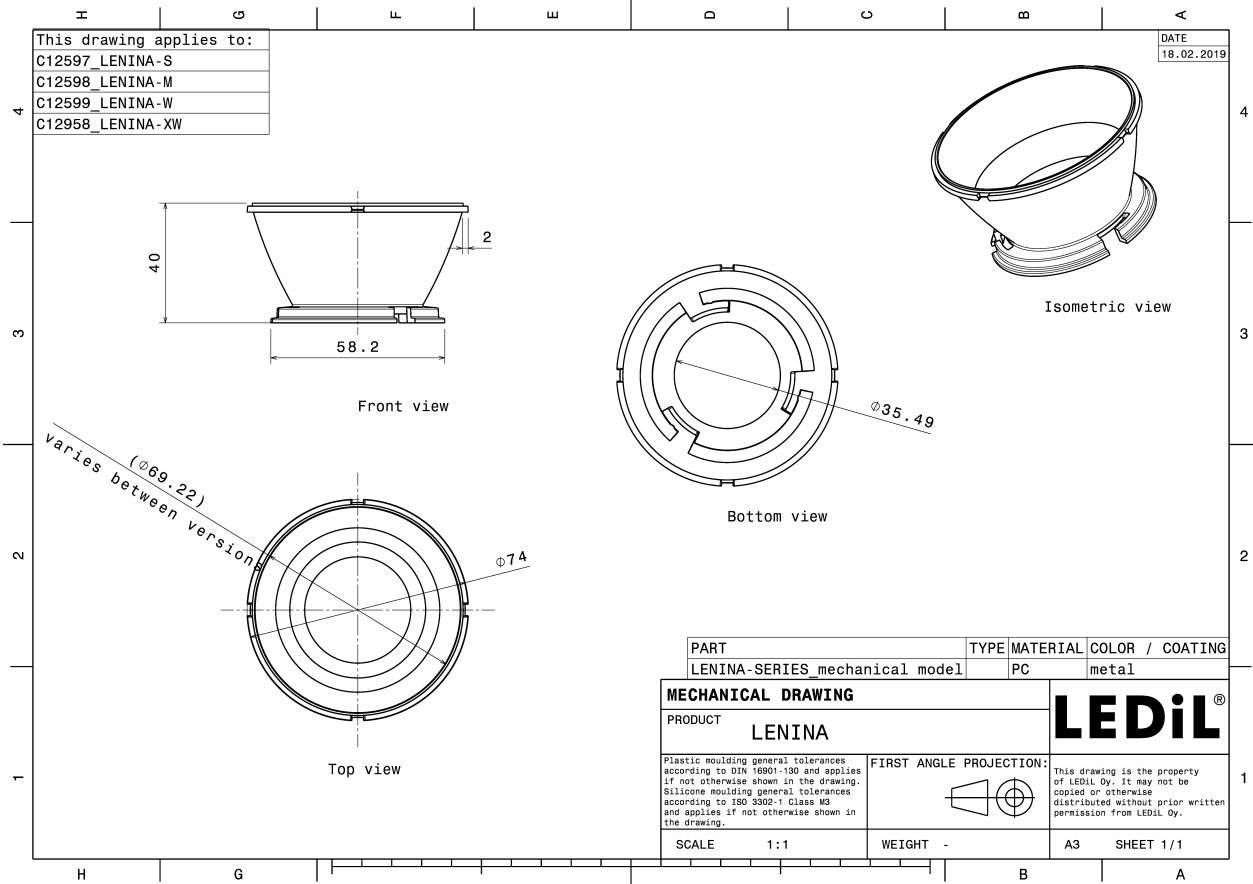

» Box size: 476 x 273 x 197 mm

Qty in box	MOQ	MPQ	Box weight (kg)
60	120	60	2.0





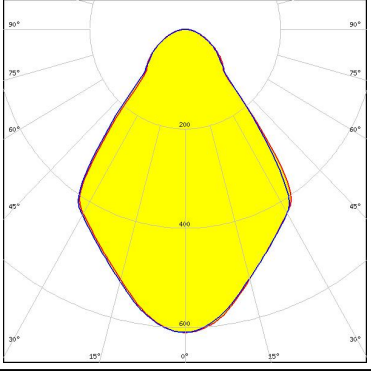

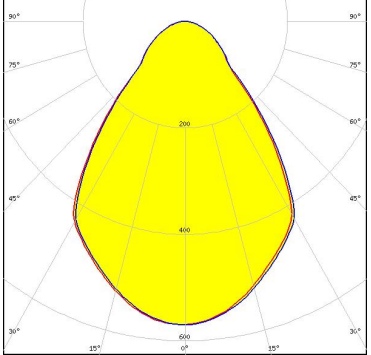

See also our general installation guide: www.ledil.com/installation_guide



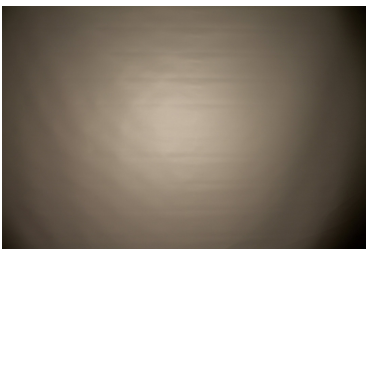
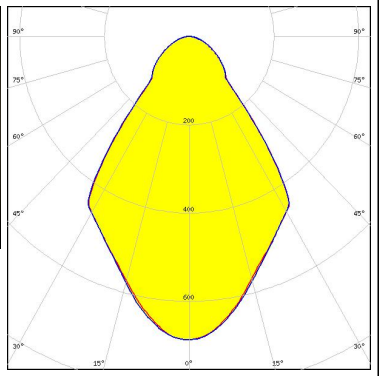

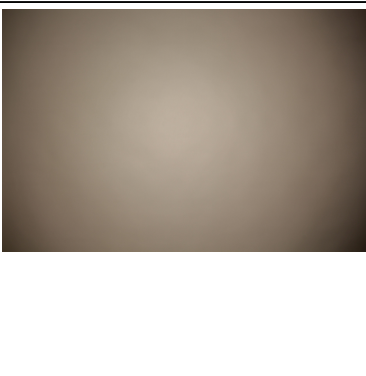
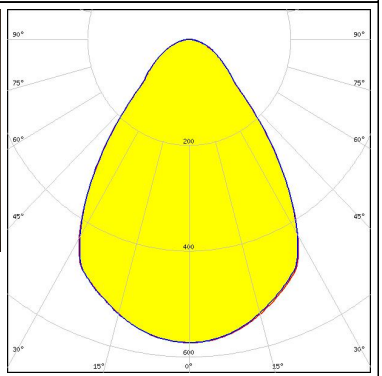

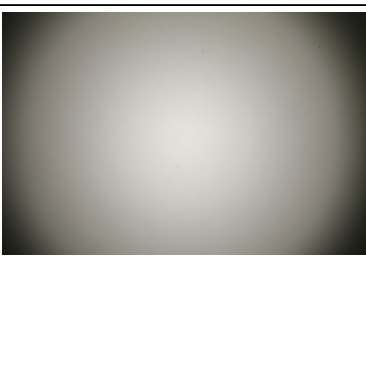
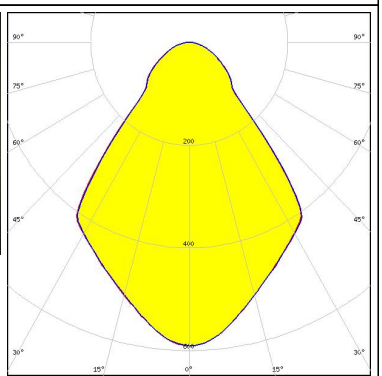
PHOTOMETRIC DATA (MEASURED):

<p></p> <p>LED BXRA ES Rectangle FWHM / FWTM 73.0° / 125.0° Efficiency 84 % Peak intensity 0.6 cd/lm LEDs/each optic 1 Light colour White Required components: C12153_LENINA-STD-BASE-BXRA C12606_LENINA-DL</p>	
<p></p> <p>LED BXRA ES Rectangle FWHM / FWTM 74.0° / 124.0° Efficiency 89 % Peak intensity 0.6 cd/lm LEDs/each optic 1 Light colour White Required components: C12153_LENINA-STD-BASE-BXRA</p>	
<p></p> <p>LED BXRA RS FWHM / FWTM 87.0° / 128.0° Efficiency 87 % Peak intensity 0.5 cd/lm LEDs/each optic 1 Light colour White Required components: C12229_LENINA-STD-BASE-RS C12606_LENINA-DL</p>	
<p></p> <p>LED BXRA RS FWHM / FWTM 76.0° / 128.0° Efficiency 91 % Peak intensity 0.6 cd/lm LEDs/each optic 1 Light colour White Required components: C12229_LENINA-STD-BASE-RS</p>	

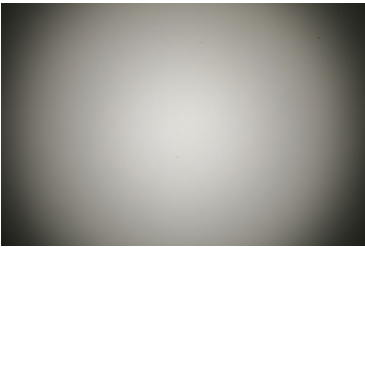
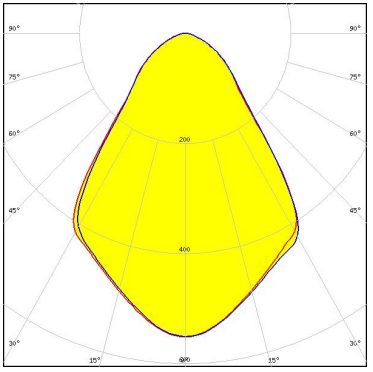

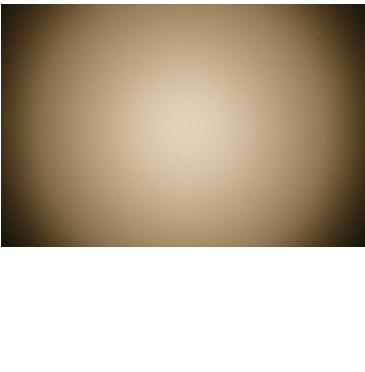
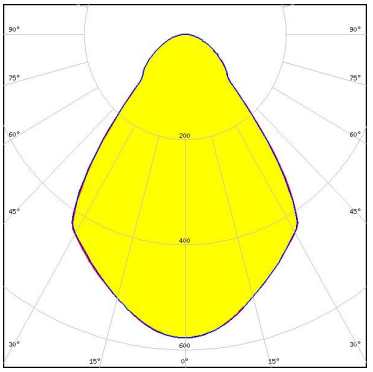
PHOTOMETRIC DATA (MEASURED):

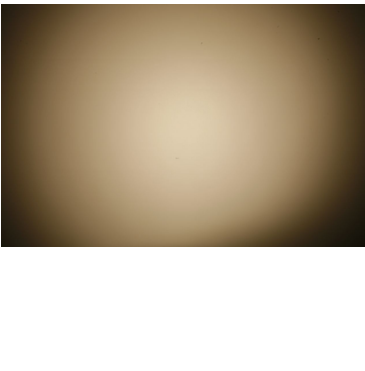
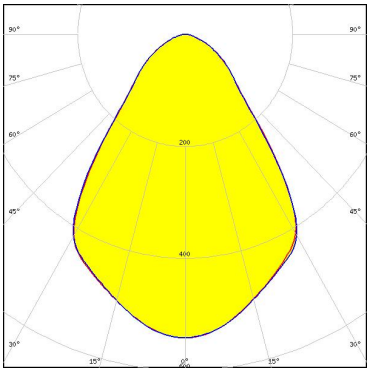
<p></p> <p>LED V10 Gen6</p> <p>FWHM / FWTM 69.0° / 124.0°</p> <p>Efficiency 86 %</p> <p>Peak intensity 0.7 cd/lm</p> <p>LEDs/each optic 1</p> <p>Light colour White</p> <p>Required components: C13186_LENINA-STD-BASE-CXA15 C12606_LENINA-DL</p>		
<p></p> <p>LED V4 HD</p> <p>FWHM / FWTM 71.0° / 120.0°</p> <p>Efficiency 93 %</p> <p>Peak intensity 0.7 cd/lm</p> <p>LEDs/each optic 1</p> <p>Light colour White</p> <p>Required components: C14146_LENINA-STD-BASE-CXA18</p>		
<p></p> <p>LED Vero SE 29</p> <p>FWHM / FWTM 76.0° / 127.0°</p> <p>Efficiency 93 %</p> <p>Peak intensity 0.6 cd/lm</p> <p>LEDs/each optic 1</p> <p>Light colour White</p> <p>Required components: C15083_LENINA-STD-BASE-VERO29</p>		
<p></p> <p>LED VERO13</p> <p>FWHM / FWTM 76.0° / 128.0°</p> <p>Efficiency 91 %</p> <p>Peak intensity 0.6 cd/lm</p> <p>LEDs/each optic 1</p> <p>Light colour White</p> <p>Required components: C13868_LENINA-STD-BASE-VERO13-18</p>		

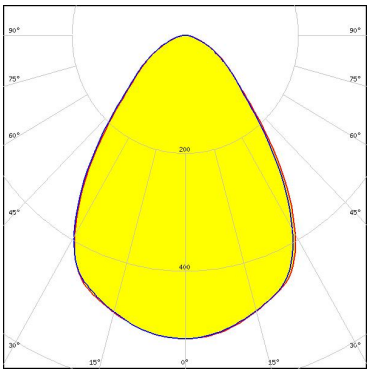
PHOTOMETRIC DATA (MEASURED):

<p></p> <p>LED VERO13 FWHM / FWTM 75.0° / 127.0° Efficiency 87 % Peak intensity 0.6 cd/lm LEDs/each optic 1 Light colour White</p> <p>Required components: C13868_LENINA-STD-BASE-VERO13-18 C12606_LENINA-DL</p>		
<p></p> <p>LED VERO18 FWHM / FWTM 76.0° / 128.0° Efficiency 91 % Peak intensity 0.6 cd/lm LEDs/each optic 1 Light colour White</p> <p>Required components: C13868_LENINA-STD-BASE-VERO13-18</p>		
<p></p> <p>LED VERO18 FWHM / FWTM 75.0° / 128.0° Efficiency 87 % Peak intensity 0.5 cd/lm LEDs/each optic 1 Light colour White</p> <p>Required components: C13868_LENINA-STD-BASE-VERO13-18 C12606_LENINA-DL</p>		
<p></p> <p>LED VERO29 FWHM / FWTM 77.0° / 129.0° Efficiency 87 % Peak intensity 0.5 cd/lm LEDs/each optic 1 Light colour White</p> <p>Required components: C13867_LENINA-STD-BASE-VERO29 C12606_LENINA-DL</p>		

PHOTOMETRIC DATA (MEASURED):

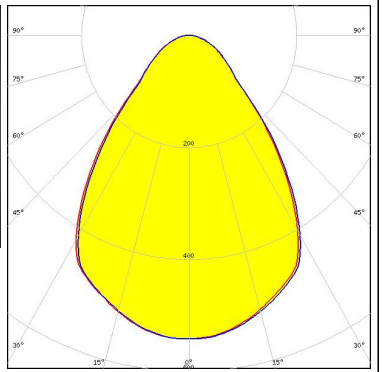
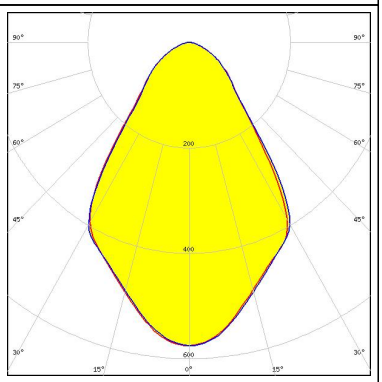
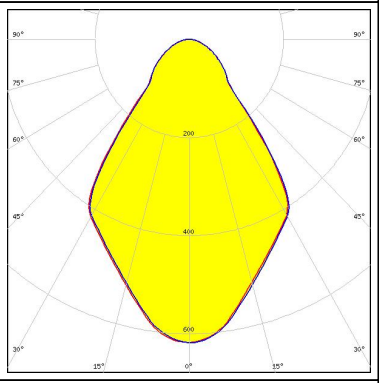
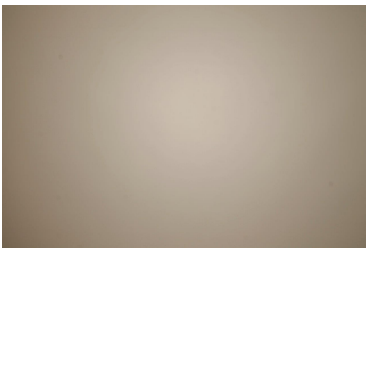
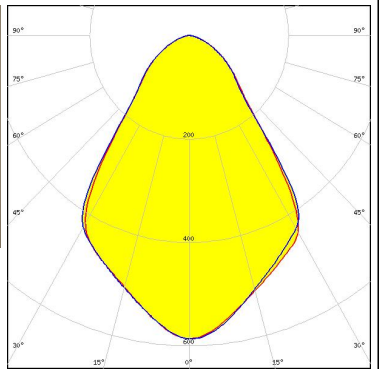
<p></p> <p>LED VERO29 FWHM / FWTM 77.0° / 130.0° Efficiency 91 % Peak intensity 0.5 cd/lm LEDs/each optic 1 Light colour White Required components: C13867_LENINA-STD-BASE-VERO29</p>		
<p>CITIZEN</p> <p>LED CL-L340 FWHM / FWTM 71.0° / 123.5° Efficiency 82 % Peak intensity 0.6 cd/lm LEDs/each optic 1 Light colour White Required components: C11995_LENINA-STD-BASE-CL340 C12606_LENINA-DL</p>		
<p>CITIZEN</p> <p>LED CL-L340 FWHM / FWTM 72.0° / 122.0° Efficiency 86 % Peak intensity 0.6 cd/lm LEDs/each optic 1 Light colour White Required components: C11995_LENINA-STD-BASE-CL340</p>		
<p>CITIZEN</p> <p>LED CLL02x/CLU02x (LES10) FWHM / FWTM 73.0° / 125.0° Efficiency 89 % Peak intensity 0.6 cd/lm LEDs/each optic 1 Light colour White Required components: C13868_LENINA-STD-BASE-VERO13-18 C12606_LENINA-DL Bender Wirth: 434 Typ L1</p>		

PHOTOMETRIC DATA (MEASURED):

CITIZEN

LED CLL02x/CLU02x (LES10)
 FWHM / FWTM 75.0° / 125.0°
 Efficiency 93 %
 Peak intensity 0.6 cd/lm
 LEDs/each optic 1
 Light colour White
 Required components:
 C13868_LENINA-STD-BASE-VERO13-18
 Bender Wirth: 434 Typ L1

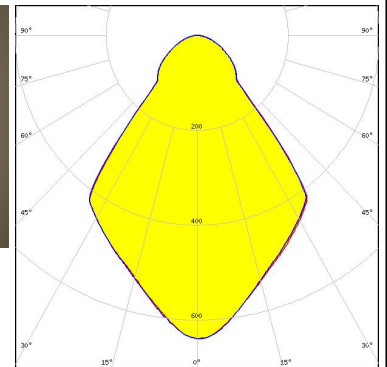
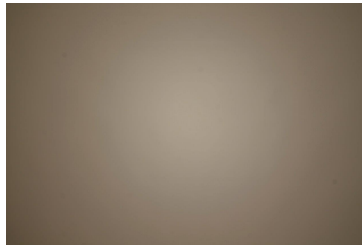

CITIZEN

LED CLL03x/CLU03x
 FWHM / FWTM 75.0° / 126.0°
 Efficiency 94 %
 Peak intensity 0.6 cd/lm
 LEDs/each optic 1
 Light colour White
 Required components:
 C13868_LENINA-STD-BASE-VERO13-18
 Bender Wirth: 433 Typ L1

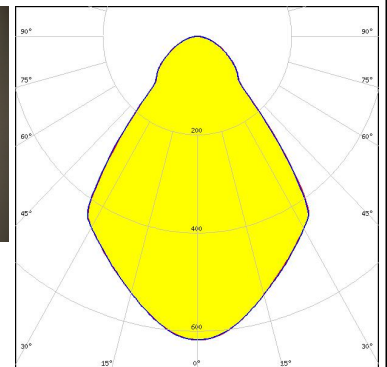
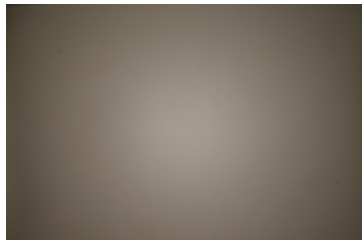

CITIZEN

LED CLL03x/CLU03x
 FWHM / FWTM 74.0° / 124.0°
 Efficiency 93 %
 Peak intensity 0.6 cd/lm
 LEDs/each optic 1
 Light colour White
 Required components:
 C12691_LENINA-STD-BASE-CLL030

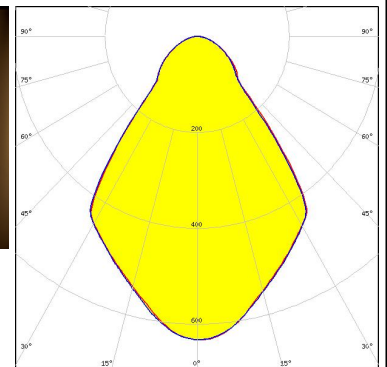

CITIZEN

LED CLL03x/CLU03x
 FWHM / FWTM 74.0° / 125.0°
 Efficiency 89 %
 Peak intensity 0.6 cd/lm
 LEDs/each optic 1
 Light colour White
 Required components:
 C13868_LENINA-STD-BASE-VERO13-18
 C12606_LENINA-DL
 Bender Wirth: 433 Typ L1

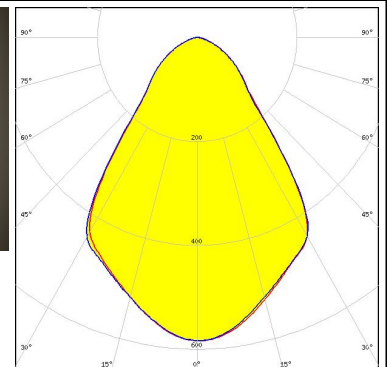
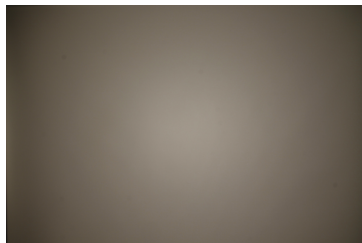

PHOTOMETRIC DATA (MEASURED):

CITIZEN

LED CLL03x/CLU03x
 FWHM / FWTM 72.0° / 125.0°
 Efficiency 88 %
 Peak intensity 0.6 cd/lm
 LEDs/each optic 1
 Light colour White
 Required components:
 C12691_LENINA-STD-BASE-CLL030
 C12606_LENINA-DL

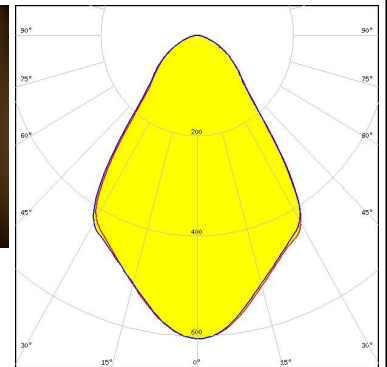
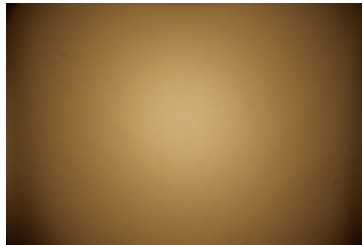

CITIZEN

LED CLL04x/CLU04x
 FWHM / FWTM 71.0° / 124.0°
 Efficiency 84 %
 Peak intensity 0.6 cd/lm
 LEDs/each optic 1
 Light colour White
 Required components:
 C12692_LENINA-STD-BASE-CLL040
 C12606_LENINA-DL

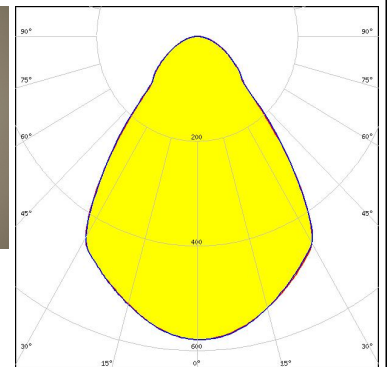
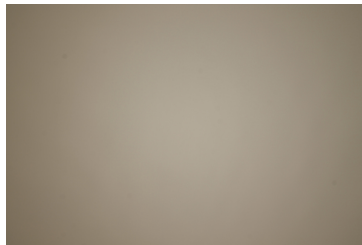

CITIZEN

LED CLL04x/CLU04x
 FWHM / FWTM 75.0° / 127.0°
 Efficiency 93 %
 Peak intensity 0.6 cd/lm
 LEDs/each optic 1
 Light colour White
 Required components:
 C13867_LENINA-STD-BASE-VERO29
 Bender Wirth: 431 Typ L3

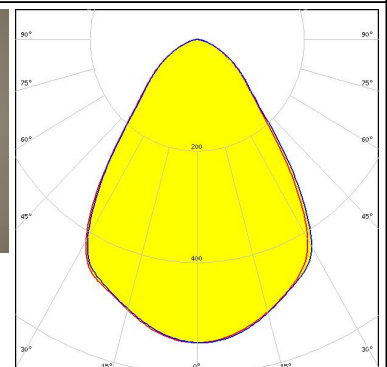
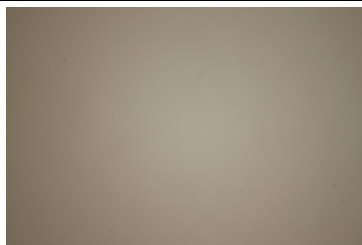

CITIZEN

LED CLL04x/CLU04x
 FWHM / FWTM 75.0° / 127.0°
 Efficiency 89 %
 Peak intensity 0.5 cd/lm
 LEDs/each optic 1
 Light colour White
 Required components:
 C13867_LENINA-STD-BASE-VERO29
 C12606_LENINA-DL
 Bender Wirth: 431 Typ L3

PHOTOMETRIC DATA (MEASURED):

CITIZEN

LED CLL04x/CLU04x
 FWHM / FWTM 74.0° / 126.0°
 Efficiency 84 %
 Peak intensity 0.5 cd/lm
 LEDs/each optic 1
 Light colour White
 Required components:
 A.A.G. STUCCHI: 8102-G2 + S-8000-12

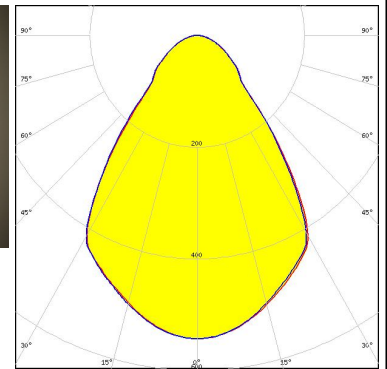
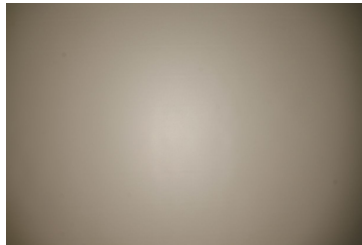

CITIZEN

LED CLL04x/CLU04x
 FWHM / FWTM 71.0° / 122.0°
 Efficiency 89 %
 Peak intensity 0.6 cd/lm
 LEDs/each optic 1
 Light colour White
 Required components:
 C12692_LENINA-STD-BASE-CLL040

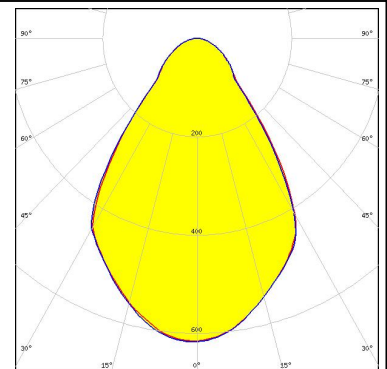

CITIZEN

LED CLL04x/CLU04x
 FWHM / FWTM 73.0° / 126.0°
 Efficiency 81 %
 Peak intensity 0.5 cd/lm
 LEDs/each optic 1
 Light colour White
 Required components:
 C12606_LENINA-DL
 A.A.G. STUCCHI: 8102-G2 + S-8000-12

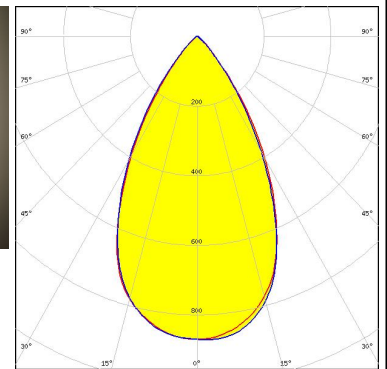
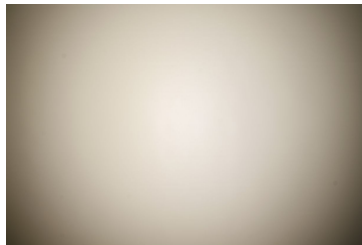

CITIZEN

LED CLL04x/CLU04x
 FWHM / FWTM 72.0° / 124.0°
 Efficiency 91 %
 Peak intensity 0.6 cd/lm
 LEDs/each optic 1
 Light colour White
 Required components:
 IDEAL: 50-2204CT + 50-2100LN

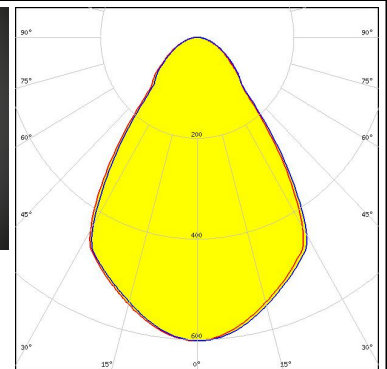
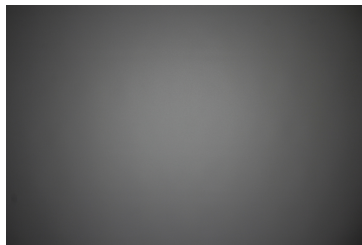

PHOTOMETRIC DATA (MEASURED):

CITIZEN

LED CLL04x/CLU04x
 FWHM / FWTM 71.0° / 124.0°
 Efficiency 88 %
 Peak intensity 0.6 cd/lm
 LEDs/each optic 1
 Light colour White
 Required components:
 C12606_LENINA-DL
 IDEAL: 50-2204CT + 50-2100LN

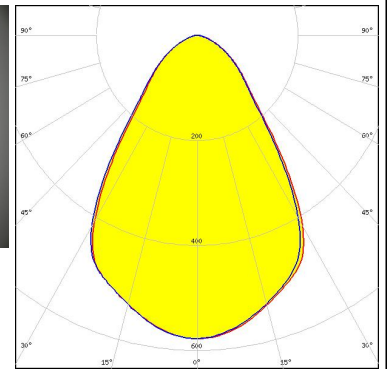
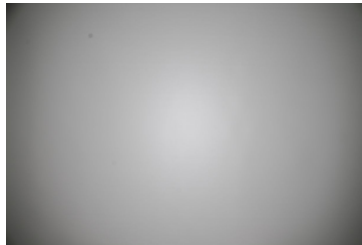

CITIZEN

LED CLU700/701/702
 FWHM / FWTM 75.0° / 122.0°
 Efficiency 93 %
 Peak intensity 0.7 cd/lm
 LEDs/each optic 1
 Light colour White
 Required components:
 C13868_LENINA-STD-BASE-VERO13-18
 Bender Wirth: 434 Typ L1

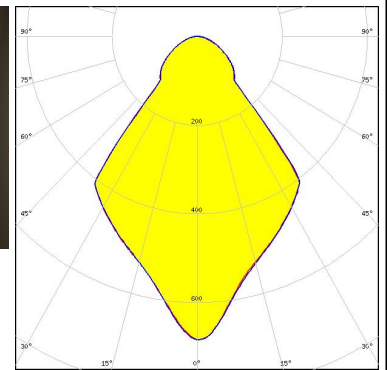
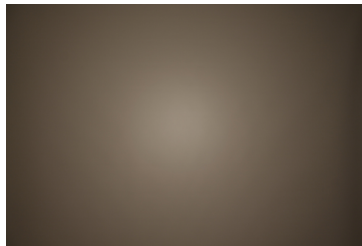

CITIZEN

LED CLU700/701/702
 FWHM / FWTM 73.0° / 124.0°
 Efficiency 89 %
 Peak intensity 0.6 cd/lm
 LEDs/each optic 1
 Light colour White
 Required components:
 C13868_LENINA-STD-BASE-VERO13-18
 C12606_LENINA-DL
 Bender Wirth: 434 Typ L1

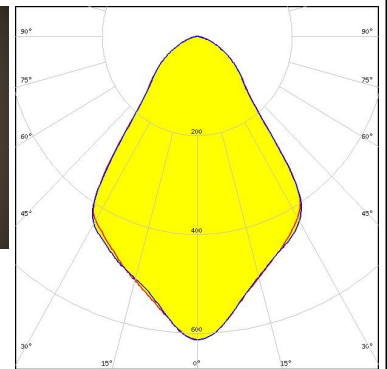
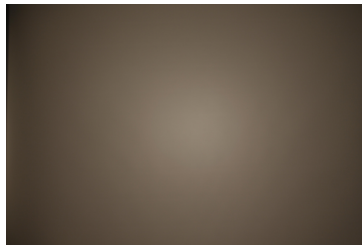

CITIZEN

LED CLU710/711
 FWHM / FWTM 73.0° / 127.0°
 Efficiency 90 %
 Peak intensity 0.6 cd/lm
 LEDs/each optic 1
 Light colour White
 Required components:
 C12691_LENINA-STD-BASE-CLL030
 C12606_LENINA-DL

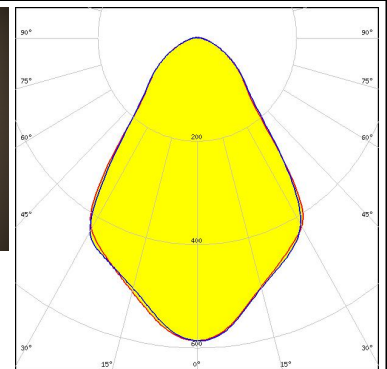
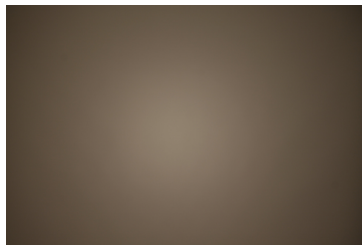

PHOTOMETRIC DATA (MEASURED):

CITIZEN

LED CLU710/711
 FWHM / FWTM 75.0° / 127.0°
 Efficiency 94 %
 Peak intensity 0.6 cd/lm
 LEDs/each optic 1
 Light colour White
 Required components:
 C12691_LENINA-STD-BASE-CLL030

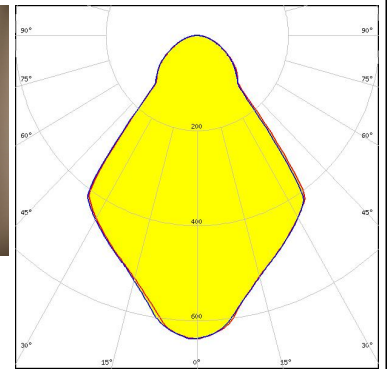
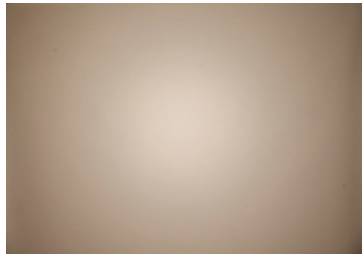

CITIZEN

LED CLU720/721
 FWHM / FWTM 73.0° / 127.0°
 Efficiency 85 %
 Peak intensity 0.6 cd/lm
 LEDs/each optic 1
 Light colour White
 Required components:
 C12691_LENINA-STD-BASE-CLL030
 C12606_LENINA-DL

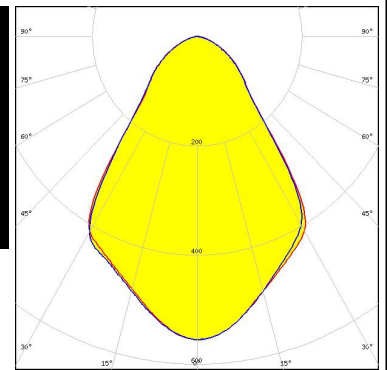
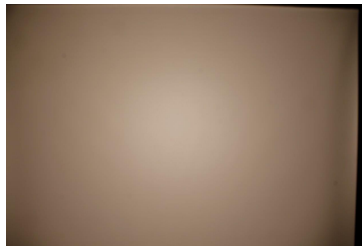

CITIZEN

LED CLU720/721
 FWHM / FWTM 74.0° / 127.0°
 Efficiency 89 %
 Peak intensity 0.6 cd/lm
 LEDs/each optic 1
 Light colour White
 Required components:
 C12691_LENINA-STD-BASE-CLL030

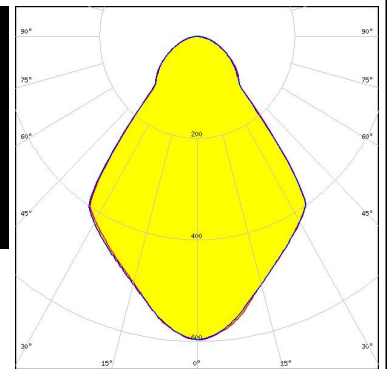
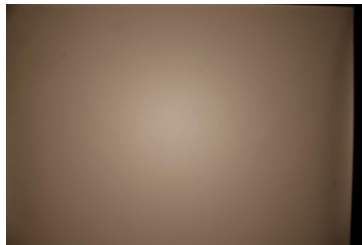

CITIZEN

LED CLU730/731
 FWHM / FWTM 72.0° / 124.0°
 Efficiency 94 %
 Peak intensity 0.7 cd/lm
 LEDs/each optic 1
 Light colour White
 Required components:
 C12692_LENINA-STD-BASE-CLL040

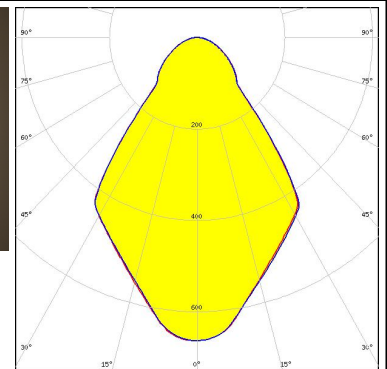

PHOTOMETRIC DATA (MEASURED):

CITIZEN

LED CLU730/731
 FWHM / FWTM 71.0° / 125.0°
 Efficiency 84 %
 Peak intensity 0.6 cd/lm
 LEDs/each optic 1
 Light colour White
 Required components:
 C12692_LENASTD-BASE-CLL040
 C12606_LENINA-DL

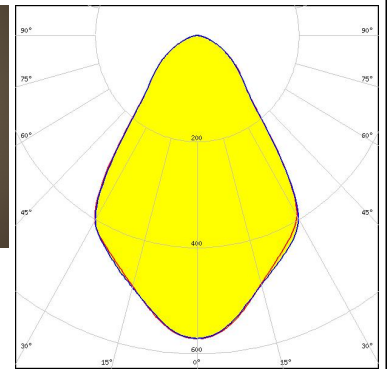
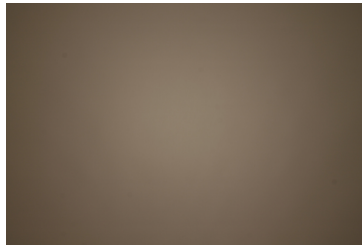

CREE LED

LED CMA1840
 FWHM / FWTM 71.0° / 120.0°
 Efficiency 93 %
 Peak intensity 0.7 cd/lm
 LEDs/each optic 1
 Light colour White
 Required components:
 C14146_LENASTD-BASE-CXA18

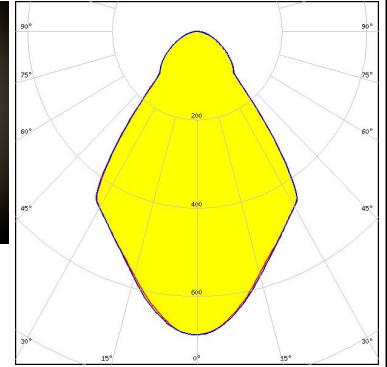

CREE LED

LED CMA2550
 FWHM / FWTM 71.0° / 121.0°
 Efficiency 94 %
 Peak intensity 0.7 cd/lm
 LEDs/each optic 1
 Light colour White
 Required components:
 C13324_LENASTD-BASE-CXA25

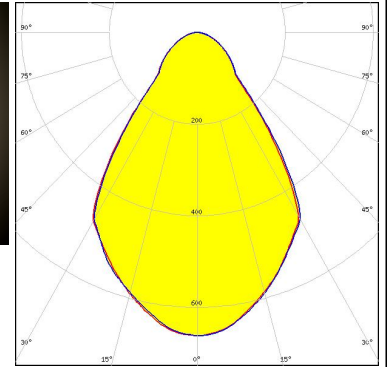



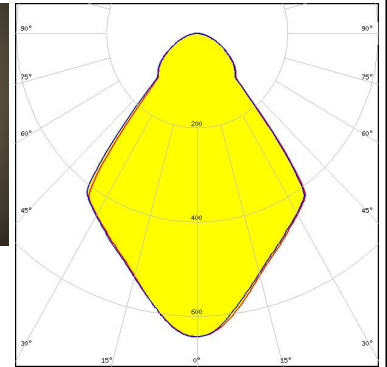
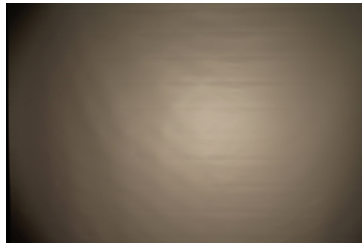

CREE LED

LED CMT14xx
 FWHM / FWTM 75.0° / 124.0°
 Efficiency 94 %
 Peak intensity 0.7 cd/lm
 LEDs/each optic 1
 Light colour White
 Required components:
 C13868_LENASTD-BASE-VERO13-18
 Bender Wirth: 434 Typ L1

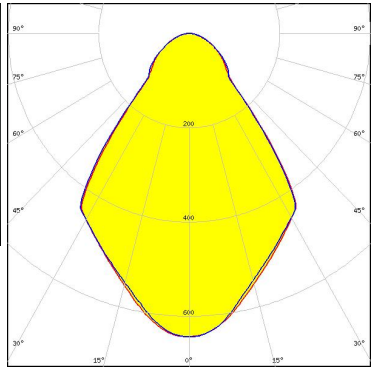

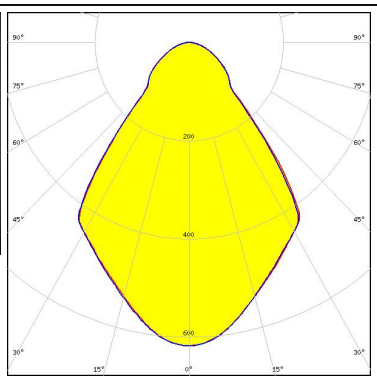
PHOTOMETRIC DATA (MEASURED):

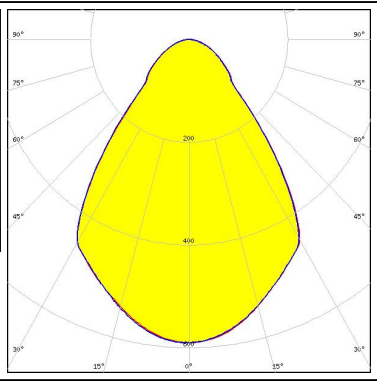
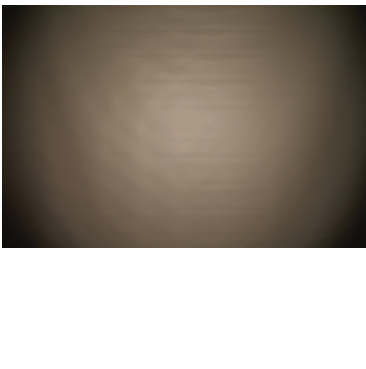
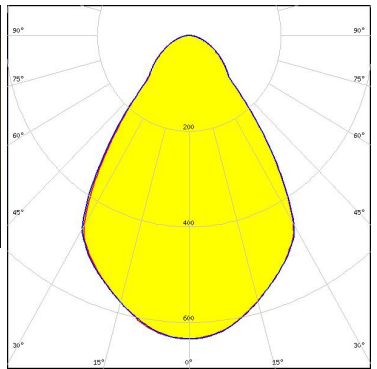
<p>CREE → LED</p> <p>LED CMT19xx FWHM / FWTM 74.0° / 124.0° Efficiency 94 % Peak intensity 0.6 cd/m LEDs/each optic 1 Light colour White Required components: C12691_LENINA-STD-BASE-CLL030</p>		
<p>CREE → LED</p> <p>LED CMT19xx FWHM / FWTM 75.0° / 126.0° Efficiency 94 % Peak intensity 0.6 cd/m LEDs/each optic 1 Light colour White Required components: C13868_LENINA-STD-BASE-VERO13-18 Bender Wirth: 477 Typ L1</p>		
<p>CREE → LED</p> <p>LED CMT28xx FWHM / FWTM 75.0° / 126.0° Efficiency 93 % Peak intensity 0.6 cd/m LEDs/each optic 1 Light colour White Required components: C13867_LENINA-STD-BASE-VERO29 Bender Wirth: 471 Typ L3</p>		
<p>CREE → LED</p> <p>LED CMT28xx FWHM / FWTM 72.0° / 123.0° Efficiency 94 % Peak intensity 0.6 cd/m LEDs/each optic 1 Light colour White Required components: C12692_LENINA-STD-BASE-CLL040</p>		

PHOTOMETRIC DATA (MEASURED):



LED CXA/B 15xx
 FWHM / FWTM 75.0° / 124.0°
 Efficiency 93 %
 Peak intensity 0.6 cd/m
 LEDs/each optic 1
 Light colour White
 Required components:
 C13868_LENINA-STD-BASE-VERO13-18
 Bender Wirth: 441 Typ L1

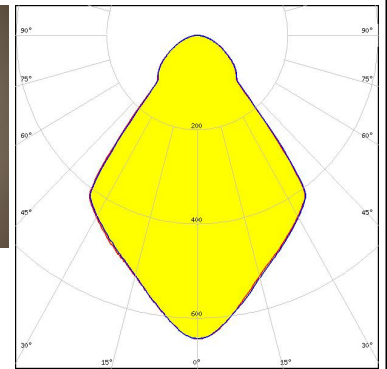
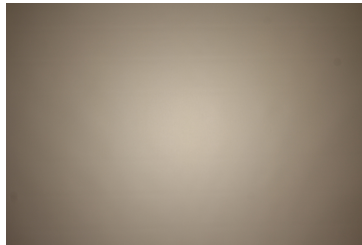

LED CXA/B 15xx
 FWHM / FWTM 73.0° / 125.0°
 Efficiency 89 %
 Peak intensity 0.6 cd/m
 LEDs/each optic 1
 Light colour White
 Required components:
 C13868_LENINA-STD-BASE-VERO13-18
 C12606_LENINA-DL
 Bender Wirth: 441 Typ L1

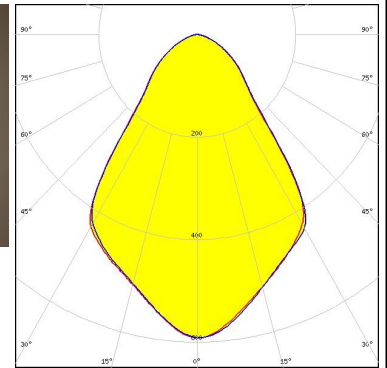
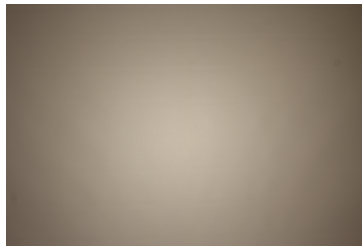

LED CXA/B 15xx
 FWHM / FWTM 69.0° / 120.0°
 Efficiency 86 %
 Peak intensity 0.7 cd/m
 LEDs/each optic 1
 Light colour White
 Required components:
 C13186_LENINA-STD-BASE-CXA15
 C12606_LENINA-DL

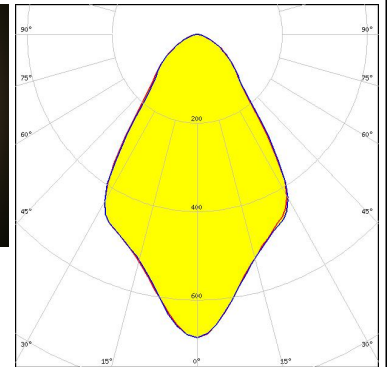
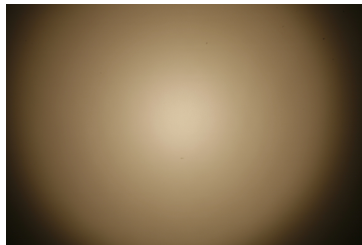

LED CXA/B 15xx
 FWHM / FWTM 70.0° / 113.0°
 Efficiency 91 %
 Peak intensity 0.8 cd/m
 LEDs/each optic 1
 Light colour White
 Required components:
 C13186_LENINA-STD-BASE-CXA15

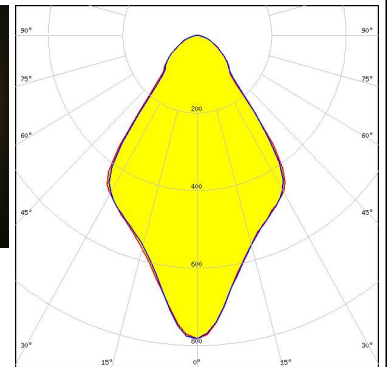
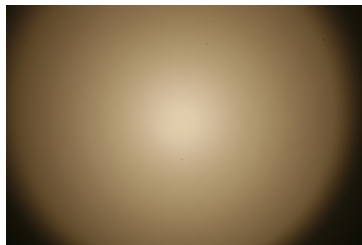

PHOTOMETRIC DATA (MEASURED):



LED CXA/B 1816 & CXA/B 1820 & CXA 1850
 FWHM / FWTM 73.0° / 124.0°
 Efficiency 94 %
 Peak intensity 0.8 cd/lm
 LEDs/each optic 1
 Light colour White
 Required components:
 C14146_LENINA-STD-BASE-CXA18

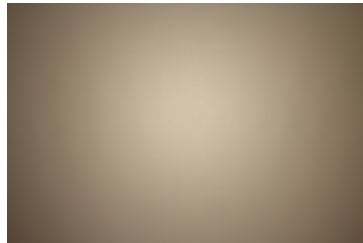

LED CXA/B 1816 & CXA/B 1820 & CXA 1850
 FWHM / FWTM 75.0° / 125.0°
 Efficiency 93 %
 Peak intensity 0.6 cd/lm
 LEDs/each optic 1
 Light colour White
 Required components:
 C13868_LENINA-STD-BASE-VERO13-18
 Bender Wirth: 437 Typ L1

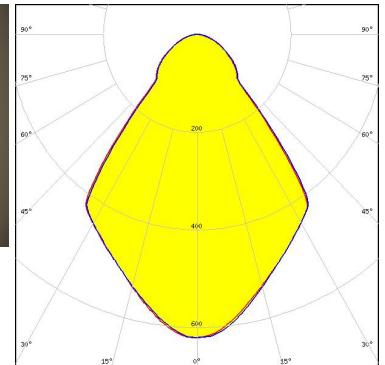
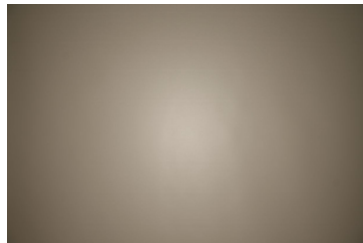



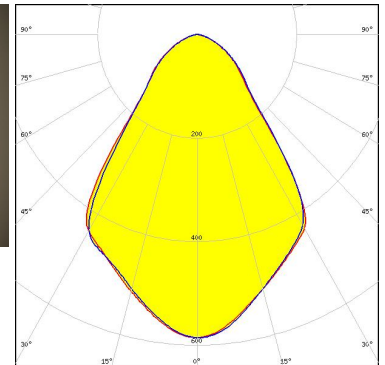
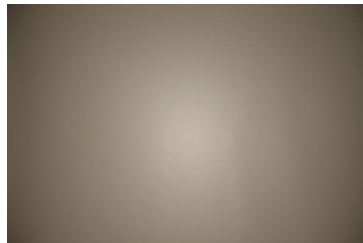

LED CXA/B 1816 & CXA/B 1820 & CXA 1850
 FWHM / FWTM 74.0° / 125.0°
 Efficiency 89 %
 Peak intensity 0.6 cd/lm
 LEDs/each optic 1
 Light colour White
 Required components:
 C13868_LENINA-STD-BASE-VERO13-18
 C12606_LENINA-DL
 Bender Wirth: 437 Typ L1



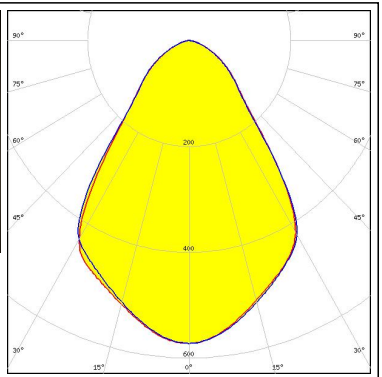

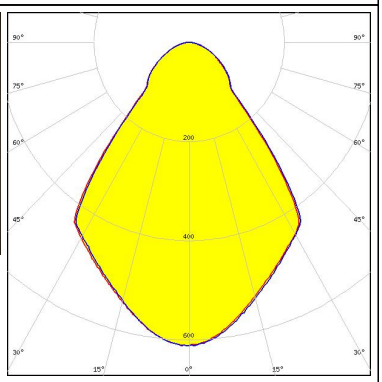
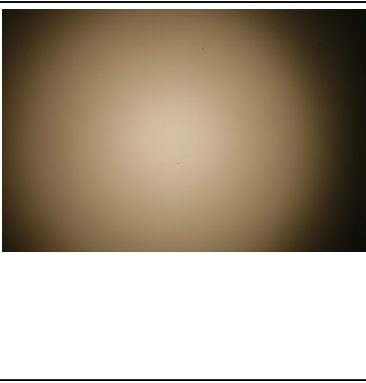
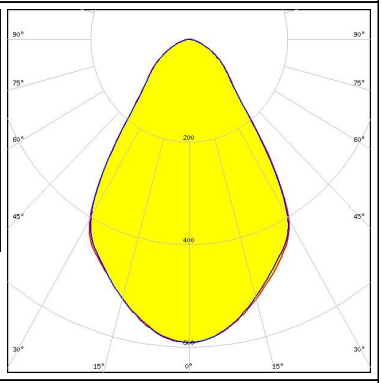

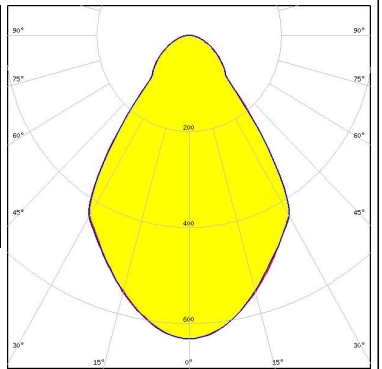
LED CXA/B 1816 & CXA/B 1820 & CXA 1850
 FWHM / FWTM 73.0° / 124.0°
 Efficiency 94 %
 Peak intensity 0.8 cd/lm
 LEDs/each optic 1
 Light colour White
 Required components:
 C14146_LENINA-STD-BASE-CXA18
 C12606_LENINA-DL

PHOTOMETRIC DATA (MEASURED):

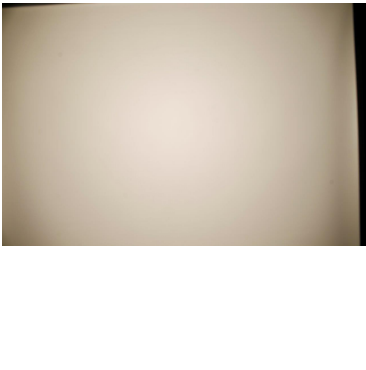
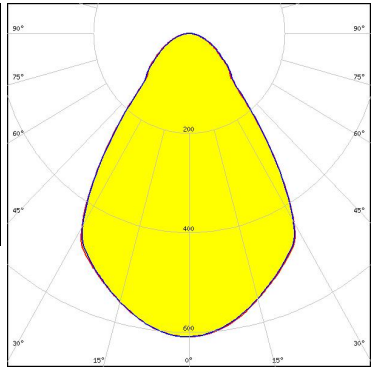
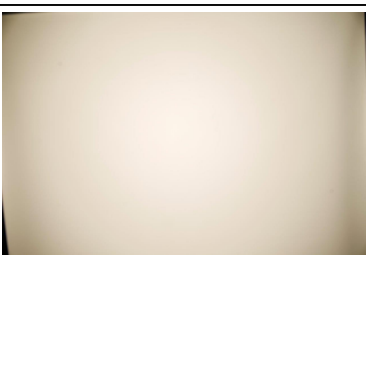
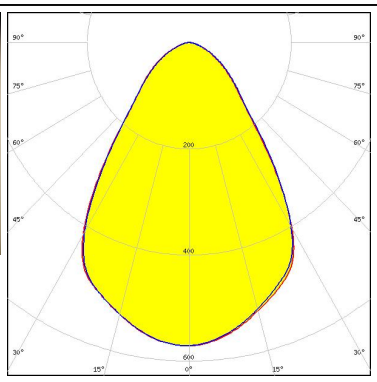
<p>CREE LED</p> <p>LED CXA/B 1830 FWHM / FWTM 74.0° / 126.0° Efficiency 89 % Peak intensity 0.6 cd/lm LEDs/each optic 1 Light colour White</p> <p>Required components: C13868_LENINA-STD-BASE-VERO13-18 C12606_LENINA-DL Bender Wirth: 437 Typ L1</p>		
<p>CREE LED</p> <p>LED CXA/B 1830 FWHM / FWTM 75.0° / 126.0° Efficiency 94 % Peak intensity 0.6 cd/lm LEDs/each optic 1 Light colour White</p> <p>Required components: C13868_LENINA-STD-BASE-VERO13-18 Bender Wirth: 437 Typ L1</p>		
<p>CREE LED</p> <p>LED CXA/B 25xx FWHM / FWTM 70.0° / 120.0° Efficiency 84 % Peak intensity 0.6 cd/lm LEDs/each optic 1 Light colour White</p> <p>Required components: C13324_LENINA-STD-BASE-CXA25 C12606_LENINA-DL</p>		
<p>CREE LED</p> <p>LED CXA/B 25xx FWHM / FWTM 70.0° / 120.0° Efficiency 89 % Peak intensity 0.7 cd/lm LEDs/each optic 1 Light colour White</p> <p>Required components: C13324_LENINA-STD-BASE-CXA25</p>		

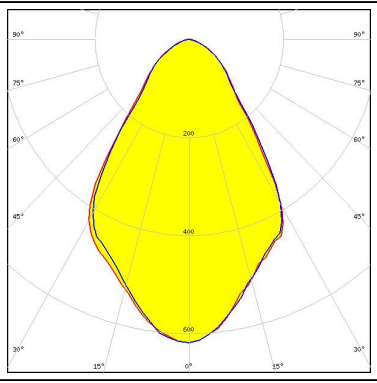
PHOTOMETRIC DATA (MEASURED):

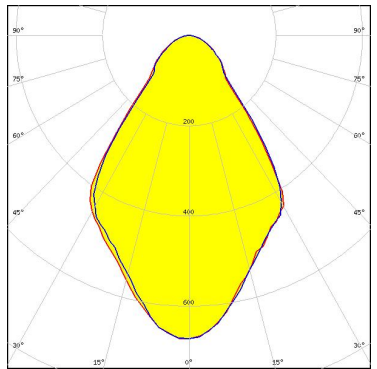
<p>CREE ⇄ LED</p> <p>LED CXA/B 30xx FWHM / FWTM 72.0° / 123.0° Efficiency 91 % Peak intensity 0.6 cd/lm LEDs/each optic 1 Light colour White Required components: IDEAL: 50-2234C + 50-2100LN</p>		
<p>CREE ⇄ LED</p> <p>LED CXA/B 30xx FWHM / FWTM 77.0° / 124.0° Efficiency 87 % Peak intensity 0.6 cd/lm LEDs/each optic 1 Light colour White Required components: C12606_LENINA-DL IDEAL: 50-2234C + 50-2100LN</p>		
<p>CREE ⇄ LED</p> <p>LED CXA2011 FWHM / FWTM 70.0° / 123.0° Efficiency 82 % Peak intensity 0.6 cd/lm LEDs/each optic 1 Light colour White Required components: C12105_LENINA-STD-BASE-CXA20 C12606_LENINA-DL</p>		
<p>CREE ⇄ LED</p> <p>LED CXA2011 FWHM / FWTM 72.0° / 121.0° Efficiency 87 % Peak intensity 0.7 cd/lm LEDs/each optic 1 Light colour White Required components: C12105_LENINA-STD-BASE-CXA20</p>		

PHOTOMETRIC DATA (MEASURED):

EVERLIGHT

LED CHI3030 19W
 FWHM / FWTM 75.0° / 130.0°
 Efficiency 94 %
 Peak intensity 0.6 cd/lm
 LEDs/each optic 1
 Light colour White

Required components:

C13867_LENINA-STD-BASE-VERO29
 C12606_LENINA-DL
 Bender Wirth: 468 Typ L3



EVERLIGHT

LED CHI3030 29W
 FWHM / FWTM 75.0° / 128.0°
 Efficiency 90 %
 Peak intensity 0.5 cd/lm
 LEDs/each optic 1
 Light colour White

Required components:

C13867_LENINA-STD-BASE-VERO29
 C12606_LENINA-DL
 Bender Wirth: 468 Typ L3

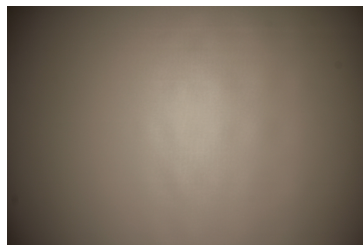

LUMILEDS

LED LUXEON CoB 1202/1203
 FWHM / FWTM 76.0° / 126.0°
 Efficiency 93 %
 Peak intensity 0.6 cd/lm
 LEDs/each optic 1
 Light colour White

Required components:

C13868_LENINA-STD-BASE-VERO13-18
 Bender Wirth: 438 Typ L1

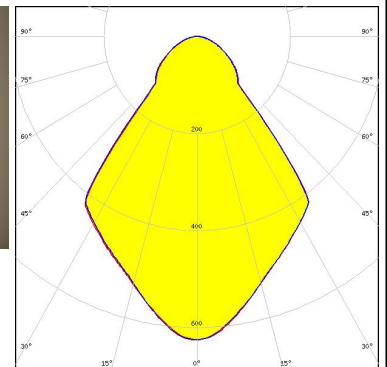
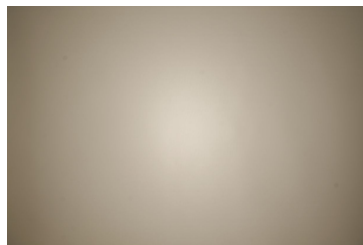

LUMILEDS

LED LUXEON CoB 1202/1203
 FWHM / FWTM 74.0° / 125.0°
 Efficiency 89 %
 Peak intensity 0.6 cd/lm
 LEDs/each optic 1
 Light colour White

Required components:

C13868_LENINA-STD-BASE-VERO13-18
 C12606_LENINA-DL
 Bender Wirth: 438 Typ L1

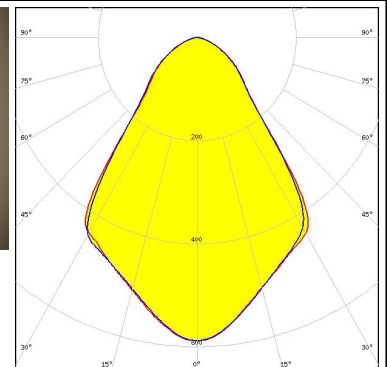



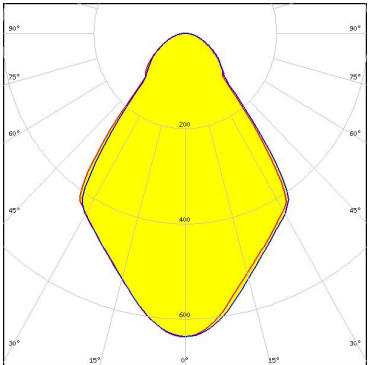
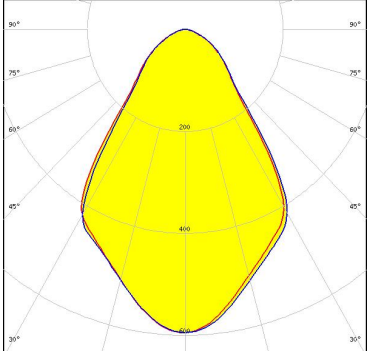
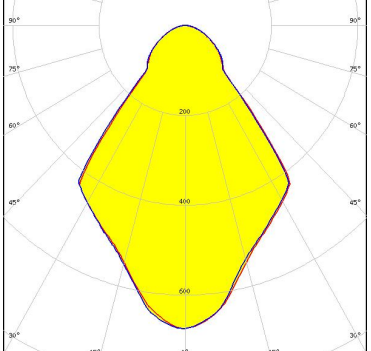
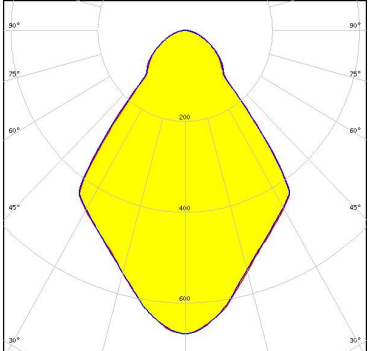

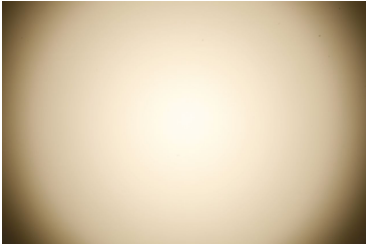
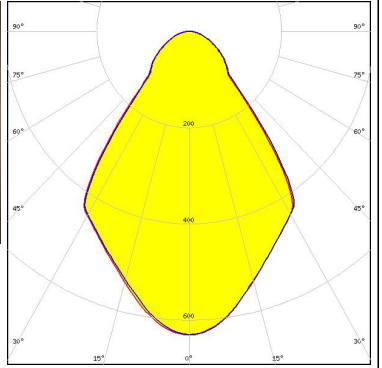
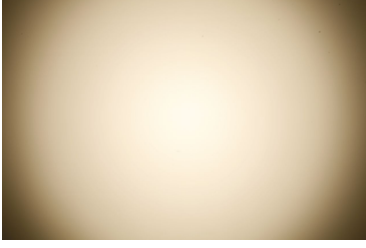
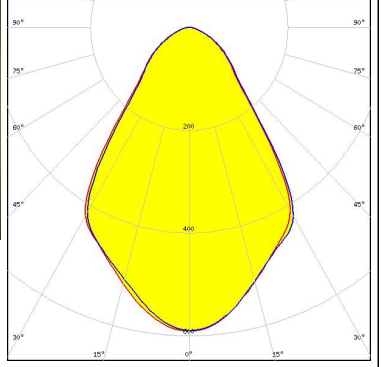
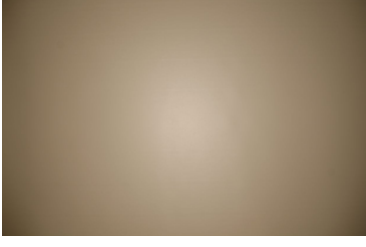
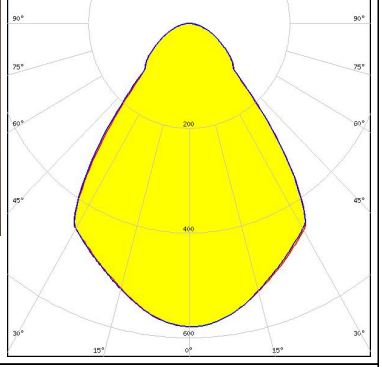
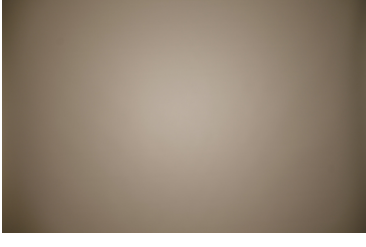
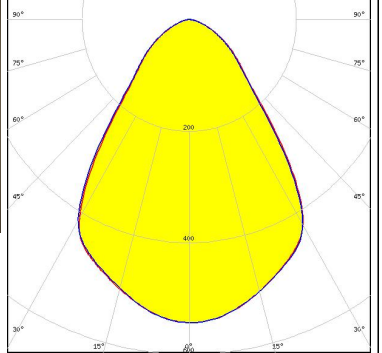

PHOTOMETRIC DATA (MEASURED):

<p>LUMILEDS</p> <p>LED LUXEON CoB 1204/1205</p> <p>FWHM / FWTM 73.0° / 123.0°</p> <p>Efficiency 90 %</p> <p>Peak intensity 0.6 cd/m</p> <p>LEDs/each optic 1</p> <p>Light colour White</p> <p>Required components: C12292_LENINA-STD-BASE-MEZ</p>	
<p>LUMILEDS</p> <p>LED LUXEON CoB 1204/1205</p> <p>FWHM / FWTM 71.0° / 123.0°</p> <p>Efficiency 86 %</p> <p>Peak intensity 0.6 cd/m</p> <p>LEDs/each optic 1</p> <p>Light colour White</p> <p>Required components: C12292_LENINA-STD-BASE-MEZ C12606_LENINA-DL</p>	
<p>LUMILEDS</p> <p>LED LUXEON CoB 1204HD</p> <p>FWHM / FWTM 74.0° / 122.0°</p> <p>Efficiency 94 %</p> <p>Peak intensity 0.7 cd/m</p> <p>LEDs/each optic 1</p> <p>Light colour White</p> <p>Required components: C11981_LENINA-STD-BASE-COB-L110</p>	
<p>LUMILEDS</p> <p>LED LUXEON CoB 1205HD</p> <p>FWHM / FWTM 74.0° / 122.0°</p> <p>Efficiency 94 %</p> <p>Peak intensity 0.7 cd/m</p> <p>LEDs/each optic 1</p> <p>Light colour White</p> <p>Required components: C11981_LENINA-STD-BASE-COB-L110</p>	

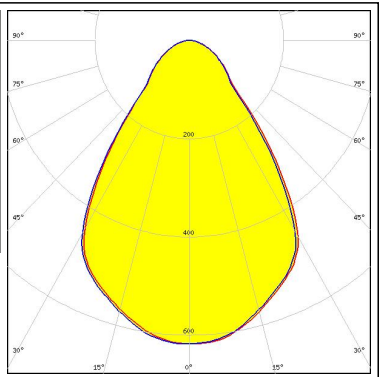
PHOTOMETRIC DATA (MEASURED):

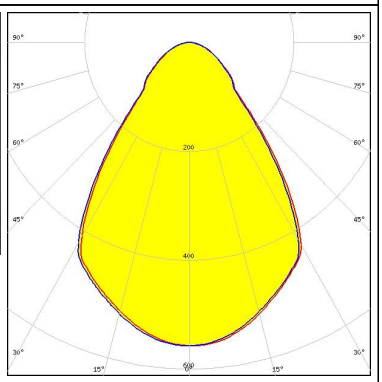
<p>LUMILEDS</p> <p>LED LUXEON CoB 1208</p> <p>FWHM / FWTM 73.0° / 123.0°</p> <p>Efficiency 91 %</p> <p>Peak intensity 0.6 cd/m</p> <p>LEDs/each optic 1</p> <p>Light colour White</p> <p>Required components: C12292_LENINA-STD-BASE-MEZ</p>		
<p>LUMILEDS</p> <p>LED LUXEON CoB 1208</p> <p>FWHM / FWTM 72.0° / 124.0°</p> <p>Efficiency 86 %</p> <p>Peak intensity 0.6 cd/m</p> <p>LEDs/each optic 1</p> <p>Light colour White</p> <p>Required components: C12292_LENINA-STD-BASE-MEZ C12606_LENINA-DL</p>		
<p>LUMILEDS</p> <p>LED LUXEON CoB 1211</p> <p>FWHM / FWTM 76.0° / 127.0°</p> <p>Efficiency 93 %</p> <p>Peak intensity 0.6 cd/m</p> <p>LEDs/each optic 1</p> <p>Light colour White</p> <p>Required components: C13867_LENINA-STD-BASE-VERO29 Bender Wirth: 431 Typ L3</p>		
<p>LUMILEDS</p> <p>LED LUXEON CoB 1211</p> <p>FWHM / FWTM 75.0° / 127.0°</p> <p>Efficiency 88 %</p> <p>Peak intensity 0.5 cd/m</p> <p>LEDs/each optic 1</p> <p>Light colour White</p> <p>Required components: C13867_LENINA-STD-BASE-VERO29 C12606_LENINA-DL Bender Wirth: 431 Typ L3</p>		

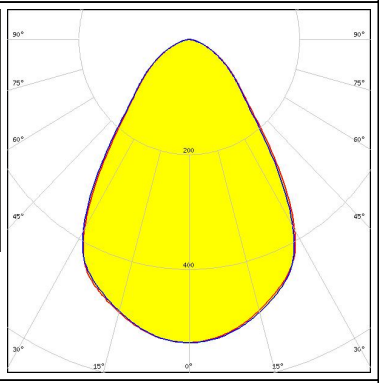
PHOTOMETRIC DATA (MEASURED):

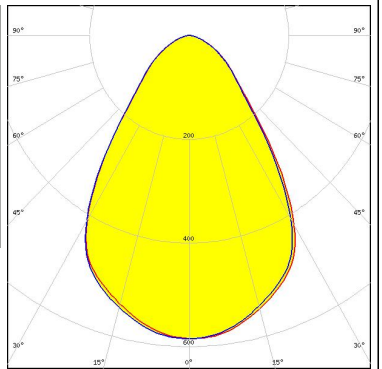
<p>LUMILEDS</p> <p>LED LUXEON CoB 1216/1812</p> <p>FWHM / FWTM 73.0° / 124.0°</p> <p>Efficiency 94 %</p> <p>Peak intensity 0.6 cd/lm</p> <p>LEDs/each optic 1</p> <p>Light colour White</p> <p>Required components: C12692_LENINA-STD-BASE-CLL040</p>		
<p>LUMILEDS</p> <p>LED LUXEON CoB 1216/1812</p> <p>FWHM / FWTM 74.0° / 127.0°</p> <p>Efficiency 88 %</p> <p>Peak intensity 0.6 cd/lm</p> <p>LEDs/each optic 1</p> <p>Light colour White</p> <p>Required components: A.A.G. STUCCHI: 8102-G2 + S-8000-12</p>		
<p>LUMILEDS</p> <p>LED LUXEON CoB 1216/1812</p> <p>FWHM / FWTM 73.0° / 126.0°</p> <p>Efficiency 83 %</p> <p>Peak intensity 0.5 cd/lm</p> <p>LEDs/each optic 1</p> <p>Light colour White</p> <p>Required components: C12606_LENINA-DL A.A.G. STUCCHI: 8102-G2 + S-8000-12</p>		
<p>LUMILEDS</p> <p>LED LUXEON CoB 1216/1812</p> <p>FWHM / FWTM 72.0° / 125.0°</p> <p>Efficiency 90 %</p> <p>Peak intensity 0.6 cd/lm</p> <p>LEDs/each optic 1</p> <p>Light colour White</p> <p>Required components: C12692_LENINA-STD-BASE-CLL040 C12606_LENINA-DL</p>		

PHOTOMETRIC DATA (MEASURED):

LUMILEDS

LED LUXEON K12
 FWHM / FWTM 72.0° / 115.0°
 Efficiency 90 %
 Peak intensity 0.7 cd/lm
 LEDs/each optic 1
 Light colour White
 Required components:
 C12924_LENASTD-BASE-LUXEON-K

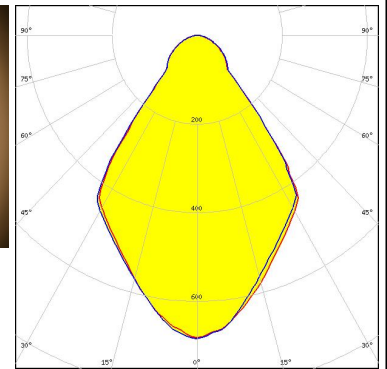

LUMILEDS

LED LUXEON K12
 FWHM / FWTM 68.0° / 118.0°
 Efficiency 83 %
 Peak intensity 0.6 cd/lm
 LEDs/each optic 1
 Light colour White
 Required components:
 C12924_LENASTD-BASE-LUXEON-K
 C12606_LENINA-DL

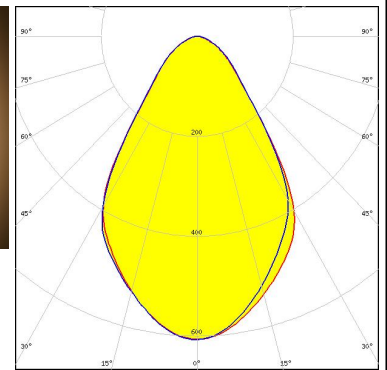
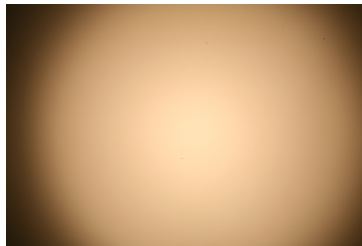

LUMILEDS

LED LUXEON K16
 FWHM / FWTM 72.0° / 116.0°
 Efficiency 86 %
 Peak intensity 0.6 cd/lm
 LEDs/each optic 1
 Light colour White
 Required components:
 C12924_LENASTD-BASE-LUXEON-K

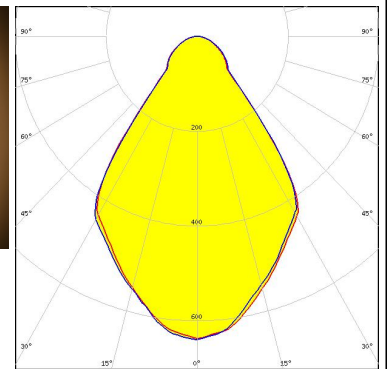
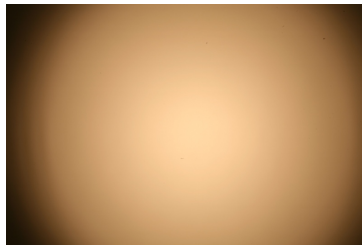



LUMILEDS

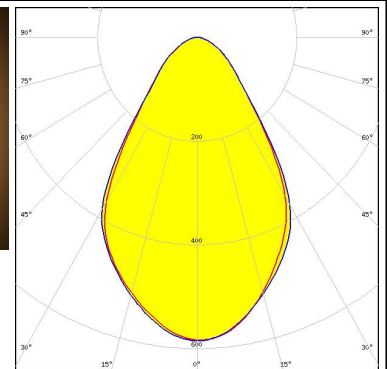
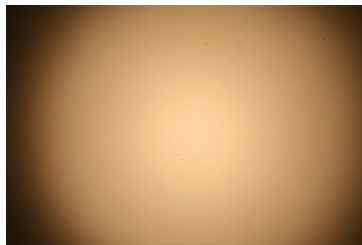



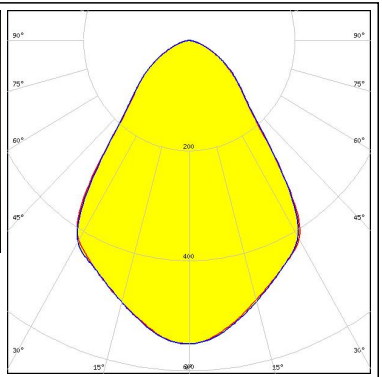
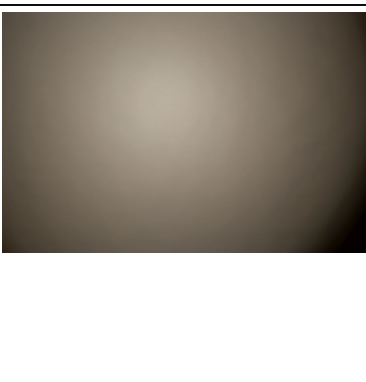
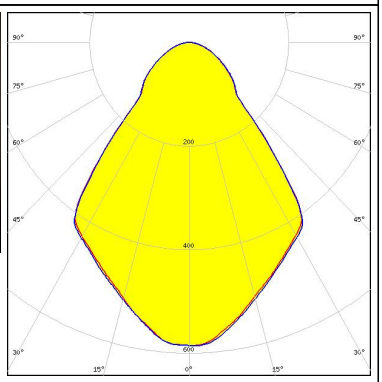
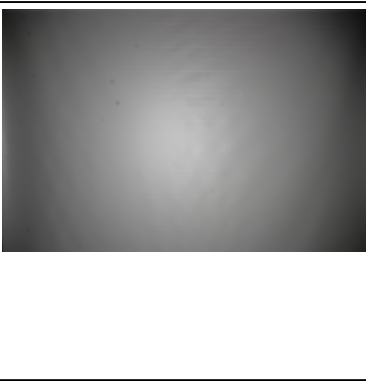
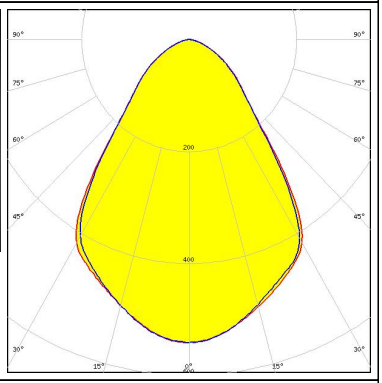

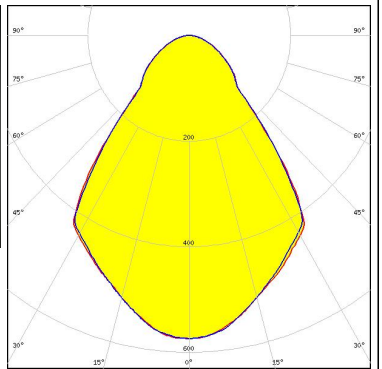
LED LUXEON K16
 FWHM / FWTM 68.0° / 120.0°
 Efficiency 80 %
 Peak intensity 0.6 cd/lm
 LEDs/each optic 1
 Light colour White
 Required components:
 C12924_LENASTD-BASE-LUXEON-K
 C12606_LENINA-DL

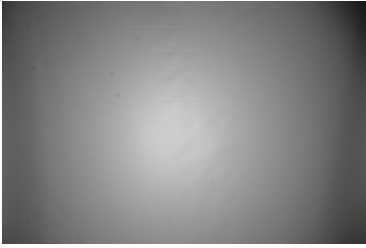
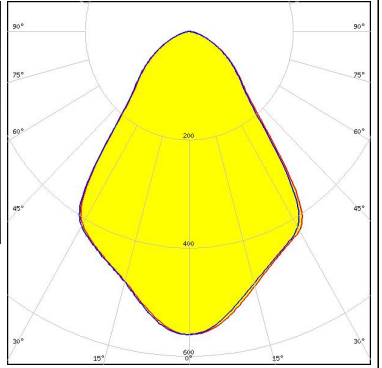

PHOTOMETRIC DATA (MEASURED):

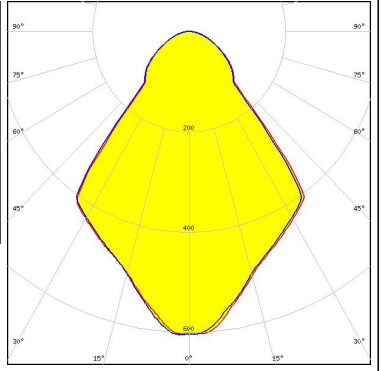
<p>LUMINUS</p> <p>LED CDM-14 (Dim-To-Warm)</p> <p>FWHM / FWTM 75.0° / 128.0°</p> <p>Efficiency 89 %</p> <p>Peak intensity 0.6 cd/lm</p> <p>LEDs/each optic 1</p> <p>Light colour White</p> <p>Required components: C13868_LENINA-STD-BASE-VERO13-18 C12606_LENINA-DL Bender Wirth: 491 Typ L2</p>		
<p>LUMINUS</p> <p>LED CDM-14 (Dim-To-Warm)</p> <p>FWHM / FWTM 77.0° / 129.0°</p> <p>Efficiency 93 %</p> <p>Peak intensity 0.6 cd/lm</p> <p>LEDs/each optic 1</p> <p>Light colour White</p> <p>Required components: C13868_LENINA-STD-BASE-VERO13-18 Bender Wirth: 491 Typ L2</p>		
<p>LUMINUS</p> <p>LED CDM-18 (Dim-To-Warm)</p> <p>FWHM / FWTM 75.0° / 128.0°</p> <p>Efficiency 89 %</p> <p>Peak intensity 0.5 cd/lm</p> <p>LEDs/each optic 1</p> <p>Light colour White</p> <p>Required components: C13868_LENINA-STD-BASE-VERO13-18 C12606_LENINA-DL Bender Wirth: 491 Typ L2</p>		
<p>LUMINUS</p> <p>LED CDM-18 (Dim-To-Warm)</p> <p>FWHM / FWTM 76.0° / 129.0°</p> <p>Efficiency 93 %</p> <p>Peak intensity 0.6 cd/lm</p> <p>LEDs/each optic 1</p> <p>Light colour White</p> <p>Required components: C13868_LENINA-STD-BASE-VERO13-18 Bender Wirth: 491 Typ L2</p>		

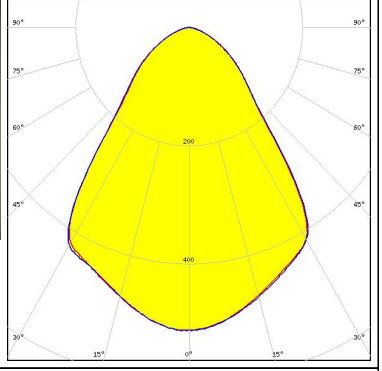

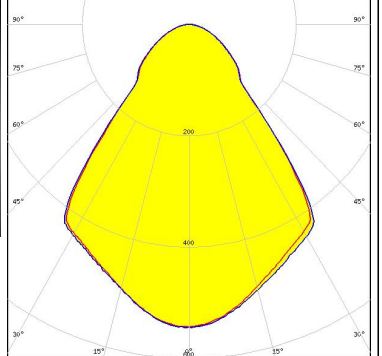

PHOTOMETRIC DATA (MEASURED):

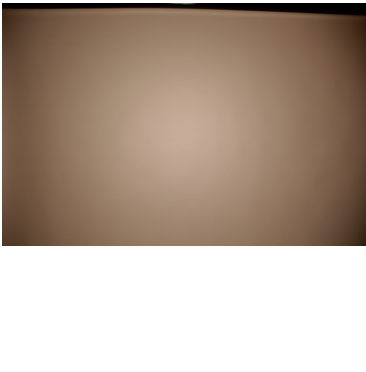
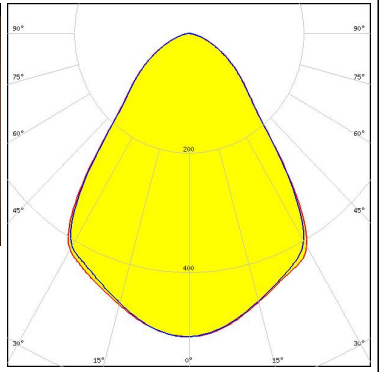
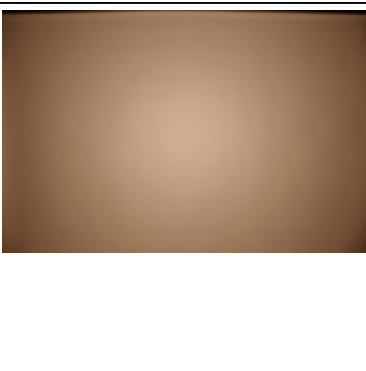
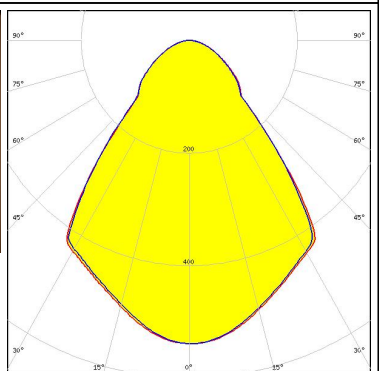
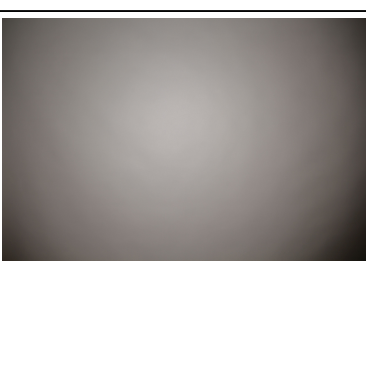
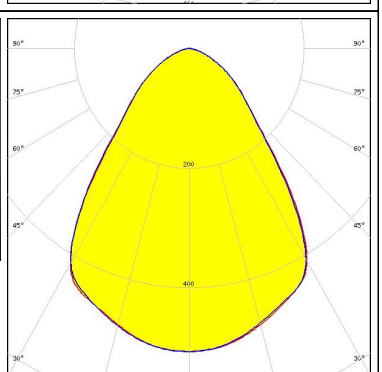
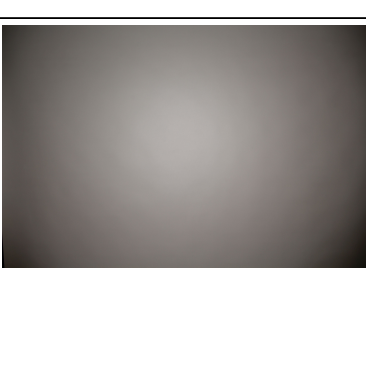
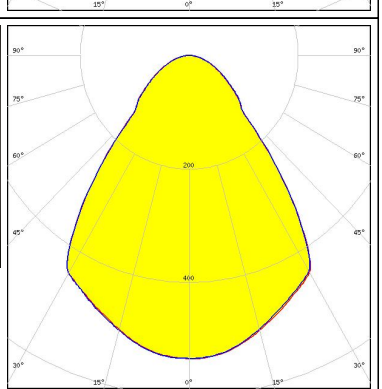
<p>LUMINUS</p> <p>LED CDM-9 (Dim-To-Warm)</p> <p>FWHM / FWTM 74.0° / 127.0°</p> <p>Efficiency 88 %</p> <p>Peak intensity 0.6 cd/lm</p> <p>LEDs/each optic 1</p> <p>Light colour White</p> <p>Required components: C13868_LENASTD-BASE-VERO13-18 Bender Wirth: 490 Typ L1</p>		
<p>LUMINUS</p> <p>LED CDM-9 (Dim-To-Warm)</p> <p>FWHM / FWTM 76.0° / 128.0°</p> <p>Efficiency 92 %</p> <p>Peak intensity 0.6 cd/lm</p> <p>LEDs/each optic 1</p> <p>Light colour White</p> <p>Required components: C13868_LENASTD-BASE-VERO13-18 Bender Wirth: 490 Typ L1</p>		
<p>LUMINUS</p> <p>LED CTM-14 (Tunable White)</p> <p>FWHM / FWTM 76.0° / 129.0°</p> <p>Efficiency 87 %</p> <p>Peak intensity 0.5 cd/lm</p> <p>LEDs/each optic 1</p> <p>Light colour White</p> <p>Required components: C13867_LENASTD-BASE-VERO29 C12606_LENINA-DL Bender Wirth: 442 Typ L3</p>		
<p>LUMINUS</p> <p>LED CTM-14 (Tunable White)</p> <p>FWHM / FWTM 77.0° / 131.0°</p> <p>Efficiency 92 %</p> <p>Peak intensity 0.6 cd/lm</p> <p>LEDs/each optic 1</p> <p>Light colour White</p> <p>Required components: C13867_LENASTD-BASE-VERO29 Bender Wirth: 442 Typ L3</p>		

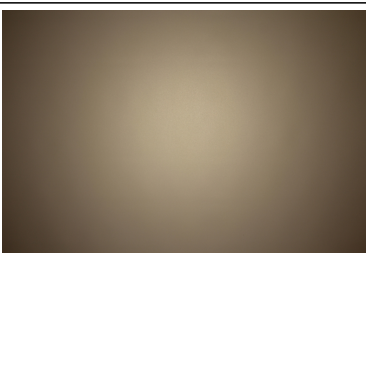
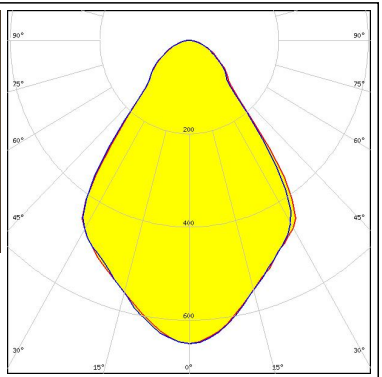

PHOTOMETRIC DATA (MEASURED):

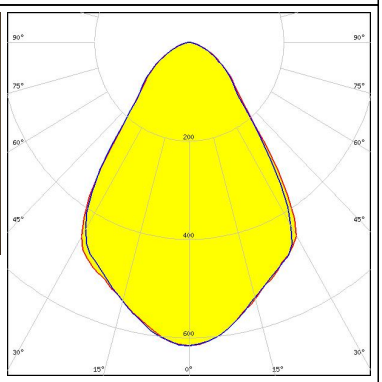
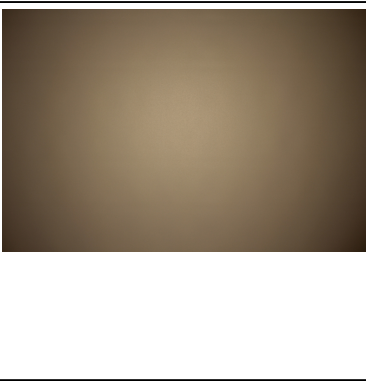
<p>LUMINUS</p> <p>LED CTM-18 (Tunable White) FWHM / FWTM 77.0° / 129.0° Efficiency 87 % Peak intensity 0.5 cd/lm LEDs/each optic 1 Light colour White</p> <p>Required components: C13867_LENINA-STD-BASE-VERO29 C12606_LENINA-DL Bender Wirth: 442 Typ L3</p>		
<p>LUMINUS</p> <p>LED CTM-18 (Tunable White) FWHM / FWTM 78.0° / 131.0° Efficiency 92 % Peak intensity 0.5 cd/lm LEDs/each optic 1 Light colour White</p> <p>Required components: C13867_LENINA-STD-BASE-VERO29 Bender Wirth: 442 Typ L3</p>		
<p>LUMINUS</p> <p>LED CTM-22 (Tunable White) FWHM / FWTM 77.0° / 129.0° Efficiency 88 % Peak intensity 0.5 cd/lm LEDs/each optic 1 Light colour White</p> <p>Required components: C13867_LENINA-STD-BASE-VERO29 C12606_LENINA-DL Bender Wirth: 494 Typ L3</p>		
<p>LUMINUS</p> <p>LED CTM-22 (Tunable White) FWHM / FWTM 78.0° / 131.0° Efficiency 92 % Peak intensity 0.5 cd/lm LEDs/each optic 1 Light colour White</p> <p>Required components: C13867_LENINA-STD-BASE-VERO29 Bender Wirth: 494 Typ L3</p>		

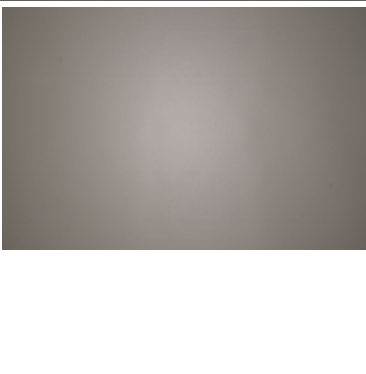
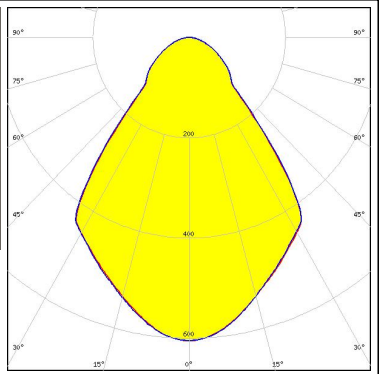

PHOTOMETRIC DATA (MEASURED):

<p>LUMINUS</p> <p>LED CxM-14 (19x19) FWHM / FWTM 74.0° / 124.0° Efficiency 94 % Peak intensity 0.7 cd/lm LEDs/each optic 1 Light colour White Required components: C12691_LENINA-STD-BASE-CLL030</p>		
<p>LUMINUS</p> <p>LED CxM-14 (19x19) FWHM / FWTM 73.0° / 125.0° Efficiency 91 % Peak intensity 0.6 cd/lm LEDs/each optic 1 Light colour White Required components: C12691_LENINA-STD-BASE-CLL030 C12606_LENINA-DL</p>		
<p>LUMINUS</p> <p>LED CxM-22 (28x28) FWHM / FWTM 73.0° / 128.0° Efficiency 91 % Peak intensity 0.6 cd/lm LEDs/each optic 1 Light colour White Required components: C12692_LENINA-STD-BASE-CLL040 C12606_LENINA-DL</p>		
<p>LUMINUS</p> <p>LED CxM-22 (28x28) FWHM / FWTM 73.0° / 128.0° Efficiency 94 % Peak intensity 0.6 cd/lm LEDs/each optic 1 Light colour White Required components: C12692_LENINA-STD-BASE-CLL040</p>		

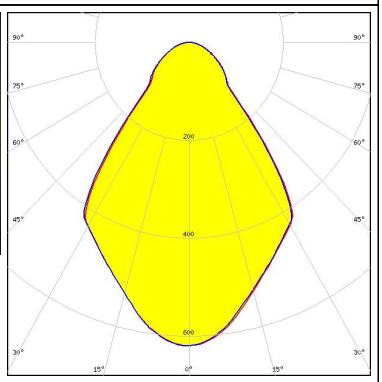
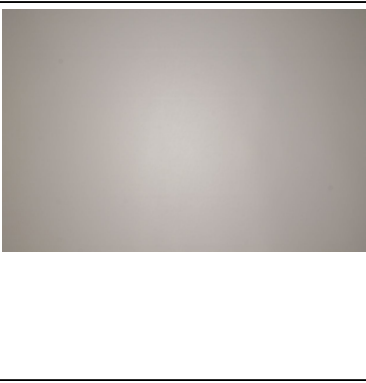
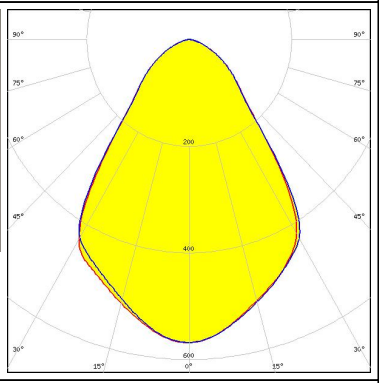
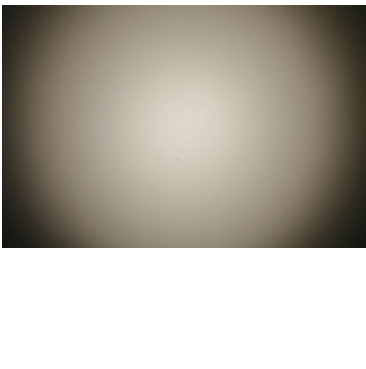
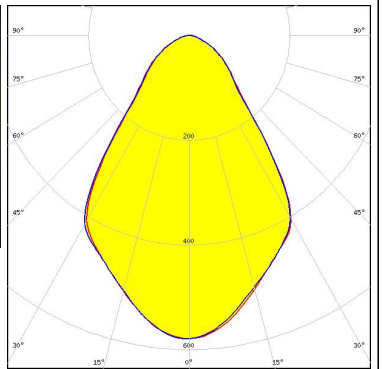

PHOTOMETRIC DATA (MEASURED):

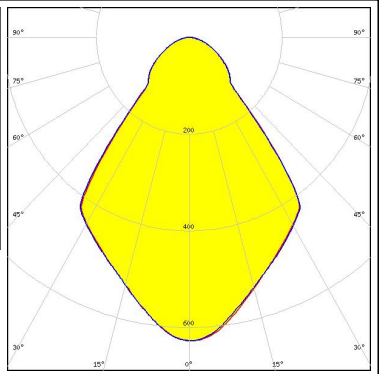
<p>NICHIA</p> <p>LED COB J-Type FWHM / FWTM 76.0° / 127.0° Efficiency 94 % Peak intensity 0.6 cd/lm LEDs/each optic 1 Light colour White</p> <p>Required components: C13868_LENINA-STD-BASE-VERO13-18 Bender Wirth: 463 Typ L2</p>		
<p>NICHIA</p> <p>LED COB J-Type FWHM / FWTM 73.0° / 123.0° Efficiency 89 % Peak intensity 0.6 cd/lm LEDs/each optic 1 Light colour White</p> <p>Required components: C12292_LENINA-STD-BASE-MEZ</p>		
<p>NICHIA</p> <p>LED COB J-Type FWHM / FWTM 74.0° / 126.0° Efficiency 89 % Peak intensity 0.6 cd/lm LEDs/each optic 1 Light colour White</p> <p>Required components: C13868_LENINA-STD-BASE-VERO13-18 C12606_LENINA-DL Bender Wirth: 463 Typ L2</p>		
<p>NICHIA</p> <p>LED COB J-Type FWHM / FWTM 72.0° / 124.0° Efficiency 84 % Peak intensity 0.6 cd/lm LEDs/each optic 1 Light colour White</p> <p>Required components: C12292_LENINA-STD-BASE-MEZ C12606_LENINA-DL</p>		

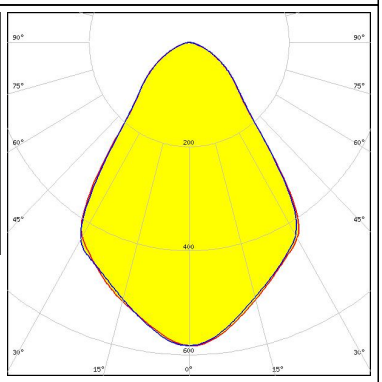
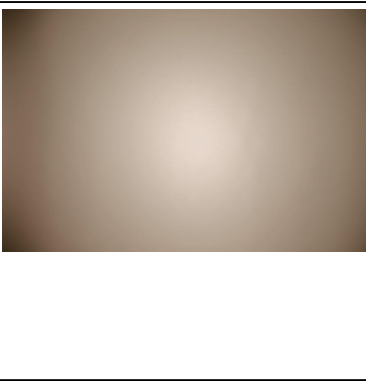
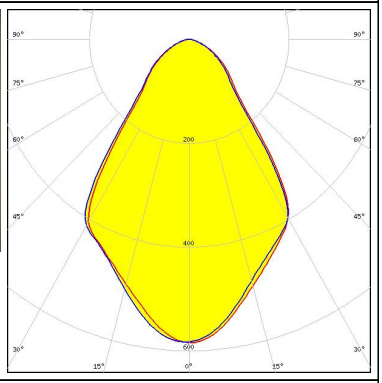
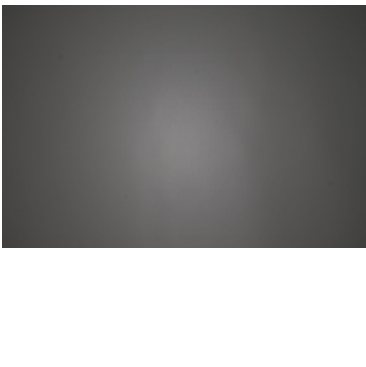
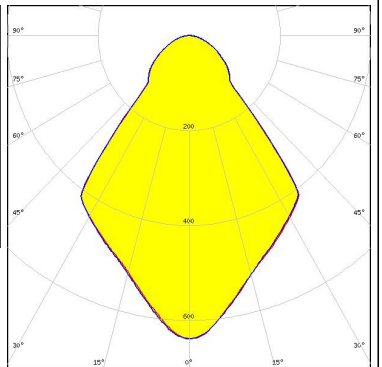
PHOTOMETRIC DATA (MEASURED):

<p>NICHIA</p> <p>LED COB L-Type (LES 11)</p> <p>FWHM / FWTM 75.0° / 125.0°</p> <p>Efficiency 93 %</p> <p>Peak intensity 0.6 cd/m</p> <p>LEDs/each optic 1</p> <p>Light colour White</p> <p>Required components: C13868_LENINA-STD-BASE-VERO13-18 Bender Wirth: 438 Typ L1</p>		
<p>NICHIA</p> <p>LED COB L-Type (LES 11)</p> <p>FWHM / FWTM 73.0° / 125.0°</p> <p>Efficiency 89 %</p> <p>Peak intensity 0.6 cd/m</p> <p>LEDs/each optic 1</p> <p>Light colour White</p> <p>Required components: C13868_LENINA-STD-BASE-VERO13-18 C12606_LENINA-DL Bender Wirth: 438 Typ L1</p>		
<p>NICHIA</p> <p>LED COB L-Type (LES 11)</p> <p>FWHM / FWTM 71.0° / 122.0°</p> <p>Efficiency 82 %</p> <p>Peak intensity 0.6 cd/m</p> <p>LEDs/each optic 1</p> <p>Light colour White</p> <p>Required components: C11981_LENINA-STD-BASE-COB-L110 C12606_LENINA-DL</p>		
<p>NICHIA</p> <p>LED COB L-Type (LES 9)</p> <p>FWHM / FWTM 76.0° / 126.0°</p> <p>Efficiency 94 %</p> <p>Peak intensity 0.6 cd/m</p> <p>LEDs/each optic 1</p> <p>Light colour White</p> <p>Required components: C13868_LENINA-STD-BASE-VERO13-18 Bender Wirth: 438 Typ L1</p>		

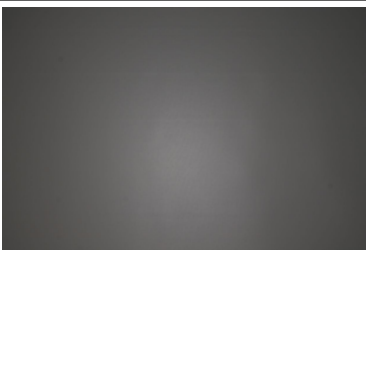
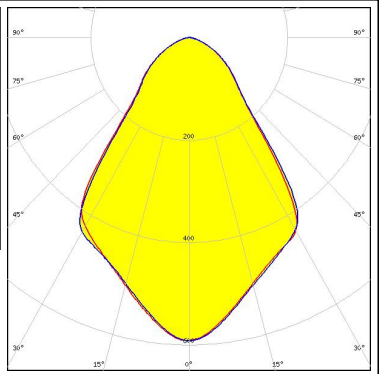
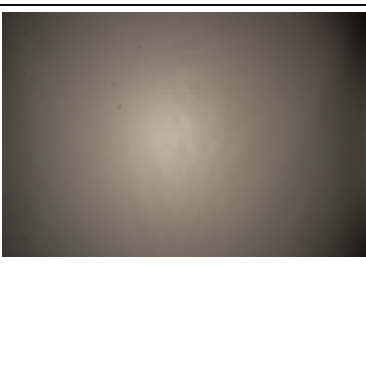
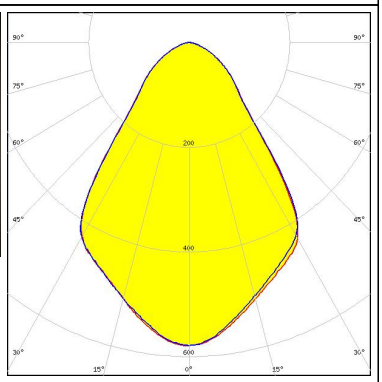
PHOTOMETRIC DATA (MEASURED):

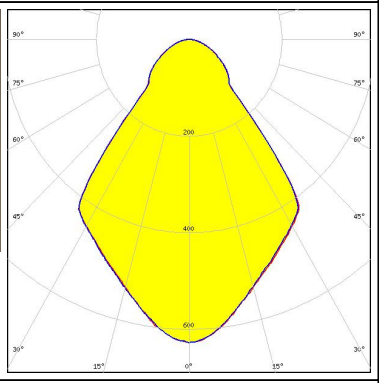
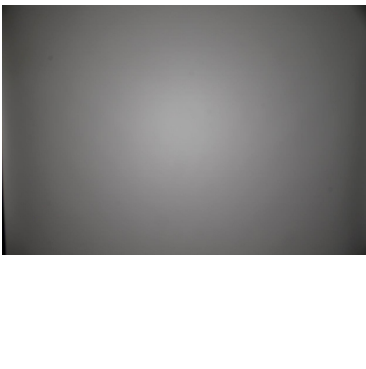
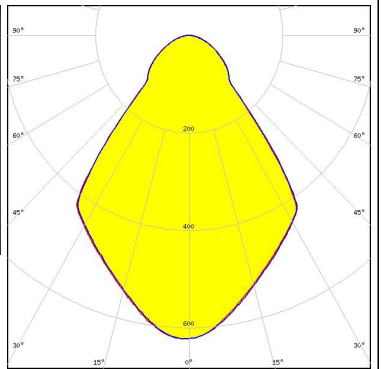
<p>NICHIA</p> <p>LED COB L-Type (LES 9)</p> <p>FWHM / FWTM 74.0° / 126.0°</p> <p>Efficiency 90 %</p> <p>Peak intensity 0.6 cd/m</p> <p>LEDs/each optic 1</p> <p>Light colour White</p> <p>Required components: C13868_LENINA-STD-BASE-VERO13-18 C12606_LENINA-DL Bender Wirth: 438 Typ L1</p>		
<p>NICHIA</p> <p>LED NVCWJ024Z-V1MT: COB J-Type Tunable White</p> <p>FWHM / FWTM 74.0° / 125.0°</p> <p>Efficiency 89 %</p> <p>Peak intensity 0.6 cd/m</p> <p>LEDs/each optic 1</p> <p>Light colour White</p> <p>Required components: C13868_LENINA-STD-BASE-VERO13-18 C12606_LENINA-DL Bender Wirth: 498 Typ L2</p>		
<p>NICHIA</p> <p>LED NVCWJ024Z-V1MT: COB J-Type Tunable White</p> <p>FWHM / FWTM 75.0° / 125.0°</p> <p>Efficiency 93 %</p> <p>Peak intensity 0.6 cd/m</p> <p>LEDs/each optic 1</p> <p>Light colour White</p> <p>Required components: C13868_LENINA-STD-BASE-VERO13-18 Bender Wirth: 498 Typ L2</p>		
<p>OSRAM <small>Opto Semiconductors</small></p> <p>LED Soleriq S13</p> <p>FWHM / FWTM 75.0° / 125.0°</p> <p>Efficiency 93 %</p> <p>Peak intensity 0.6 cd/m</p> <p>LEDs/each optic 1</p> <p>Light colour White</p> <p>Required components: C13868_LENINA-STD-BASE-VERO13-18 Bender Wirth: 437 Typ L1</p>		

PHOTOMETRIC DATA (MEASURED):

OSRAM

Opto Semiconductors

LED Soleriq S13
 FWHM / FWTM 73.0° / 126.0°
 Efficiency 89 %
 Peak intensity 0.6 cd/m
 LEDs/each optic 1
 Light colour White

Required components:

C13868_LENINA-STD-BASE-VERO13-18
 C12606_LENINA-DL
 Bender Wirth: 437 Typ L1

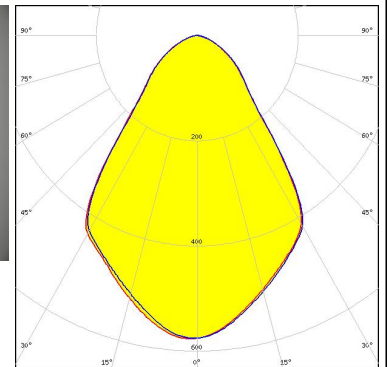
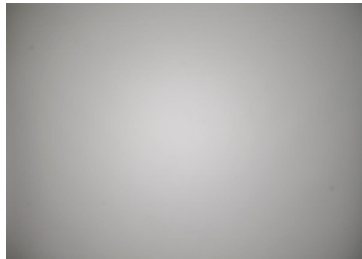

OSRAM

Opto Semiconductors

LED Soleriq S19
 FWHM / FWTM 76.0° / 131.0°
 Efficiency 93 %
 Peak intensity 0.6 cd/m
 LEDs/each optic 1
 Light colour White

Required components:

C13867_LENINA-STD-BASE-VERO29
 Bender Wirth: 462 Typ L3

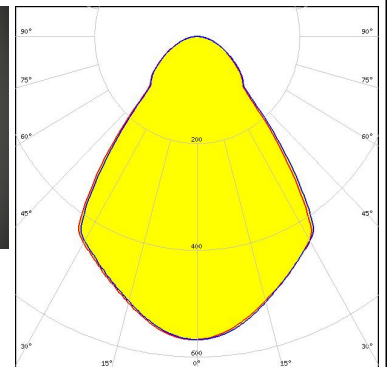
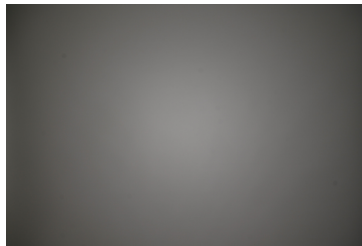

OSRAM

Opto Semiconductors

LED Soleriq S19
 FWHM / FWTM 75.0° / 127.0°
 Efficiency 88 %
 Peak intensity 0.6 cd/m
 LEDs/each optic 1
 Light colour White

Required components:

C13867_LENINA-STD-BASE-VERO29
 C12606_LENINA-DL
 Bender Wirth: 462 Typ L3

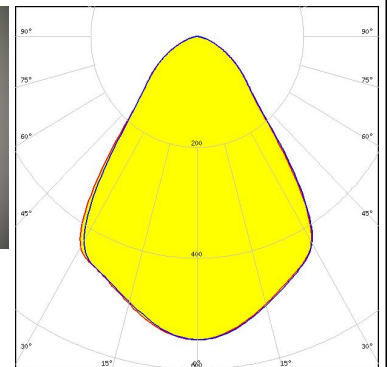

PHILIPS

LED Fortimo SLM L13 CoB
 FWHM / FWTM 71.0° / 122.0°
 Efficiency 88 %
 Peak intensity 0.6 cd/m
 LEDs/each optic 1
 Light colour White

Required components:

C12292_LENINA-STD-BASE-MEZ
 C12606_LENINA-DL

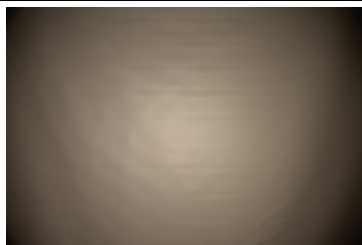

PHOTOMETRIC DATA (MEASURED):

PHILIPS

LED Fortimo SLM L13 CoB
 FWHM / FWTM 74.0° / 123.0°
 Efficiency 94 %
 Peak intensity 0.7 cd/lm
 LEDs/each optic 1
 Light colour White
 Required components:
 C12292_LENASTD-BASE-MEZ

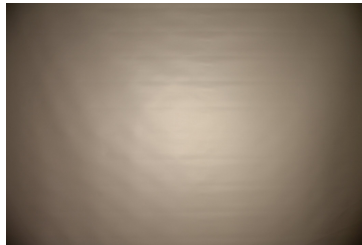

PHILIPS

LED Fortimo SLM L15 CoB
 FWHM / FWTM 72.0° / 123.0°
 Efficiency 88 %
 Peak intensity 0.6 cd/lm
 LEDs/each optic 1
 Light colour White
 Required components:
 C12292_LENASTD-BASE-MEZ
 C12606_LENINA-DL

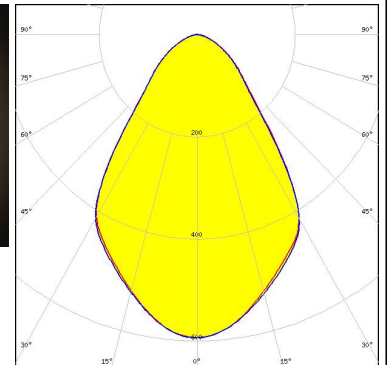
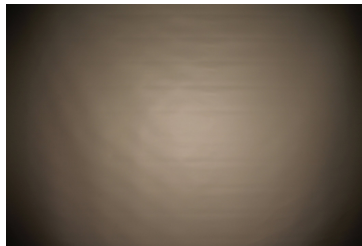

PHILIPS

LED Fortimo SLM L15 CoB
 FWHM / FWTM 73.0° / 123.0°
 Efficiency 93 %
 Peak intensity 0.7 cd/lm
 LEDs/each optic 1
 Light colour White
 Required components:
 C12292_LENASTD-BASE-MEZ

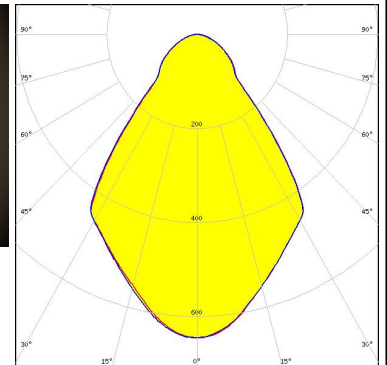
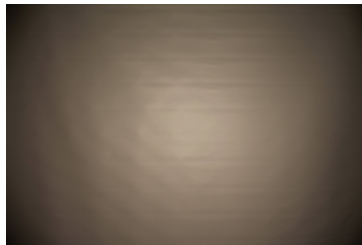

PHILIPS

LED Fortimo SLM L19 CoB
 FWHM / FWTM 72.0° / 122.0°
 Efficiency 94 %
 Peak intensity 0.7 cd/lm
 LEDs/each optic 1
 Light colour White
 Required components:
 C12692_LENASTD-BASE-CLL040

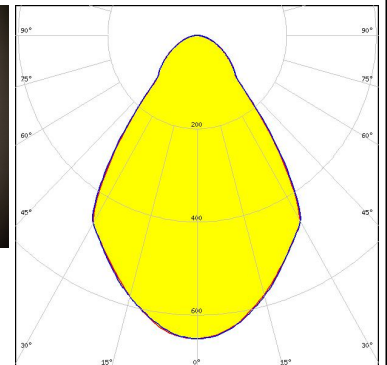
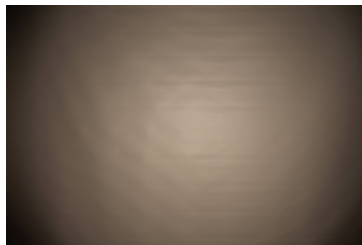

PHOTOMETRIC DATA (MEASURED):

PHILIPS

LED Fortimo SLM L19 CoB
 FWHM / FWTM 71.0° / 122.0°
 Efficiency 88 %
 Peak intensity 0.6 cd/lm
 LEDs/each optic 1
 Light colour White
 Required components:
 C12692_LENINA-STD-BASE-CLL040
 C12606_LENINA-DL

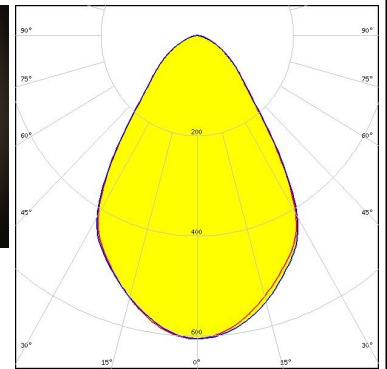
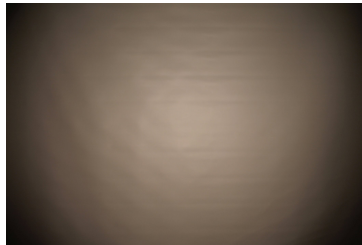

PHILIPS

LED Fortimo SLM L23 CoB
 FWHM / FWTM 72.0° / 122.0°
 Efficiency 94 %
 Peak intensity 0.6 cd/lm
 LEDs/each optic 1
 Light colour White
 Required components:
 C12692_LENINA-STD-BASE-CLL040

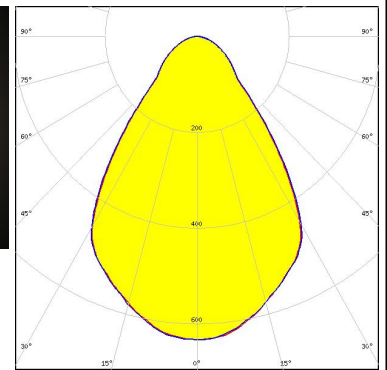
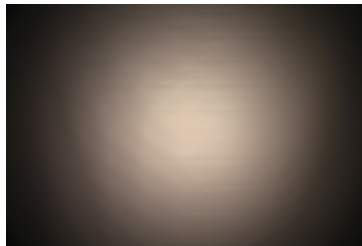

PHILIPS

LED Fortimo SLM L23 CoB
 FWHM / FWTM 71.0° / 122.0°
 Efficiency 88 %
 Peak intensity 0.6 cd/lm
 LEDs/each optic 1
 Light colour White
 Required components:
 C12692_LENINA-STD-BASE-CLL040
 C12606_LENINA-DL

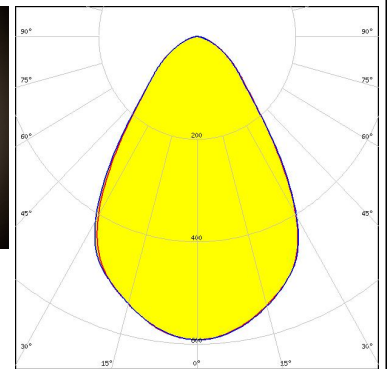
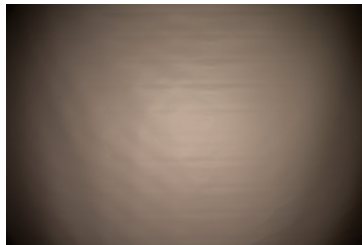

SAMSUNG

LED LC016D / LC019D / LC026D / LC033D
 FWHM / FWTM 73.0° / 125.0°
 Efficiency 89 %
 Peak intensity 0.6 cd/lm
 LEDs/each optic 1
 Light colour White
 Required components:
 C12691_LENINA-STD-BASE-CLL030
 C12606_LENINA-DL

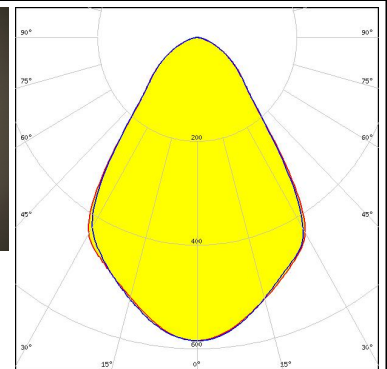
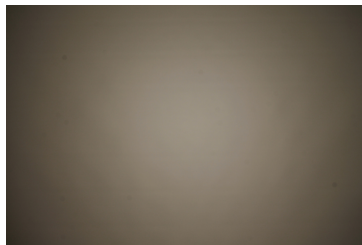

PHOTOMETRIC DATA (MEASURED):

SAMSUNG

LED LC016D / LC019D / LC026D / LC033D
 FWHM / FWTM 74.0° / 125.0°
 Efficiency 94 %
 Peak intensity 0.6 cd/m
 LEDs/each optic 1
 Light colour White
 Required components:
 C12691_LENINA-STD-BASE-CLL030

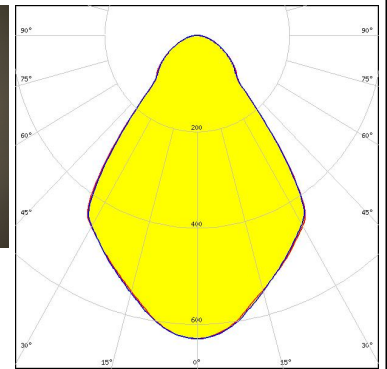
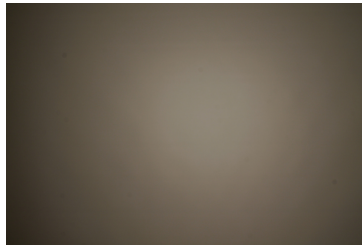

SAMSUNG

LED LC026B / 033B / 040B
 FWHM / FWTM 74.0° / 126.0°
 Efficiency 90 %
 Peak intensity 0.6 cd/m
 LEDs/each optic 1
 Light colour White
 Required components:
 C13868_LENINA-STD-BASE-VERO13-18
 C12606_LENINA-DL
 Bender Wirth: 450 Typ L2

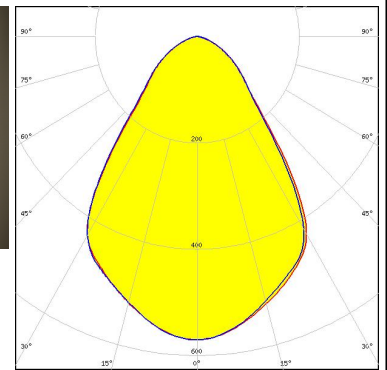
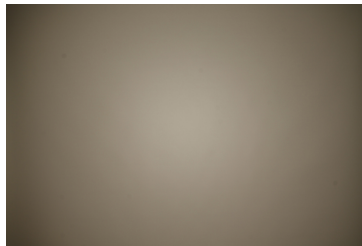

SAMSUNG

LED LC026B / 033B / 040B
 FWHM / FWTM 75.0° / 126.0°
 Efficiency 94 %
 Peak intensity 0.6 cd/m
 LEDs/each optic 1
 Light colour White
 Required components:
 C13868_LENINA-STD-BASE-VERO13-18
 Bender Wirth: 450 Typ L2

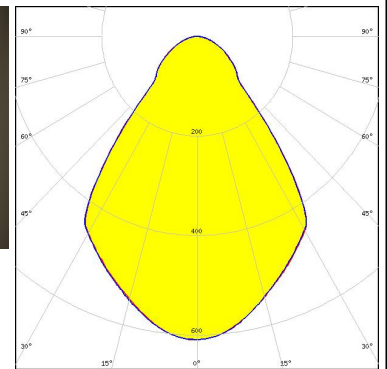
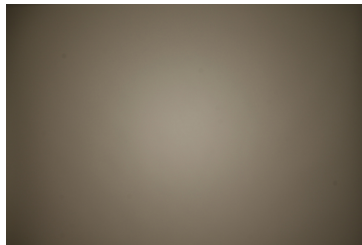



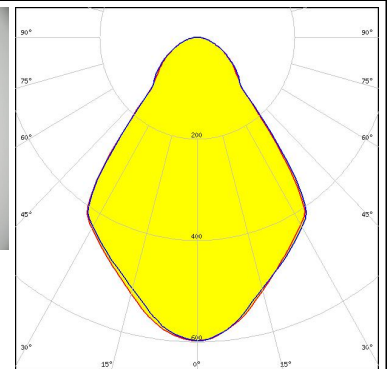
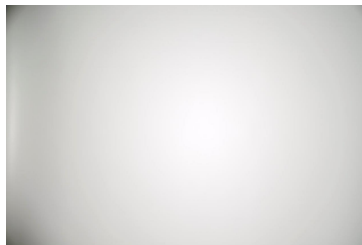

SEOUL SEMICONDUCTOR

LED ZC12/18
 FWHM / FWTM 75.0° / 126.0°
 Efficiency 90 %
 Peak intensity 0.6 cd/m
 LEDs/each optic 1
 Light colour White
 Required components:
 C12691_LENINA-STD-BASE-CLL030

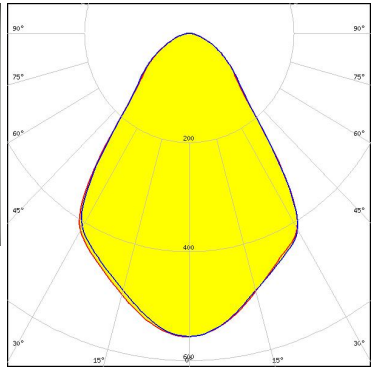

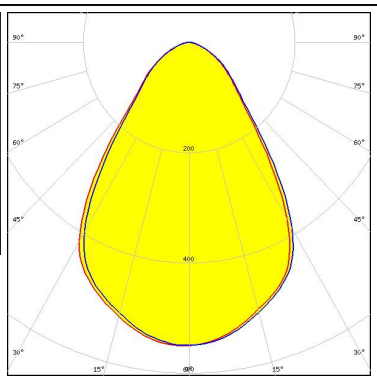
PHOTOMETRIC DATA (MEASURED):

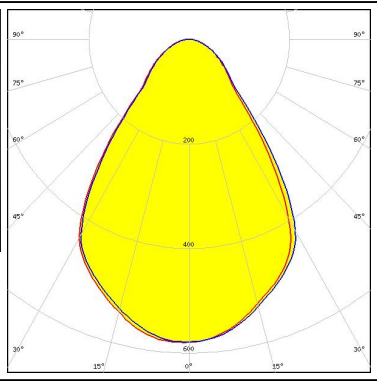
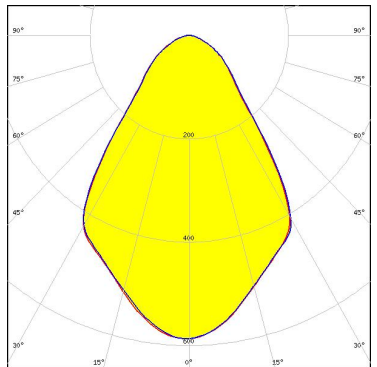
<p>SEOUL SEMICONDUCTOR</p> <p>LED ZC12/18</p> <p>FWHM / FWTM 73.0° / 126.0°</p> <p>Efficiency 86 %</p> <p>Peak intensity 0.6 cd/m</p> <p>LEDs/each optic 1</p> <p>Light colour White</p> <p>Required components:</p> <p>C12691_LENINA-STD-BASE-CLL030</p> <p>C12606_LENINA-DL</p>		
<p>SEOUL SEMICONDUCTOR</p> <p>LED ZC25/40/60</p> <p>FWHM / FWTM 72.0° / 125.0°</p> <p>Efficiency 85 %</p> <p>Peak intensity 0.6 cd/m</p> <p>LEDs/each optic 1</p> <p>Light colour White</p> <p>Required components:</p> <p>C12692_LENINA-STD-BASE-CLL040</p> <p>C12606_LENINA-DL</p>		
<p>SEOUL SEMICONDUCTOR</p> <p>LED ZC25/40/60</p> <p>FWHM / FWTM 73.0° / 125.0°</p> <p>Efficiency 89 %</p> <p>Peak intensity 0.6 cd/m</p> <p>LEDs/each optic 1</p> <p>Light colour White</p> <p>Required components:</p> <p>C12692_LENINA-STD-BASE-CLL040</p>		
<p>SHARP</p> <p>LED Mega Zenigata (GW5DGC)</p> <p>FWHM / FWTM 72.0° / 124.0°</p> <p>Efficiency 86 %</p> <p>Peak intensity 0.6 cd/m</p> <p>LEDs/each optic 1</p> <p>Light colour White</p> <p>Required components:</p> <p>C12292_LENINA-STD-BASE-MEZ</p> <p>C12606_LENINA-DL</p>		

PHOTOMETRIC DATA (MEASURED):

SHARP

LED Mega Zenigata (GW5DGC)
 FWHM / FWTM 73.0° / 123.0°
 Efficiency 90 %
 Peak intensity 0.6 cd/lm
 LEDs/each optic 1
 Light colour White
 Required components:
 C12292_LENINA-STD-BASE-MEZ

SHARP

LED Mega Zenigata (GW6DME)
 FWHM / FWTM 73.0° / 123.0°
 Efficiency 89 %
 Peak intensity 0.6 cd/lm
 LEDs/each optic 1
 Light colour White
 Required components:
 C12292_LENINA-STD-BASE-MEZ

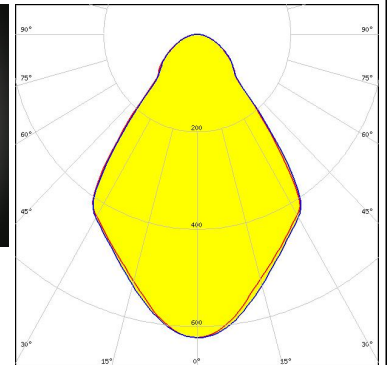
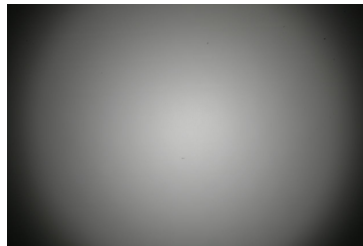

SHARP

LED Mega Zenigata (GW6DME)
 FWHM / FWTM 72.0° / 124.0°
 Efficiency 85 %
 Peak intensity 0.6 cd/lm
 LEDs/each optic 1
 Light colour White
 Required components:
 C12292_LENINA-STD-BASE-MEZ
 C12606_LENINA-DL

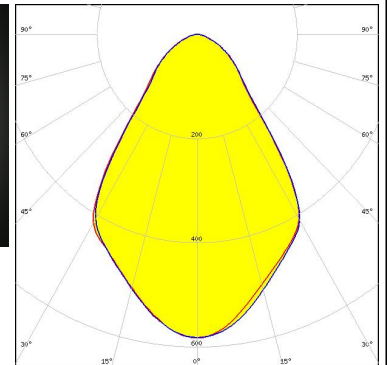
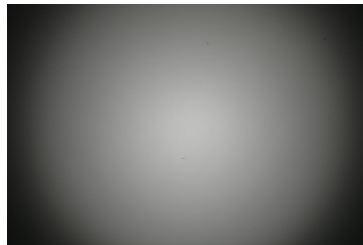

TRIDONIC

LED SLE G7 LES15
 FWHM / FWTM 73.0° / 125.0°
 Efficiency 90 %
 Peak intensity 0.6 cd/lm
 LEDs/each optic 1
 Light colour White
 Required components:
 C12691_LENINA-STD-BASE-CLL030

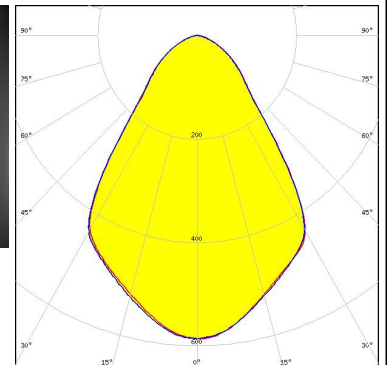
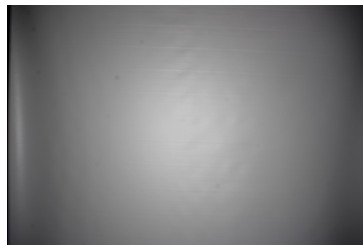

PHOTOMETRIC DATA (MEASURED):

TRIDONIC

LED SLE G7 LES17 H
 FWHM / FWTM 74.0° / 126.0°
 Efficiency 89 %
 Peak intensity 0.6 cd/lm
 LEDs/each optic 1
 Light colour White
 Required components:
 C14547_LENNA-ADAPTER-B

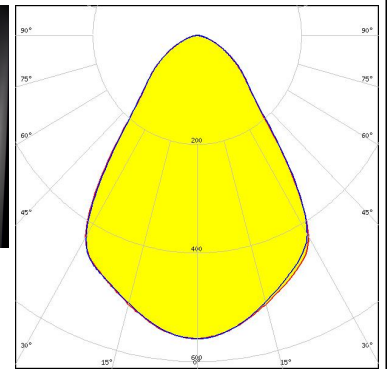
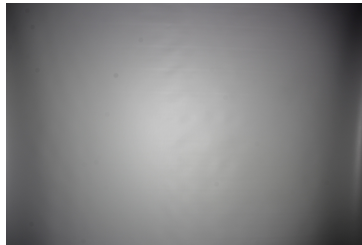

TRIDONIC

LED SLE G7 LES21 H
 FWHM / FWTM 74.0° / 127.0°
 Efficiency 93 %
 Peak intensity 0.6 cd/lm
 LEDs/each optic 1
 Light colour White
 Required components:
 C14547_LENNA-ADAPTER-B

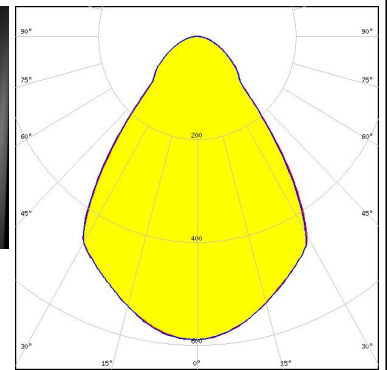
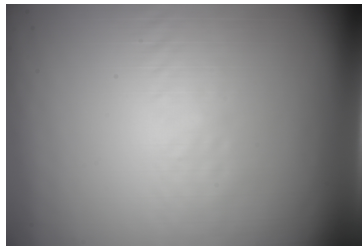

XICATO



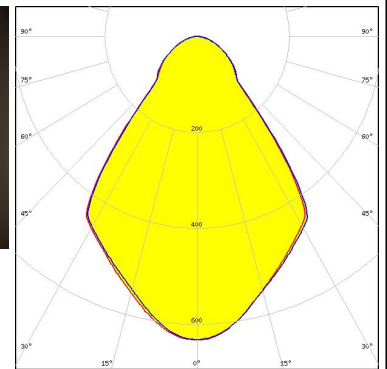
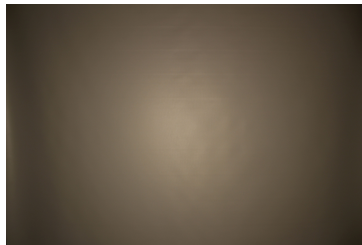

LED XOB 14.5 mm
 FWHM / FWTM 74.0° / 124.0°
 Efficiency 94 %
 Peak intensity 0.6 cd/lm
 LEDs/each optic 1
 Light colour White
 Required components:
 C12691_LENNA-STD-BASE-CLL030

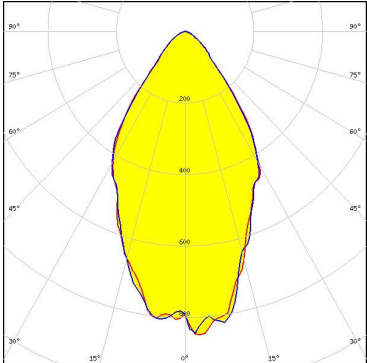

PHOTOMETRIC DATA (SIMULATED):

<p></p> <p>LED V10 Gen7 FWHM / FWTM 71.0° / 115.0° Efficiency 86 % Peak intensity 0.7 cd/lm LEDs/each optic 1 Light colour White Required components: C13868_LENINA-STD-BASE-VERO13-18 Bender Wirth: 486 Typ L1</p>	
<p></p> <p>LED V13 Gen7 FWHM / FWTM 70.0° / 119.0° Efficiency 83 % Peak intensity 0.6 cd/lm LEDs/each optic 1 Light colour White Required components: C12606_LENINA-DL IDEAL: 50-2103CT + 50-2100AN</p>	
<p></p> <p>LED V13 Gen7 FWHM / FWTM 72.0° / 121.0° Efficiency 82 % Peak intensity 0.6 cd/lm LEDs/each optic 1 Light colour White Required components: C13868_LENINA-STD-BASE-VERO13-18 C12606_LENINA-DL Bender Wirth: 477 Typ L1</p>	
<p></p> <p>LED V13 Gen7 FWHM / FWTM 73.0° / 121.0° Efficiency 86 % Peak intensity 0.6 cd/lm LEDs/each optic 1 Light colour White Required components: C13868_LENINA-STD-BASE-VERO13-18 Bender Wirth: 477 Typ L1</p>	

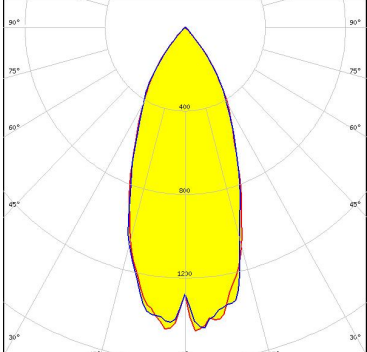
PHOTOMETRIC DATA (SIMULATED):

<p></p> <p>LED V22 Gen7 FWHM / FWTM 60.0° / 96.0° Efficiency 85 % Peak intensity 0.9 cd/lm LEDs/each optic 1 Light colour White</p> <p>Required components: C13867_LENINA-STD-BASE-VERO29 C12606_LENINA-DL Bender Wirth: 431 Typ L3</p>	
<p></p> <p>LED V22 Gen7 FWHM / FWTM 60.0° / 94.0° Efficiency 89 % LEDs/each optic 1 Light colour White</p> <p>Required components: C13867_LENINA-STD-BASE-VERO29 Bender Wirth: 431 Typ L3</p>	
<p></p> <p>LED CxM-14 (19x19) FWHM / FWTM 74.0° / 125.0° Efficiency 89 % Peak intensity 0.6 cd/lm LEDs/each optic 1 Light colour White</p> <p>Required components: C13868_LENINA-STD-BASE-VERO13-18 C12606_LENINA-DL Bender Wirth: 433 Typ L1</p>	
<p></p> <p>LED CxM-14 (19x19) FWHM / FWTM 75.0° / 126.0° Efficiency 94 % Peak intensity 0.6 cd/lm LEDs/each optic 1 Light colour White</p> <p>Required components: C13868_LENINA-STD-BASE-VERO13-18 Bender Wirth: 433 Typ L1</p>	

PHOTOMETRIC DATA (SIMULATED):



LED CxM-9 (13.5x13.5)
FWHM / FWTM 73.0° / 125.0°
Efficiency 89 %
Peak intensity 0.6 cd/lm
LEDs/each optic 1
Light colour White
Required components:
C13868_LENINA-STD-BASE-VERO13-18
C12606_LENINA-DL
Bender Wirth: 434 Typ L1



LED Soleriq S15
FWHM / FWTM 72.0° / 119.0°
Efficiency 87 %
Peak intensity 0.7 cd/lm
LEDs/each optic 1
Light colour White
Required components:
C12691_LENINA-STD-BASE-CLL030

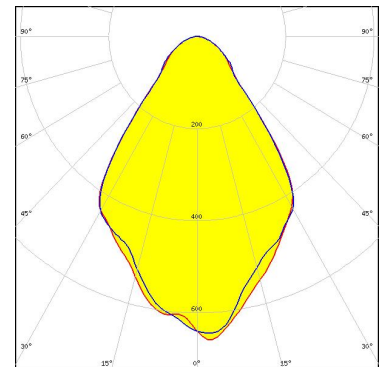

SEOUL SEMICONDUCTOR

LED ZC12/18
FWHM / FWTM 74.0° / 125.0°
Efficiency 89 %
Peak intensity 0.6 cd/lm
LEDs/each optic 1
Light colour White
Required components:
C13868_LENINA-STD-BASE-VERO13-18
C12606_LENINA-DL
Bender Wirth: 433 Typ L1



SEOUL SEMICONDUCTOR

LED ZC12/18
FWHM / FWTM 75.0° / 126.0°
Efficiency 94 %
Peak intensity 0.6 cd/lm
LEDs/each optic 1
Light colour White
Required components:
C13868_LENINA-STD-BASE-VERO13-18
Bender Wirth: 433 Typ L1

PHOTOMETRIC DATA (SIMULATED):

 SEOL SEMICONDUCTOR	
LED	ZC4/6
FWHM / FWTM	73.0° / 125.0°
Efficiency	89 %
Peak intensity	0.6 cd/lm
LEDs/each optic	1
Light colour	White
Required components:	
C13868_LENINA-STD-BASE-VERO13-18	
C12606_LENINA-DL	
Bender Wirth: 434 Typ L1	

GENERAL INFORMATION:

NOTE: The typical beam angle will be changed by different color, chip size and chip position tolerance. The typical total beam angle is the full angle measured where the luminous intensity is half of the peak value.

Due to use of high power COB's with this product, special attention to proper thermal design is highly recommended. LEDiL has no liability for direct, indirect or consecutive damages arising from the LEDiL products being used outside of the recommended temperature range.

MATERIALS:

As part of our continuous research and improvement processes, and to ensure the best possible quality and availability of our products, LEDiL reserves the right to change material grades without notice.

PRODUCT DATA USER AGREEMENT AND DISCLAIMER:

The measured data in the provided downloadable LEDiL Product Datasheets and Mechanical 2D-Drawings is rounded and provided as reference for planning. LEDiL Oy's optical specifications have been verified by conducting performance testing of the products in accordance with the company's quality system. The reported data are averaged results of multiple measurements with typical variation. LEDiL Oy reserves the right to without prior notification make changes and improvements to its products.

LEDiL Oy assumes neither warranty, nor guarantee nor any other liability of any kind for the contents and correctness of the provided data. The provided data has been generated with highest diligence but the provided data may in reality not represent the complete possible variation range of all intrinsic parameters. Therefore, in certain cases a deviation from the provided data could occur.

LEDiL Oy reserves the right to undertake technical changes of its products without further notification which could lead to changes in the provided data. LEDiL Oy assumes no liability of any kind for the possible deviation from any provided data or any other damage resulting from the usage of the provided data.

The user agrees to this disclaimer and user agreement with the download or usage of the provided files.

LEDiL Oy

Joensuunkatu 13
FI-24240 SALO
Finland

LEDiL Inc.

228 West Page Street
Suite D
Sycamore IL 60178
USA

Ledil Optics Technology (Shenzhen) Co., Ltd.

405 , Block B
Casic Motor Building
Shenzhen 518057
P.R.CHINA

Local sales and technical support

[www.ledil.com/
where_to_buy](http://www.ledil.com/where_to_buy)

Shipping locations

Salo, Finland
Hong Kong, China

Distribution Partners

[www.ledil.com/
where_to_buy](http://www.ledil.com/where_to_buy)