

HB-2X2-ON

~15° + 50° oval beam

TECHNICAL SPECIFICATIONS:

Dimensions	50.0 x 50.0 mm
Height	10 mm
Fastening	screw
ROHS compliant	yes ⓘ

MATERIAL SPECIFICATIONS:

Component	Type	Material	Colour	Finish
HB-2X2-ON	Multi-lens	PMMA	clear	

ORDERING INFORMATION:





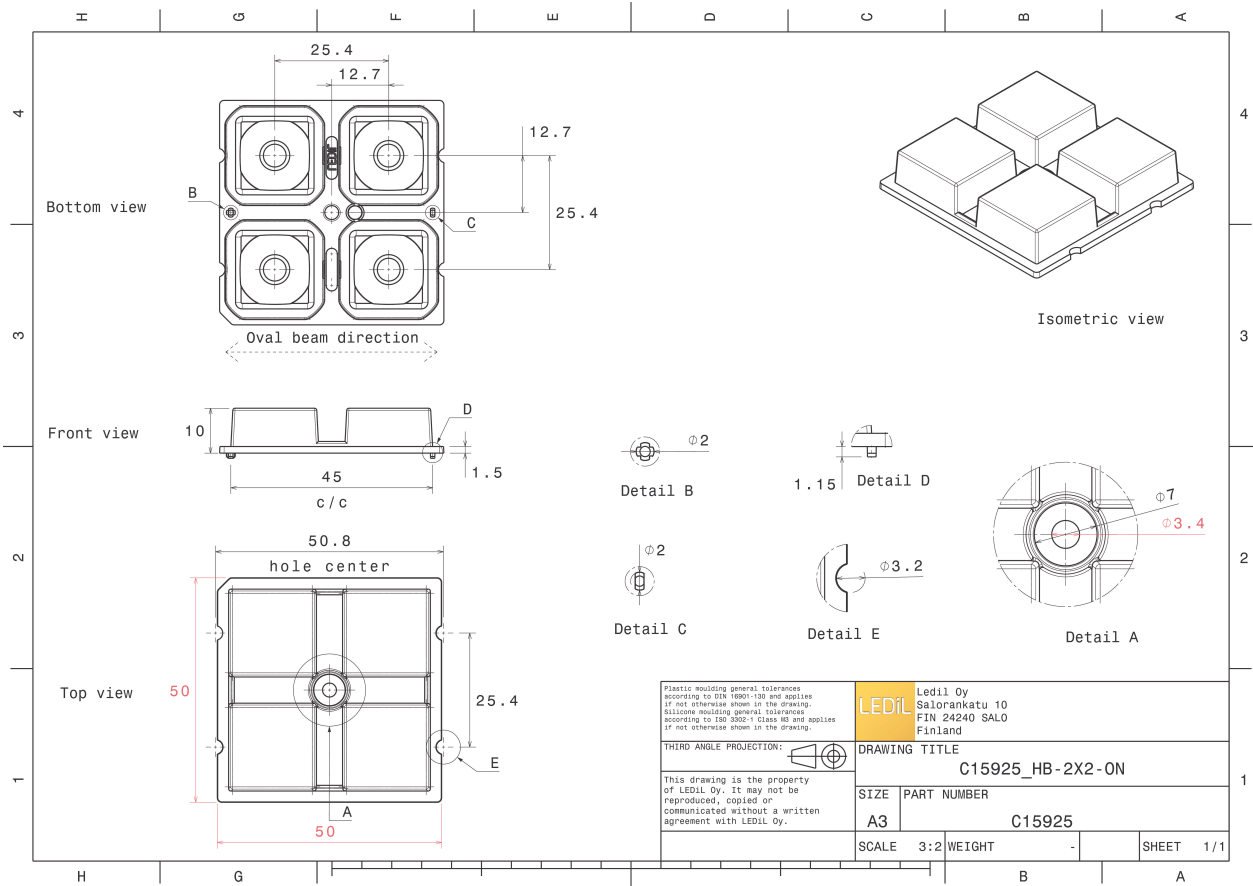



Component	Qty in box	MOQ	MPQ	Box weight (kg)
C15925_HB-2X2-ON » Box size: 480 x 280 x 300 mm	800	160	160	9.8



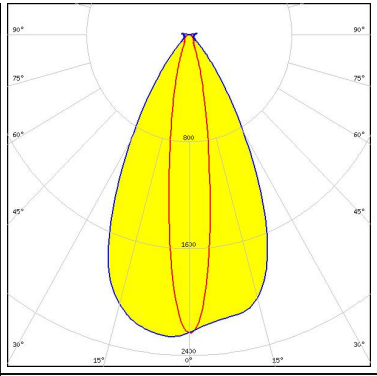

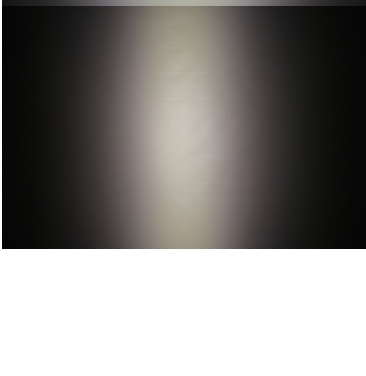
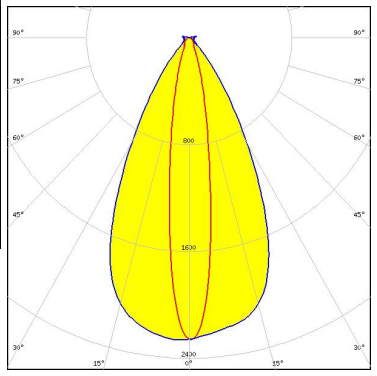
See also our general installation guide: www.ledil.com/installation_guide

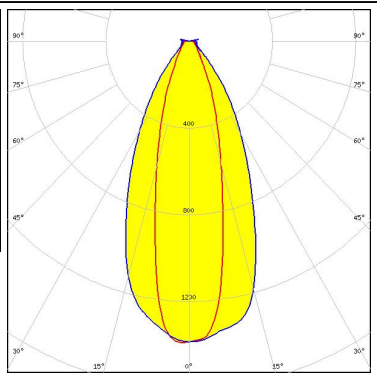
PHOTOMETRIC DATA (MEASURED):

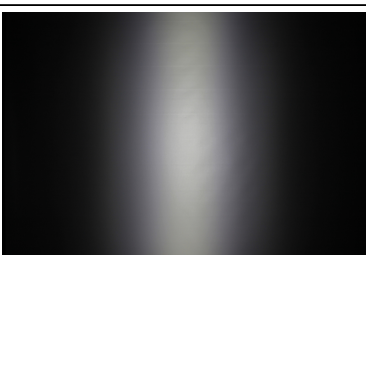
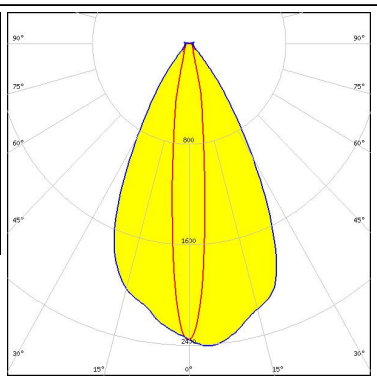
<p></p> <p>LED QUICK FLUX XTP 2x4 xxx LS G5</p> <p>FWHM / FWTM 16.0 + 55.0° / 40.0 + 83.0°</p> <p>Efficiency 93 %</p> <p>Peak intensity 2.3 cd/m</p> <p>LEDs/each optic 1</p> <p>Light colour White</p> <p>Required components:</p>		
<p></p> <p>LED QUICK FLUX XTP 2x6 xxx LS G5</p> <p>FWHM / FWTM 16.0 + 55.0° / 40.0 + 83.0°</p> <p>Efficiency 93 %</p> <p>Peak intensity 2.3 cd/m</p> <p>LEDs/each optic 1</p> <p>Light colour White</p> <p>Required components:</p>		
<p></p> <p>LED XD16</p> <p>FWHM / FWTM 27.0 + 49.0° / 62.0 + 89.0°</p> <p>Efficiency 90 %</p> <p>Peak intensity 1.4 cd/m</p> <p>LEDs/each optic 4</p> <p>Light colour White</p> <p>Required components:</p>		
<p></p> <p>LED XD16</p> <p>FWHM / FWTM 13.0 + 55.0° / 34.0 + 82.0°</p> <p>Efficiency 89 %</p> <p>Peak intensity 2.4 cd/m</p> <p>LEDs/each optic 1</p> <p>Light colour White</p> <p>Required components:</p>		

PHOTOMETRIC DATA (MEASURED):

CREE LED

LED XP-G2
 FWHM / FWTM 14.0 + 55.0° / 34.0 + 82.0°
 Efficiency 89 %
 Peak intensity 2.7 cd/lm
 LEDs/each optic 1
 Light colour White
 Required components:

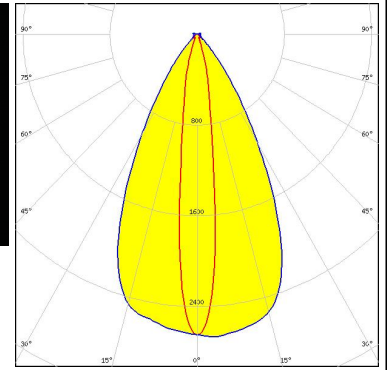
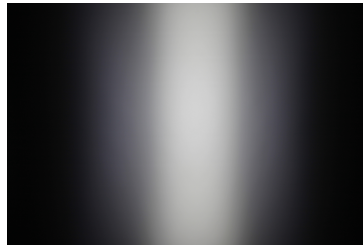

CREE LED

LED XP-L HI
 FWHM / FWTM 14.0 + 55.0° / 36.0 + 82.0°
 Efficiency 91 %
 Peak intensity 2.6 cd/lm
 LEDs/each optic 1
 Light colour White
 Required components:

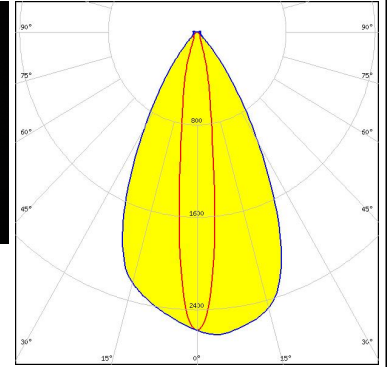

LUMILEDS

LED LUXEON V
 FWHM / FWTM 22.0 + 51.0° / 52.0 + 86.0°
 Efficiency 92 %
 Peak intensity 1.8 cd/lm
 LEDs/each optic 1
 Light colour White
 Required components:

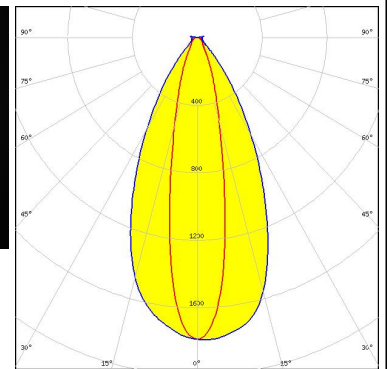
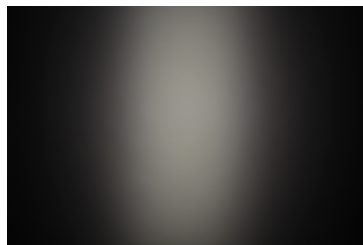

MST Your solutions

LED RecLED 122x50mm 1900lm 730 2x4 Opt G1
 FWHM / FWTM 15.0 + 54.0° / 38.5 + 82.5°
 Efficiency 94 %
 Peak intensity 2.4 cd/lm
 LEDs/each optic 1
 Light colour White
 Required components:

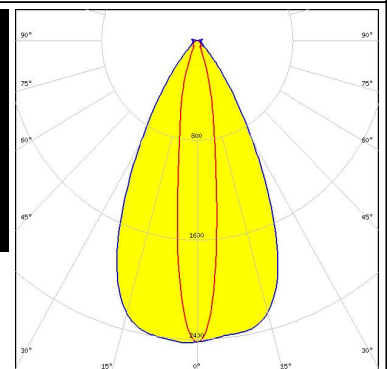
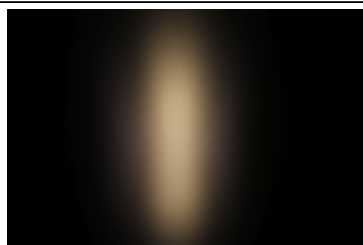

PHOTOMETRIC DATA (MEASURED):



LED NVSW219F
 FWHM / FWTM 17.0 + 53.0° / 40.0 + 83.0°
 Efficiency 93 %
 Peak intensity 2.4 cd/lm
 LEDs/each optic 1
 Light colour White
 Required components:

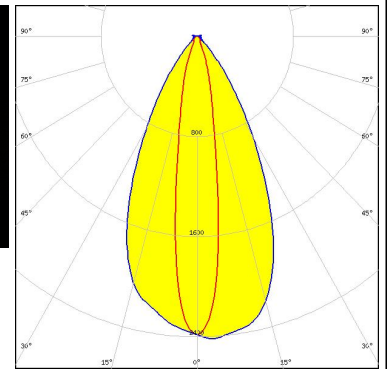
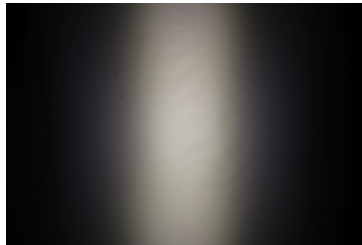

LED NVSW319B
 FWHM / FWTM 18.0 + 52.0° / 41.0 + 84.0°
 Efficiency 93 %
 Peak intensity 2.3 cd/lm
 LEDs/each optic 1
 Light colour White
 Required components:

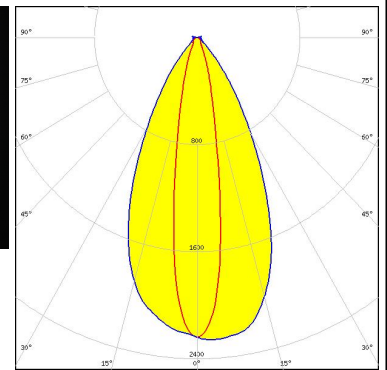
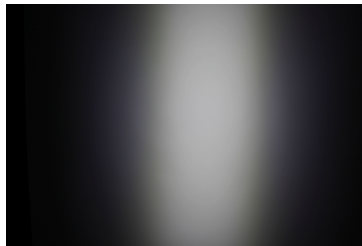

LED PL-BRICK HP 3800 2x8 SSG
 FWHM / FWTM 17.0 + 54.0° / 41.0 + 84.0°
 Efficiency 92 %
 Peak intensity 2.3 cd/lm
 LEDs/each optic 1
 Light colour White
 Required components:

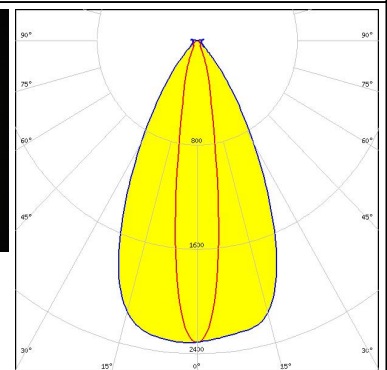
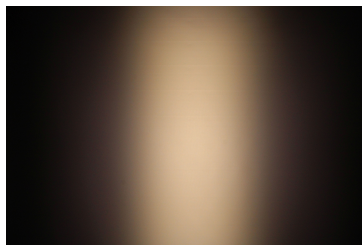

LED PrevaLED Brick HP 2x8
 FWHM / FWTM 15.0 + 54.0° / 36.0 + 82.0°
 Efficiency 91 %
 Peak intensity 2.6 cd/lm
 LEDs/each optic 1
 Light colour White
 Required components:

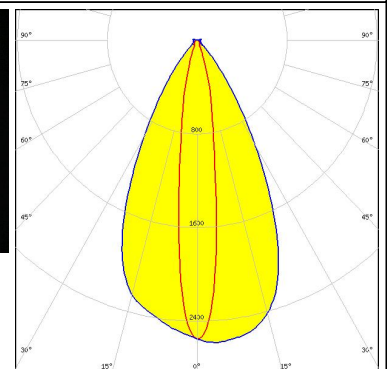
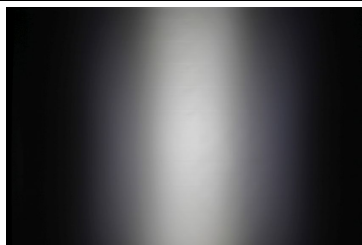

PHOTOMETRIC DATA (MEASURED):

OSRAM

Opto Semiconductors

LED Duris S8
 FWHM / FWTM 31.0 + 49.0° / 78.0 + 91.0°
 Efficiency 92 %
 Peak intensity 1.3 cd/lm
 LEDs/each optic 1
 Light colour White
 Required components:

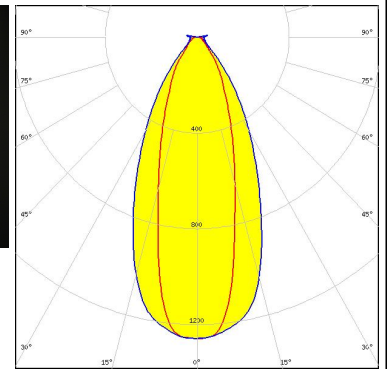

OSRAM

Opto Semiconductors

LED OSLOM Square CSSRM2/CSSRM3
 FWHM / FWTM 15.0 + 54.0° / 36.0 + 82.0°
 Efficiency 91 %
 Peak intensity 2.6 cd/lm
 LEDs/each optic 1
 Light colour White
 Required components:

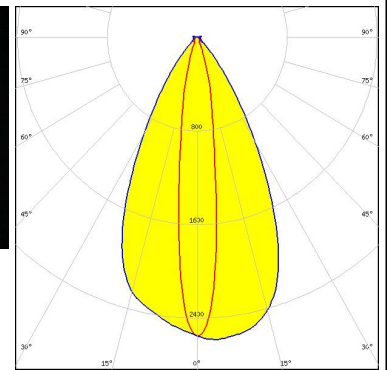
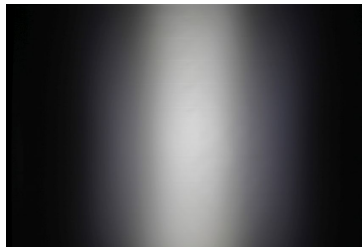

PHILIPS

LED Fortimo FastFlex LED 2x8 DA G4+
 FWHM / FWTM 18.0 + 53.0° / 41.0 + 84.0°
 Efficiency 94 %
 Peak intensity 2.2 cd/lm
 LEDs/each optic 1
 Light colour White
 Required components:

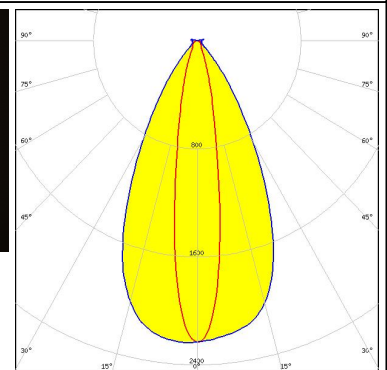
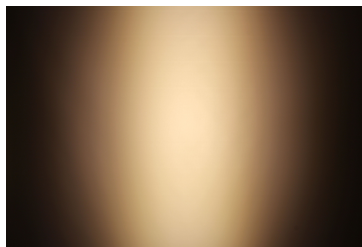

SAMSUNG

LED HiLOM RH16 (LH351C)
 FWHM / FWTM 17.0 + 54.0° / 42.0 + 84.0°
 Efficiency 94 %
 Peak intensity 2.3 cd/lm
 LEDs/each optic 1
 Light colour White
 Required components:

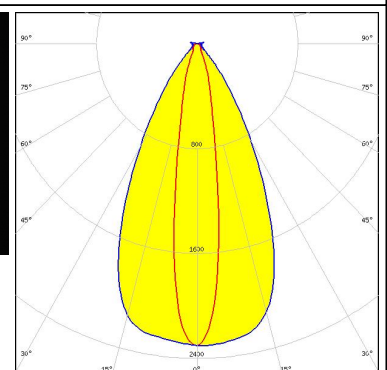
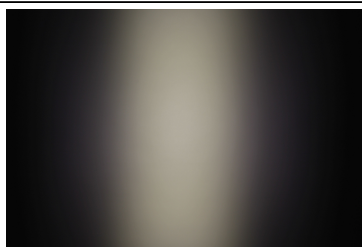

PHOTOMETRIC DATA (MEASURED):

			
LED	Z5M3		
FWHM / FWTM	18.0 + 53.0° / 44.0 + 84.0°		
Efficiency	93 %		
Peak intensity	2.1 cd/lm		
LEDs/each optic	1		
Light colour	White		
Required components:			

			
LED	Z8Y22		
FWHM / FWTM	20.0 + 53.0° / 50.0 + 85.0°		
Efficiency	91 %		
Peak intensity	1.6 cd/lm		
LEDs/each optic	1		
Light colour	White		
Required components:			

TRIDONIC

LED	RLE 2x4 2000lm HP EXC2 OTD	
FWHM / FWTM	15.0 + 55.0° / 37.0 + 82.0°	
Efficiency	94 %	
Peak intensity	2.5 cd/lm	
LEDs/each optic	1	
Light colour	White	
Required components:		

TRIDONIC

LED	RLE 2x8 4000lm HP EXC2 OTD		
FWHM / FWTM	15.0 + 55.0° / 37.0 + 82.0°		
Efficiency	94 %		
Peak intensity	2.5 cd/lm		
LEDs/each optic	1		
Light colour	White		
Required components:			

PHOTOMETRIC DATA (SIMULATED):



LED XHP35 HI
 FWHM / FWTM 16.0 + 50.0°
 Efficiency 90 %
 LEDs/each optic 1
 Light colour White
 Required components:

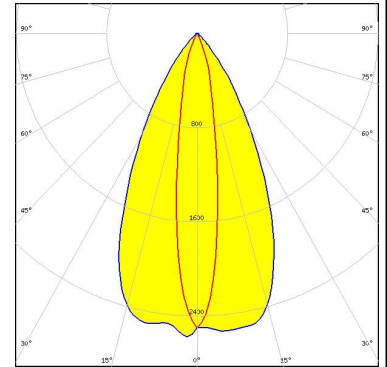

LED XP-E2
 FWHM / FWTM 54.0 + 10.0° / 78.0 + 27.0°
 Efficiency 93 %
 Peak intensity 3.8 cd/lm
 LEDs/each optic 1
 Light colour White
 Required components:

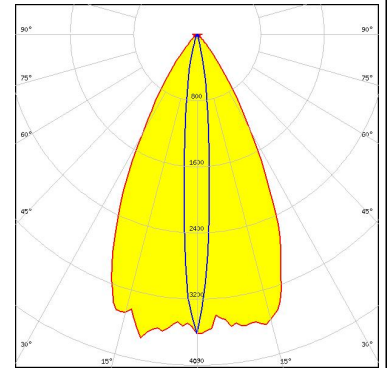

LED XP-E2
 FWHM / FWTM 10.0 + 50.0°
 Efficiency 90 %
 LEDs/each optic 1
 Light colour White
 Required components:



LED XP-G2 HE
 FWHM / FWTM 18.0 + 51.0° / 42.0 + 82.0°
 Efficiency 90 %
 Peak intensity 2.4 cd/lm
 LEDs/each optic 1
 Light colour White
 Required components:

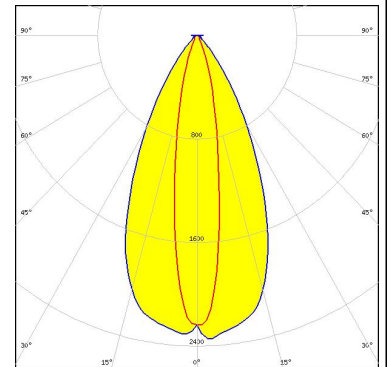

PHOTOMETRIC DATA (SIMULATED):

<p>CREE → LED</p> <p>LED: XP-G3 FWHM / FWTM: 17.0 + 48.0° Efficiency: 89 % LEDs/each optic: 1 Light colour: White Required components:</p>	
<p>CREE → LED</p> <p>LED: XP-L HD FWHM / FWTM: 18.0 + 50.0° Efficiency: 88 % LEDs/each optic: 1 Light colour: White Required components:</p>	
<p>CREE → LED</p> <p>LED: XT-E FWHM / FWTM: 14.0 + 55.0° / 34.0 + 80.0° Efficiency: 91 % Peak intensity: 2.9 cd/lm LEDs/each optic: 1 Light colour: White Required components:</p>	
<p>LUMILEDS</p> <p>LED: LUXEON 5050 Round LES FWHM / FWTM: 23.0 + 51.0° / 56.0 + 86.0° Efficiency: 89 % Peak intensity: 1.7 cd/lm LEDs/each optic: 1 Light colour: White Required components:</p>	

PHOTOMETRIC DATA (SIMULATED):

<p>LUMILEDS</p> <p>LED: LUXEON C</p> <p>FWHM / FWTM: 12.0 + 54.0° / 27.0 + 79.0°</p> <p>Efficiency: 91 %</p> <p>Peak intensity: 3.4 cd/lm</p> <p>LEDs/each optic: 1</p> <p>Light colour: White</p> <p>Required components:</p>	
<p>LUMILEDS</p> <p>LED: LUXEON TX</p> <p>FWHM / FWTM: 14.0 + 50.0°</p> <p>Efficiency: 90 %</p> <p>LEDs/each optic: 1</p> <p>Light colour: White</p> <p>Required components:</p>	
<p>NICHIA</p> <p>LED: NV4WB35AM</p> <p>FWHM / FWTM: 20.0 + 50.0° / 48.0 + 84.0°</p> <p>Efficiency: 90 %</p> <p>Peak intensity: 2.1 cd/lm</p> <p>LEDs/each optic: 1</p> <p>Light colour: White</p> <p>Required components:</p>	
<p>NICHIA</p> <p>LED: NVSxx19B/NVSxx19C</p> <p>FWHM / FWTM: 16.0 + 53.0° / 38.0 + 81.0°</p> <p>Efficiency: 90 %</p> <p>Peak intensity: 2.5 cd/lm</p> <p>LEDs/each optic: 1</p> <p>Light colour: White</p> <p>Required components:</p>	

PHOTOMETRIC DATA (SIMULATED):

OSRAM

Opto Semiconductors

LED Duris S8
 FWHM / FWTM 29.0 + 49.0° / 69.0 + 89.0°
 Efficiency 84 %
 Peak intensity 1.4 cd/lm
 LEDs/each optic 1
 Light colour White
 Required components:

Protective plate, glass

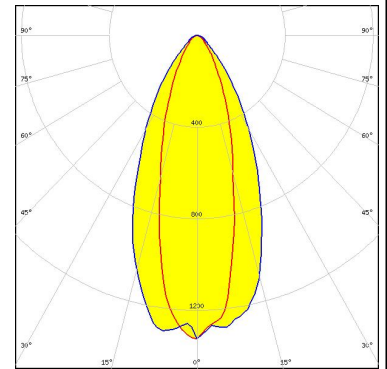

OSRAM

Opto Semiconductors

LED OSCONIQ C 2424
 FWHM / FWTM 12.0 + 54.0° / 30.0 + 78.0°
 Efficiency 92 %
 Peak intensity 3.3 cd/lm
 LEDs/each optic 1
 Light colour White
 Required components:

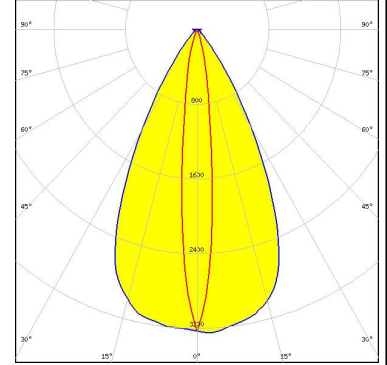

OSRAM

Opto Semiconductors

LED OSCONIQ P 3030
 FWHM / FWTM 10.0 + 56.0° / 28.0 + 78.0°
 Efficiency 94 %
 Peak intensity 3.5 cd/lm
 LEDs/each optic 1
 Light colour White
 Required components:

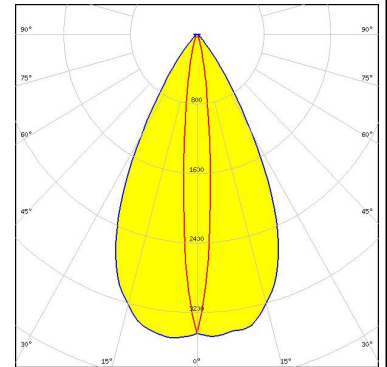

OSRAM

Opto Semiconductors

LED OSCONIQ P 3737 (2W version)
 FWHM / FWTM 13.0 + 56.0° / 34.0 + 81.0°
 Efficiency 93 %
 Peak intensity 2.9 cd/lm
 LEDs/each optic 1
 Light colour White
 Required components:

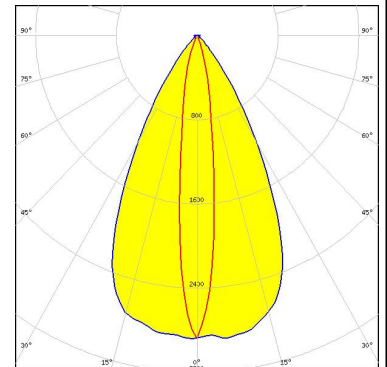

PHOTOMETRIC DATA (SIMULATED):

OSRAM

Opto Semiconductors

LED OSCONIQ P 3737 Flat
 FWHM / FWTM 16.0 + 54.0° / 38.0 + 80.0°
 Efficiency 92 %
 Peak intensity 2.6 cd/lm
 LEDs/each optic 1
 Light colour White
 Required components:

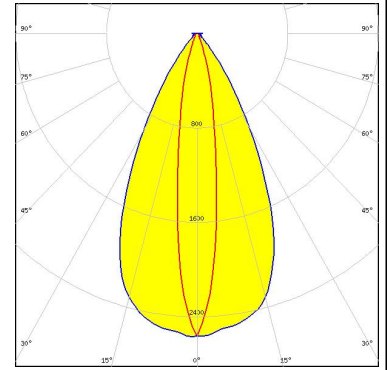

OSRAM

Opto Semiconductors

LED OSLON Square Flat
 FWHM / FWTM 12.0 + 52.0° / 29.0 + 76.0°
 Efficiency 93 %
 Peak intensity 3.5 cd/lm
 LEDs/each optic 1
 Light colour White
 Required components:

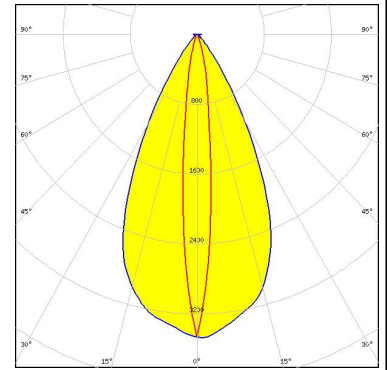

OSRAM

Opto Semiconductors

LED OSTAR Projection Compact (Kx.CSLNM1.xx)
 FWHM / FWTM 10.0 + 52.0° / 26.0 + 76.0°
 Efficiency 93 %
 Peak intensity 3.7 cd/lm
 LEDs/each optic 1
 Light colour White
 Required components:

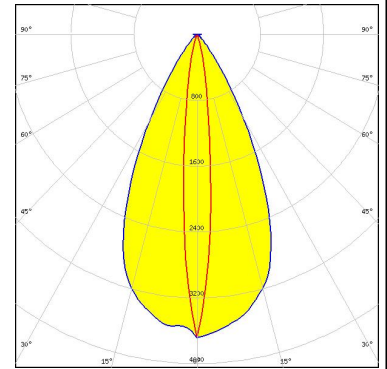

SAMSUNG

LED LH502C
 FWHM / FWTM 28.0 + 50.0° / 64.0 + 86.0°
 Efficiency 79 %
 Peak intensity 1.4 cd/lm
 LEDs/each optic 1
 Light colour White
 Required components:

Protective plate, glass

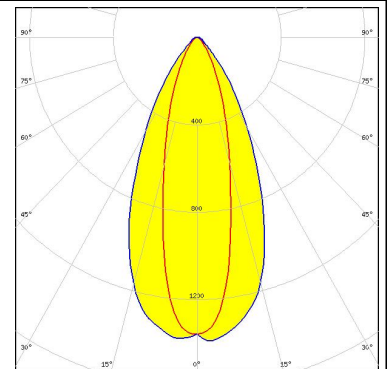

PHOTOMETRIC DATA (SIMULATED):

SAMSUNG

LED LH502C
 FWHM / FWTM 26.0 + 50.0° / 64.0 + 86.0°
 Efficiency 87 %
 Peak intensity 1.5 cd/lm
 LEDs/each optic 1
 Light colour White
 Required components:

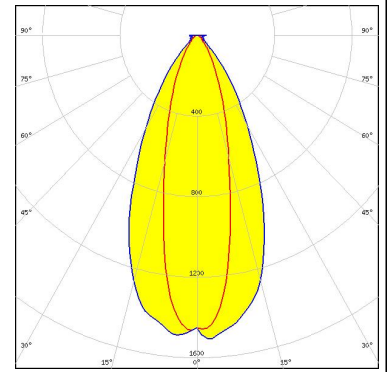

SEOUL SEMICONDUCTOR

LED MJT 5050
 FWHM / FWTM 28.0 + 50.0° / 67.0 + 88.0°
 Efficiency 87 %
 Peak intensity 1.5 cd/lm
 LEDs/each optic 1
 Light colour White
 Required components:

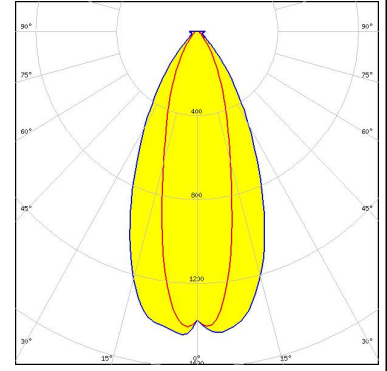

SEOUL SEMICONDUCTOR

LED SEOUL DC 5050 6V
 FWHM / FWTM 26.0 + 50.0° / 60.0 + 86.0°
 Efficiency 90 %
 Peak intensity 1.6 cd/lm
 LEDs/each optic 1
 Light colour White
 Required components:

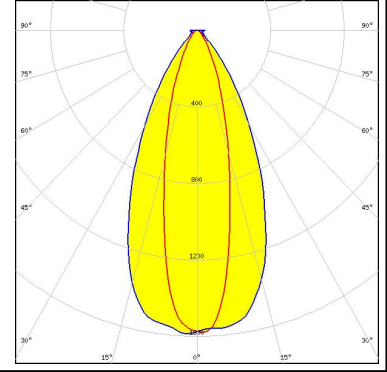

SEOUL SEMICONDUCTOR

LED Z8Y22T
 FWHM / FWTM 16.0 + 52.0° / 39.0 + 81.0°
 Efficiency 90 %
 Peak intensity 2.5 cd/lm
 LEDs/each optic 1
 Light colour White
 Required components:

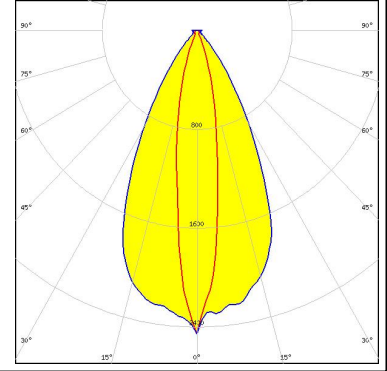

GENERAL INFORMATION:

NOTE: The typical beam angle will be changed by different color, chip size and chip position tolerance. The typical total beam angle is the full angle measured where the luminous intensity is half of the peak value.

MATERIALS:

As part of our continuous research and improvement processes, and to ensure the best possible quality and availability of our products, LEDiL reserves the right to change material grades without notice.

PRODUCT DATA USER AGREEMENT AND DISCLAIMER:

The measured data in the provided downloadable LEDiL Product Datasheets and Mechanical 2D-Drawings is rounded and provided as reference for planning. LEDiL Oy's optical specifications have been verified by conducting performance testing of the products in accordance with the company's quality system. The reported data are averaged results of multiple measurements with typical variation. LEDiL Oy reserves the right to without prior notification make changes and improvements to its products.

LEDiL Oy assumes neither warranty, nor guarantee nor any other liability of any kind for the contents and correctness of the provided data. The provided data has been generated with highest diligence but the provided data may in reality not represent the complete possible variation range of all intrinsic parameters. Therefore, in certain cases a deviation from the provided data could occur.

LEDiL Oy reserves the right to undertake technical changes of its products without further notification which could lead to changes in the provided data. LEDiL Oy assumes no liability of any kind for the possible deviation from any provided data or any other damage resulting from the usage of the provided data.

The user agrees to this disclaimer and user agreement with the download or usage of the provided files.

LEDiL Oy

Joensuunkatu 13
FI-24240 SALO
Finland

LEDiL Inc.

228 West Page Street
Suite D
Sycamore IL 60178
USA

Ledil Optics Technology (Shenzhen) Co., Ltd.

405 , Block B
Casic Motor Building
Shenzhen 518057
P.R.CHINA

Local sales and technical support

[www.ledil.com/
where_to_buy](http://www.ledil.com/where_to_buy)

Shipping locations

Salo, Finland
Hong Kong, China

Distribution Partners

[www.ledil.com/
where_to_buy](http://www.ledil.com/where_to_buy)