

## LENINA-W

~55° wide beam

### TECHNICAL SPECIFICATIONS:

Dimensions	Ø 74.0 mm
Height	40 mm
Fastening	socket
ROHS compliant	yes ⓘ

### MATERIAL SPECIFICATIONS:

Component	Type	Material
LENINA-W	Reflector	PC

### ORDERING INFORMATION:

Component
C12599_LENINA-W
» Box size: 476 x 273 x 197 mm







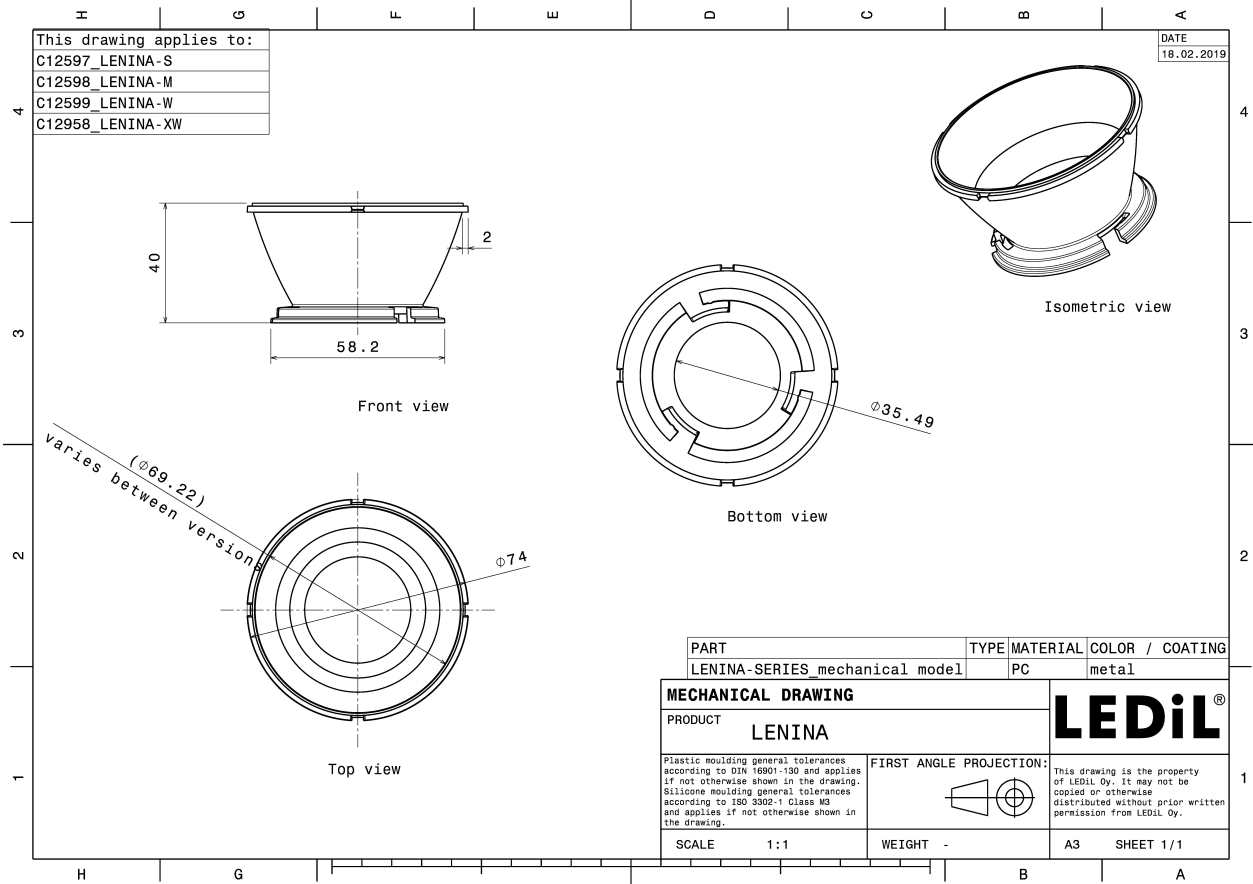

Colour	Finish	Coating
metal		lacquer

Qty in box	MOQ	MPQ	Box weight (kg)
60	120	60	2.0

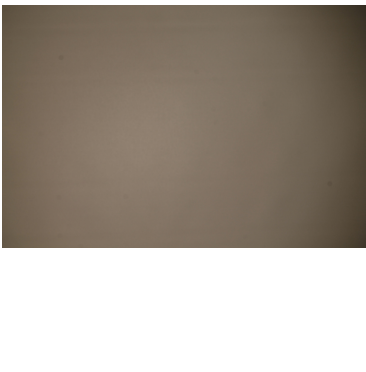
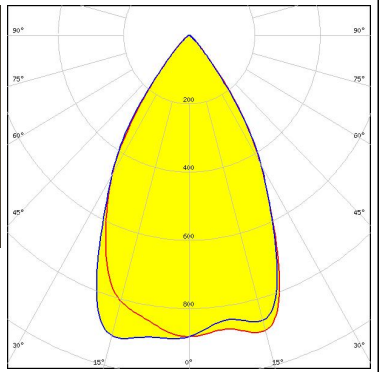

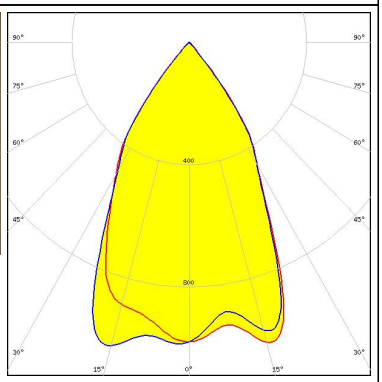

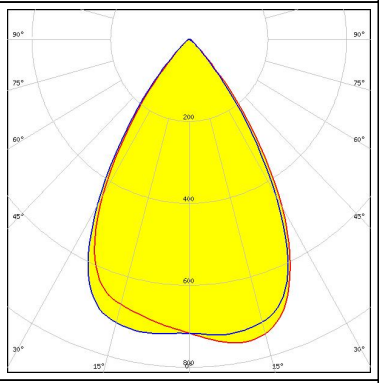

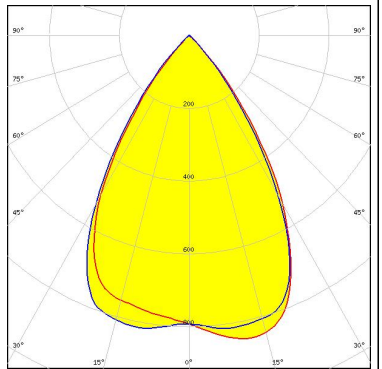



See also our general installation guide: [www.ledil.com/installation\\_guide](http://www.ledil.com/installation_guide)



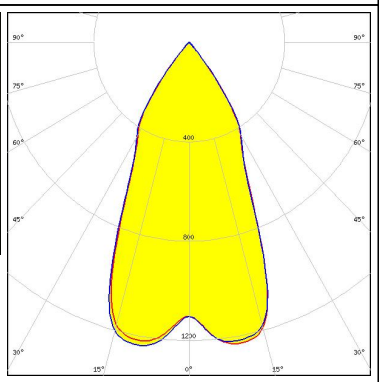

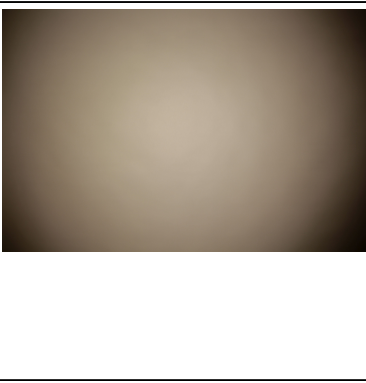
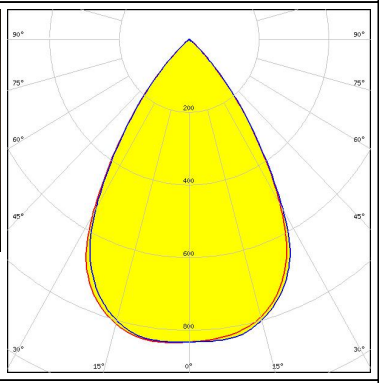

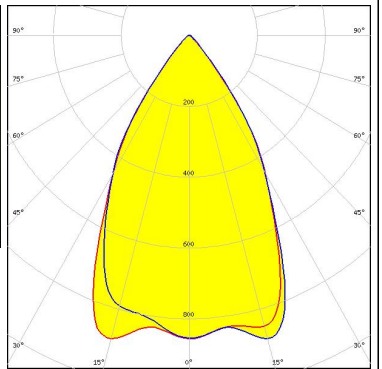
### PHOTOMETRIC DATA (MEASURED):

<p></p> <p>LED BXRA ES Rectangle            FWHM / FWTM 60.0° / 84.0°            Efficiency 86 %            Peak intensity 0.9 cd/lm            LEDs/each optic 1            Light colour White</p> <p>Required components:            C12153_LENINA-STD-BASE-BXRA            C12606_LENINA-DL</p>		
<p></p> <p>LED BXRA ES Rectangle            FWHM / FWTM 58.0° / 82.0°            Efficiency 91 %            Peak intensity 1.1 cd/lm            LEDs/each optic 1            Light colour White</p> <p>Required components:            C12153_LENINA-STD-BASE-BXRA</p>		
<p></p> <p>LED BXRA RS            FWHM / FWTM 60.0° / 89.0°            Efficiency 80 %            Peak intensity 0.8 cd/lm            LEDs/each optic 1            Light colour White</p> <p>Required components:            C12229_LENINA-STD-BASE-RS            C12606_LENINA-DL</p>		
<p></p> <p>LED BXRA RS            FWHM / FWTM 64.0° / 87.0°            Efficiency 88 %            Peak intensity 0.9 cd/lm            LEDs/each optic 1            Light colour White</p> <p>Required components:            C12229_LENINA-STD-BASE-RS</p>		

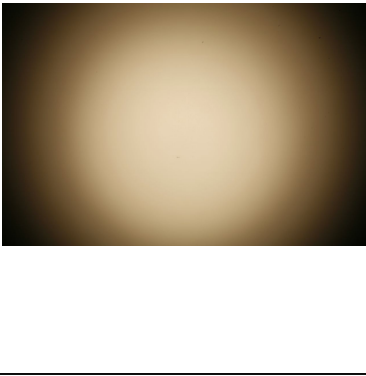
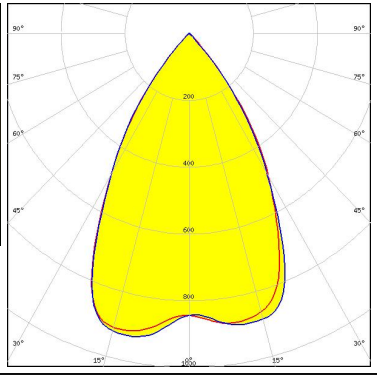
#### PHOTOMETRIC DATA (MEASURED):

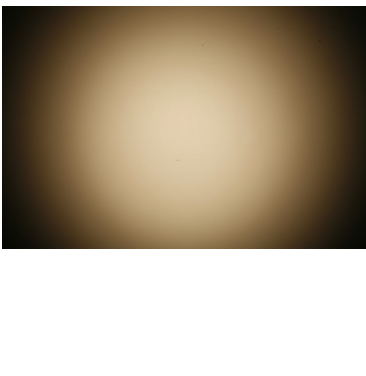
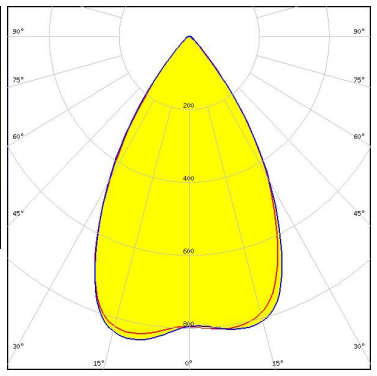
<p></p> <p>LED V10 Gen6</p> <p>FWHM / FWTM 47.0° / 80.0°</p> <p>Efficiency 83 %</p> <p>Peak intensity 1.3 cd/m</p> <p>LEDs/each optic 1</p> <p>Light colour White</p> <p>Required components: C13186_LENINA-STD-BASE-CXA15 C12606_LENINA-DL</p>		
<p></p> <p>LED V4 HD</p> <p>FWHM / FWTM 48.0° / 79.0°</p> <p>Efficiency 91 %</p> <p>Peak intensity 1.2 cd/m</p> <p>LEDs/each optic 1</p> <p>Light colour White</p> <p>Required components: C14146_LENINA-STD-BASE-CXA18</p>		
<p></p> <p>LED Vero SE 29</p> <p>FWHM / FWTM 66.0° / 90.0°</p> <p>Efficiency 91 %</p> <p>Peak intensity 0.8 cd/m</p> <p>LEDs/each optic 1</p> <p>Light colour White</p> <p>Required components: C15083_LENINA-STD-BASE-VERO29</p>		
<p></p> <p>LED VERO13</p> <p>FWHM / FWTM 60.0° / 84.0°</p> <p>Efficiency 85 %</p> <p>Peak intensity 0.9 cd/m</p> <p>LEDs/each optic 1</p> <p>Light colour White</p> <p>Required components: C13868_LENINA-STD-BASE-VERO13-18 C12606_LENINA-DL</p>		

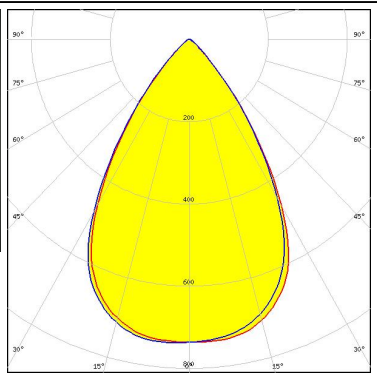
#### PHOTOMETRIC DATA (MEASURED):

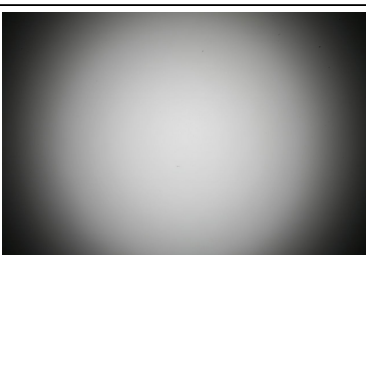
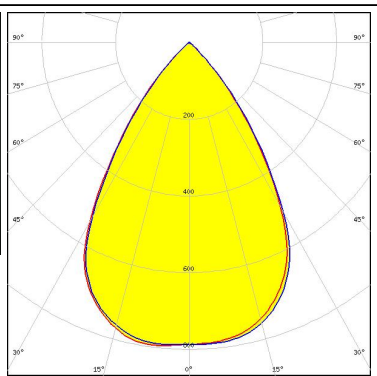
<p></p> <p>LED VERO18            FWHM / FWTM 64.0° / 85.0°            Efficiency 89 %            Peak intensity 0.9 cd/m            LEDs/each optic 1            Light colour White            Required components:            C13868_LENINA-STD-BASE-VERO13-18</p>		
<p></p> <p>LED VERO18            FWHM / FWTM 64.0° / 86.0°            Efficiency 85 %            Peak intensity 0.9 cd/m            LEDs/each optic 1            Light colour White            Required components:            C13868_LENINA-STD-BASE-VERO13-18            C12606_LENINA-DL</p>		
<p></p> <p>LED VERO29            FWHM / FWTM 67.0° / 92.0°            Efficiency 84 %            Peak intensity 0.7 cd/m            LEDs/each optic 1            Light colour White            Required components:            C13867_LENINA-STD-BASE-VERO29            C12606_LENINA-DL</p>		
<p></p> <p>LED VERO29            FWHM / FWTM 67.0° / 91.0°            Efficiency 88 %            Peak intensity 0.8 cd/m            LEDs/each optic 1            Light colour White            Required components:            C13867_LENINA-STD-BASE-VERO29</p>		

#### PHOTOMETRIC DATA (MEASURED):

### CITIZEN

LED CL-L340  
 FWHM / FWTM 50.0° / 83.0°  
 Efficiency 78 %  
 LEDs/each optic 1  
 Light colour White  
 Required components:  
 C11995\_LENINA-STD-BASE-CL340  
 C12606\_LENINA-DL

### CITIZEN

LED CL-L340  
 FWHM / FWTM 48.0° / 80.0°  
 Efficiency 86 %  
 LEDs/each optic 1  
 Light colour White  
 Required components:  
 C11995\_LENINA-STD-BASE-CL340

### CITIZEN

LED CL-L340  
 FWHM / FWTM 53.0° / 81.0°  
 Efficiency 91 %  
 Peak intensity 1.1 cd/lm  
 LEDs/each optic 1  
 Light colour White  
 Required components:  
 C11995\_LENINA-STD-BASE-CL340

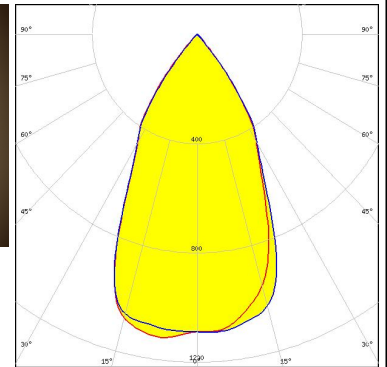
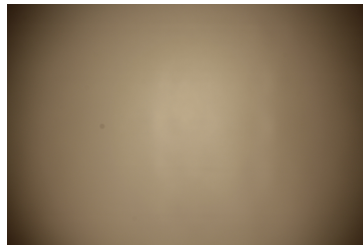

### CITIZEN

LED CLL02x/CLU02x (LES10)  
 FWHM / FWTM 57.0° / 82.0°  
 Efficiency 86 %  
 Peak intensity 1 cd/lm  
 LEDs/each optic 1  
 Light colour White  
 Required components:  
 C13868\_LENINA-STD-BASE-VERO13-18  
 C12606\_LENINA-DL  
 Bender Wirth: 434 Typ L1

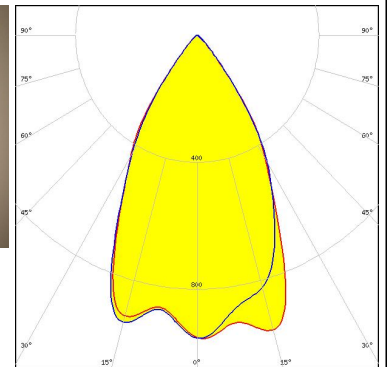
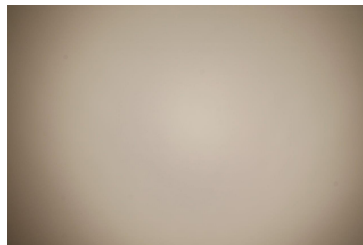

### PHOTOMETRIC DATA (MEASURED):

#### CITIZEN

LED CLL03x/CLU03x  
 FWHM / FWTM 58.0° / 84.0°  
 Efficiency 86 %  
 Peak intensity 1 cd/lm  
 LEDs/each optic 1  
 Light colour White  
 Required components:  
 C12691\_LENINA-STD-BASE-CLL030  
 C12606\_LENINA-DL

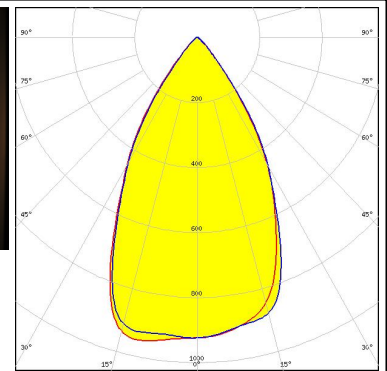
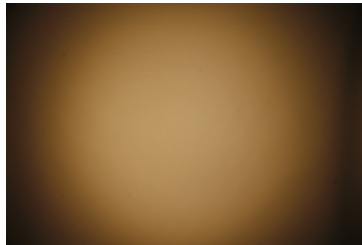

#### CITIZEN

LED CLL03x/CLU03x  
 FWHM / FWTM 60.0° / 83.0°  
 Efficiency 86 %  
 Peak intensity 1 cd/lm  
 LEDs/each optic 1  
 Light colour White  
 Required components:  
 C13868\_LENINA-STD-BASE-VERO13-18  
 C12606\_LENINA-DL  
 Bender Wirth: 433 Typ L1

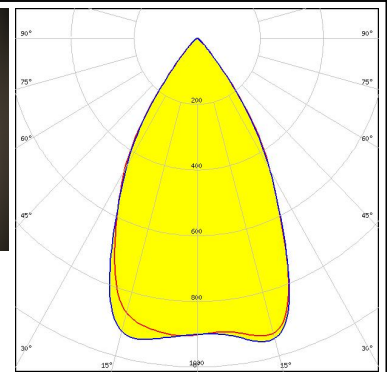
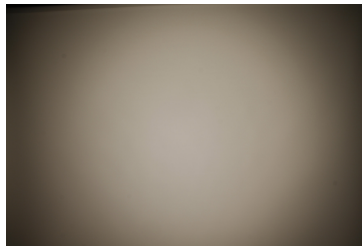

#### CITIZEN

LED CLL03x/CLU03x  
 FWHM / FWTM 56.0° / 82.0°  
 Efficiency 90 %  
 Peak intensity 1.1 cd/lm  
 LEDs/each optic 1  
 Light colour White  
 Required components:  
 C12691\_LENINA-STD-BASE-CLL030

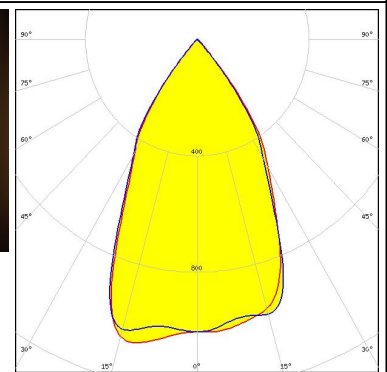
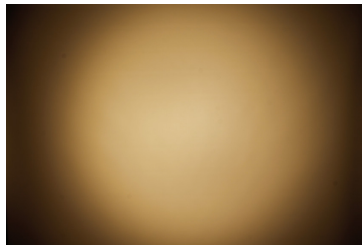

#### CITIZEN

LED CLL04x/CLU04x  
 FWHM / FWTM 61.0° / 87.0°  
 Efficiency 86 %  
 Peak intensity 0.9 cd/lm  
 LEDs/each optic 1  
 Light colour White  
 Required components:  
 C13867\_LENINA-STD-BASE-VERO29  
 C12606\_LENINA-DL  
 Bender Wirth: 431 Typ L3

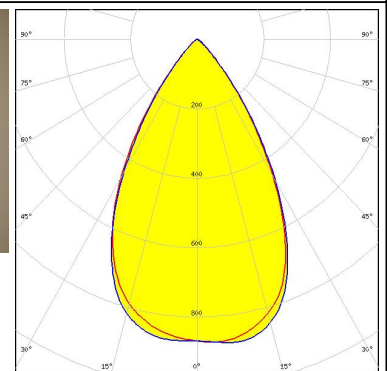
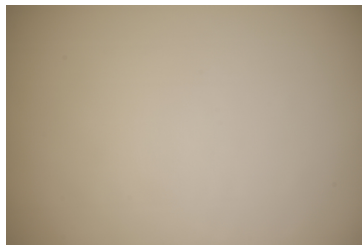

#### PHOTOMETRIC DATA (MEASURED):

#### CITIZEN

LED CLL04x/CLU04x  
 FWHM / FWTM 58.0° / 85.0°  
 Efficiency 78 %  
 Peak intensity 0.9 cd/lm  
 LEDs/each optic 1  
 Light colour White  
 Required components:  
 C12606\_LENINA-DL  
 A.A.G. STUCCHI: 8102-G2 + S-8000-12

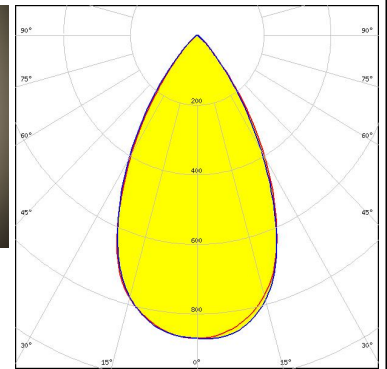
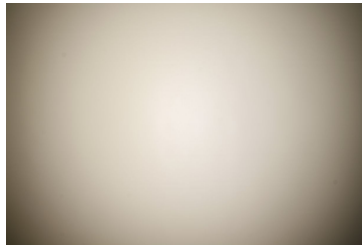

#### CITIZEN

LED CLL04x/CLU04x  
 FWHM / FWTM 55.0° / 84.0°  
 Efficiency 86 %  
 Peak intensity 1 cd/lm  
 LEDs/each optic 1  
 Light colour White  
 Required components:  
 C12606\_LENINA-DL  
 IDEAL: 50-2204CT + 50-2100LN

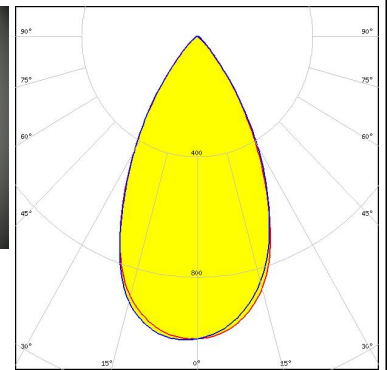

#### CITIZEN

LED CLL04x/CLU04x  
 FWHM / FWTM 61.0° / 85.0°  
 Efficiency 91 %  
 Peak intensity 1 cd/lm  
 LEDs/each optic 1  
 Light colour White  
 Required components:  
 C13867\_LENINA-STD-BASE-VERO29  
 Bender Wirth: 431 Typ L3

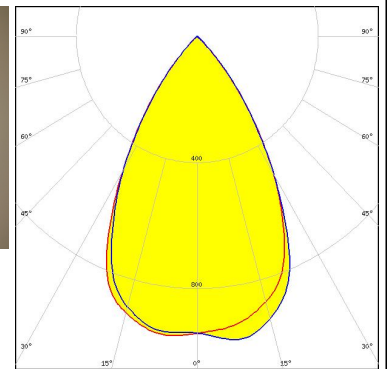
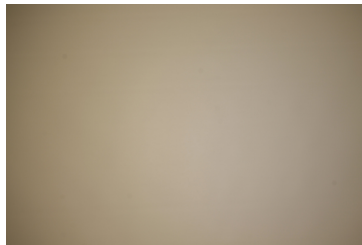

#### CITIZEN

LED CLL04x/CLU04x  
 FWHM / FWTM 56.0° / 87.0°  
 Efficiency 76 %  
 Peak intensity 0.9 cd/lm  
 LEDs/each optic 1  
 Light colour White  
 Required components:  
 C12692\_LENINA-STD-BASE-CLL040  
 C12606\_LENINA-DL

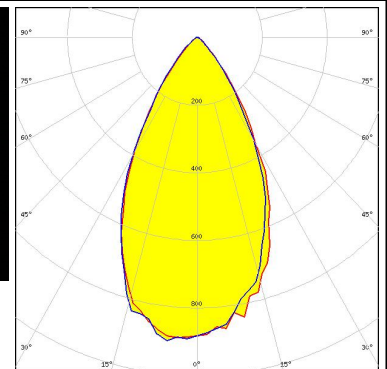
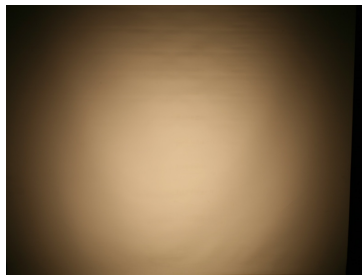



#### PHOTOMETRIC DATA (MEASURED):

#### CITIZEN

LED CLL04x/CLU04x  
 FWHM / FWTM 57.0° / 84.0°  
 Efficiency 82 %  
 Peak intensity 1 cd/lm  
 LEDs/each optic 1  
 Light colour White  
 Required components:  
 A.A.G. STUCCHI: 8102-G2 + S-8000-12

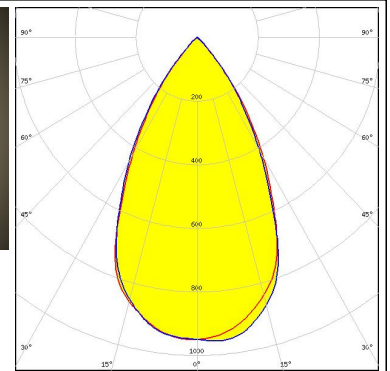
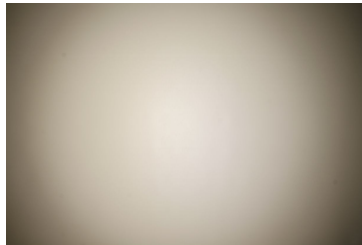

#### CITIZEN

LED CLL04x/CLU04x  
 FWHM / FWTM 54.0° / 83.0°  
 Efficiency 87 %  
 Peak intensity 1.1 cd/lm  
 LEDs/each optic 1  
 Light colour White  
 Required components:  
 IDEAL: 50-2204CT + 50-2100LN

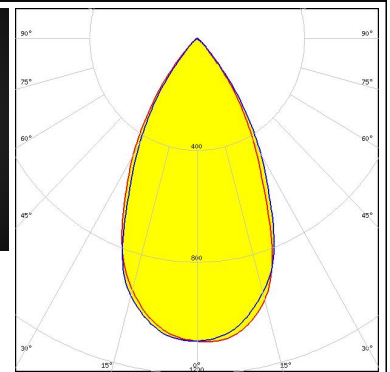
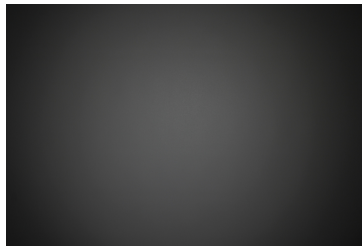

#### CITIZEN

LED CLL04x/CLU04x  
 FWHM / FWTM 59.0° / 85.0°  
 Efficiency 84 %  
 Peak intensity 1 cd/lm  
 LEDs/each optic 1  
 Light colour White  
 Required components:  
 C12692\_LENINA-STD-BASE-CLL040

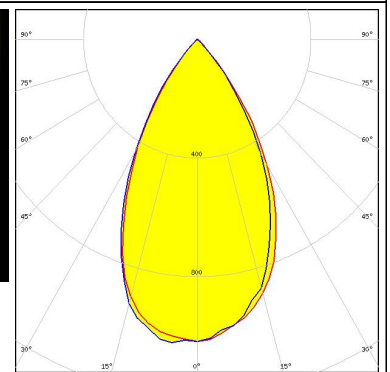
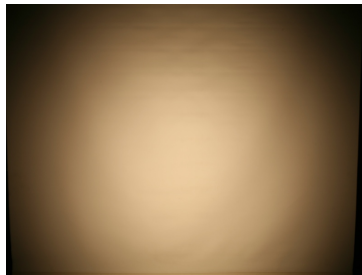

#### CITIZEN

LED CLU710/711  
 FWHM / FWTM 55.0° / 82.0°  
 Efficiency 89 %  
 Peak intensity 1 cd/lm  
 LEDs/each optic 1  
 Light colour White  
 Required components:  
 C12691\_LENINA-STD-BASE-CLL030  
 C12606\_LENINA-DL

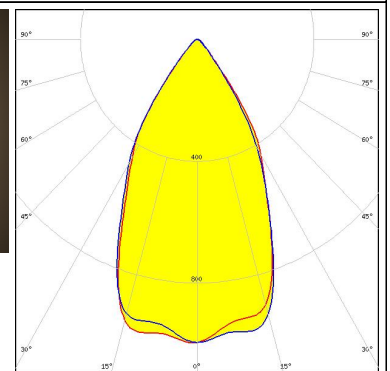
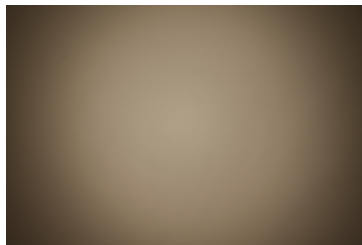

#### PHOTOMETRIC DATA (MEASURED):

#### CITIZEN

LED CLU720/721  
 FWHM / FWTM 57.0° / 83.0°  
 Efficiency 83 %  
 Peak intensity 0.9 cd/lm  
 LEDs/each optic 1  
 Light colour White  
 Required components:  
 C12691\_LENINA-STD-BASE-CLL030  
 C12606\_LENINA-DL

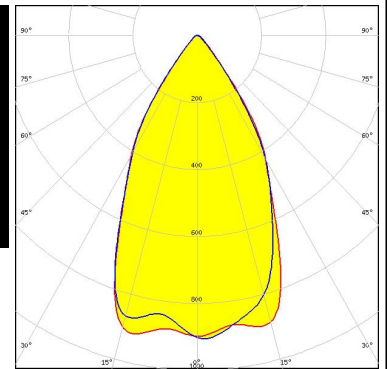
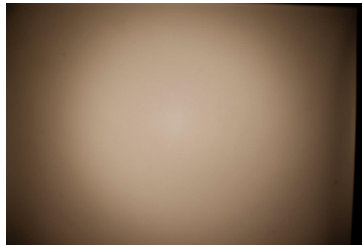

#### CITIZEN

LED CLU720/721  
 FWHM / FWTM 54.0° / 81.0°  
 Efficiency 87 %  
 Peak intensity 1 cd/lm  
 LEDs/each optic 1  
 Light colour White  
 Required components:  
 C12691\_LENINA-STD-BASE-CLL030

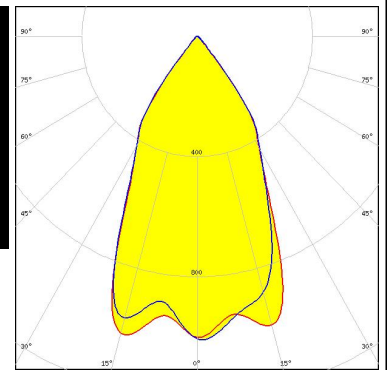
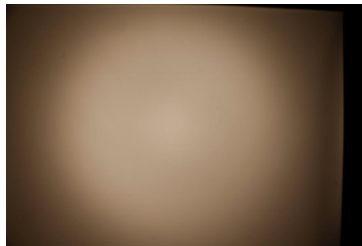

#### CITIZEN

LED CLU730/731  
 FWHM / FWTM 50.0° / 82.0°  
 Efficiency 83 %  
 Peak intensity 1 cd/lm  
 LEDs/each optic 1  
 Light colour White  
 Required components:  
 C12692\_LENINA-STD-BASE-CLL040  
 C12606\_LENINA-DL

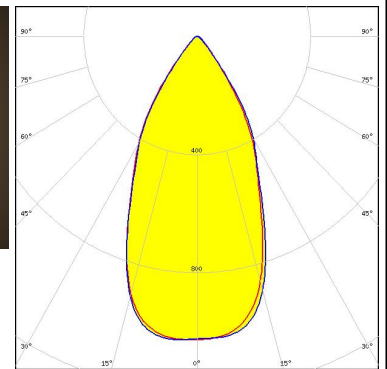
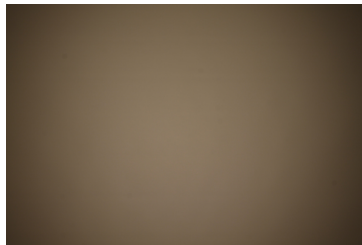





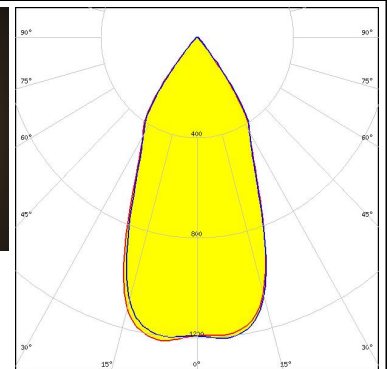
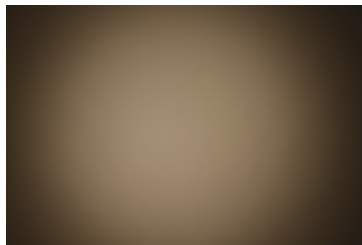

#### CITIZEN

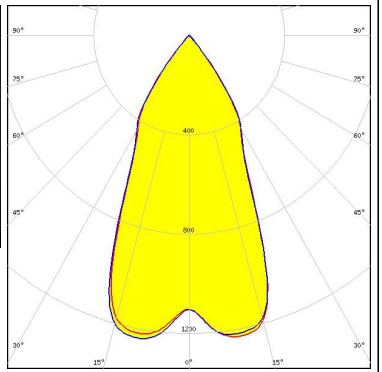
LED CLU730/731  
 FWHM / FWTM 49.0° / 80.0°  
 Efficiency 93 %  
 Peak intensity 1.2 cd/lm  
 LEDs/each optic 1  
 Light colour White  
 Required components:  
 C12692\_LENINA-STD-BASE-CLL040

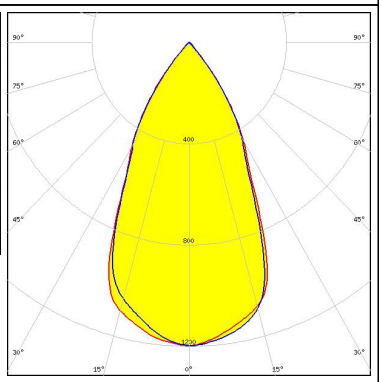

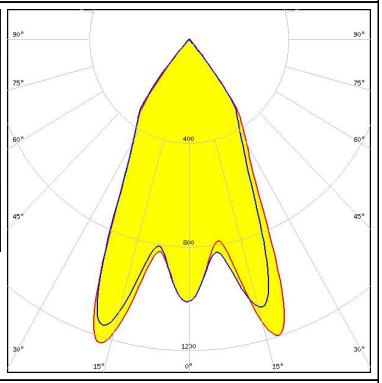
### PHOTOMETRIC DATA (MEASURED):

<p><b>CREE</b> → <b>LED</b></p> <p>LED CMA1840            FWHM / FWTM 48.0° / 79.0°            Efficiency 91 %            Peak intensity 1.2 cd/m            LEDs/each optic 1            Light colour White            Required components:            C14146_LENASTD-BASE-CXA18</p>		
<p><b>CREE</b> → <b>LED</b></p> <p>LED CMA2550            FWHM / FWTM 51.0° / 80.0°            Efficiency 91 %            Peak intensity 1.2 cd/m            LEDs/each optic 1            Light colour White            Required components:            C13324_LENASTD-BASE-CXA25</p>		
<p><b>CREE</b> → <b>LED</b></p> <p>LED CMT14xx            FWHM / FWTM 55.0° / 81.0°            Efficiency 91 %            Peak intensity 1.2 cd/m            LEDs/each optic 1            Light colour White            Required components:            C13868_LENASTD-BASE-VERO13-18            Bender Wirth: 434 Typ L1</p>		
<p><b>CREE</b> → <b>LED</b></p> <p>LED CMT19xx            FWHM / FWTM 54.0° / 81.0°            Efficiency 91 %            Peak intensity 1.1 cd/m            LEDs/each optic 1            Light colour White            Required components:            C12691_LENASTD-BASE-CLL030            Bender Wirth: 477 Typ L1</p>		

### PHOTOMETRIC DATA (MEASURED):

#### CREE LED

LED CMT19xx  
 FWHM / FWTM 55.0° / 82.0°  
 Efficiency 91 %  
 Peak intensity 1.1 cd/lm  
 LEDs/each optic 1  
 Light colour White  
 Required components:  
 C13868\_LENINA-STD-BASE-VERO13-18  
 Bender Wirth: 477 Typ L1

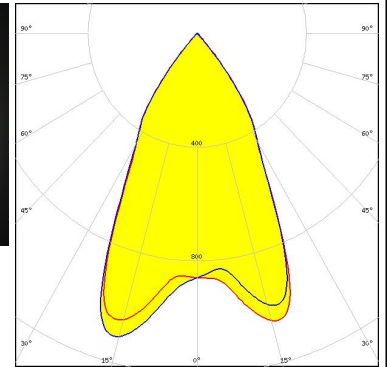
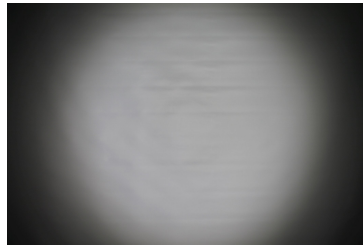

#### CREE LED

LED CMT28xx  
 FWHM / FWTM 60.0° / 84.0°  
 Efficiency 91 %  
 Peak intensity 1 cd/lm  
 LEDs/each optic 1  
 Light colour White  
 Required components:  
 C13867\_LENINA-STD-BASE-VERO29  
 Bender Wirth: 471 Typ L3

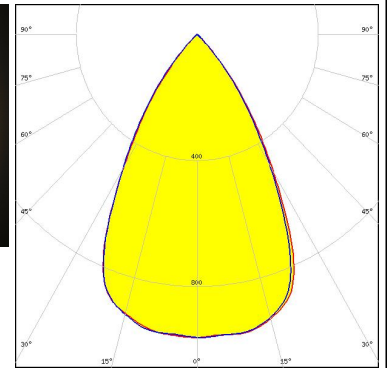
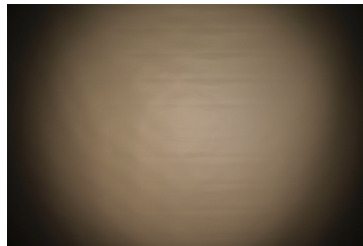

#### CREE LED

LED CMT28xx  
 FWHM / FWTM 56.0° / 82.0°  
 Efficiency 92 %  
 Peak intensity 1.1 cd/lm  
 LEDs/each optic 1  
 Light colour White  
 Required components:  
 C12692\_LENINA-STD-BASE-CLL040

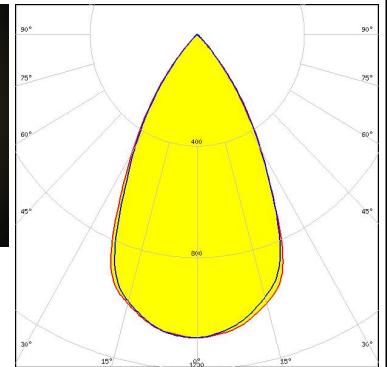
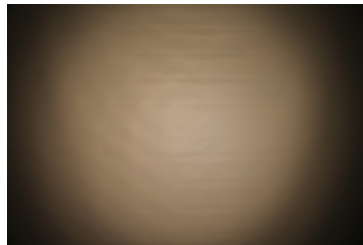





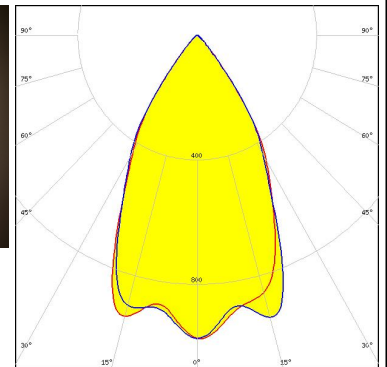
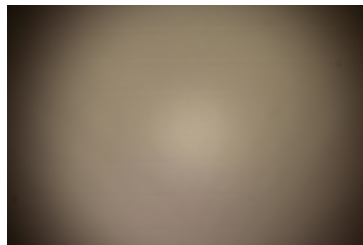

#### CREE LED

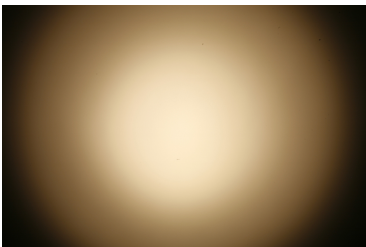
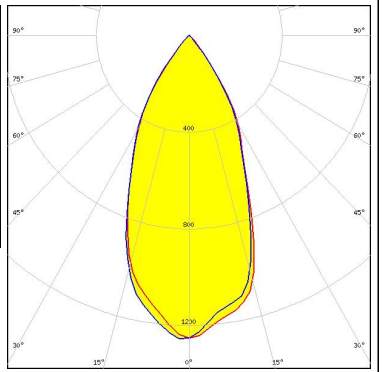
LED CXA/B 15xx  
 FWHM / FWTM 57.0° / 82.0°  
 Efficiency 86 %  
 Peak intensity 1 cd/lm  
 LEDs/each optic 1  
 Light colour White  
 Required components:  
 C13868\_LENINA-STD-BASE-VERO13-18  
 C12606\_LENINA-DL  
 Bender Wirth: 441 Typ L1

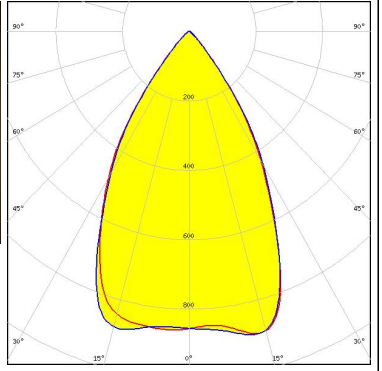

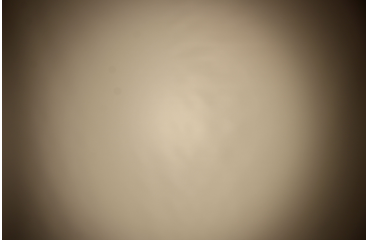
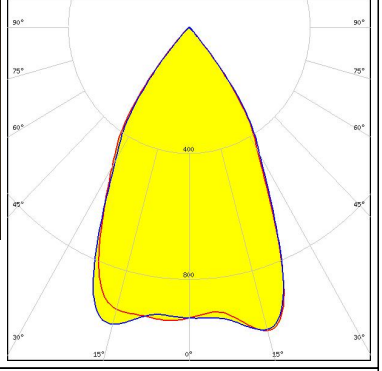
#### PHOTOMETRIC DATA (MEASURED):

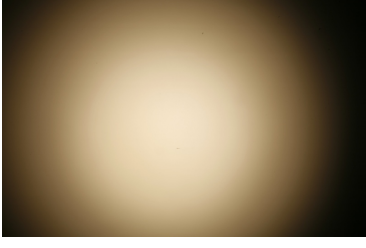
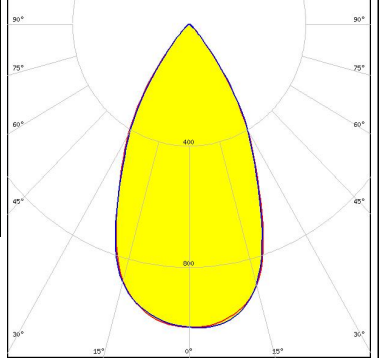
<p><b>CREE</b>  <b>LED</b></p> <p>LED CXA/B 15xx            FWHM / FWTM 48.0° / 79.0°            Efficiency 83 %            Peak intensity 1.3 cd/lm            LEDs/each optic 1            Light colour White</p> <p>Required components:            C13186_LENINA-STD-BASE-CXA15            C12606_LENINA-DL</p>		
<p><b>CREE</b>  <b>LED</b></p> <p>LED CXA/B 1830            FWHM / FWTM 61.0° / 85.0°            Efficiency 86 %            Peak intensity 0.9 cd/lm            LEDs/each optic 1            Light colour White</p> <p>Required components:            C13868_LENINA-STD-BASE-VERO13-18            C12606_LENINA-DL            Bender Wirth: 437 Typ L1</p>		
<p><b>CREE</b>  <b>LED</b></p> <p>LED CXA/B 1830            FWHM / FWTM 60.0° / 83.0°            Efficiency 91 %            Peak intensity 1 cd/lm            LEDs/each optic 1            Light colour White</p> <p>Required components:            C13868_LENINA-STD-BASE-VERO13-18            Bender Wirth: 437 Typ L1</p>		
<p><b>CREE</b>  <b>LED</b></p> <p>LED CXA/B 25xx            FWHM / FWTM 52.0° / 80.0°            Efficiency 76 %            Peak intensity 1.1 cd/lm            LEDs/each optic 1            Light colour White</p> <p>Required components:            C13324_LENINA-STD-BASE-CXA25            C12606_LENINA-DL</p>		

### PHOTOMETRIC DATA (MEASURED):

#### CREE LED

LED CXA/B 25xx  
 FWHM / FWTM 51.0° / 80.0°  
 Efficiency 84 %  
 Peak intensity 1.2 cd/lm  
 LEDs/each optic 1  
 Light colour White  
 Required components:  
 C13324\_LENINA-STD-BASE-CXA25

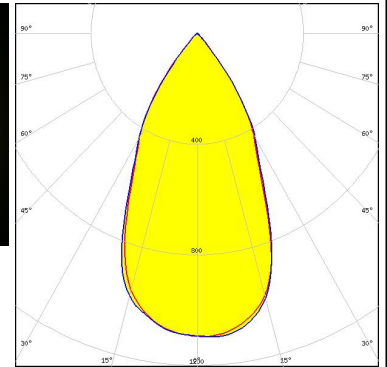
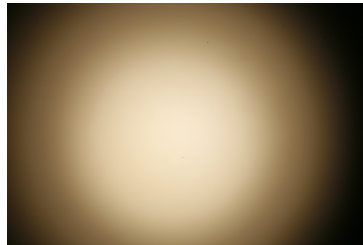

#### CREE LED

LED CXA2011  
 FWHM / FWTM 52.0° / 83.0°  
 Efficiency 78 %  
 Peak intensity 1 cd/lm  
 LEDs/each optic 1  
 Light colour White  
 Required components:  
 C12105\_LENINA-STD-BASE-CXA20  
 C12606\_LENINA-DL

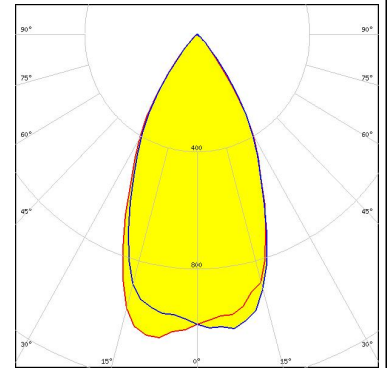

#### CREE LED

LED CXA2011  
 FWHM / FWTM 50.0° / 80.0°  
 Efficiency 86 %  
 Peak intensity 1.2 cd/lm  
 LEDs/each optic 1  
 Light colour White  
 Required components:  
 C12105\_LENINA-STD-BASE-CXA20

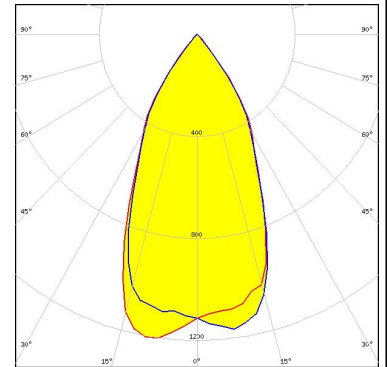

#### EVERLIGHT

LED CHI3030 19W  
 FWHM / FWTM 62.0° / 88.0°  
 Efficiency 90 %  
 Peak intensity 0.9 cd/lm  
 LEDs/each optic 1  
 Light colour White  
 Required components:  
 C13867\_LENINA-STD-BASE-VERO29  
 C12606\_LENINA-DL  
 Bender Wirth: 468 Typ L3

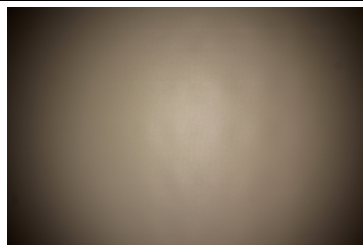

#### PHOTOMETRIC DATA (MEASURED):

#### EVERLIGHT

LED CHI3030 29W  
 FWHM / FWTM 63.0° / 92.0°  
 Efficiency 86 %  
 Peak intensity 0.8 cd/lm  
 LEDs/each optic 1  
 Light colour White

Required components:

C13867\_LENINA-STD-BASE-VERO29  
 C12606\_LENINA-DL  
 Bender Wirth: 468 Typ L3

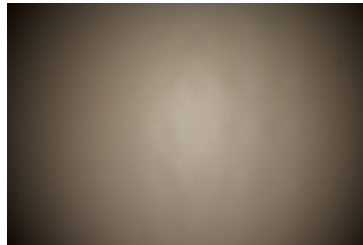

#### LUMILEDS

LED LUXEON CoB 1204/1205  
 FWHM / FWTM 55.0° / 81.0°  
 Efficiency 89 %  
 Peak intensity 1.1 cd/lm  
 LEDs/each optic 1  
 Light colour White

Required components:

C12292\_LENINA-STD-BASE-MEZ

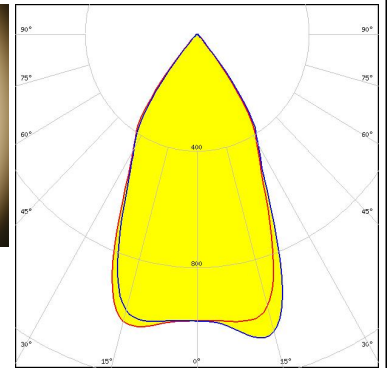

#### LUMILEDS

LED LUXEON CoB 1204/1205  
 FWHM / FWTM 57.0° / 82.0°  
 Efficiency 84 %  
 Peak intensity 1 cd/lm  
 LEDs/each optic 1  
 Light colour White

Required components:

C12292\_LENINA-STD-BASE-MEZ  
 C12606\_LENINA-DL

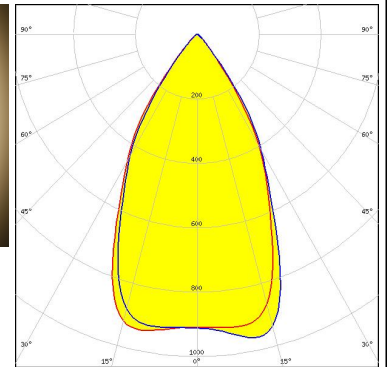

#### LUMILEDS

LED LUXEON CoB 1204HD  
 FWHM / FWTM 51.0° / 79.0°  
 Efficiency 91 %  
 Peak intensity 1.4 cd/lm  
 LEDs/each optic 1  
 Light colour White

Required components:

C11981\_LENINA-STD-BASE-COB-L110

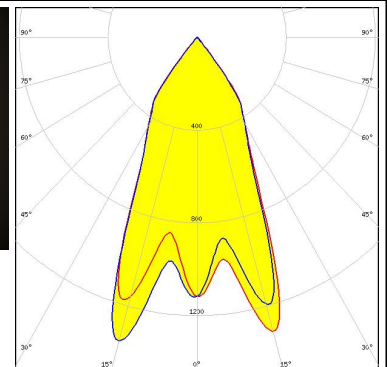
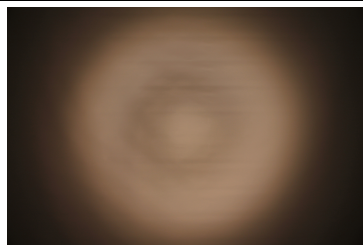

### PHOTOMETRIC DATA (MEASURED):

**LUMILEDS**  
 LED LUXEON CoB 1205HD  
 FWHM / FWTM 54.0° / 80.0°  
 Efficiency 91 %  
 Peak intensity 1.3 cd/lm  
 LEDs/each optic 1  
 Light colour White  
 Required components:  
 C11981\_LENASTD-BASE-COB-L110

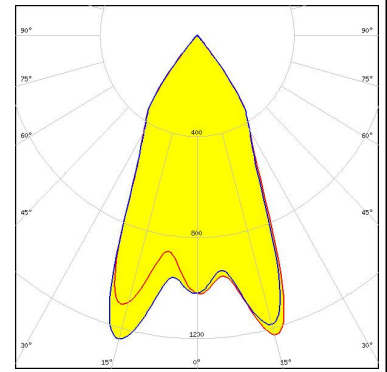

**LUMILEDS**  
 LED LUXEON CoB 1208  
 FWHM / FWTM 58.0° / 82.0°  
 Efficiency 88 %  
 Peak intensity 1 cd/lm  
 LEDs/each optic 1  
 Light colour White  
 Required components:  
 C12292\_LENASTD-BASE-MEZ

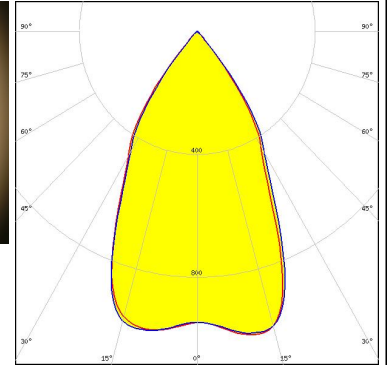
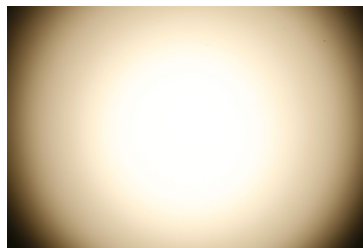

**LUMILEDS**  
 LED LUXEON CoB 1208  
 FWHM / FWTM 60.0° / 83.0°  
 Efficiency 84 %  
 Peak intensity 0.9 cd/lm  
 LEDs/each optic 1  
 Light colour White  
 Required components:  
 C12292\_LENASTD-BASE-MEZ  
 C12606\_LENINA-DL

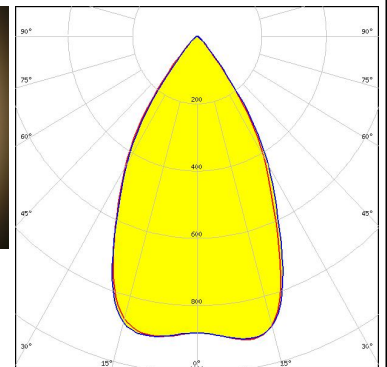
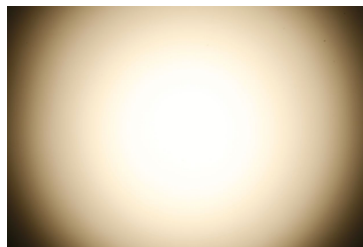

**LUMILEDS**  
 LED LUXEON CoB 1211  
 FWHM / FWTM 60.0° / 86.0°  
 Efficiency 86 %  
 Peak intensity 0.9 cd/lm  
 LEDs/each optic 1  
 Light colour White  
 Required components:  
 C13867\_LENASTD-BASE-VERO29  
 C12606\_LENINA-DL  
 Bender Wirth: 431 Typ L3

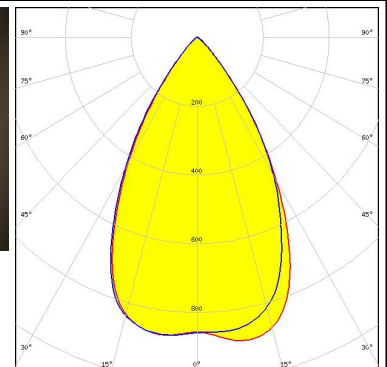
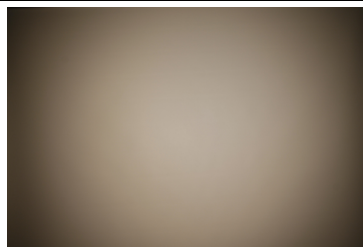



#### PHOTOMETRIC DATA (MEASURED):

#### LUMILEDS

LED LUXEON CoB 1211  
 FWHM / FWTM 60.0° / 84.0°  
 Efficiency 91 %  
 Peak intensity 1 cd/lm  
 LEDs/each optic 1  
 Light colour White  
 Required components:  
 C13867\_LENINA-STD-BASE-VERO29  
 Bender Wirth: 431 Typ L3

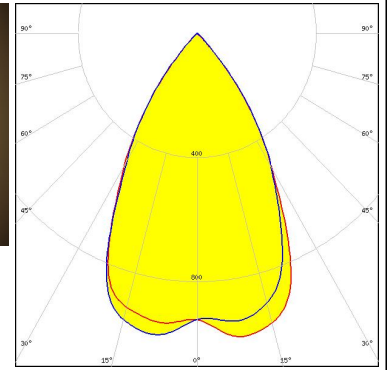

#### LUMILEDS

LED LUXEON CoB 1216/1812  
 FWHM / FWTM 58.0° / 86.0°  
 Efficiency 80 %  
 Peak intensity 0.9 cd/lm  
 LEDs/each optic 1  
 Light colour White  
 Required components:  
 C12606\_LENINA-DL  
 A.A.G. STUCCHI: 8102-G2 + S-8000-12

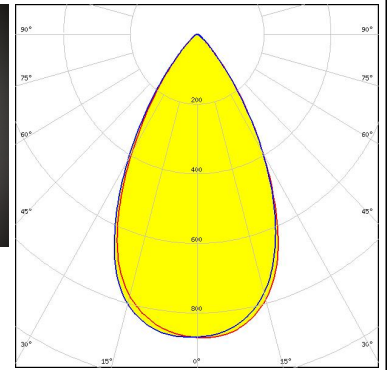
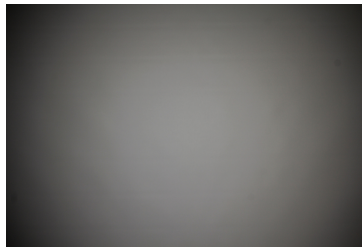

#### LUMILEDS

LED LUXEON CoB 1216/1812  
 FWHM / FWTM 58.0° / 85.0°  
 Efficiency 86 %  
 Peak intensity 1 cd/lm  
 LEDs/each optic 1  
 Light colour White  
 Required components:  
 C12692\_LENINA-STD-BASE-CLL040  
 C12606\_LENINA-DL

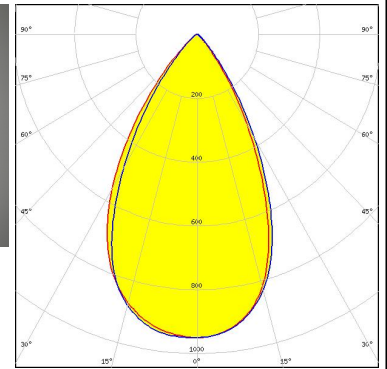

#### LUMILEDS

LED LUXEON CoB 1216/1812  
 FWHM / FWTM 58.0° / 84.0°  
 Efficiency 90 %  
 Peak intensity 1 cd/lm  
 LEDs/each optic 1  
 Light colour White  
 Required components:  
 C12692\_LENINA-STD-BASE-CLL040

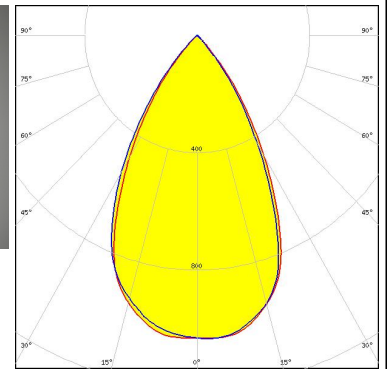

### PHOTOMETRIC DATA (MEASURED):

#### LUMILEDS

LED LUXEON CoB 1216/1812  
 FWHM / FWTM 58.0° / 85.0°  
 Efficiency 84 %  
 Peak intensity 1 cd/lm  
 LEDs/each optic 1  
 Light colour White  
 Required components:  
 A.A.G. STUCCHI: 8102-G2 + S-8000-12

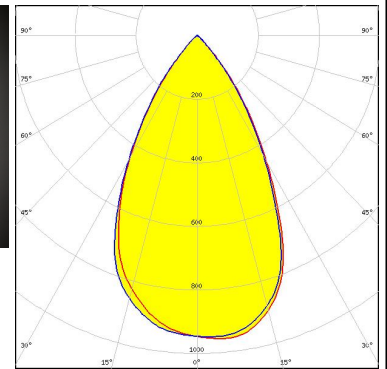
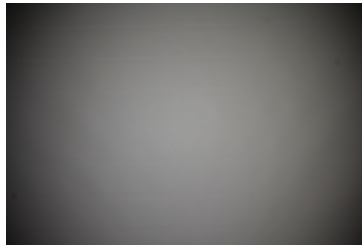

#### LUMILEDS

LED LUXEON K12  
 FWHM / FWTM 57.0° / 83.0°  
 Efficiency 83 %  
 Peak intensity 1 cd/lm  
 LEDs/each optic 1  
 Light colour White  
 Required components:  
 C12924\_LENINA-STD-BASE-LUXEON-K  
 C12606\_LENINA-DL

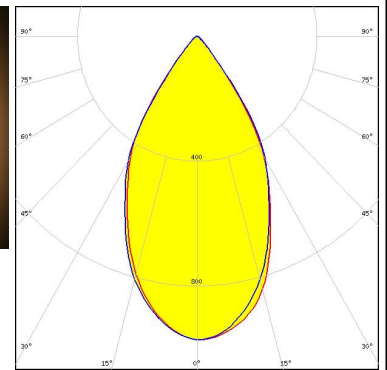
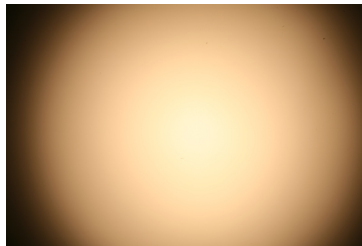

#### LUMILEDS

LED LUXEON K12  
 FWHM / FWTM 54.0° / 81.0°  
 Efficiency 88 %  
 Peak intensity 1.1 cd/lm  
 LEDs/each optic 1  
 Light colour White  
 Required components:  
 C12924\_LENINA-STD-BASE-LUXEON-K

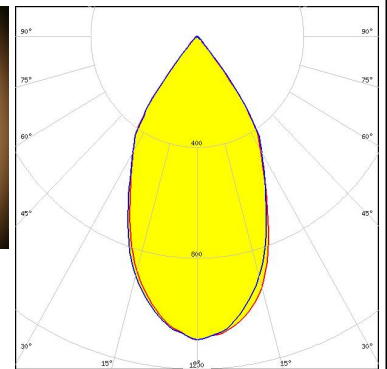
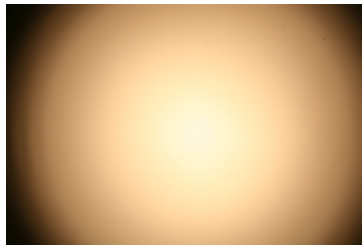

#### LUMILEDS



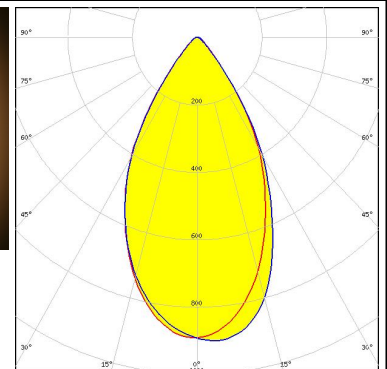
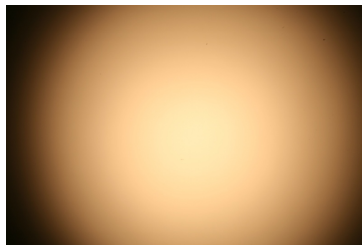

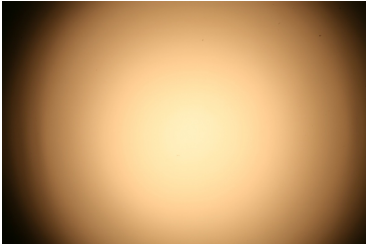
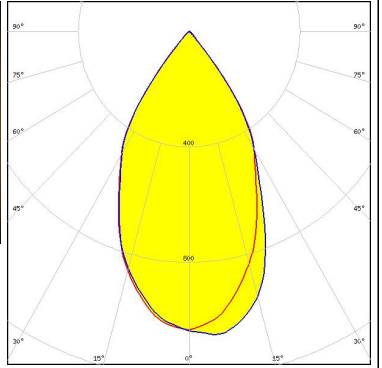
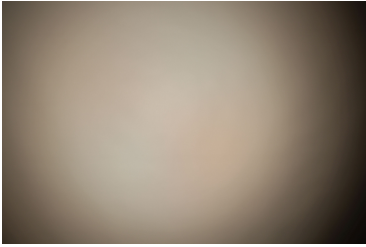
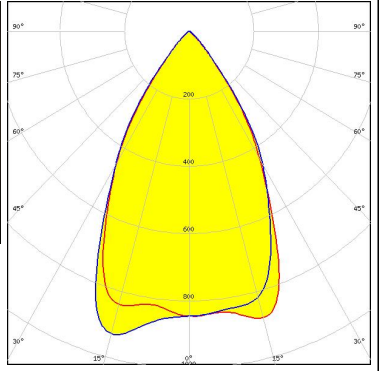
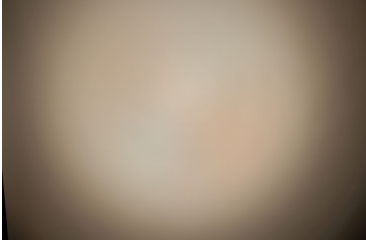
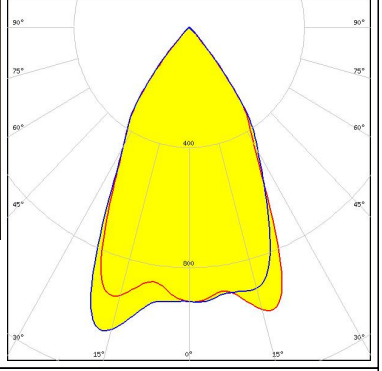
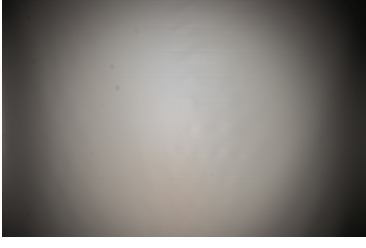
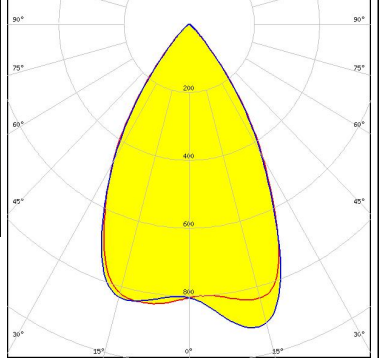

LED LUXEON K16  
 FWHM / FWTM 56.0° / 85.0°  
 Efficiency 79 %  
 Peak intensity 0.9 cd/lm  
 LEDs/each optic 1  
 Light colour White  
 Required components:  
 C12924\_LENINA-STD-BASE-LUXEON-K  
 C12606\_LENINA-DL



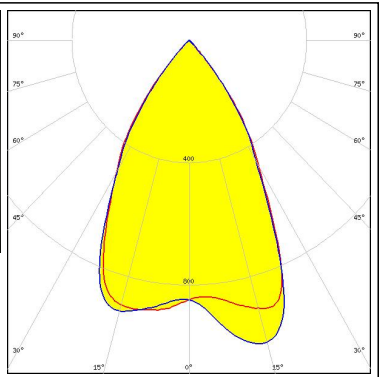

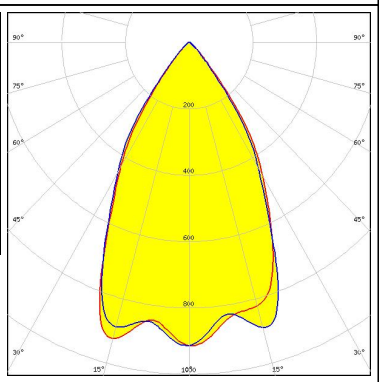

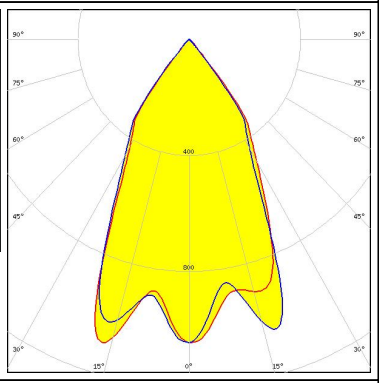

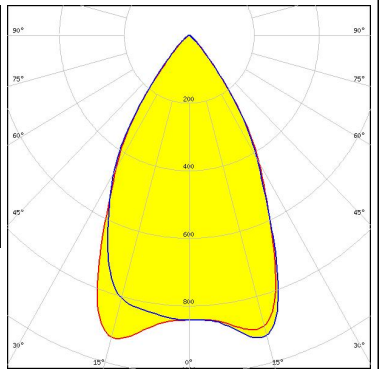
#### PHOTOMETRIC DATA (MEASURED):

<p><b>LUMILEDS</b></p> <p>LED LUXEON K16            FWHM / FWTM 55.0° / 81.0°            Efficiency 85 %            Peak intensity 1.1 cd/m            LEDs/each optic 1            Light colour White            Required components:            C12924_LENASTD-BASE-LUXEON-K</p>		
<p><b>LUMINUS</b></p> <p>LED CDM-14 (Dim-To-Warm)            FWHM / FWTM 60.0° / 85.0°            Efficiency 86 %            Peak intensity 0.9 cd/m            LEDs/each optic 1            Light colour White            Required components:            C13868_LENASTD-BASE-VERO13-18            C12606_LENINA-DL            Bender Wirth: 491 Typ L2</p>		
<p><b>LUMINUS</b></p> <p>LED CDM-14 (Dim-To-Warm)            FWHM / FWTM 58.0° / 83.0°            Efficiency 91 %            Peak intensity 1.1 cd/m            LEDs/each optic 1            Light colour White            Required components:            C13868_LENASTD-BASE-VERO13-18            Bender Wirth: 491 Typ L2</p>		
<p><b>LUMINUS</b></p> <p>LED CDM-18 (Dim-To-Warm)            FWHM / FWTM 62.0° / 86.0°            Efficiency 86 %            Peak intensity 0.9 cd/m            LEDs/each optic 1            Light colour White            Required components:            C13868_LENASTD-BASE-VERO13-18            C12606_LENINA-DL            Bender Wirth: 491 Typ L2</p>		

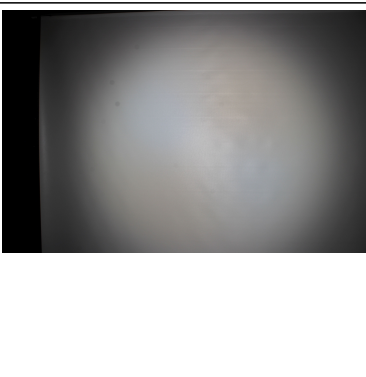
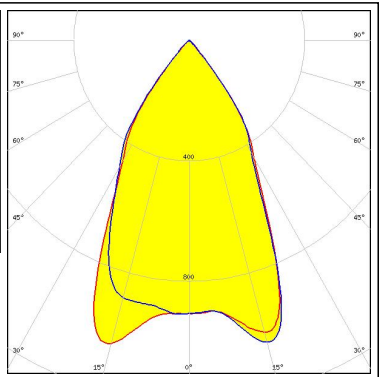
### PHOTOMETRIC DATA (MEASURED):

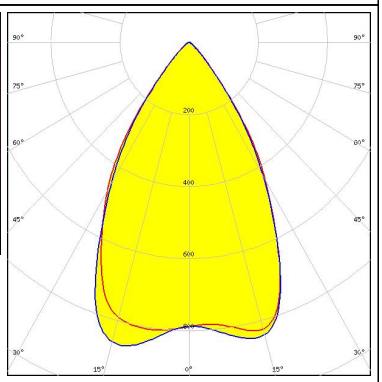
<p><b>LUMINUS</b></p> <p>LED CDM-18 (Dim-To-Warm)</p> <p>FWHM / FWTM 64.0° / 85.0°</p> <p>Efficiency 91 %</p> <p>Peak intensity 1 cd/lm</p> <p>LEDs/each optic 1</p> <p>Light colour White</p> <p>Required components: C13868_LENINA-STD-BASE-VERO13-18 Bender Wirth: 491 Typ L2</p>		
<p><b>LUMINUS</b></p> <p>LED CDM-9 (Dim-To-Warm)</p> <p>FWHM / FWTM 59.0° / 83.0°</p> <p>Efficiency 86 %</p> <p>Peak intensity 1 cd/lm</p> <p>LEDs/each optic 1</p> <p>Light colour White</p> <p>Required components: C13868_LENINA-STD-BASE-VERO13-18 C12606_LENINA-DL Bender Wirth: 490 Typ L1</p>		
<p><b>LUMINUS</b></p> <p>LED CDM-9 (Dim-To-Warm)</p> <p>FWHM / FWTM 55.0° / 81.0°</p> <p>Efficiency 90 %</p> <p>Peak intensity 1.1 cd/lm</p> <p>LEDs/each optic 1</p> <p>Light colour White</p> <p>Required components: C13868_LENINA-STD-BASE-VERO13-18 Bender Wirth: 490 Typ L1</p>		
<p><b>LUMINUS</b></p> <p>LED CTM-14 (Tunable White)</p> <p>FWHM / FWTM 60.0° / 85.0°</p> <p>Efficiency 86 %</p> <p>Peak intensity 1 cd/lm</p> <p>LEDs/each optic 1</p> <p>Light colour White</p> <p>Required components: C13867_LENINA-STD-BASE-VERO29 C12606_LENINA-DL Bender Wirth: 442 Typ L3</p>		

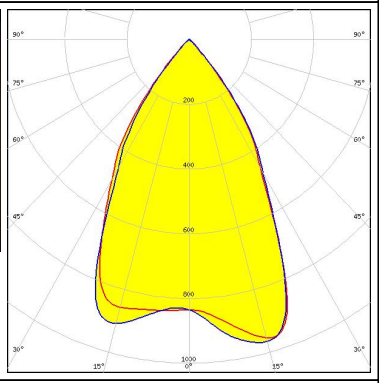
### PHOTOMETRIC DATA (MEASURED):

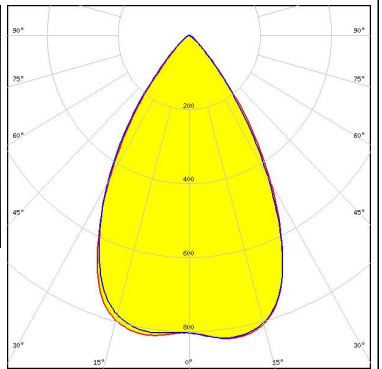
<p><b>LUMINUS</b></p> <p>LED CTM-14 (Tunable White)            FWHM / FWTM 58.0° / 83.0°            Efficiency 91 %            Peak intensity 1.1 cd/lm            LEDs/each optic 1            Light colour White</p> <p>Required components:            C13867_LENINA-STD-BASE-VERO29            Bender Wirth: 442 Typ L3</p>		
<p><b>LUMINUS</b></p> <p>LED CTM-18 (Tunable White)            FWHM / FWTM 63.0° / 87.0°            Efficiency 85 %            Peak intensity 0.9 cd/lm            LEDs/each optic 1            Light colour White</p> <p>Required components:            C13867_LENINA-STD-BASE-VERO29            C12606_LENINA-DL            Bender Wirth: 442 Typ L3</p>		
<p><b>LUMINUS</b></p> <p>LED CTM-18 (Tunable White)            FWHM / FWTM 32.0° / 76.0°            Efficiency 92 %            Peak intensity 2 cd/lm            LEDs/each optic 1            Light colour White</p> <p>Required components:            C13867_LENINA-STD-BASE-VERO29            Bender Wirth: 442 Typ L3</p>		
<p><b>LUMINUS</b></p> <p>LED CTM-22 (Tunable White)            FWHM / FWTM 63.0° / 89.0°            Efficiency 85 %            Peak intensity 0.8 cd/lm            LEDs/each optic 1            Light colour White</p> <p>Required components:            C13867_LENINA-STD-BASE-VERO29            C12606_LENINA-DL            Bender Wirth: 494 Typ L3</p>		

#### PHOTOMETRIC DATA (MEASURED):

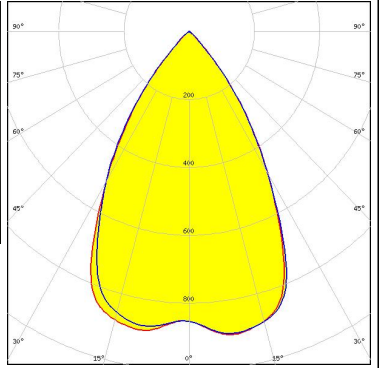
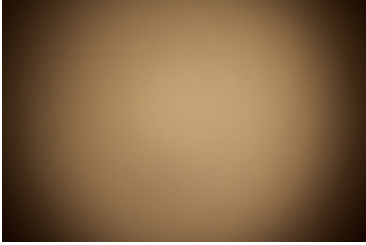
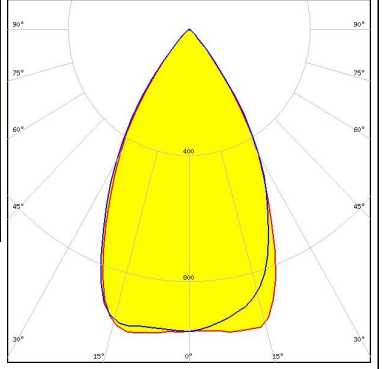
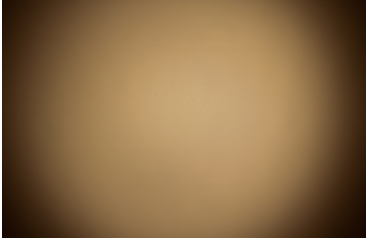
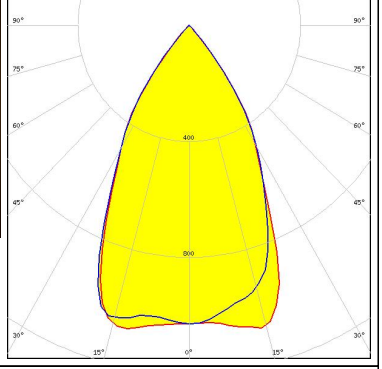
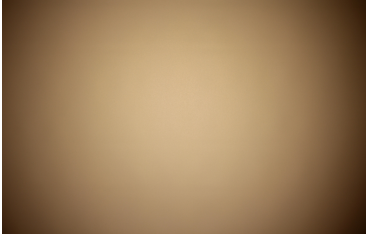
<p><b>LUMINUS</b></p> <p>LED CTM-22 (Tunable White)</p> <p>FWHM / FWTM 63.0° / 87.0°</p> <p>Efficiency 90 %</p> <p>Peak intensity 0.9 cd/lm</p> <p>LEDs/each optic 1</p> <p>Light colour White</p> <p>Required components: C13867_LENINA-STD-BASE-VERO29 Bender Wirth: 494 Typ L3</p>		
<p><b>LUMINUS</b></p> <p>LED CxM-14 (19x19)</p> <p>FWHM / FWTM 59.0° / 84.0°</p> <p>Efficiency 88 %</p> <p>Peak intensity 1 cd/lm</p> <p>LEDs/each optic 1</p> <p>Light colour White</p> <p>Required components: C12691_LENINA-STD-BASE-CLL030 C12606_LENINA-DL</p>		
<p><b>LUMINUS</b></p> <p>LED CxM-14 (19x19)</p> <p>FWHM / FWTM 58.0° / 82.0°</p> <p>Efficiency 92 %</p> <p>Peak intensity 1.1 cd/lm</p> <p>LEDs/each optic 1</p> <p>Light colour White</p> <p>Required components: C12691_LENINA-STD-BASE-CLL030</p>		
<p><b>LUMINUS</b></p> <p>LED CxM-22 (28x28)</p> <p>FWHM / FWTM 58.0° / 86.0°</p> <p>Efficiency 87 %</p> <p>Peak intensity 1 cd/lm</p> <p>LEDs/each optic 1</p> <p>Light colour White</p> <p>Required components: C12692_LENINA-STD-BASE-CLL040 C12606_LENINA-DL</p>		

#### PHOTOMETRIC DATA (MEASURED):



LED CxM-22 (28x28)  
 FWHM / FWTM 58.0° / 86.0°  
 Efficiency 92 %  
 Peak intensity 1.1 cd/lm  
 LEDs/each optic 1  
 Light colour White  
 Required components:  
 C12692\_LENINA-STD-BASE-CLL040

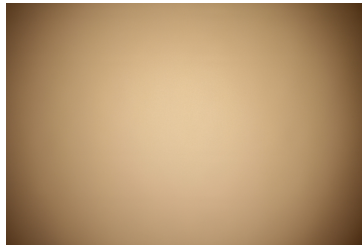

LED COB J-Type  
 FWHM / FWTM 59.0° / 84.0°  
 Efficiency 82 %  
 Peak intensity 0.9 cd/lm  
 LEDs/each optic 1  
 Light colour White  
 Required components:  
 C12292\_LENINA-STD-BASE-MEZ  
 C12606\_LENINA-DL

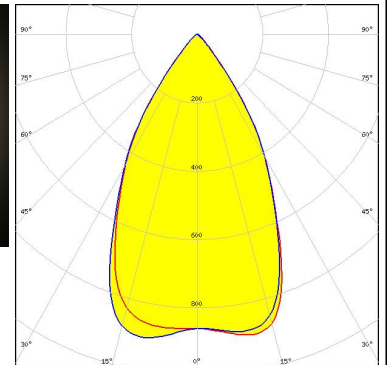
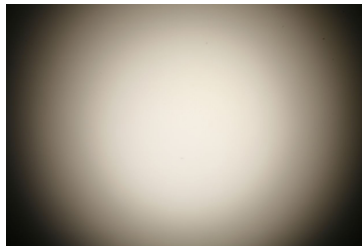

LED COB J-Type  
 FWHM / FWTM 58.0° / 82.0°  
 Efficiency 86 %  
 Peak intensity 1 cd/lm  
 LEDs/each optic 1  
 Light colour White  
 Required components:  
 C12292\_LENINA-STD-BASE-MEZ

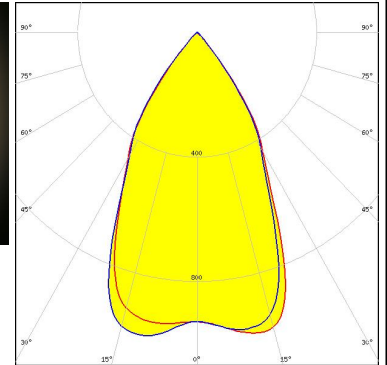
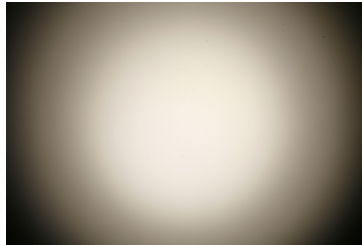

LED COB J-Type  
 FWHM / FWTM 59.0° / 84.0°  
 Efficiency 87 %  
 Peak intensity 1 cd/lm  
 LEDs/each optic 1  
 Light colour White  
 Required components:  
 C13868\_LENINA-STD-BASE-VERO13-18  
 C12606\_LENINA-DL  
 Bender Wirth: 463 Typ L2

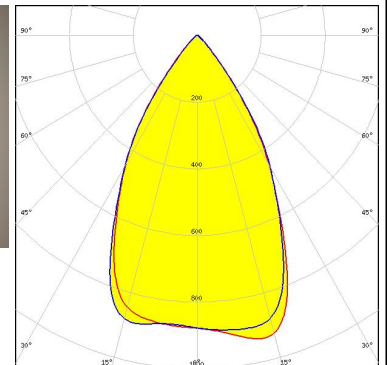
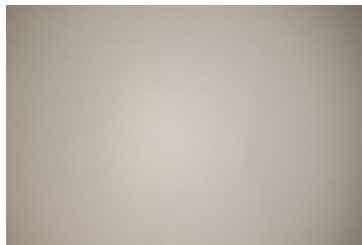

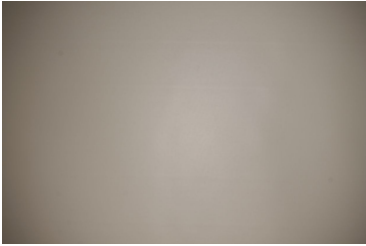
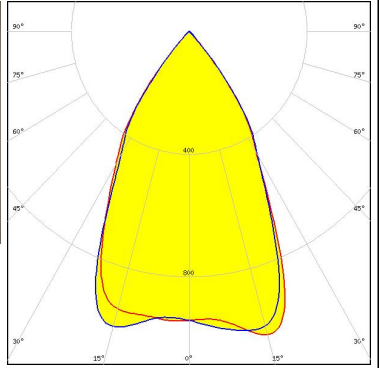
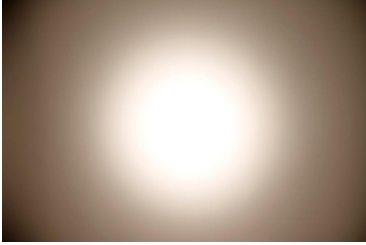
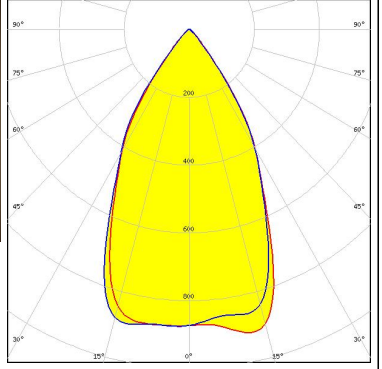
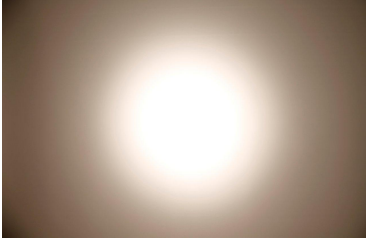
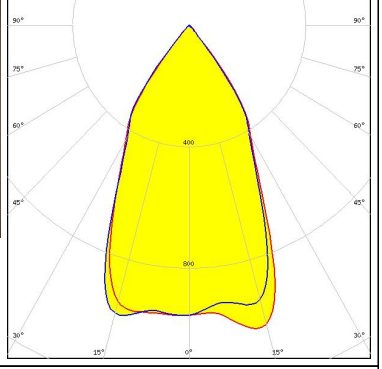
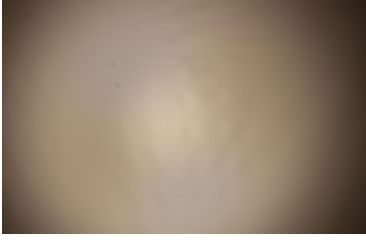
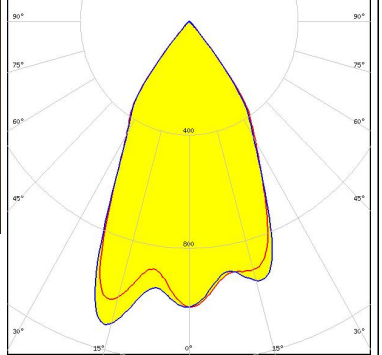

#### PHOTOMETRIC DATA (MEASURED):

<p><b>NICHIA</b></p> <p>LED COB J-Type            FWHM / FWTM 59.0° / 83.0°            Efficiency 91 %            Peak intensity 1.1 cd/lm            LEDs/each optic 1            Light colour White</p> <p>Required components:            C13868_LENINA-STD-BASE-VERO13-18            Bender Wirth: 463 Typ L2</p>		
<p><b>NICHIA</b></p> <p>LED COB L-Type (LES 11)            FWHM / FWTM 58.0° / 82.0°            Efficiency 80 %            Peak intensity 0.9 cd/lm            LEDs/each optic 1            Light colour White</p> <p>Required components:            C11981_LENINA-STD-BASE-COB-L110            C12606_LENINA-DL</p>		
<p><b>NICHIA</b></p> <p>LED COB L-Type (LES 11)            FWHM / FWTM 56.0° / 81.0°            Efficiency 85 %            Peak intensity 1 cd/lm            LEDs/each optic 1            Light colour White</p> <p>Required components:            C11981_LENINA-STD-BASE-COB-L110</p>		
<p><b>NICHIA</b></p> <p>LED NVCWJ024Z-V1MT: COB J-Type Tunable White            FWHM / FWTM 56.0° / 81.0°            Efficiency 91 %            Peak intensity 1.1 cd/lm            LEDs/each optic 1            Light colour White</p> <p>Required components:            C13868_LENINA-STD-BASE-VERO13-18            Bender Wirth: 498 Typ L2</p>		

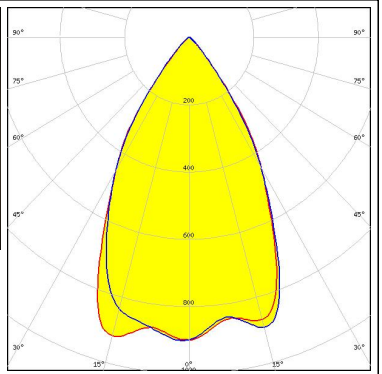

#### PHOTOMETRIC DATA (MEASURED):

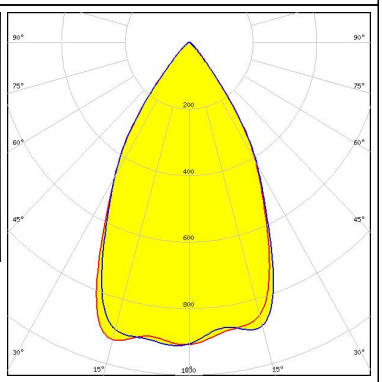
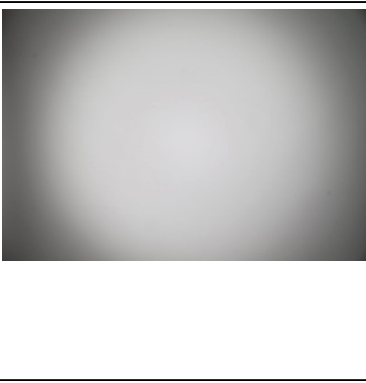
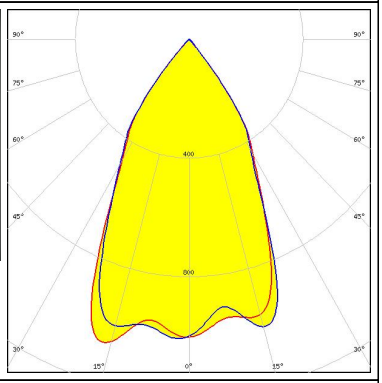
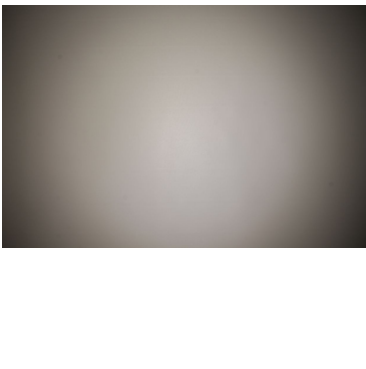
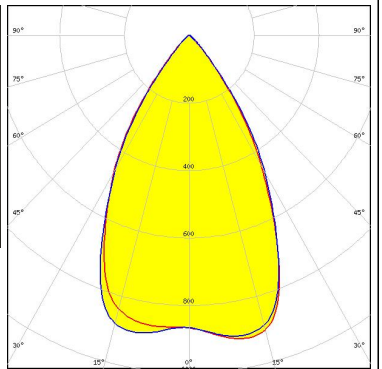
<p><b>NICHIA</b></p> <p>LED NVCWJ024Z-V1MT: COB J-Type Tunable White</p> <p>FWHM / FWTM 60.0° / 84.0°</p> <p>Efficiency 86 %</p> <p>Peak intensity 0.9 cd/m</p> <p>LEDs/each optic 1</p> <p>Light colour White</p> <p>Required components:            C13868_LENINA-STD-BASE-VERO13-18            C12606_LENINA-DL            Bender Wirth: 498 Typ L2</p>		
<p><b>OSRAM</b> Opto Semiconductors</p> <p>LED Soleriq S13</p> <p>FWHM / FWTM 59.0° / 83.0°</p> <p>Efficiency 86 %</p> <p>Peak intensity 0.9 cd/m</p> <p>LEDs/each optic 1</p> <p>Light colour White</p> <p>Required components:            C13868_LENINA-STD-BASE-VERO13-18            C12606_LENINA-DL            Bender Wirth: 437 Typ L1</p>		
<p><b>OSRAM</b> Opto Semiconductors</p> <p>LED Soleriq S13</p> <p>FWHM / FWTM 56.0° / 81.0°</p> <p>Efficiency 90 %</p> <p>Peak intensity 1.1 cd/m</p> <p>LEDs/each optic 1</p> <p>Light colour White</p> <p>Required components:            C13868_LENINA-STD-BASE-VERO13-18            Bender Wirth: 437 Typ L1</p>		
<p><b>OSRAM</b> Opto Semiconductors</p> <p>LED Soleriq S19</p> <p>FWHM / FWTM 60.0° / 85.0°</p> <p>Efficiency 87 %</p> <p>Peak intensity 0.9 cd/m</p> <p>LEDs/each optic 1</p> <p>Light colour White</p> <p>Required components:            C13867_LENINA-STD-BASE-VERO29            C12606_LENINA-DL            Bender Wirth: 462 Typ L3</p>		

#### PHOTOMETRIC DATA (MEASURED):

#### OSRAM

Opto Semiconductors

LED Soleriq S19  
 FWHM / FWTM 60.0° / 84.0°  
 Efficiency 92 %  
 Peak intensity 1 cd/lm  
 LEDs/each optic 1  
 Light colour White

Required components:

C13867\_LENINA-STD-BASE-VERO29  
 Bender Wirth: 462 Typ L3

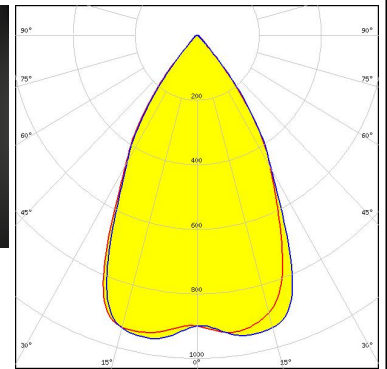
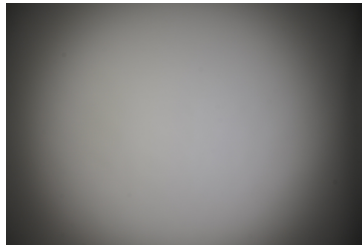

#### PHILIPS

LED Fortimo SLM L13 CoB  
 FWHM / FWTM 57.0° / 83.0°  
 Efficiency 85 %  
 Peak intensity 1 cd/lm  
 LEDs/each optic 1  
 Light colour White

Required components:

C12292\_LENINA-STD-BASE-MEZ  
 C12606\_LENINA-DL

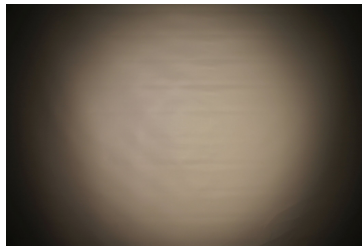

#### PHILIPS

LED Fortimo SLM L13 CoB  
 FWHM / FWTM 57.0° / 81.0°  
 Efficiency 92 %  
 Peak intensity 1.2 cd/lm  
 LEDs/each optic 1  
 Light colour White

Required components:

C12292\_LENINA-STD-BASE-MEZ

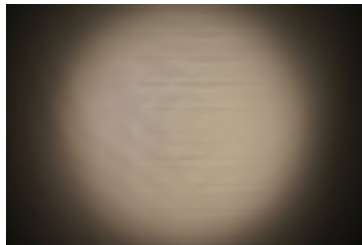

#### PHILIPS

LED Fortimo SLM L15 CoB  
 FWHM / FWTM 56.0° / 83.0°  
 Efficiency 85 %  
 Peak intensity 1 cd/lm  
 LEDs/each optic 1  
 Light colour White

Required components:

C12292\_LENINA-STD-BASE-MEZ  
 C12606\_LENINA-DL

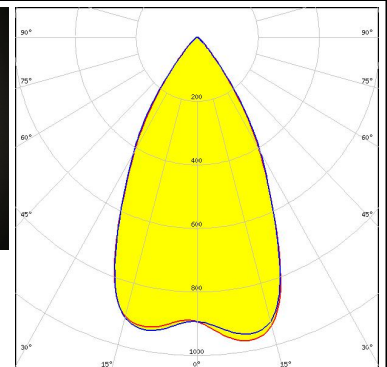
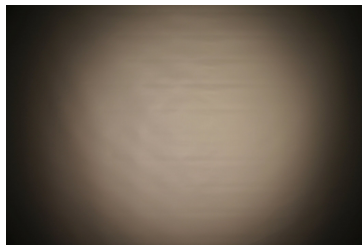

#### PHOTOMETRIC DATA (MEASURED):

### PHILIPS

LED Fortimo SLM L15 CoB  
 FWHM / FWTM 59.0° / 82.0°  
 Efficiency 91 %  
 Peak intensity 1.1 cd/lm  
 LEDs/each optic 1  
 Light colour White  
 Required components:  
 C12292\_LENINA-STD-BASE-MEZ

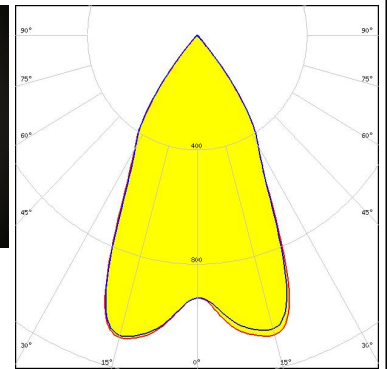

### PHILIPS

LED Fortimo SLM L19 CoB  
 FWHM / FWTM 53.0° / 81.0°  
 Efficiency 91 %  
 Peak intensity 1.1 cd/lm  
 LEDs/each optic 1  
 Light colour White  
 Required components:  
 C12692\_LENINA-STD-BASE-CLL040

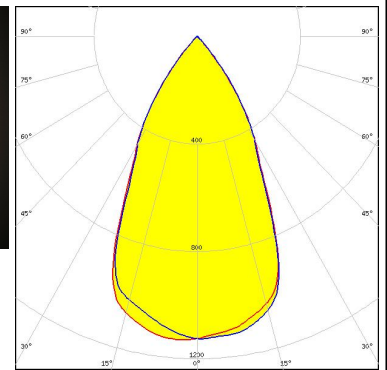
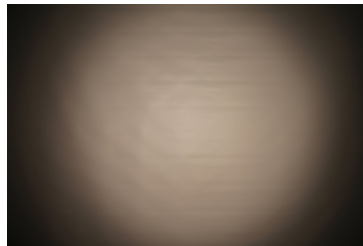

### PHILIPS

LED Fortimo SLM L19 CoB  
 FWHM / FWTM 54.0° / 83.0°  
 Efficiency 86 %  
 Peak intensity 1 cd/lm  
 LEDs/each optic 1  
 Light colour White  
 Required components:  
 C12692\_LENINA-STD-BASE-CLL040  
 C12606\_LENINA-DL

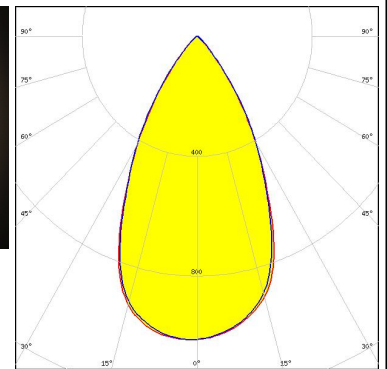
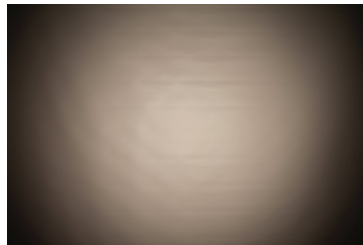

### PHILIPS

LED Fortimo SLM L23 CoB  
 FWHM / FWTM 39.0° / 76.0°  
 Efficiency 92 %  
 Peak intensity 1.7 cd/lm  
 LEDs/each optic 1  
 Light colour White  
 Required components:  
 C12692\_LENINA-STD-BASE-CLL040

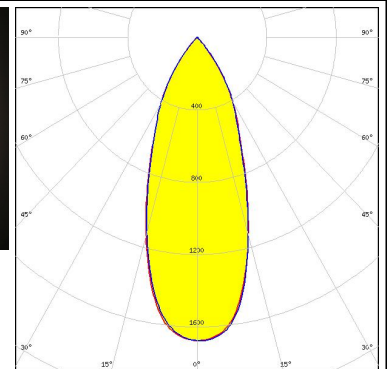
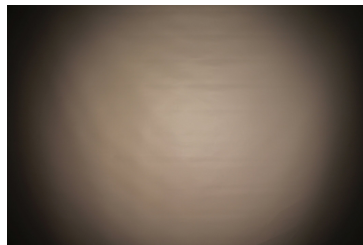

#### PHOTOMETRIC DATA (MEASURED):

### PHILIPS

LED Fortimo SLM L23 CoB  
 FWHM / FWTM 57.0° / 84.0°  
 Efficiency 85 %  
 Peak intensity 1 cd/lm  
 LEDs/each optic 1  
 Light colour White  
 Required components:  
 C12292\_LENINA-STD-BASE-MEZ  
 C12606\_LENINA-DL

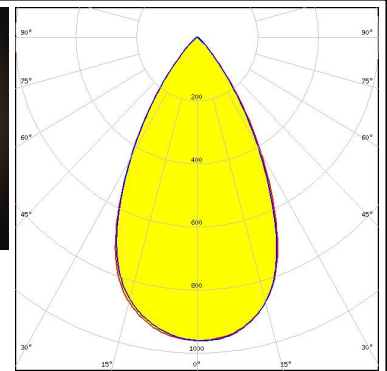
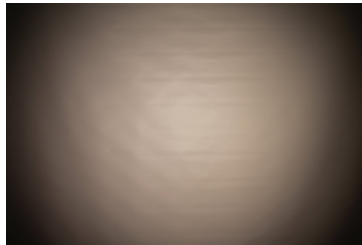

### SAMSUNG

LED LC016D / LC019D / LC026D / LC033D  
 FWHM / FWTM 57.0° / 82.0°  
 Efficiency 91 %  
 Peak intensity 1 cd/lm  
 LEDs/each optic 1  
 Light colour White  
 Required components:  
 C12691\_LENINA-STD-BASE-CLL030

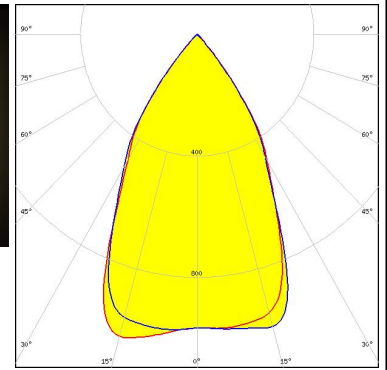
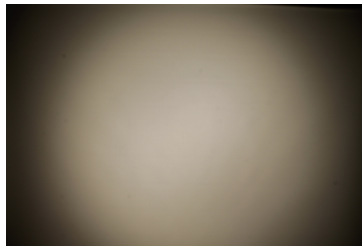

### SAMSUNG

LED LC016D / LC019D / LC026D / LC033D  
 FWHM / FWTM 59.0° / 84.0°  
 Efficiency 87 %  
 Peak intensity 1 cd/lm  
 LEDs/each optic 1  
 Light colour White  
 Required components:  
 C12691\_LENINA-STD-BASE-CLL030  
 C12606\_LENINA-DL

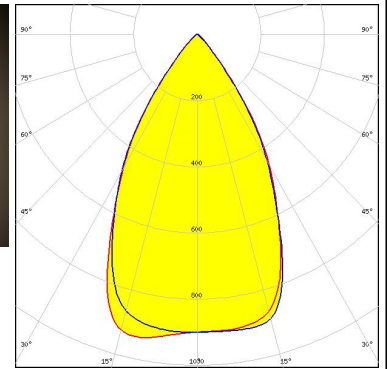
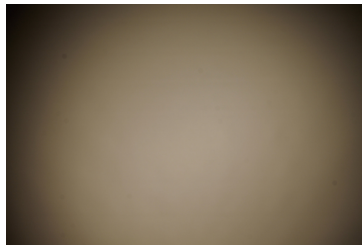

### SAMSUNG

LED LC026B / 033B / 040B  
 FWHM / FWTM 61.0° / 85.0°  
 Efficiency 86 %  
 Peak intensity 0.9 cd/lm  
 LEDs/each optic 1  
 Light colour White  
 Required components:  
 C13868\_LENINA-STD-BASE-VERO13-18  
 C12606\_LENINA-DL  
 Bender Wirth: 450 Typ L2

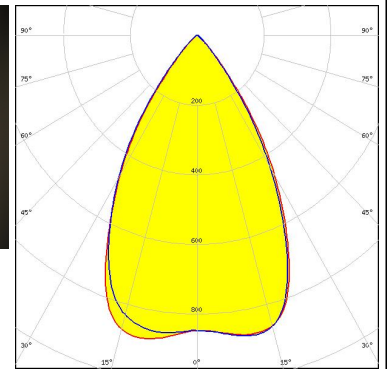
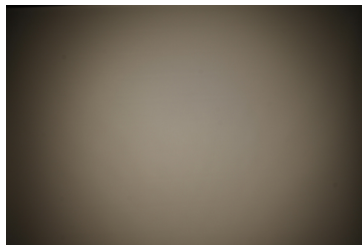

#### PHOTOMETRIC DATA (MEASURED):

### SAMSUNG

LED LC026B / 033B / 040B  
 FWHM / FWTM 61.0° / 84.0°  
 Efficiency 91 %  
 Peak intensity 1 cd/lm  
 LEDs/each optic 1  
 Light colour White  
 Required components:  
 C13868\_LENINA-STD-BASE-VERO13-18  
 Bender Wirth: 450 Typ L2

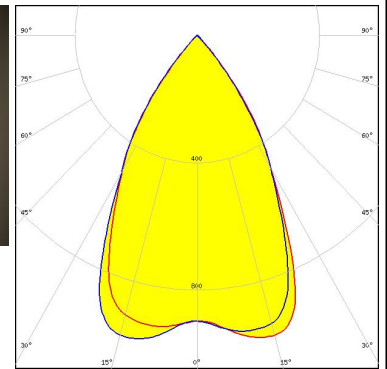
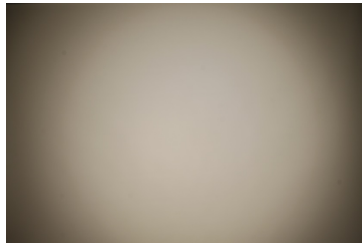

### SAMSUNG

LED LC040D / LC060D / LC080D  
 FWHM / FWTM 59.0° / 85.0°  
 Efficiency 86 %  
 Peak intensity 0.9 cd/lm  
 LEDs/each optic 1  
 Light colour White  
 Required components:  
 C12692\_LENINA-STD-BASE-CLL040  
 C12606\_LENINA-DL

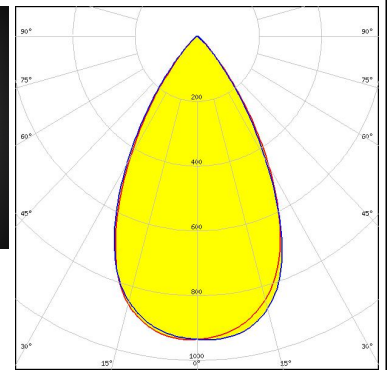
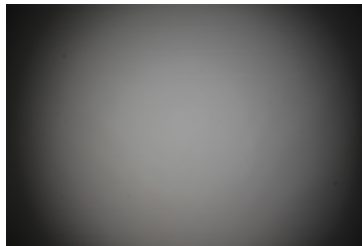

### SAMSUNG

LED LC040D / LC060D / LC080D  
 FWHM / FWTM 59.0° / 84.0°  
 Efficiency 91 %  
 Peak intensity 1 cd/lm  
 LEDs/each optic 1  
 Light colour White  
 Required components:  
 C12692\_LENINA-STD-BASE-CLL040

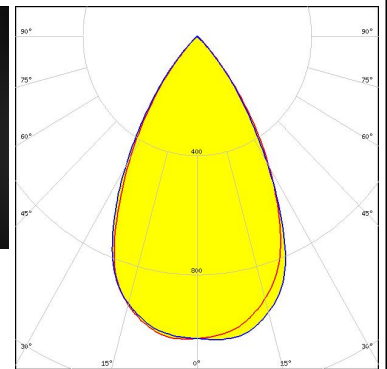
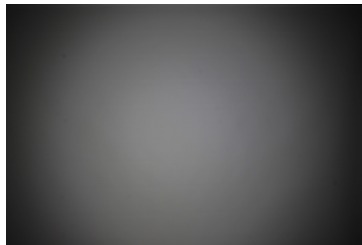





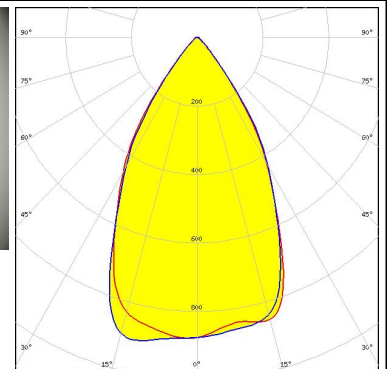

SEOUL SEMICONDUCTOR

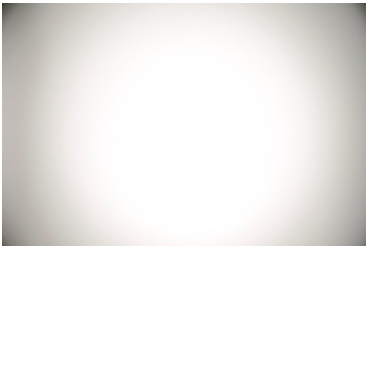
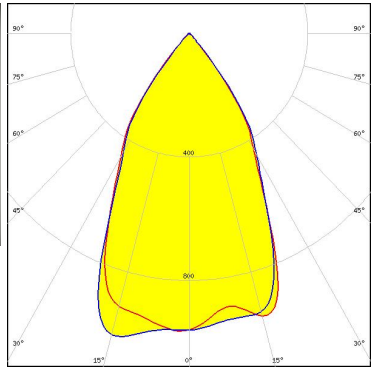
LED ZC12/18  
 FWHM / FWTM 59.0° / 84.0°  
 Efficiency 84 %  
 Peak intensity 0.9 cd/lm  
 LEDs/each optic 1  
 Light colour White  
 Required components:  
 C12691\_LENINA-STD-BASE-CLL030  
 C12606\_LENINA-DL

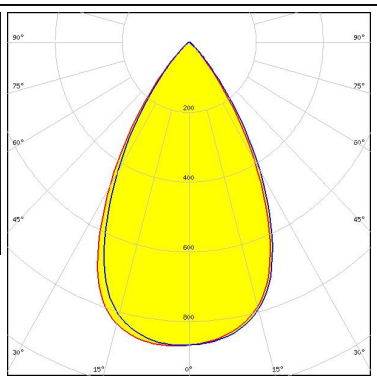

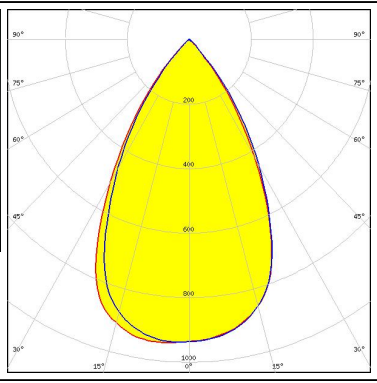
#### PHOTOMETRIC DATA (MEASURED):

<p><b>SEOL</b> SEOUL SEMICONDUCTOR</p> <p>LED ZC12/18 FWHM / FWTM 57.0° / 82.0° Efficiency 88 % Peak intensity 1 cd/lm LEDs/each optic 1 Light colour White Required components: C12691_LENINA-STD-BASE-CLL030</p>		
<p><b>SEOL</b> SEOUL SEMICONDUCTOR</p> <p>LED ZC25/40/60 FWHM / FWTM 60.0° / 86.0° Efficiency 82 % Peak intensity 0.9 cd/lm LEDs/each optic 1 Light colour White Required components: C12692_LENINA-STD-BASE-CLL040 C12606_LENINA-DL</p>		
<p><b>SEOL</b> SEOUL SEMICONDUCTOR</p> <p>LED ZC25/40/60 FWHM / FWTM 60.0° / 85.0° Efficiency 86 % Peak intensity 0.9 cd/lm LEDs/each optic 1 Light colour White Required components: C12692_LENINA-STD-BASE-CLL040</p>		
<h2>SHARP</h2>		
<p>LED Mega Zenigata (GW5DGC) FWHM / FWTM 45.0° / 80.0° Efficiency 78 % LEDs/each optic 1 Light colour White Required components: C12292_LENINA-STD-BASE-MEZ C12606_LENINA-DL</p>		

#### PHOTOMETRIC DATA (MEASURED):

### SHARP

LED Mega Zenigata (GW5DGC)  
 FWHM / FWTM 41.0° / 77.0°  
 Efficiency 86 %  
 LEDs/each optic 1  
 Light colour White  
 Required components:  
 C12292\_LENINA-STD-BASE-MEZ

### SHARP

LED Mega Zenigata (GW6DME)  
 FWHM / FWTM 57.0° / 82.0°  
 Efficiency 87 %  
 Peak intensity 1.1 cd/lm  
 LEDs/each optic 1  
 Light colour White  
 Required components:  
 C12292\_LENINA-STD-BASE-MEZ

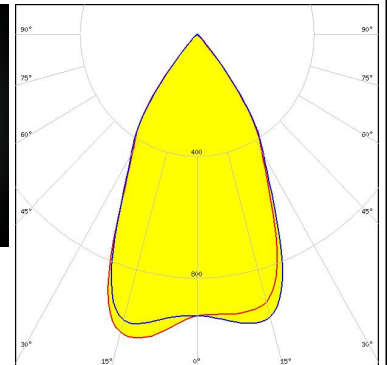
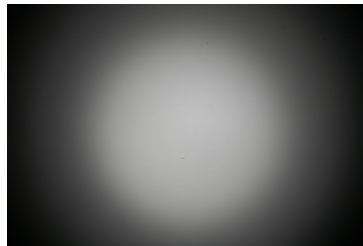

### SHARP

LED Mega Zenigata (GW6DME)  
 FWHM / FWTM 59.0° / 83.0°  
 Efficiency 83 %  
 Peak intensity 0.9 cd/lm  
 LEDs/each optic 1  
 Light colour White  
 Required components:  
 C12292\_LENINA-STD-BASE-MEZ  
 C12606\_LENINA-DL

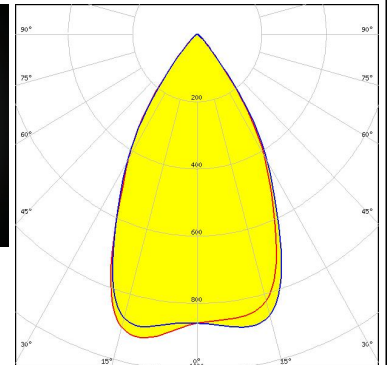
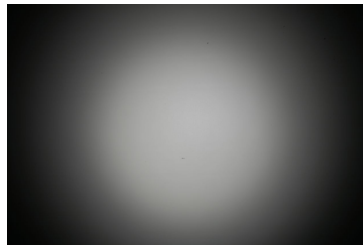

### TRIDONIC

LED SLE G7 LES15  
 FWHM / FWTM 59.0° / 82.0°  
 Efficiency 92 %  
 Peak intensity 1.1 cd/lm  
 LEDs/each optic 1  
 Light colour White  
 Required components:  
 C12691\_LENINA-STD-BASE-CLL030

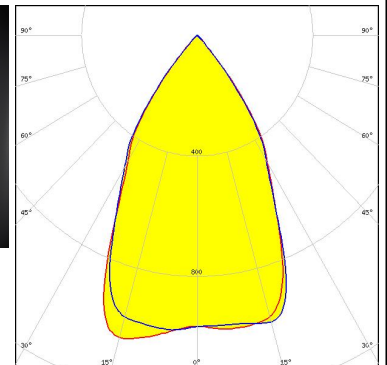
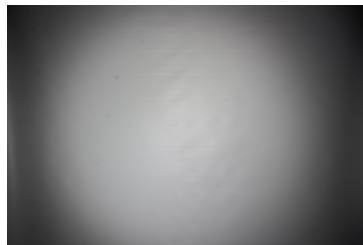

### PHOTOMETRIC DATA (MEASURED):

#### TRIDONIC

LED SLE G7 LES17 H  
FWHM / FWTM 56.0° / 82.0°  
Efficiency 90 %  
Peak intensity 1 cd/lm  
LEDs/each optic 1  
Light colour White  
Required components:  
C14547\_LENINA-ADAPTER-B

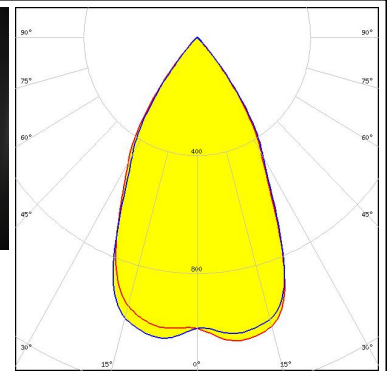
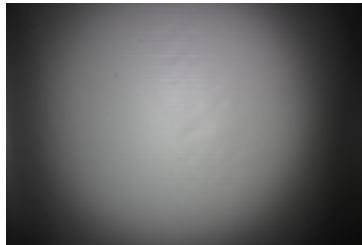





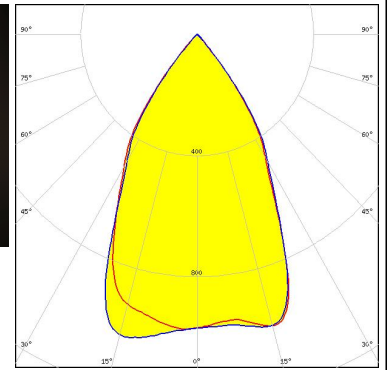
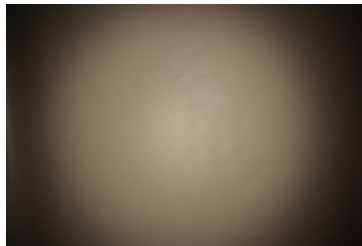

#### XICATO

LED XOB 14.5 mm  
FWHM / FWTM 58.0° / 82.0°  
Efficiency 91 %  
Peak intensity 1 cd/lm  
LEDs/each optic 1  
Light colour White  
Required components:  
C12691\_LENINA-STD-BASE-CLL030

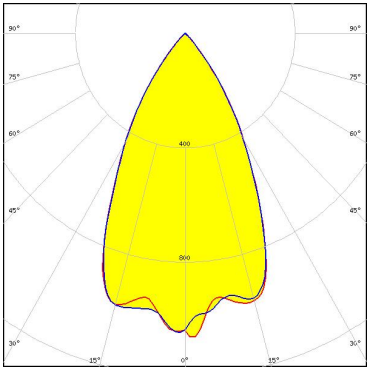

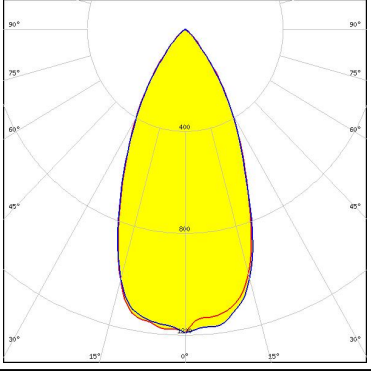

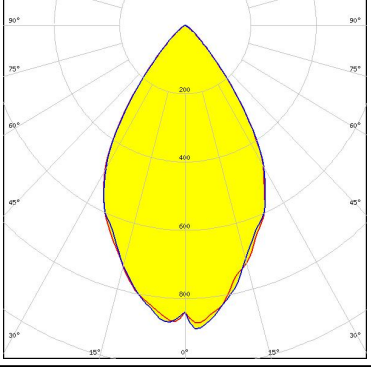

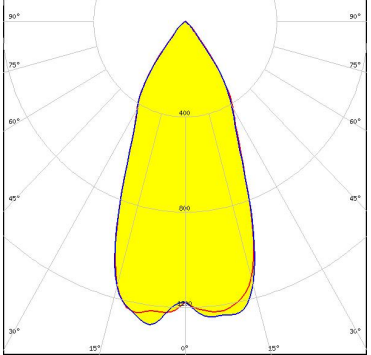

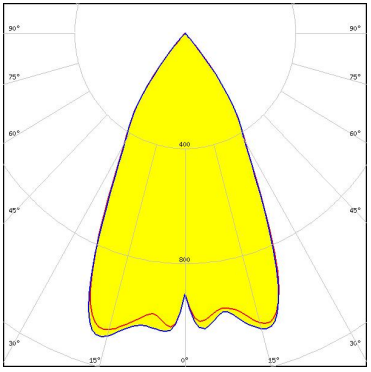

#### PHOTOMETRIC DATA (SIMULATED):

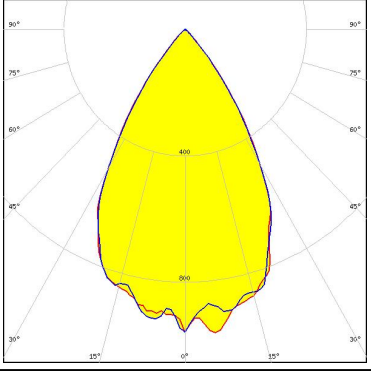
<p></p> <p>LED V10 Gen7            FWHM / FWTM 55.0° / 81.0°            Efficiency 85 %            Peak intensity 1.1 cd/lm            LEDs/each optic 1            Light colour White</p> <p>Required components:            C13868_LENINA-STD-BASE-VERO13-18            C12606_LENINA-DL            Bender Wirth: 486 Typ L1</p>	
<p></p> <p>LED V13 Gen7            FWHM / FWTM 48.0° / 82.0°            Efficiency 88 %            Peak intensity 1.2 cd/lm            LEDs/each optic 1            Light colour White</p> <p>Required components:            C12606_LENINA-DL            IDEAL: 50-2103CT + 50-2100AN</p>	
<p></p> <p>LED V13 Gen7            FWHM / FWTM 63.0° / 91.0°            Efficiency 87 %            Peak intensity 0.9 cd/lm            LEDs/each optic 1            Light colour White</p> <p>Required components:            C13868_LENINA-STD-BASE-VERO13-18            C12606_LENINA-DL            Bender Wirth: 477 Typ L1</p>	
<p></p> <p>LED V13 Gen7            FWHM / FWTM 46.0° / 79.0°            Efficiency 90 %            Peak intensity 1.3 cd/lm            LEDs/each optic 1            Light colour White</p> <p>Required components:            IDEAL: 50-2103CT + 50-2100AN</p>	

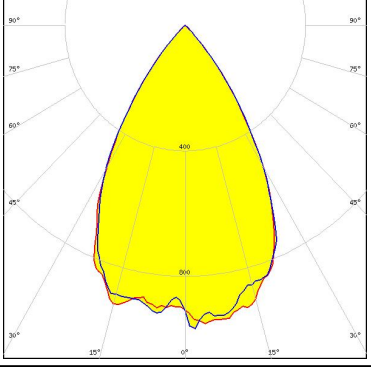
### PHOTOMETRIC DATA (SIMULATED):

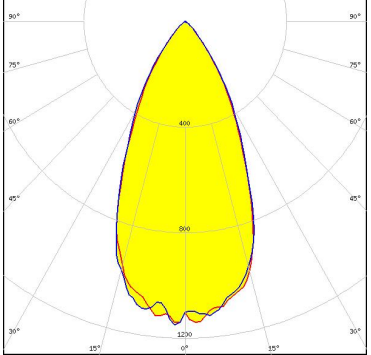
<p></p> <p>LED V13 Gen7            FWHM / FWTM 50.0° / 79.0°            Efficiency 90 %            Peak intensity 1.1 cd/lm            LEDs/each optic 1            Light colour White            Required components:            C13868_LENASTD-BASE-VERO13-18            Bender Wirth: 477 Typ L1</p>	
<p></p> <p>LED V22 Gen7            FWHM / FWTM 61.0° / 82.0°            Efficiency 87 %            Peak intensity 1 cd/lm            LEDs/each optic 1            Light colour White            Required components:            C13867_LENASTD-BASE-VERO29            C12606_LENINA-DL            Bender Wirth: 431 Typ L3</p>	
<p></p> <p>LED V22 Gen7            FWHM / FWTM 61.0° / 84.0°            Efficiency 90 %            Peak intensity 1 cd/lm            LEDs/each optic 1            Light colour White            Required components:            C13867_LENASTD-BASE-VERO29            Bender Wirth: 431 Typ L3</p>	
<p></p> <p>LED CXA/B 30xx            FWHM / FWTM 49.0° / 81.0°            Efficiency 84 %            Peak intensity 1.2 cd/lm            LEDs/each optic 1            Light colour White            Required components:            C12606_LENINA-DL            IDEAL: 50-2234C + 50-2100LN</p>	

#### PHOTOMETRIC DATA (SIMULATED):

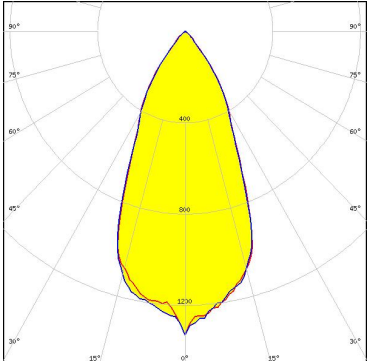
<p><b>CREE</b> LED</p> <p>LED: CXA/B 30xx            FWHM / FWTM: 46.0° / 80.0°            Efficiency: 89 %            Peak intensity: 1.3 cd/lm            LEDs/each optic: 1            Light colour: White            Required components:            IDEAL: 50-2234C + 50-2100LN</p>	
<p><b>LUMINUS</b></p> <p>LED: CxM-14 (19x19)            FWHM / FWTM: 57.0° / 82.0°            Efficiency: 90 %            Peak intensity: 1 cd/lm            LEDs/each optic: 1            Light colour: White            Required components:            C13868_LENINA-STD-BASE-VERO13-18            Bender Wirth: 433 Typ L1</p>	
<p><b>LUMINUS</b></p> <p>LED: CxM-14 (19x19)            FWHM / FWTM: 60.0° / 83.0°            Efficiency: 86 %            Peak intensity: 1 cd/lm            LEDs/each optic: 1            Light colour: White            Required components:            C13868_LENINA-STD-BASE-VERO13-18            C12606_LENINA-DL            Bender Wirth: 433 Typ L1</p>	
<p><b>LUMINUS</b></p> <p>LED: CxM-9 (13.5x13.5)            FWHM / FWTM: 54.0° / 80.0°            Efficiency: 90 %            Peak intensity: 1.1 cd/lm            LEDs/each optic: 1            Light colour: White            Required components:            C13868_LENINA-STD-BASE-VERO13-18</p>	

#### PHOTOMETRIC DATA (SIMULATED):



**LED** CxM-9 (13.5x13.5)  
**FWHM / FWTM** 57.0° / 82.0°  
**Efficiency** 86 %  
**Peak intensity** 1 cd/lm  
**LEDs/each optic** 1  
**Light colour** White  
**Required components:**  
 C13868\_LENINA-STD-BASE-VERO13-18  
 C12606\_LENINA-DL  
 Bender Wirth: 434 Typ L1



**LED** Soleriq S15  
**FWHM / FWTM** 56.0° / 81.0°  
**Efficiency** 90 %  
**Peak intensity** 1.1 cd/lm  
**LEDs/each optic** 1  
**Light colour** White  
**Required components:**  
 C12691\_LENINA-STD-BASE-CLL030

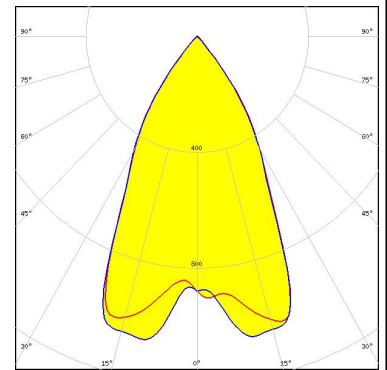

SEOUL SEMICONDUCTOR

**LED** ZC12/18  
**FWHM / FWTM** 57.0° / 82.0°  
**Efficiency** 90 %  
**Peak intensity** 1 cd/lm  
**LEDs/each optic** 1  
**Light colour** White  
**Required components:**  
 C13868\_LENINA-STD-BASE-VERO13-18  
 Bender Wirth: 433 Typ L1



SEOUL SEMICONDUCTOR

**LED** ZC12/18  
**FWHM / FWTM** 60.0° / 83.0°  
**Efficiency** 86 %  
**Peak intensity** 1 cd/lm  
**LEDs/each optic** 1  
**Light colour** White  
**Required components:**  
 C13868\_LENINA-STD-BASE-VERO13-18  
 C12606\_LENINA-DL  
 Bender Wirth: 433 Typ L1

### PHOTOMETRIC DATA (SIMULATED):

	
SEOL SEMICONDUCTOR	
LED	ZC4/6
FWHM / FWTM	54.0° / 80.0°
Efficiency	90 %
Peak intensity	1.1 cd/lm
LEDs/each optic	1
Light colour	White
Required components:	
C13868_LENINA-STD-BASE-VERO13-18	
Bender Wirth: 434 Typ L1	
<hr/>	
	
SEOL SEMICONDUCTOR	
LED	ZC4/6
FWHM / FWTM	57.0° / 82.0°
Efficiency	86 %
Peak intensity	1 cd/lm
LEDs/each optic	1
Light colour	White
Required components:	
C13868_LENINA-STD-BASE-VERO13-18	
C12606_LENINA-DL	
Bender Wirth: 434 Typ L1	

### GENERAL INFORMATION:

NOTE: The typical beam angle will be changed by different color, chip size and chip position tolerance. The typical total beam angle is the full angle measured where the luminous intensity is half of the peak value.

Due to use of high power COB's with this product, special attention to proper thermal design is highly recommended. LEDiL has no liability for direct, indirect or consecutive damages arising from the LEDiL products being used outside of the recommended temperature range.

### MATERIALS:

As part of our continuous research and improvement processes, and to ensure the best possible quality and availability of our products, LEDiL reserves the right to change material grades without notice.

### PRODUCT DATA USER AGREEMENT AND DISCLAIMER:

The measured data in the provided downloadable LEDiL Product Datasheets and Mechanical 2D-Drawings is rounded and provided as reference for planning. LEDiL Oy's optical specifications have been verified by conducting performance testing of the products in accordance with the company's quality system. The reported data are averaged results of multiple measurements with typical variation. LEDiL Oy reserves the right to without prior notification make changes and improvements to its products.

LEDiL Oy assumes neither warranty, nor guarantee nor any other liability of any kind for the contents and correctness of the provided data. The provided data has been generated with highest diligence but the provided data may in reality not represent the complete possible variation range of all intrinsic parameters. Therefore, in certain cases a deviation from the provided data could occur.

LEDiL Oy reserves the right to undertake technical changes of its products without further notification which could lead to changes in the provided data. LEDiL Oy assumes no liability of any kind for the possible deviation from any provided data or any other damage resulting from the usage of the provided data.

The user agrees to this disclaimer and user agreement with the download or usage of the provided files.

#### LEDiL Oy

Joensuunkatu 13  
FI-24240 SALO  
Finland

#### LEDiL Inc.

228 West Page Street  
Suite D  
Sycamore IL 60178  
USA

#### Ledil Optics Technology (Shenzhen) Co., Ltd.

# 405 , Block B  
Casic Motor Building  
Shenzhen 518057  
P.R.CHINA

#### Local sales and technical support

[www.ledil.com/  
where\\_to\\_buy](http://www.ledil.com/where_to_buy)

#### Shipping locations

Salo, Finland  
Hong Kong, China

#### Distribution Partners

[www.ledil.com/  
where\\_to\\_buy](http://www.ledil.com/where_to_buy)