

SUMMARY



Image is for illustrative purpose only

Wires

Low voltage 4

Series 3S
Termination type Male solder
IP rating 50
AWG wire size 22.00 - 14.00
Cable Ø 2.60 - 4.20 mm
Status active
Matching parts [ERA.3S.304.CLL](#)

Download

[Request a quote](#)
[Catalog](#)

TECHNICAL DETAILS

Mechanics

Shell Style/Model FFA*: Straight plug, cable collet
Keying Hermaphroditic keying (half moon insert) with male pin 1
Housing Material Brass (chrome plated [SAE AMS 2460]) shell and collet nut, nickel plated [SAE AMS QQ N 290] brass latch sleeve and mid pieces
Weight 56.06 g

Performance

Configuration 3S.304 : 4 Low Voltage
Insulator L: PEEK (UL 94 / V-0/1.5)
Rated Current 18 Amps

Specifications

Contact Type: Solder
Vtest: 1500 V (AC), 2100 V (DC)

Others

Endurance (Shell): 5000 mating cycles
Temp (min / max): -55° C / +250° C
Humidity (max): <=95% [at 60 deg C / 140 F]

LEMO products and services are provided "as is". LEMO makes no warranties or representations with regard to LEMO product & services or use of them, express, implied or statutory, including for accuracy, completeness, or security. The user is fully responsible for his products and applications using LEMO components.

Vibration: 15 g [10 Hz - 2000 Hz]
 Shock Resistance: 100 g [6 ms]
 Climatical Category: 50/175/21
 Shielding (min): 75 dB (10 MHz)
 Shielding (min): 40 dB (1 GHz)
 Salt Spray Corrosion: >144 hr

DRAWINGS

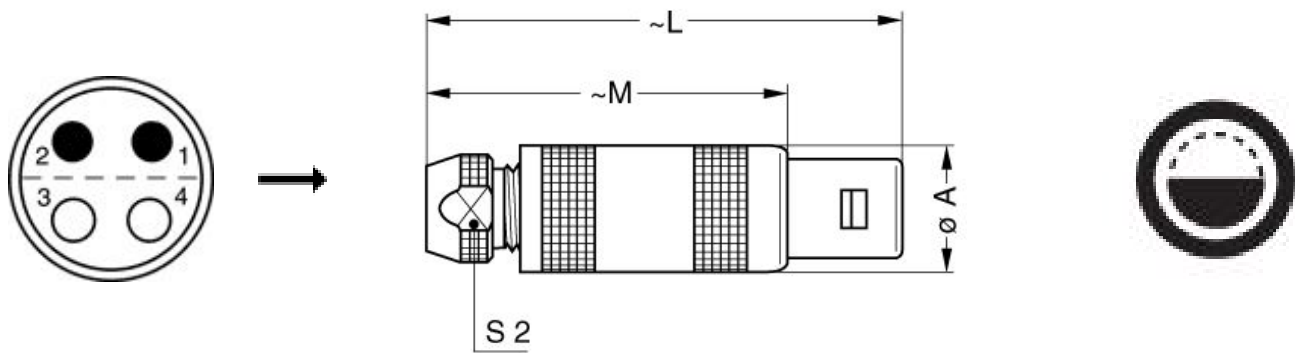

Dimensions

	A	L	M	S2
mm.	17.8	61	46	14
in.	0,70	2,40	1,81	0,55

RECOMMENDED BY LEMO







Tools

Spanner wrench: [DCP.91.023.TN](#)

Cables

CMN.04.T28.031PGCE	PVC	GREY	
CMN.04.T28.031PGZE		Grey	

LEMO products and services are provided "as is". LEMO makes no warranties or representations with regard to LEMO product & services or use of them, express, implied or statutory, including for accuracy, completeness, or security. The user is fully responsible for his products and applications using LEMO components.

CMN.04.T28.031PNCE	PVC	Black	
CMN.04.T28.031PNZE			
CMN.04.T28.031QGC	TPR	Grey	
40080	PVC	Black	
40086	PVC	Blue	
40140	PVC	Black	
40240	PTFE	White	
4041	PVC	Grey	
4050	PVC	Black	
4260	PTFE	White	

LEMO products and services are provided "as is". LEMO makes no warranties or representations with regard to LEMO product & services or use of them, express, implied or statutory, including for accuracy, completeness, or security. The user is fully responsible for his products and applications using LEMO components.