



WSE26I-24162100A00

W26

COMPACT PHOTOELECTRIC SENSORS

SICK
Sensor Intelligence.



Illustration may differ

Ordering information

| Type | Part no. |
|--------------------|----------|
| WSE26I-24162100A00 | 1088332 |

Other models and accessories → www.sick.com/W26



Detailed technical data

Features

| | | | | | | | |
|--|---|----------|--|-----------|---|------------|---|
| Device type | Photoelectric sensors | | | | | | |
| Sensor/ detection principle | Through-beam photoelectric sensor | | | | | | |
| Dimensions (W x H x D) | 24.6 mm x 82.5 mm x 53.3 mm | | | | | | |
| Housing design (light emission) | Rectangular | | | | | | |
| Sensing range max. | 0 m ... 60 m | | | | | | |
| Type of light | Infrared light | | | | | | |
| Light source | LED ¹⁾ | | | | | | |
| Light spot size (distance) | Ø 140 mm (15 m) | | | | | | |
| Wave length | 850 nm | | | | | | |
| Adjustment | <table border="0"> <tr> <td style="padding-right: 20px;">IO-Link</td> <td>For configuring the sensor parameters and Smart Task functions</td> </tr> <tr> <td>Wire/pin</td> <td>For activating the test input</td> </tr> </table> | IO-Link | For configuring the sensor parameters and Smart Task functions | Wire/pin | For activating the test input | | |
| IO-Link | For configuring the sensor parameters and Smart Task functions | | | | | | |
| Wire/pin | For activating the test input | | | | | | |
| Indication | <table border="0"> <tr> <td style="padding-right: 20px;">LED blue</td> <td>BluePilot: Alignment aid</td> </tr> <tr> <td>LED green</td> <td>Operating indicator Static: power on Flashing: IO-Link mode</td> </tr> <tr> <td>LED yellow</td> <td>Status of received light beam Static: object not present Static off: object present Flashing: Below the 1.5 function reserve</td> </tr> </table> | LED blue | BluePilot: Alignment aid | LED green | Operating indicator Static: power on Flashing: IO-Link mode | LED yellow | Status of received light beam Static: object not present Static off: object present Flashing: Below the 1.5 function reserve |
| LED blue | BluePilot: Alignment aid | | | | | | |
| LED green | Operating indicator Static: power on Flashing: IO-Link mode | | | | | | |
| LED yellow | Status of received light beam Static: object not present Static off: object present Flashing: Below the 1.5 function reserve | | | | | | |
| Pin 2 configuration | External Input (test), Teach-in, switching signal | | | | | | |

¹⁾ Average service life: 100,000 h at T_U = +25 °C.

Mechanics/electronics

| | |
|--|---|
| Supply voltage | 10 V DC ... 30 V DC ¹⁾ |
| Ripple | < 5 V _{pp} |
| Power consumption, sender | ≤ 30 mA ²⁾ < 50 mA ³⁾ |
| Power consumption, receiver | ≤ 30 mA ²⁾ < 50 mA ³⁾ |
| Switching output | Push-pull: PNP/NPN |
| Output: Q_{L1} / C | Switching output or IO-Link mode |
| Output function | Factory setting: Pin 2 / white (MF): NPN normally closed (light switching), PNP normally open (dark switching), Pin 4 / black (QL1 / C): NPN normally open (dark switching), PNP normally closed (light switching), IO-Link |
| Switching mode | Light/dark switching |
| Signal voltage PNP HIGH/LOW | Approx. V _S - 2.5 V / 0 V |
| Signal voltage NPN HIGH/LOW | Approx. V _S / < 2.5 V |
| Output current I_{max.} | ≤ 100 mA |
| Response time | ≤ 500 μs ⁴⁾ |
| Switching frequency | 1,000 Hz ⁵⁾ |
| Connection type | Male connector M12, 4-pin |
| Circuit protection | A ⁶⁾ B ⁷⁾ C ⁸⁾ D ⁹⁾ |
| Protection class | III |
| Weight | 160 g |
| Housing material | Plastic, VISTAL® |
| Optics material | Plastic, PMMA |
| Enclosure rating | IP66 (According to EN 60529) IP67 (According to EN 60529) IP69 (According to EN 60529) ¹⁰⁾ |
| Test input sender off | Test at 0 V |
| Ambient operating temperature | -40 °C ... +60 °C |
| Ambient temperature, storage | -40 °C ... +75 °C |
| UL File No. | NRKH.E181493 & NRKH7.E181493 |

- 1) Limit values.
- 2) 16 V DC ... 30 V DC, without load.
- 3) 10 V DC ... 16 V DC, without load.
- 4) Signal transit time with resistive load in switching mode. Different values possible in COM2 mode.
- 5) With light/dark ratio 1:1 in switching mode. Different values possible in IO-Link mode.
- 6) A = V_S connections reverse-polarity protected.
- 7) B = inputs and output reverse-polarity protected.
- 8) C = interference suppression.
- 9) D = outputs overcurrent and short-circuit protected.
- 10) Replaces IP69K with ISO 20653: 2013-03.

Safety-related parameters

| | |
|-------------------------|-----------|
| MTTF_D | 539 years |
| DC_{avg} | 0 % |

Communication interface

| | |
|---------------------------------------|--|
| Communication interface | IO-Link V1.1 |
| Communication Interface detail | COM2 (38,4 kBaud) |
| Cycle time | 2.3 ms |
| Process data length | 16 Bit |
| Process data structure | Bit 0 = switching signal Q _{L1} Bit 1 = switching signal Q _{L2} Bit 2 ... 15 = empty |
| VendorID | 26 |
| DeviceID HEX | 0x800188 |
| DeviceID DEC | 8389000 |

Smart Task

| | |
|----------------------------------|---|
| Smart Task name | Base logics |
| Logic function | Direct AND OR Window Hysteresis |
| Timer function | Deactivated On delay Off delay ON and OFF delay Impulse (one shot) |
| Inverter | Yes |
| Switching frequency | SIO Direct: 1000 Hz ¹⁾ SIO Logic: 800 Hz ²⁾ IOL: 650 Hz ³⁾ |
| Response time | SIO Direct: 500 μs ¹⁾ SIO Logic: 600 μs ²⁾ IOL: 750 μs ³⁾ |
| Repeatability | SIO Direct: 150 μs ¹⁾ SIO Logic: 300 μs ²⁾ IOL: 400 μs ³⁾ |
| Switching signal | |
| Switching signal Q _{L1} | Switching output |
| Switching signal Q _{L2} | Switching output |

¹⁾ SIO Direct: sensor operation in standard I/O mode without IO-Link communication and without using internal sensor logic or time parameters (set to "direct"/"deactivated").

²⁾ SIO Logic: Sensor operation in standard I/O mode without IO-Link communication. Sensor-internal logic or timing parameters plus Automation Functions used.

³⁾ IOL: Sensor operation with full IO-Link communication and usage of logic, timing and Automation Function parameters.

Diagnosis

| | |
|---------------------------|-----|
| Status information | |
| Device status | Yes |
| Quality of teach | Yes |

| Quality of run | Yes, Contamination display |
|----------------|----------------------------|
|----------------|----------------------------|

Classifications

| | |
|-----------------------|----------|
| ECI@ss 5.0 | 27270901 |
| ECI@ss 5.1.4 | 27270901 |
| ECI@ss 6.0 | 27270901 |
| ECI@ss 6.2 | 27270901 |
| ECI@ss 7.0 | 27270901 |
| ECI@ss 8.0 | 27270901 |
| ECI@ss 8.1 | 27270901 |
| ECI@ss 9.0 | 27270901 |
| ECI@ss 10.0 | 27270901 |
| ECI@ss 11.0 | 27270901 |
| ETIM 5.0 | EC002716 |
| ETIM 6.0 | EC002716 |
| ETIM 7.0 | EC002716 |
| ETIM 8.0 | EC002716 |
| UNSPSC 16.0901 | 39121528 |

Connection diagram

Cd-392

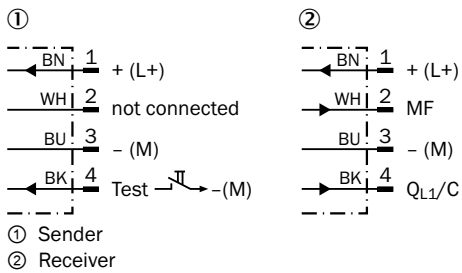

Characteristic curve

WSE26P-xxxxx1xx

Function reserve

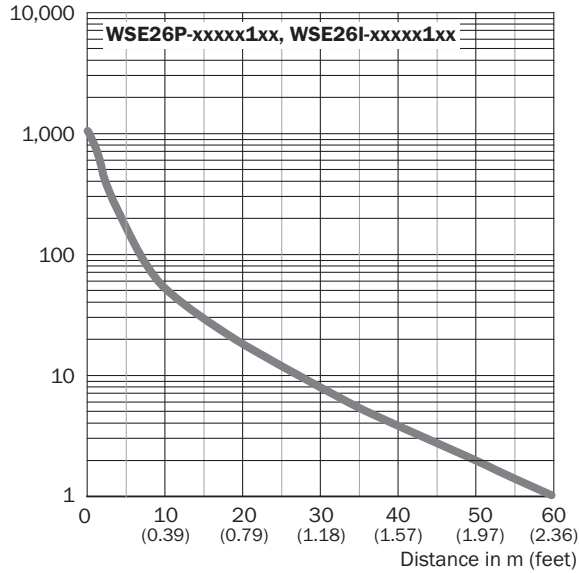

WSE26I-xxxxx1xx

Light spot size

Infrared light

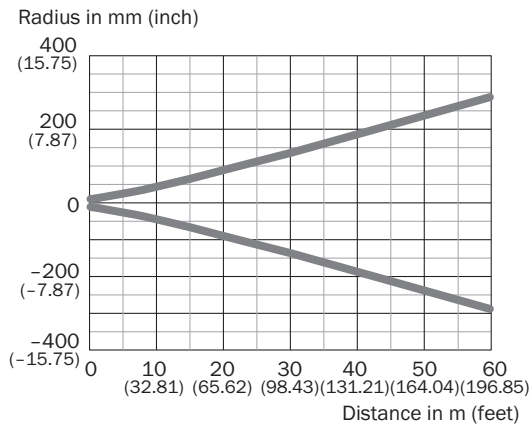

WSE26I-xxxxx1xx

Sensing range diagram

WSE26P-xxxxx1xx

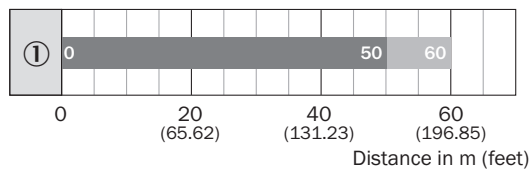

■ Sensing range ■ Sensing range typ. max.

WSE26I-xxxxx1xx

Functions

Operation note

BluePilot: Blue indicator LEDs with double benefits

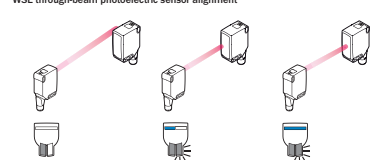
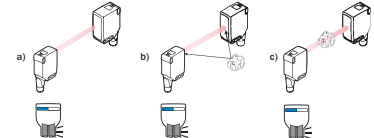
| | |
|---|--|
| <p>Easy and quick sensor alignment with the help of the LED indicator</p> <p>All blue LEDs illuminate</p> <ul style="list-style-type: none"> - optimum alignment - highest possible operating reserve | <p>WSE through-beam photoelectric sensor alignment</p>  |
| <p>Service note</p> <p>A reduction in sensor availability is displayed by a decrease of the blue LEDs.</p> <p>Possible causes:</p> <ul style="list-style-type: none"> a) insufficient alignment b) contamination of the optical surfaces c) particles in the light beam |  |

Operation note

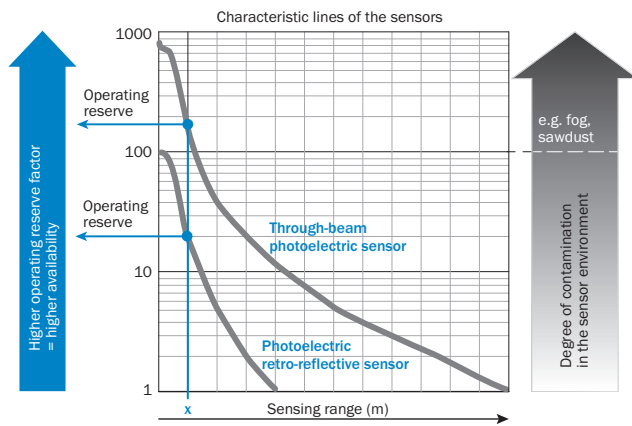

At a sensing range of „x“ the photoelectric retro-reflective and through-beam photoelectric sensors have different operating reserves (see blue arrow). The higher the operating reserve factor, the better the sensor can compensate the contamination in the air or in the light beam and on the optical surfaces (front screen, reflector), i.e. the sensor has the maximum availability, otherwise the sensor switches due to pollution although there is no object in the path of the light beam.

Adjustments

Display and adjustment elements

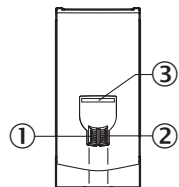

- ① LED indicator green
- ② LED indicator yellow
- ③ LED blue

Dimensional drawing (Dimensions in mm (inch))

WSE26, connector

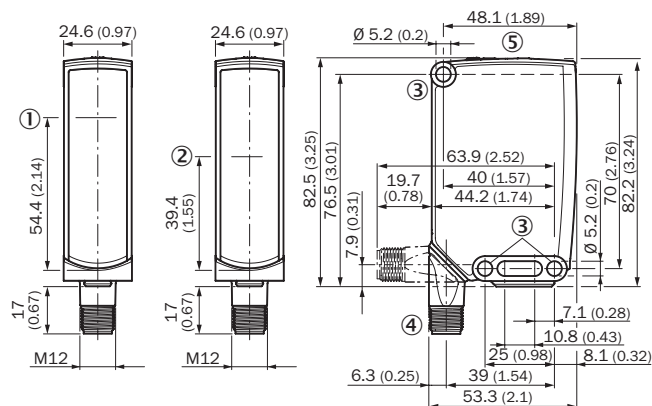

- ① Center of optical axis, sender
- ② Center of optical axis, receiver
- ③ Mounting hole, Ø 5.2 mm
- ④ Connection
- ⑤ Display and adjustment elements

Recommended accessories

Other models and accessories → www.sick.com/W26

| | Brief description | Type | Part no. |
|------------------------------------|--|--------------------|-----------------|
| Universal bar clamp systems | | | |
| | Plate N12 for universal clamp. For mounting PL30A, P250 reflectors, W27 and WTR2 sensors., Zinc plated steel (sheet), Zinc die cast (clamping bracket), Universal clamp (2022726), mounting hardware | BEF-KHS-N12 | 2071950 |
| Plug connectors and cables | | | |
| | Head A: female connector, M12, 4-pin, straight, A-coded Head B: Flying leads Cable: Sensor/actuator cable, PVC, unshielded, 5 m | YF2A14-050VB3XLEAX | 2096235 |
| | Head A: male connector, M12, 4-pin, straight Head B: - Cable: unshielded | STE-1204-G | 6009932 |

Recommended services

Additional services → www.sick.com/W26

| | Type | Part no. |
|---|------------------------|------------|
| Function Block Factory | | |
| <ul style="list-style-type: none">Description: The Function Block Factory supports common programmable logic controllers (PLCs) from various manufacturers, such as Siemens, Beckhoff, Rockwell Automation and B&R. More information on the FBF can be found <a _blank"="" href="https://fbf.cloud.sick.com target=">here. | Function Block Factory | On request |

SICK AT A GLANCE

SICK is one of the leading manufacturers of intelligent sensors and sensor solutions for industrial applications. A unique range of products and services creates the perfect basis for controlling processes securely and efficiently, protecting individuals from accidents and preventing damage to the environment.

We have extensive experience in a wide range of industries and understand their processes and requirements. With intelligent sensors, we can deliver exactly what our customers need. In application centers in Europe, Asia and North America, system solutions are tested and optimized in accordance with customer specifications. All this makes us a reliable supplier and development partner.

Comprehensive services complete our offering: SICK LifeTime Services provide support throughout the machine life cycle and ensure safety and productivity.

For us, that is “Sensor Intelligence.”

WORLDWIDE PRESENCE:

Contacts and other locations –www.sick.com