

G2-LAURA-O-P

~40° x 13° oval beam. Assembly with thinner white holder, installation tape and location pins.

TECHNICAL SPECIFICATIONS:

Dimensions	21.6 x 21.6 mm
Height	13.1 mm
Fastening	tape, pin
ROHS compliant	yes ⓘ

MATERIAL SPECIFICATIONS:

Component	Type	Material	Colour	Finish
LAURA-O	Single lens	PMMA	clear	
LAURA-LT-PIN-XP-HLD-WHT	Holder	PC	white	
ROSE-TAPE	Tape	Acrylic foam	black	

ORDERING INFORMATION:

Component		Qty in box	MOQ	MPQ	Box weight (kg)
CA13631_G2-LAURA-O-P	Single lens	1440	360	180	6.0
» Box size: 451 x 254 x 152 mm					



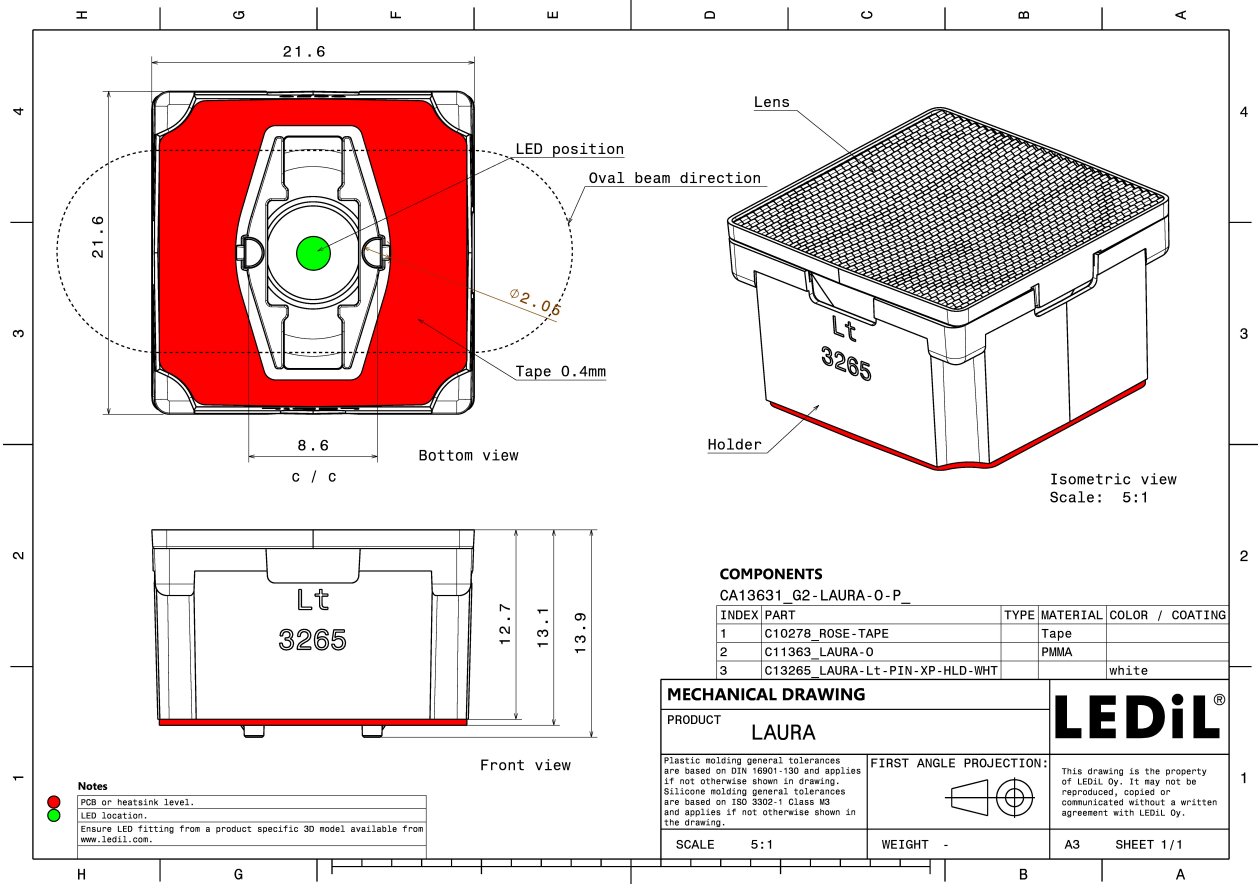

See also our general installation guide: www.ledil.com/installation_guide

PHOTOMETRIC DATA (MEASURED):

CREE LED

LED XB-D
 FWHM / FWTM 41.0 + 13.0° / 57.0 + 26.0°
 Efficiency 86 %
 Peak intensity 4.8 cd/lm
 LEDs/each optic 1
 Light colour White
 Required components:

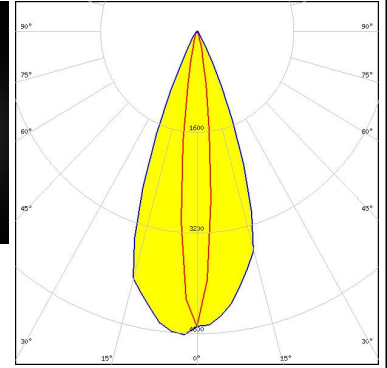
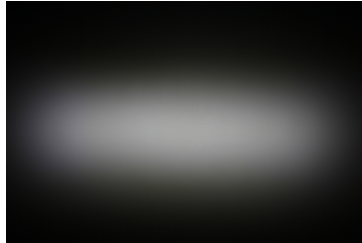

CREE LED

LED XB-H
 FWHM / FWTM 41.0 + 13.0° / 58.0 + 26.0°
 Efficiency 87 %
 Peak intensity 4.6 cd/lm
 LEDs/each optic 1
 Light colour White
 Required components:

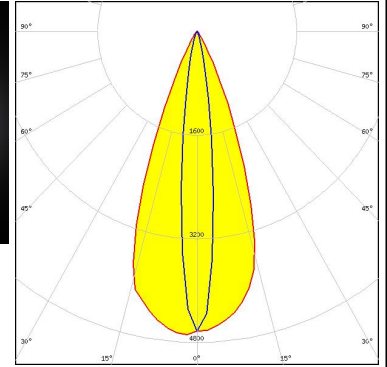
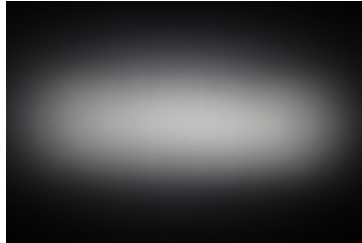

CREE LED

LED XP-E
 FWHM / FWTM 40.0 + 13.0° / 55.0 + 24.0°
 Efficiency 91 %
 Peak intensity 4.8 cd/lm
 LEDs/each optic 1
 Light colour White
 Required components:



CREE LED

LED XP-E2
 FWHM / FWTM 41.0 + 11.0° / 55.0 + 22.0°
 Efficiency 88 %
 Peak intensity 5.8 cd/lm
 LEDs/each optic 1
 Light colour White
 Required components:

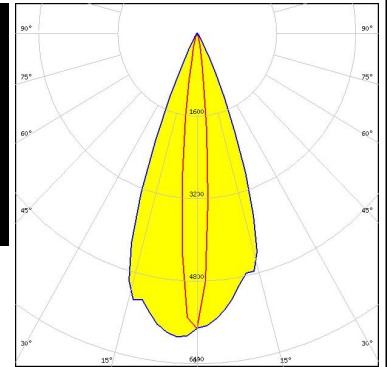
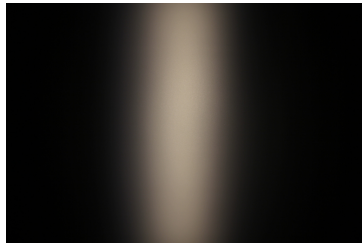

PHOTOMETRIC DATA (MEASURED):



LED XP-G2
 FWHM / FWTM 41.0 + 14.0° / 58.0 + 27.0°
 Efficiency 87 %
 Peak intensity 4.8 cd/m
 LEDs/each optic 1
 Light colour White
 Required components:

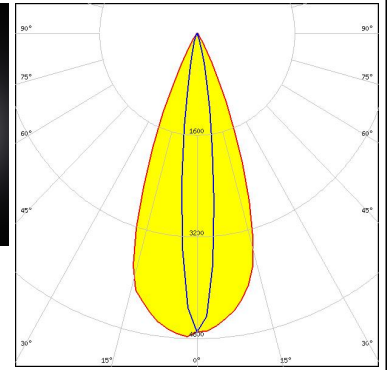
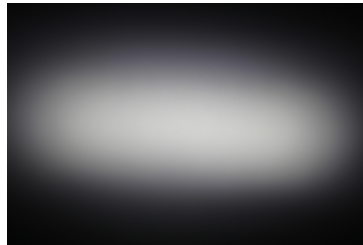

LED XP-G3
 FWHM / FWTM 39.0 + 13.0° / 58.0 + 29.0°
 Efficiency 93 %
 Peak intensity 4.3 cd/m
 LEDs/each optic 1
 Light colour White
 Required components:

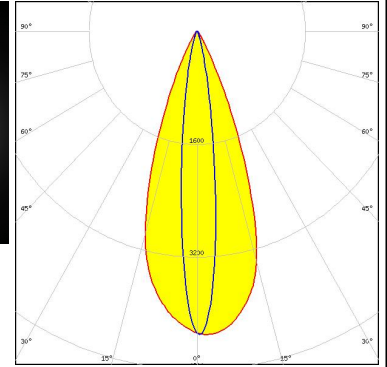

LED XP-L HD
 FWHM / FWTM 38.0 + 16.0° / 60.0 + 34.0°
 Efficiency 89 %
 Peak intensity 3.8 cd/m
 LEDs/each optic 1
 Light colour White
 Required components:

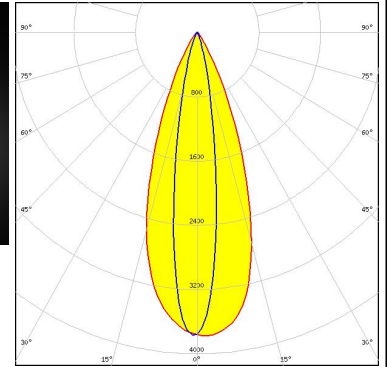
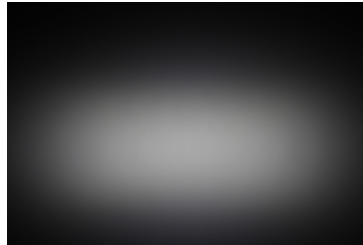

LED XP-L2
 FWHM / FWTM 38.0 + 17.0° / 64.0 + 38.0°
 Efficiency 84 %
 Peak intensity 3.1 cd/m
 LEDs/each optic 1
 Light colour White
 Required components:

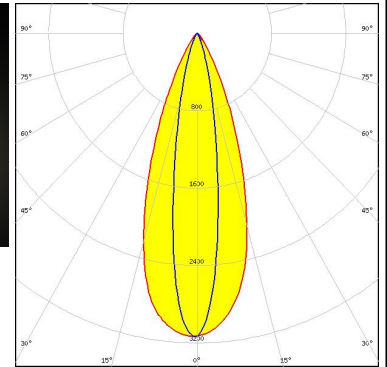
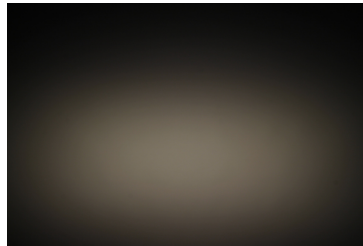

PHOTOMETRIC DATA (MEASURED):



LED XT-E
 FWHM / FWTM 40.0 + 14.0° / 59.0 + 29.0°
 Efficiency 87 %
 Peak intensity 4.4 cd/lm
 LEDs/each optic 1
 Light colour White
 Required components:

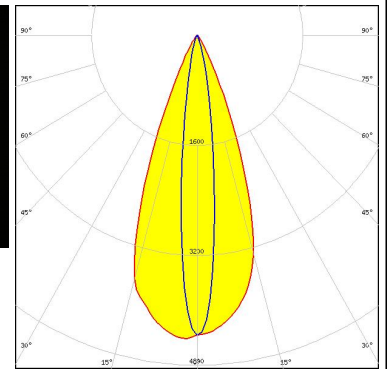
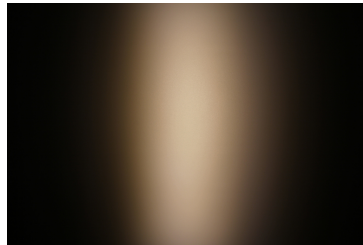

LED LUXEON 3030 2D (Round LES)
 FWHM / FWTM 40.0 + 13.0° / 58.0 + 26.0°
 Efficiency 88 %
 Peak intensity 4.7 cd/lm
 LEDs/each optic 1
 Light colour White
 Required components:

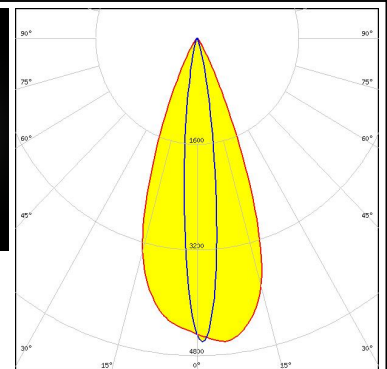
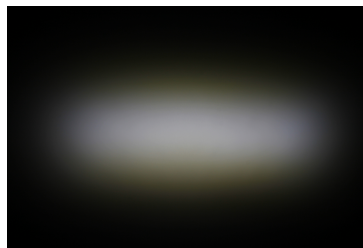



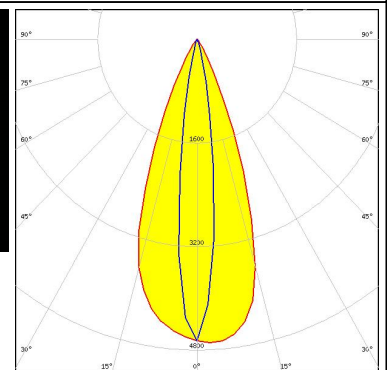

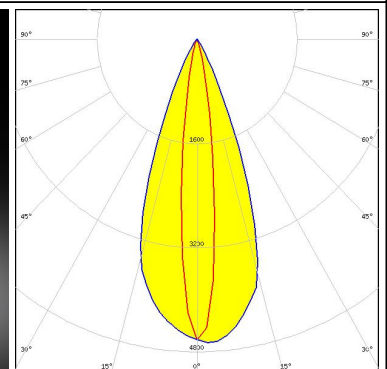

LED LUXEON T
 FWHM / FWTM 40.0 + 15.0° / 60.0 + 28.0°
 Efficiency 90 %
 Peak intensity 4.7 cd/lm
 LEDs/each optic 1
 Light colour White
 Required components:



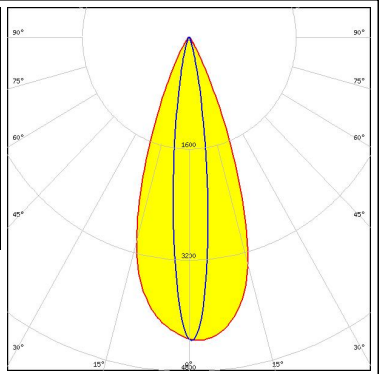

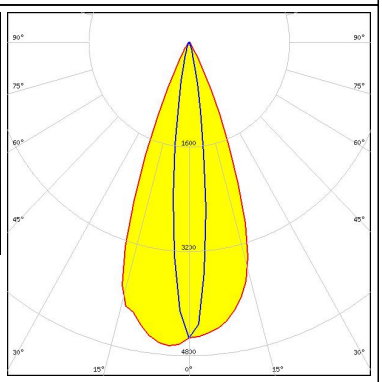

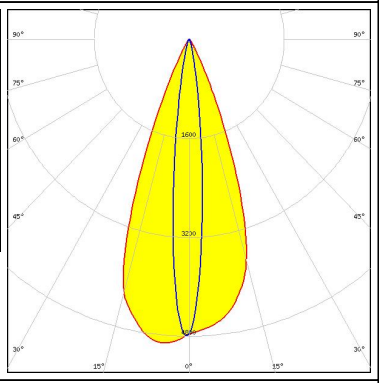

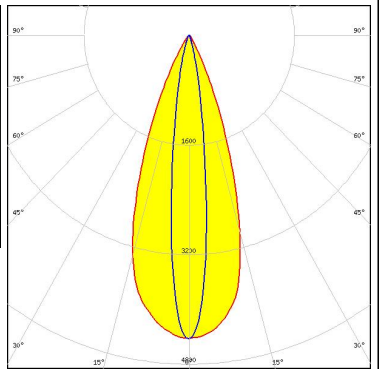
LED LUXEON TX
 FWHM / FWTM 41.0 + 14.0° / 59.0 + 27.0°
 Efficiency 87 %
 Peak intensity 4.6 cd/lm
 LEDs/each optic 1
 Light colour White
 Required components:

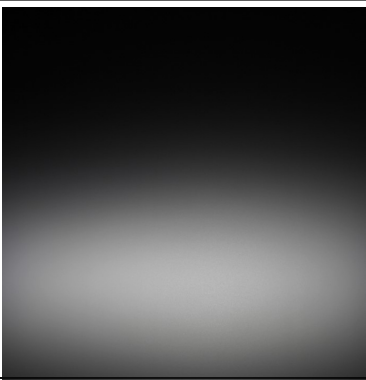
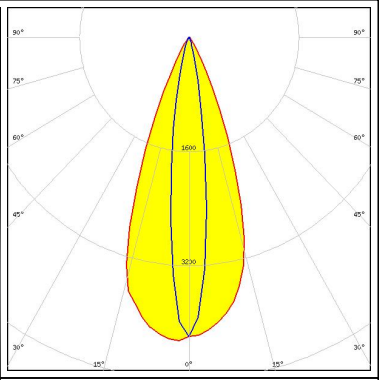

PHOTOMETRIC DATA (MEASURED):

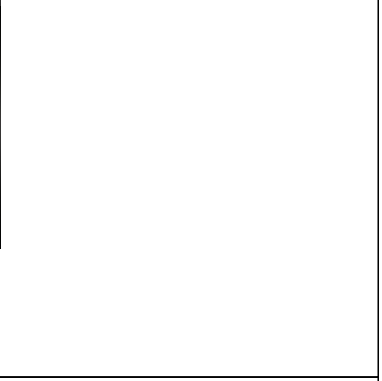
<p>LUMILEDS</p> <p>LED LUXEON V2</p> <p>FWHM / FWTM 39.0 + 13.0° / 58.0 + 29.0°</p> <p>Efficiency 93 %</p> <p>Peak intensity 4.4 cd/lm</p> <p>LEDs/each optic 1</p> <p>Light colour White</p> <p>Required components:</p>		
<p>NICHIA</p> <p>LED NCSxx19A</p> <p>FWHM / FWTM 41.0 + 13.0° / 58.0 + 27.0°</p> <p>Efficiency 87 %</p> <p>Peak intensity 4.7 cd/lm</p> <p>LEDs/each optic 1</p> <p>Light colour White</p> <p>Required components:</p>		
<p>NICHIA</p> <p>LED NCSxx19B</p> <p>FWHM / FWTM 40.0 + 12.0° / 56.0 + 24.0°</p> <p>Efficiency 87 %</p> <p>Peak intensity 4.9 cd/lm</p> <p>LEDs/each optic 1</p> <p>Light colour White</p> <p>Required components:</p>		
<p>NICHIA</p> <p>LED NVSW219D</p> <p>FWHM / FWTM 38.0 + 14.0° / 59.0 + 29.0°</p> <p>Efficiency 94 %</p> <p>Peak intensity 4.4 cd/lm</p> <p>LEDs/each optic 1</p> <p>Light colour White</p> <p>Required components:</p>		

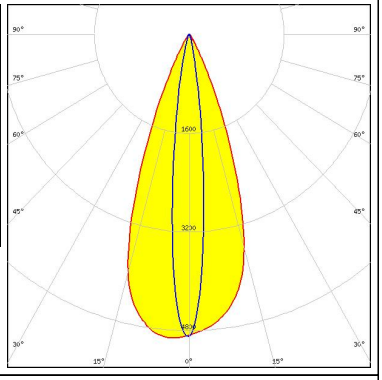
PHOTOMETRIC DATA (MEASURED):

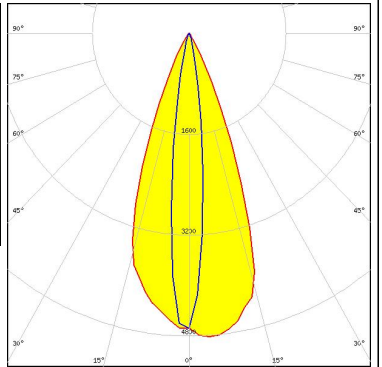
<p>NICHIA</p> <p>LED NVSxx19A FWHM / FWTM 40.0 + 15.0° / 60.0 + 30.0° Efficiency 87 % Peak intensity 4.3 cd/lm LEDs/each optic 1 Light colour White Required components:</p>		
<p>NICHIA</p> <p>LED NVSxx19B/NVSxx19C FWHM / FWTM 37.0 + 12.0° / 62.0 + 28.0° Efficiency 89 % Peak intensity 5.3 cd/lm LEDs/each optic 1 Light colour White Required components:</p>		
<p>OSRAM <small>Opto Semiconductors</small></p> <p>LED OSLOM Square CSSRM2/CSSRM3 FWHM / FWTM 39.0 + 12.0° / 57.0 + 25.0° Efficiency 94 % Peak intensity 4.9 cd/lm LEDs/each optic 1 Light colour White Required components:</p>		
<p>OSRAM <small>Opto Semiconductors</small></p> <p>LED OSLOM Square EC FWHM / FWTM 40.0 + 13.0° / 58.0 + 27.0° Efficiency 87 % Peak intensity 4.8 cd/lm LEDs/each optic 1 Light colour White Required components:</p>		

PHOTOMETRIC DATA (MEASURED):

SAMSUNG

LED LH351D
 FWHM / FWTM 37.0 + 17.0° / 63.0 + 34.0°
 Efficiency 92 %
 Peak intensity 3.6 cd/lm
 LEDs/each optic 1
 Light colour White
 Required components:

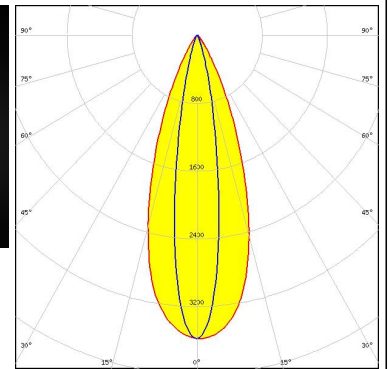

SEOUL SEMICONDUCTOR

LED Z5M1/Z5M2
 FWHM / FWTM 40.0 + 12.0° / 57.0 + 26.0°
 Efficiency 86 %
 Peak intensity 4.6 cd/lm
 LEDs/each optic 1
 Light colour White
 Required components:

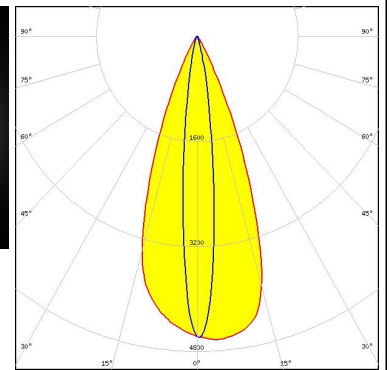
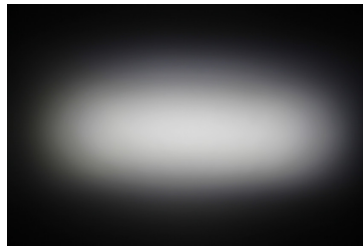

SEOUL SEMICONDUCTOR

LED Z5M3
 FWHM / FWTM 39.0 + 15.0° / 60.0 + 32.0°
 Efficiency 94 %
 Peak intensity 4 cd/lm
 LEDs/each optic 1
 Light colour White
 Required components:

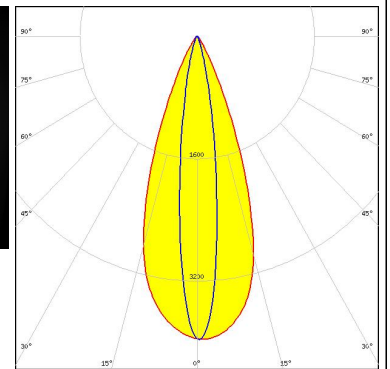

PHOTOMETRIC DATA (SIMULATED):



LED XQ-E HD
 FWHM / FWTM 66.0 + 9.0° / 89.0 + 18.0°
 Efficiency 94 %
 Peak intensity 4 cd/lm
 LEDs/each optic 1
 Light colour White
 Required components:

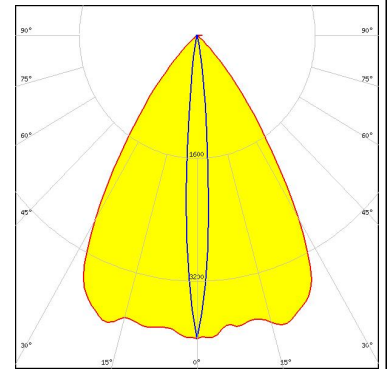

LED LUXEON 3535L
 FWHM / FWTM 62.0 + 10.0° / 84.0 + 23.0°
 Efficiency 91 %
 Peak intensity 3.2 cd/lm
 LEDs/each optic 1
 Light colour White
 Required components:

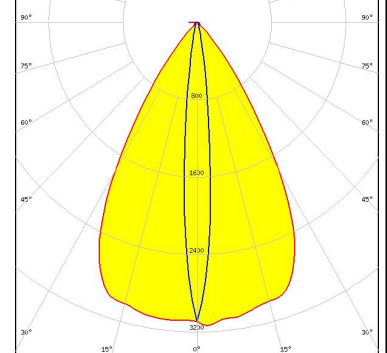

LED OSCONIQ C 2424
 FWHM / FWTM 61.0 + 12.0° / 82.0 + 24.0°
 Efficiency 90 %
 Peak intensity 3 cd/lm
 LEDs/each optic 1
 Light colour White
 Required components:

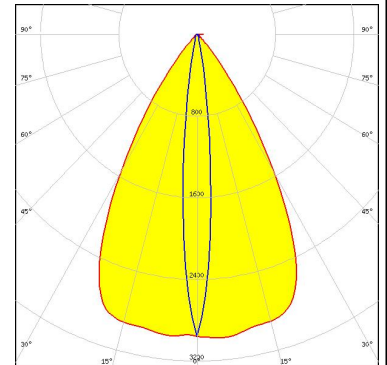

LED OSCONIQ P 3030
 FWHM / FWTM 66.0 + 10.0° / 85.0 + 19.0°
 Efficiency 91 %
 Peak intensity 3.7 cd/lm
 LEDs/each optic 1
 Light colour White
 Required components:

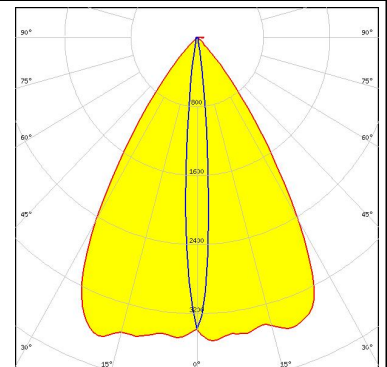

PHOTOMETRIC DATA (SIMULATED):

OSRAM

Opto Semiconductors

LED OSLOM Black
 FWHM / FWTM 62.0 + 10.0° / 83.0 + 20.0°
 Efficiency %
 Peak intensity 3.2 cd/lm
 LEDs/each optic 1
 Light colour White
 Required components:

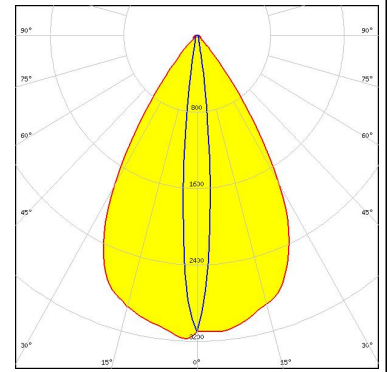

OSRAM

Opto Semiconductors

LED OSLOM Signal
 FWHM / FWTM 62.0 + 8.0° / 82.0 + 18.0°
 Efficiency 90 %
 Peak intensity 3.9 cd/lm
 LEDs/each optic 1
 Light colour Red
 Required components:

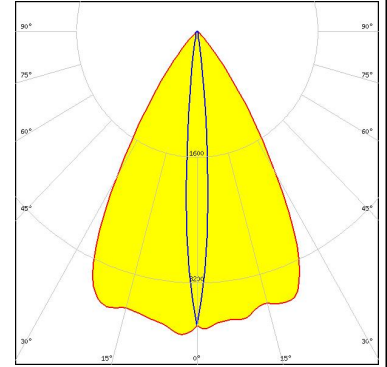

OSRAM

Opto Semiconductors

LED OSLOM Square Flat
 FWHM / FWTM 61.0 + 10.0° / 82.0 + 23.0°
 Efficiency 89 %
 Peak intensity 3.1 cd/lm
 LEDs/each optic 1
 Light colour White
 Required components:

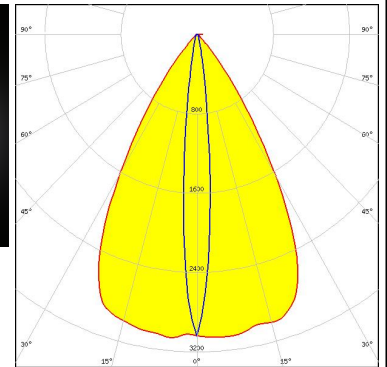
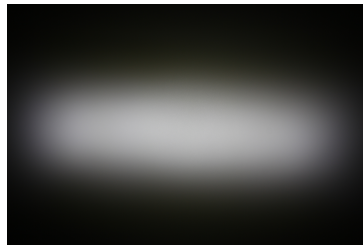

OSRAM

Opto Semiconductors

LED OSLOM SSL 150
 FWHM / FWTM 62.0 + 10.0° / 83.0 + 20.0°
 Efficiency 91 %
 Peak intensity 3.5 cd/lm
 LEDs/each optic 1
 Light colour White
 Required components:

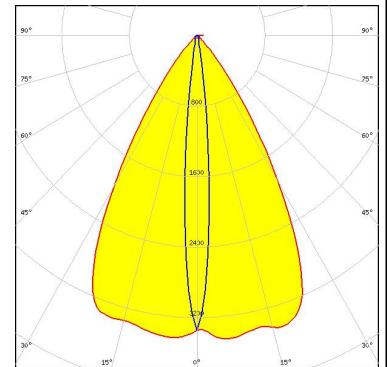

PHOTOMETRIC DATA (SIMULATED):

OSRAM

Opto Semiconductors

LED OSLO[™] SSL 80
FWHM / FW_{TM} 62.0 + 10.0° / 84.0 + 24.0°
Efficiency 90 %
Peak intensity 3.2 cd/lm
LEDs/each optic 1
Light colour White
Required components:

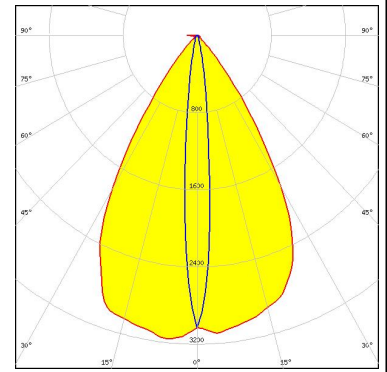

OSRAM

Opto Semiconductors

LED SFH 4770S
FWHM / FW_{TM} 63.0 + 11.0° / 83.0 + 27.0°
Efficiency 88 %
LEDs/each optic 1
Light colour White
Required components:

SEOL

SEOL SEMICONDUCTOR

LED Z8Y22P
FWHM / FW_{TM} 60.0 + 12.0° / 84.0 + 30.0°
Efficiency 93 %
Peak intensity 2.7 cd/lm
LEDs/each optic 1
Light colour White
Required components:

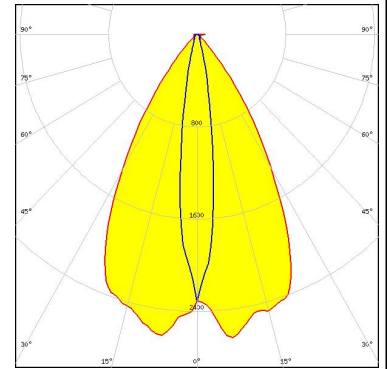

GENERAL INFORMATION:

NOTE: The typical beam angle will be changed by different color, chip size and chip position tolerance. The typical total beam angle is the full angle measured where the luminous intensity is half of the peak value.

MATERIALS:

As part of our continuous research and improvement processes, and to ensure the best possible quality and availability of our products, LEDiL reserves the right to change material grades without notice.

PRODUCT DATA USER AGREEMENT AND DISCLAIMER:

The measured data in the provided downloadable LEDiL Product Datasheets and Mechanical 2D-Drawings is rounded and provided as reference for planning. LEDiL Oy's optical specifications have been verified by conducting performance testing of the products in accordance with the company's quality system. The reported data are averaged results of multiple measurements with typical variation. LEDiL Oy reserves the right to without prior notification make changes and improvements to its products.

LEDiL Oy assumes neither warranty, nor guarantee nor any other liability of any kind for the contents and correctness of the provided data. The provided data has been generated with highest diligence but the provided data may in reality not represent the complete possible variation range of all intrinsic parameters. Therefore, in certain cases a deviation from the provided data could occur.

LEDiL Oy reserves the right to undertake technical changes of its products without further notification which could lead to changes in the provided data. LEDiL Oy assumes no liability of any kind for the possible deviation from any provided data or any other damage resulting from the usage of the provided data.

The user agrees to this disclaimer and user agreement with the download or usage of the provided files.

LEDiL Oy

Joensuunkatu 13
FI-24240 SALO
Finland

LEDiL Inc.

228 West Page Street
Suite D
Sycamore IL 60178
USA

Ledil Optics Technology (Shenzhen) Co., Ltd.

405 , Block B
Casic Motor Building
Shenzhen 518057
P.R.CHINA

Local sales and technical support

[www.ledil.com/
where_to_buy](http://www.ledil.com/where_to_buy)

Shipping locations

Salo, Finland
Hong Kong, China

Distribution Partners

[www.ledil.com/
where_to_buy](http://www.ledil.com/where_to_buy)