

MIRELLA-XW-PF

~80° wide beam

TECHNICAL SPECIFICATIONS:

Dimensions	Ø 50.0 mm
Height	23.9 mm
Fastening	socket
ROHS compliant	yes ⓘ

MATERIAL SPECIFICATIONS:

Component	Type	Material	Colour	Finish	Coating
MIRELLA-XW-PF	Reflector	HRPC	white		







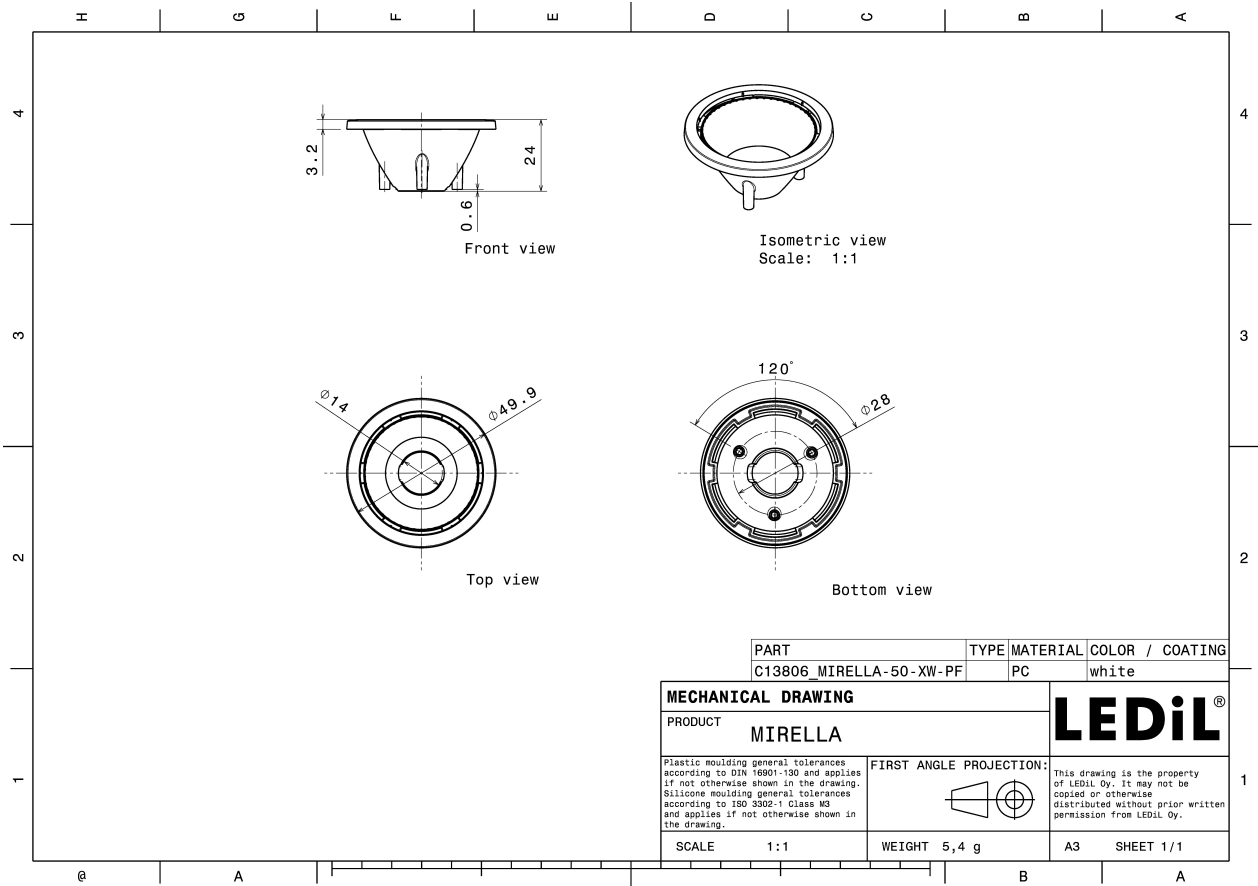

ORDERING INFORMATION:

Component	Qty in box	MOQ	MPQ	Box weight (kg)
C13806_MIRELLA-XW-PF » Box size: 480 x 280 x 300 mm	336	112	28	3.3

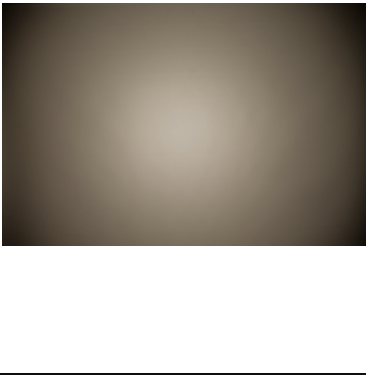
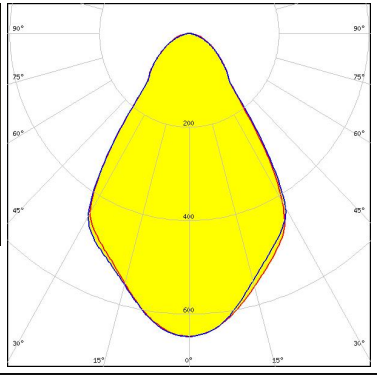

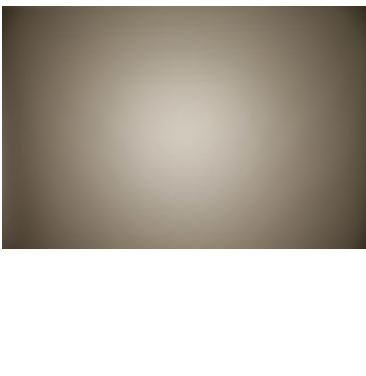
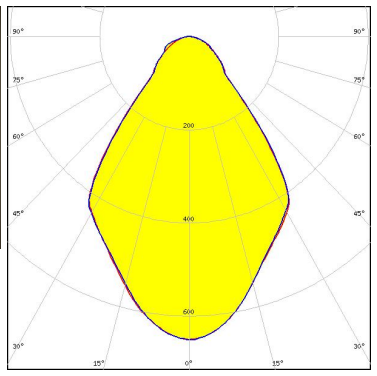

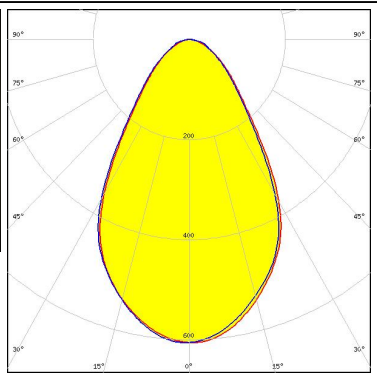
See also our general installation guide: www.ledil.com/installation_guide

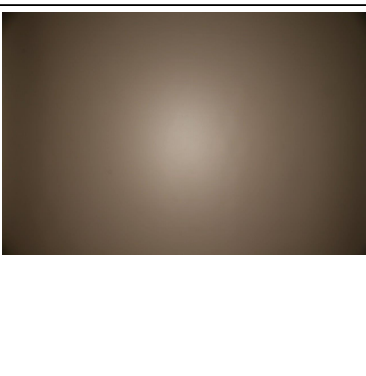
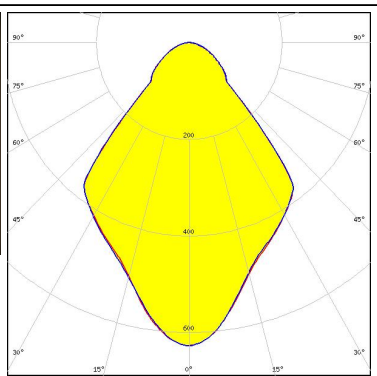

PHOTOMETRIC DATA (MEASURED):

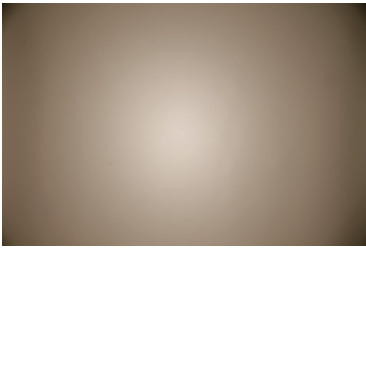
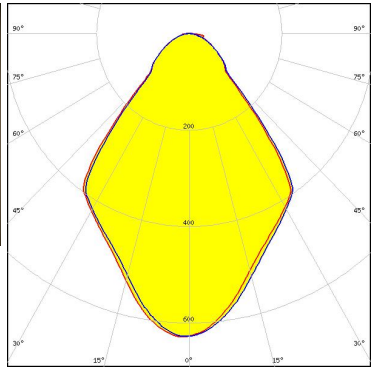
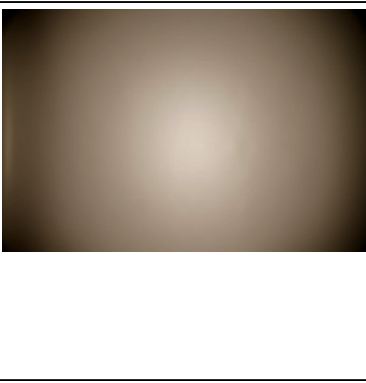
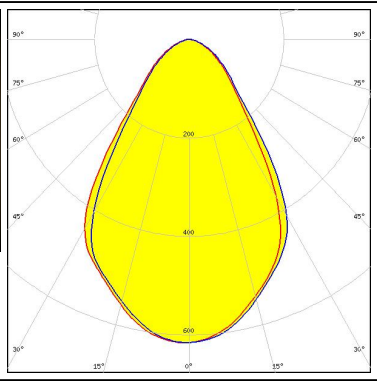
<p></p> <p>LED V10 Gen7 FWHM / FWTM 68.0° / 118.0° Efficiency 87 % Peak intensity 0.7 cd/lm LEDs/each optic 1 Light colour White</p> <p>Required components: C13709_PF-SOCKET-VERO13-18 C13333_MIRELLA-CL Bender Wirth: 486 Typ L1</p>		
<p></p> <p>LED V10 Gen7 FWHM / FWTM 73.0° / 118.0° Efficiency 91 % Peak intensity 0.7 cd/lm LEDs/each optic 1 Light colour White</p> <p>Required components: C13709_PF-SOCKET-VERO13-18 Bender Wirth: 486 Typ L1</p>		
<p></p> <p>LED V10 Gen7 FWHM / FWTM 66.0° / 120.0° Efficiency 84 % Peak intensity 0.6 cd/lm LEDs/each optic 1 Light colour White</p> <p>Required components: C13709_PF-SOCKET-VERO13-18 C12479_MIRELLA-DL</p>		
<p></p> <p>LED V6 Gen6 FWHM / FWTM 79.0° / 122.0° Efficiency 91 % Peak intensity 0.6 cd/lm LEDs/each optic 1 Light colour White</p> <p>Required components: C13761_PF-SOCKET-CXA15</p>		

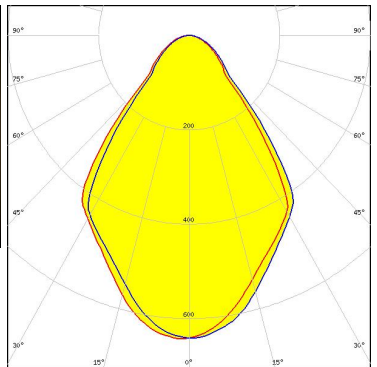

PHOTOMETRIC DATA (MEASURED):

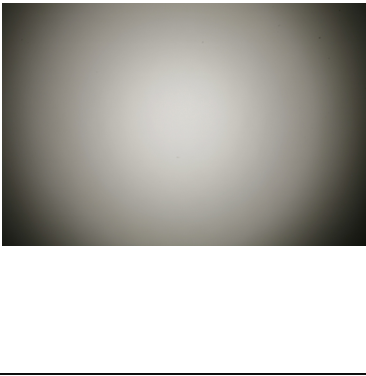
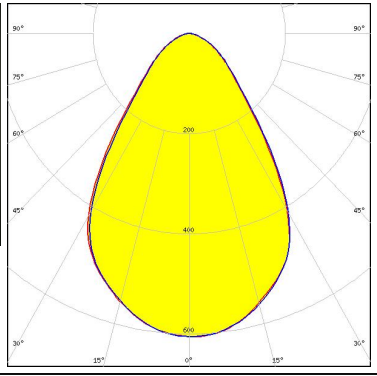
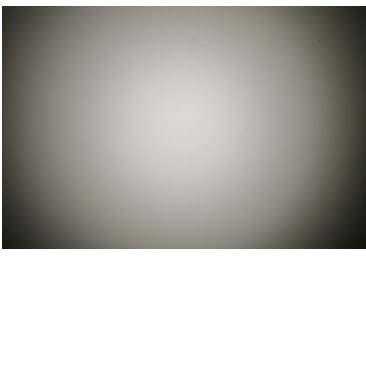
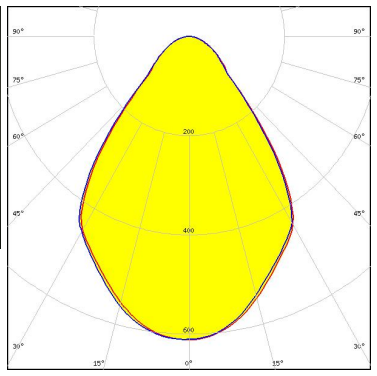
<p>bridgelux.</p> <p>LED V8 Gen6</p> <p>FWHM / FWTM 77.0° / 121.0°</p> <p>Efficiency 91 %</p> <p>Peak intensity 0.6 cd/m</p> <p>LEDs/each optic 1</p> <p>Light colour White</p> <p>Required components: C13761_PF-SOCKET-CXA15</p>		
<p>bridgelux.</p> <p>LED VERO10</p> <p>FWHM / FWTM 69.0° / 120.0°</p> <p>Efficiency 87 %</p> <p>Peak intensity 0.6 cd/m</p> <p>LEDs/each optic 1</p> <p>Light colour White</p> <p>Required components: C13708_PF-SOCKET-VERO10 C13333_MIRELLA-CL</p>		
<p>bridgelux.</p> <p>LED VERO10</p> <p>FWHM / FWTM 69.0° / 120.0°</p> <p>Efficiency 87 %</p> <p>Peak intensity 0.6 cd/m</p> <p>LEDs/each optic 1</p> <p>Light colour White</p> <p>Required components: C13708_PF-SOCKET-VERO10 C12479_MIRELLA-DL</p>		
<p>bridgelux.</p> <p>LED VERO10</p> <p>FWHM / FWTM 74.0° / 119.0°</p> <p>Efficiency 92 %</p> <p>Peak intensity 0.6 cd/m</p> <p>LEDs/each optic 1</p> <p>Light colour White</p> <p>Required components: C13708_PF-SOCKET-VERO10</p>		

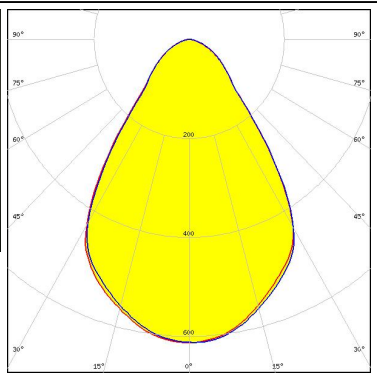
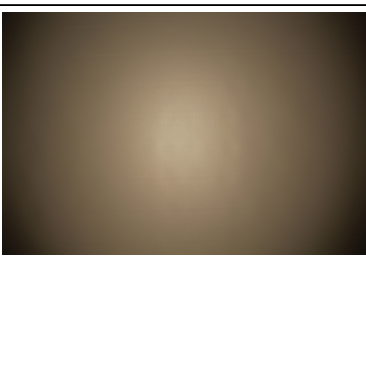
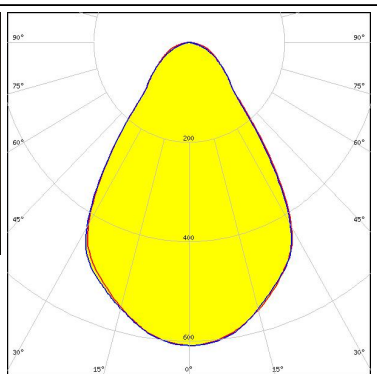
PHOTOMETRIC DATA (MEASURED):

<p>bridgelux.</p> <p>LED VERO13 FWHM / FWTM 70.0° / 121.0° Efficiency 87 % Peak intensity 0.6 cd/m LEDs/each optic 1 Light colour White</p> <p>Required components: C13709_PF-SOCKET-VERO13-18 C12479_MIRELLA-DL</p>		
<p>bridgelux.</p> <p>LED VERO13 FWHM / FWTM 75.0° / 121.0° Efficiency 92 % Peak intensity 0.6 cd/m LEDs/each optic 1 Light colour White</p> <p>Required components: C13709_PF-SOCKET-VERO13-18</p>		
<p>bridgelux.</p> <p>LED VERO13 FWHM / FWTM 71.0° / 121.0° Efficiency 87 % Peak intensity 0.6 cd/m LEDs/each optic 1 Light colour White</p> <p>Required components: C13709_PF-SOCKET-VERO13-18 C13333_MIRELLA-CL</p>		
<p>bridgelux.</p> <p>LED Xenio Point 13mm FWHM / FWTM 71.0° / 123.0° Efficiency 89 % Peak intensity 0.6 cd/m LEDs/each optic 1 Light colour White</p> <p>Required components: C13709_PF-SOCKET-VERO13-18 C13333_MIRELLA-CL</p>		

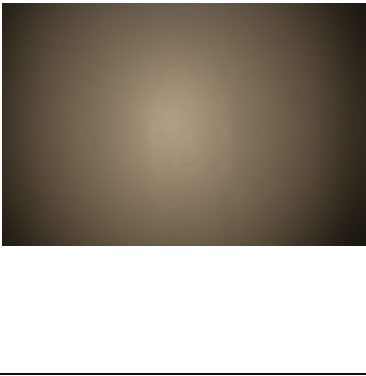
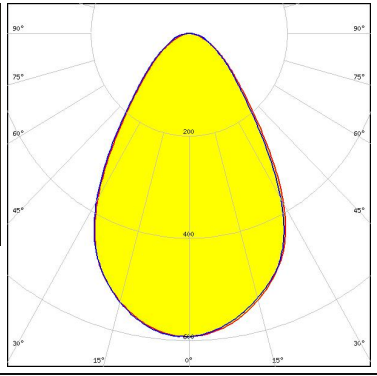
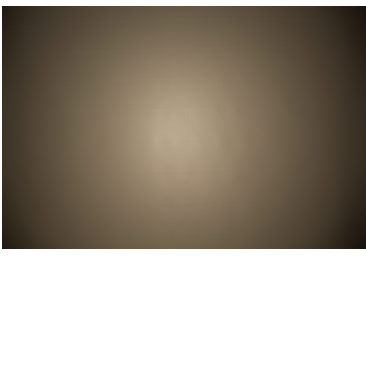
PHOTOMETRIC DATA (MEASURED):

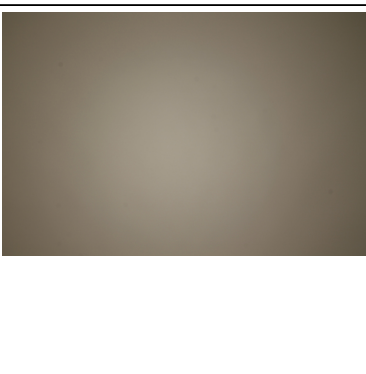
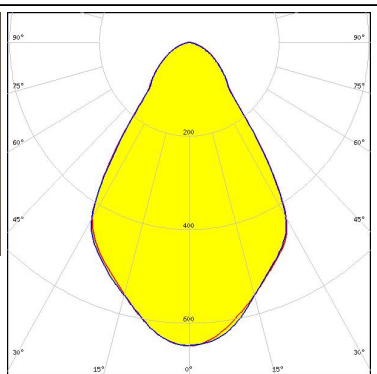
<p>bridgelux.</p> <p>LED Xenio Point 13mm FWHM / FWTM 68.0° / 122.0° Efficiency 86 % Peak intensity 0.6 cd/lm LEDs/each optic 1 Light colour White</p> <p>Required components: C13709_PF-SOCKET-VERO13-18 C12479_MIRELLA-DL</p>		
<p>bridgelux.</p> <p>LED Xenio Point 13mm FWHM / FWTM 75.0° / 122.0° Efficiency 93 % Peak intensity 0.6 cd/lm LEDs/each optic 1 Light colour White</p> <p>Required components: C13709_PF-SOCKET-VERO13-18</p>		
<p>CITIZEN</p> <p>LED CLL01x FWHM / FWTM 78.0° / 124.0° Efficiency 91 % Peak intensity 0.7 cd/lm LEDs/each optic 1 Light colour White</p> <p>Required components: C13083_PF-SOCKET</p>		
<p>CITIZEN</p> <p>LED CLL02x/CLU02x (LES10) FWHM / FWTM 68.0° / 117.0° Efficiency 85 % Peak intensity 0.7 cd/lm LEDs/each optic 1 Light colour White</p> <p>Required components: C13709_PF-SOCKET-VERO13-18 C13333_MIRELLA-CL Bender Wirth: 434 Typ L1</p>		

PHOTOMETRIC DATA (MEASURED):

CITIZEN

LED CLL02x/CLU02x (LES10)
 FWHM / FWTM 67.0° / 117.0°
 Efficiency 80 %
 Peak intensity 0.6 cd/lm
 LEDs/each optic 1
 Light colour White
 Required components:
 C13709_PF-SOCKET-VERO13-18
 C12479_MIRELLA-DL
 Bender Wirth: 434 Typ L1

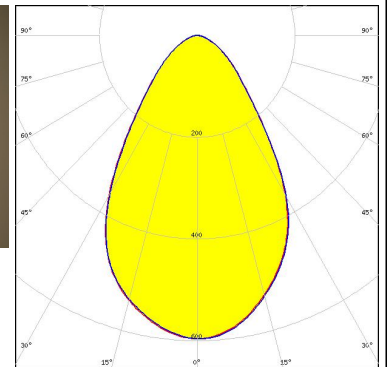

CITIZEN

LED CLL02x/CLU02x (LES10)
 FWHM / FWTM 73.0° / 116.0°
 Efficiency 89 %
 Peak intensity 0.7 cd/lm
 LEDs/each optic 1
 Light colour White
 Required components:
 C13709_PF-SOCKET-VERO13-18
 Bender Wirth: 434 Typ L1

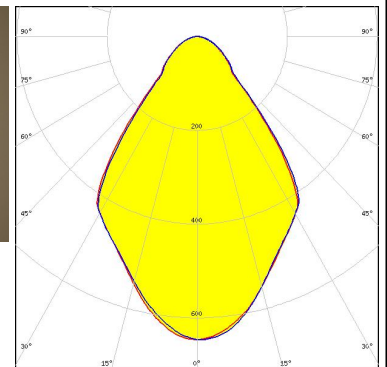

CITIZEN

LED CLU700/701/702
 FWHM / FWTM 73.0° / 113.0°
 Efficiency 89 %
 Peak intensity 0.7 cd/lm
 LEDs/each optic 1
 Light colour White
 Required components:
 C13709_PF-SOCKET-VERO13-18
 Bender Wirth: 434 Typ L1

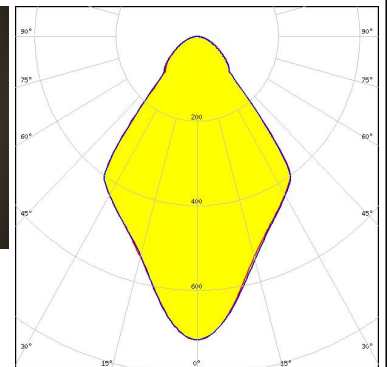
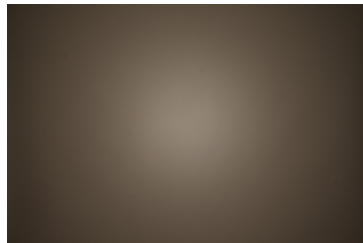

CITIZEN

LED CLU700/701/702
 FWHM / FWTM 68.0° / 114.0°
 Efficiency 86 %
 Peak intensity 0.7 cd/lm
 LEDs/each optic 1
 Light colour White
 Required components:
 C13709_PF-SOCKET-VERO13-18
 C13333_MIRELLA-CL
 Bender Wirth: 434 Typ L1

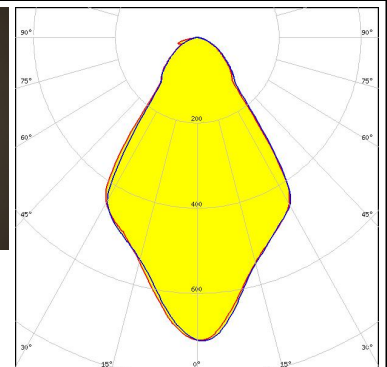
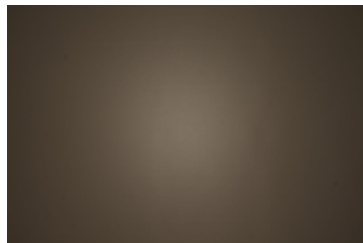

PHOTOMETRIC DATA (MEASURED):

CITIZEN

LED CLU700/701/702
 FWHM / FWTM 65.0° / 115.0°
 Efficiency 83 %
 Peak intensity 0.7 cd/lm
 LEDs/each optic 1
 Light colour White
 Required components:
 C13709_PF-SOCKET-VERO13-18
 C12479_MIRELLA-DL
 Bender Wirth: 434 Typ L1

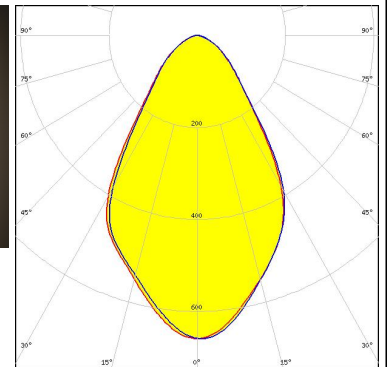
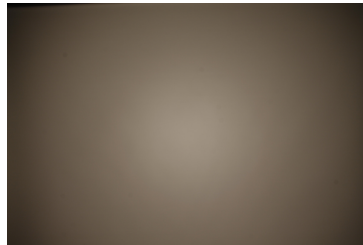

CITIZEN

LED CLU700/701/702
 FWHM / FWTM 76.0° / 117.0°
 Efficiency 92 %
 Peak intensity 0.7 cd/lm
 LEDs/each optic 1
 Light colour White
 Required components:
 C13083_PF-SOCKET

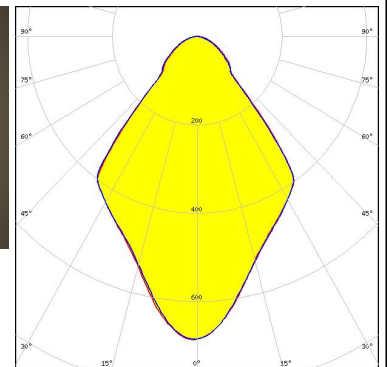
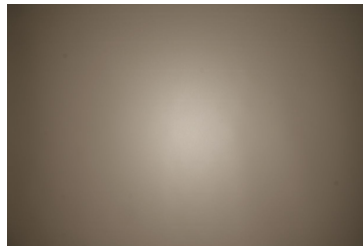

CITIZEN

LED CLU720/721
 FWHM / FWTM 73.0° / 117.0°
 Efficiency 87 %
 Peak intensity 0.6 cd/lm
 LEDs/each optic 1
 Light colour White
 Required components:
 C13709_PF-SOCKET-VERO13-18
 Bender Wirth: 433 Typ L1

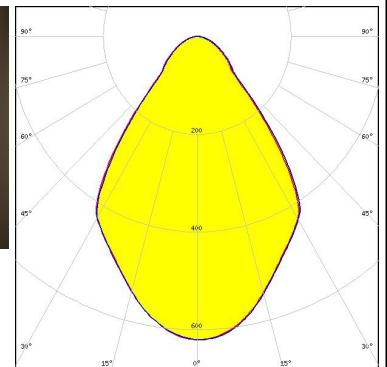
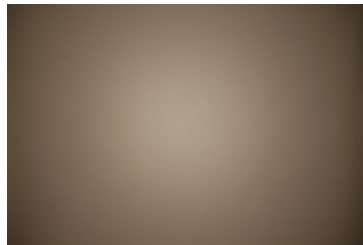

CITIZEN

LED CLU720/721
 FWHM / FWTM 68.0° / 117.0°
 Efficiency 83 %
 Peak intensity 0.6 cd/lm
 LEDs/each optic 1
 Light colour White
 Required components:
 C13709_PF-SOCKET-VERO13-18
 C13333_MIRELLA-CL
 Bender Wirth: 433 Typ L1

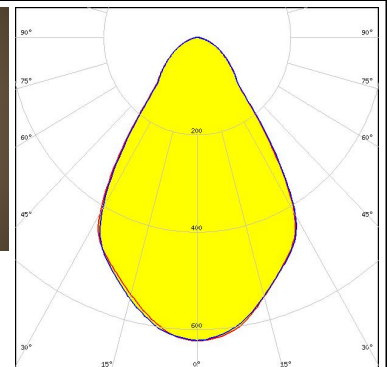
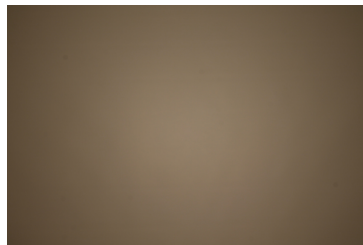

PHOTOMETRIC DATA (MEASURED):

CITIZEN

LED CLU720/721
 FWHM / FWTM 66.0° / 118.0°
 Efficiency 79 %
 Peak intensity 0.6 cd/lm
 LEDs/each optic 1
 Light colour White

Required components:

C13709_PF-SOCKET-VERO13-18
 C12479_MIRELLA-DL
 Bender Wirth: 433 Typ L1

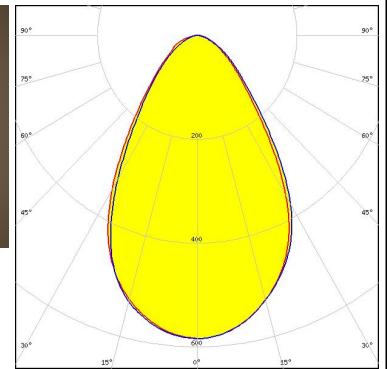
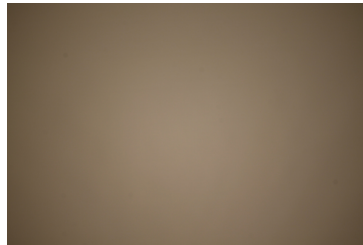

LED CXA/B 15xx
 FWHM / FWTM 73.0° / 116.0°
 Efficiency 89 %
 Peak intensity 0.7 cd/lm
 LEDs/each optic 1
 Light colour White

Required components:

C13709_PF-SOCKET-VERO13-18
 Bender Wirth: 441 Typ L1

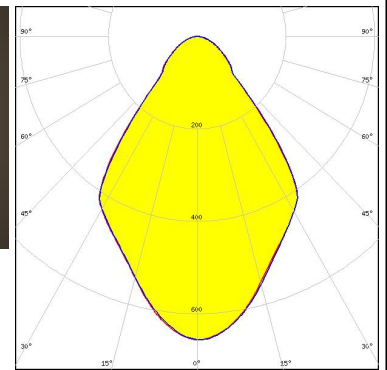
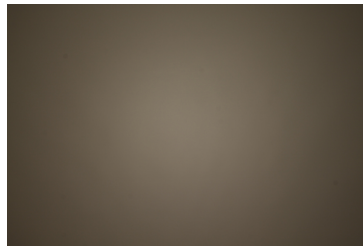

LED CXA/B 15xx
 FWHM / FWTM 68.0° / 117.0°
 Efficiency 86 %
 Peak intensity 0.7 cd/lm
 LEDs/each optic 1
 Light colour White

Required components:

C13709_PF-SOCKET-VERO13-18
 C13333_MIRELLA-CL
 Bender Wirth: 441 Typ L1

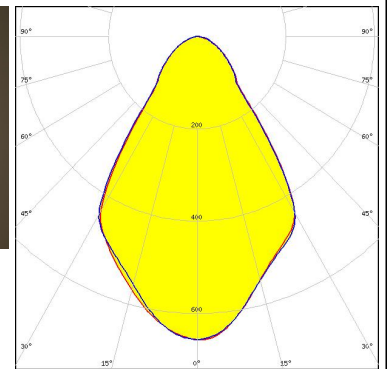
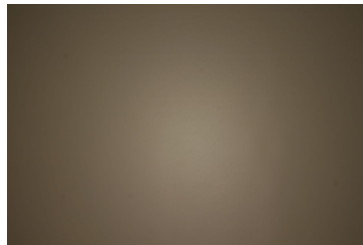



LED CXA/B 15xx
 FWHM / FWTM 66.0° / 117.0°
 Efficiency 81 %
 Peak intensity 0.6 cd/lm
 LEDs/each optic 1
 Light colour White

Required components:

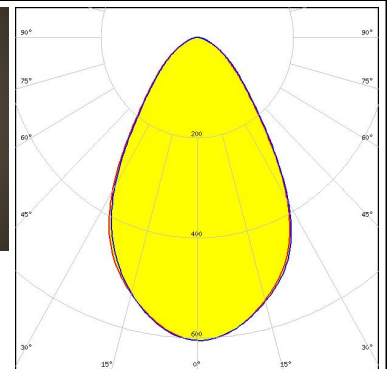
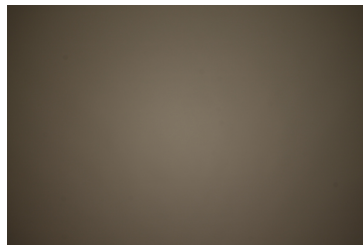

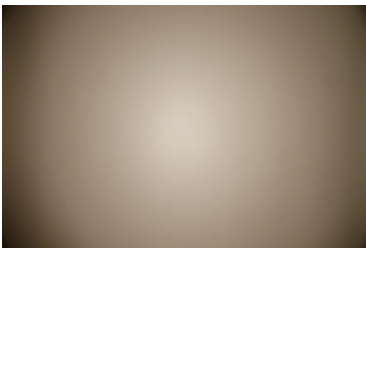
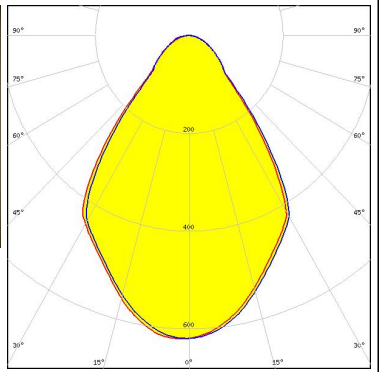
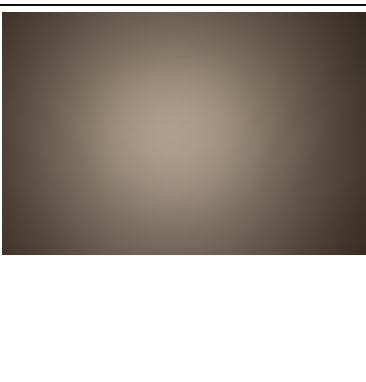
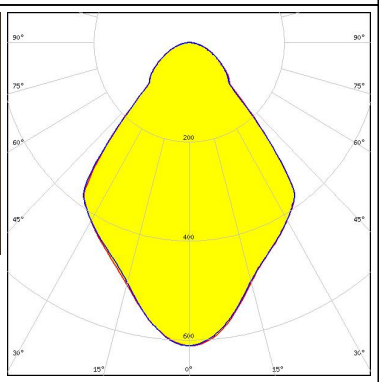

C13709_PF-SOCKET-VERO13-18
 C12479_MIRELLA-DL
 Bender Wirth: 441 Typ L1

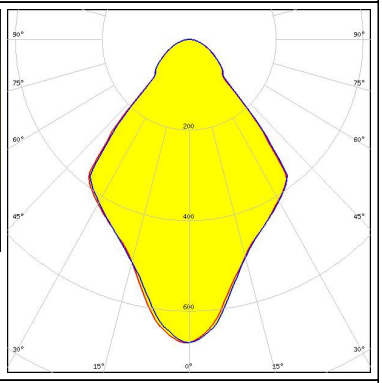
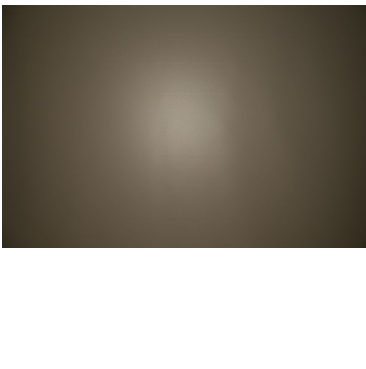
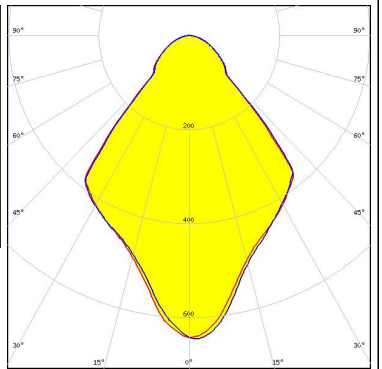



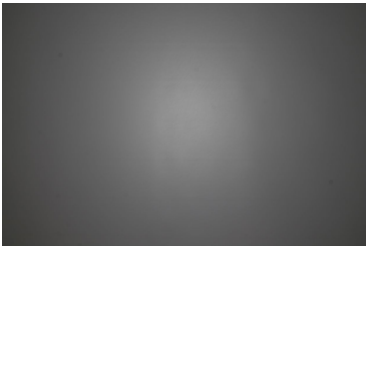
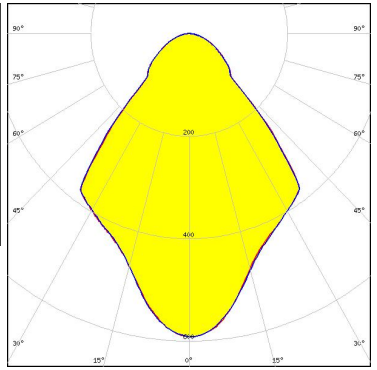

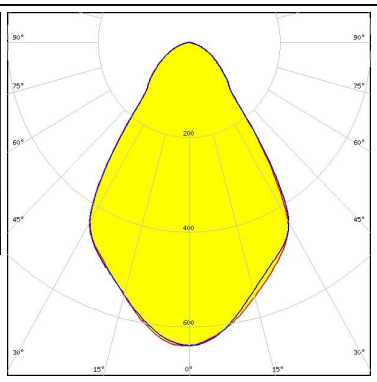
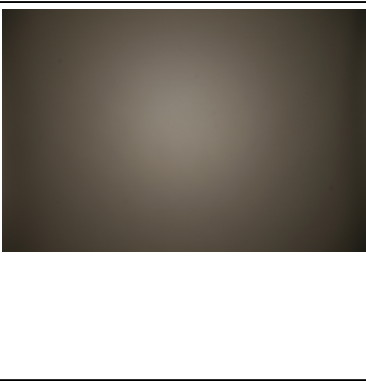
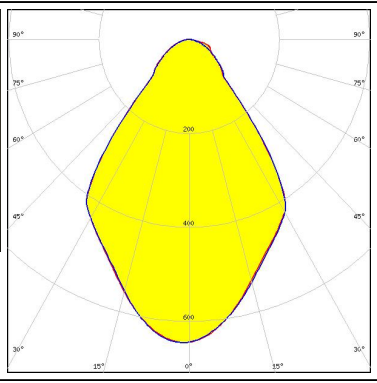
PHOTOMETRIC DATA (MEASURED):

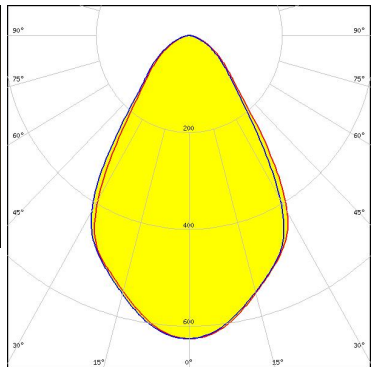
<p>CREE → LED</p> <p>LED CXA/B 1816 & CXA/B 1820 & CXA 1850</p> <p>FWHM / FWTM 73.0° / 118.0°</p> <p>Efficiency 89 %</p> <p>Peak intensity 0.6 cd/lm</p> <p>LEDs/each optic 1</p> <p>Light colour White</p> <p>Required components:</p> <p> IDEAL: 50-2101CR + 50-2100MR</p>		
<p>CREE → LED</p> <p>LED MHD-E/G</p> <p>FWHM / FWTM 78.0° / 126.0°</p> <p>Efficiency 93 %</p> <p>Peak intensity 0.6 cd/lm</p> <p>LEDs/each optic 1</p> <p>Light colour White</p> <p>Required components:</p> <p> C13083_PF-SOCKET</p>		
<p>CREE → LED</p> <p>LED MK-R</p> <p>FWHM / FWTM 77.0° / 118.0°</p> <p>Efficiency 90 %</p> <p>Peak intensity 0.7 cd/lm</p> <p>LEDs/each optic 1</p> <p>Light colour White</p> <p>Required components:</p> <p> C13083_PF-SOCKET</p>		
<p>CREE → LED</p> <p>LED XHP50</p> <p>FWHM / FWTM 79.0° / 121.0°</p> <p>Efficiency 92 %</p> <p>Peak intensity 0.7 cd/lm</p> <p>LEDs/each optic 1</p> <p>Light colour White</p> <p>Required components:</p> <p> C13083_PF-SOCKET</p>		

PHOTOMETRIC DATA (MEASURED):

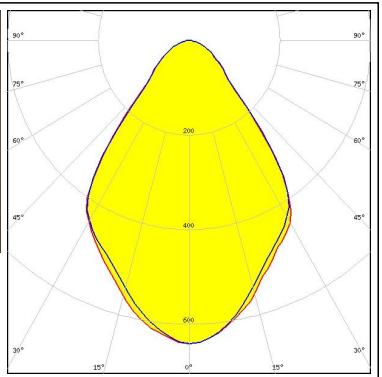
<p>CREE LED</p> <p>LED XHP70 FWHM / FWTM 79.0° / 126.0° Efficiency 90 % Peak intensity 0.6 cd/lm LEDs/each optic 1 Light colour White Required components: C13083_PF-SOCKET</p>		
<p>LUMILEDS</p> <p>LED LUXEON CoB 1202/1203 FWHM / FWTM 69.0° / 119.0° Efficiency 87 % Peak intensity 0.6 cd/lm LEDs/each optic 1 Light colour White Required components: C13333_MIRELLA-CL IDEAL: 50-2100NC +50-2100MR</p>		
<p>LUMILEDS</p> <p>LED LUXEON CoB 1202/1203 FWHM / FWTM 73.0° / 117.0° Efficiency 89 % Peak intensity 0.7 cd/lm LEDs/each optic 1 Light colour White Required components: C13709_PF-SOCKET-VERO13-18 Bender Wirth: 438 Typ L1</p>		
<p>LUMILEDS</p> <p>LED LUXEON CoB 1202/1203 FWHM / FWTM 68.0° / 119.0° Efficiency 86 % Peak intensity 0.6 cd/lm LEDs/each optic 1 Light colour White Required components: C12479_MIRELLA-DL IDEAL: 50-2100NC +50-2100MR</p>		

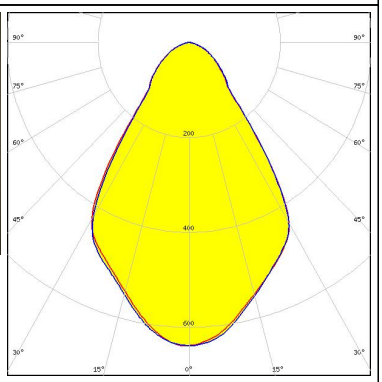
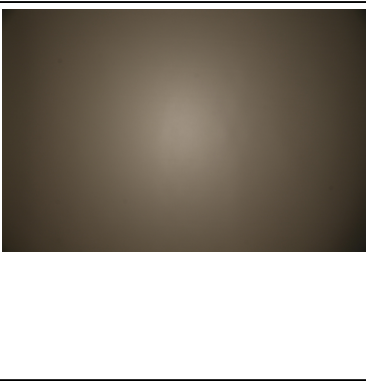
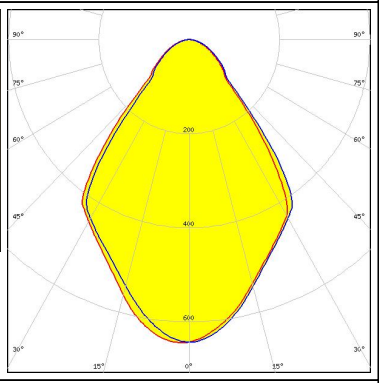
PHOTOMETRIC DATA (MEASURED):

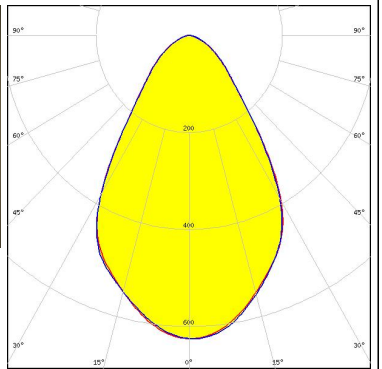
<p>LUMILEDS</p> <p>LED LUXEON CoB 1202/1203</p> <p>FWHM / FWTM 76.0° / 119.0°</p> <p>Efficiency 92 %</p> <p>Peak intensity 0.6 cd/m</p> <p>LEDs/each optic 1</p> <p>Light colour White</p> <p>Required components: C14037_PF-NSX-SOCKET</p>		
<p>LUMILEDS</p> <p>LED LUXEON CoB 1202/1203</p> <p>FWHM / FWTM 69.0° / 117.0°</p> <p>Efficiency 84 %</p> <p>Peak intensity 0.6 cd/m</p> <p>LEDs/each optic 1</p> <p>Light colour White</p> <p>Required components: C13709_PF-SOCKET-VERO13-18 C13333_MIRELLA-CL Bender Wirth: 438 Typ L1</p>		
<p>LUMILEDS</p> <p>LED LUXEON CoB 1202/1203</p> <p>FWHM / FWTM 75.0° / 119.0°</p> <p>Efficiency 93 %</p> <p>Peak intensity 0.6 cd/m</p> <p>LEDs/each optic 1</p> <p>Light colour White</p> <p>Required components: IDEAL: 50-2100NC +50-2100MR</p>		
<p>LUMILEDS</p> <p>LED LUXEON CoB 1202/1203</p> <p>FWHM / FWTM 67.0° / 116.0°</p> <p>Efficiency 83 %</p> <p>Peak intensity 0.6 cd/m</p> <p>LEDs/each optic 1</p> <p>Light colour White</p> <p>Required components: C13709_PF-SOCKET-VERO13-18 C12479_MIRELLA-DL Bender Wirth: 438 Typ L1</p>		

PHOTOMETRIC DATA (MEASURED):

LUMILEDS

LED LUXEON CoB 1202s
 FWHM / FWTM 73.0° / 114.0°
 Efficiency 91 %
 Peak intensity 0.7 cd/lm
 LEDs/each optic 1
 Light colour White
 Required components:
 C13709_PF-SOCKET-VERO13-18
 Bender Wirth: 452 Typ L1

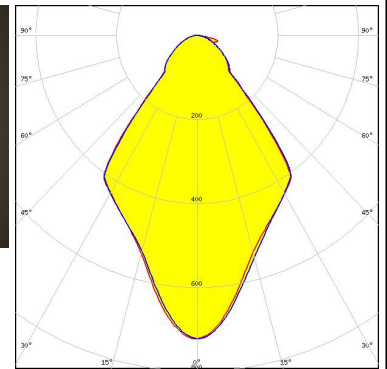
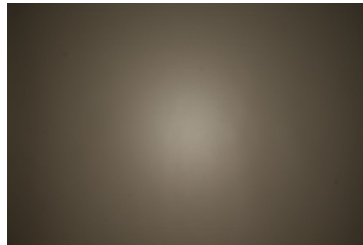

LUMILEDS

LED LUXEON CoB 1202s
 FWHM / FWTM 78.0° / 124.0°
 Efficiency 94 %
 Peak intensity 0.7 cd/lm
 LEDs/each optic 1
 Light colour White
 Required components:
 C13761_PF-SOCKET-CXA15

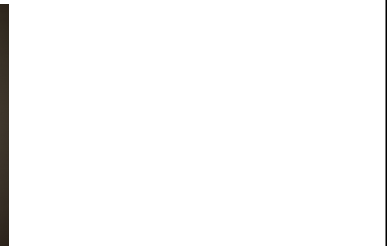
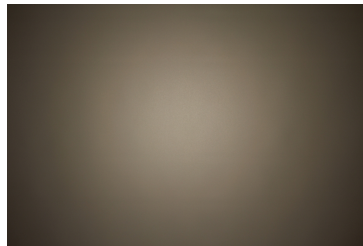

LUMILEDS

LED LUXEON CoB 1202s
 FWHM / FWTM 67.0° / 114.0°
 Efficiency 86 %
 Peak intensity 0.7 cd/lm
 LEDs/each optic 1
 Light colour White
 Required components:
 C13709_PF-SOCKET-VERO13-18
 C13333_MIRELLA-CL
 Bender Wirth: 452 Typ L1

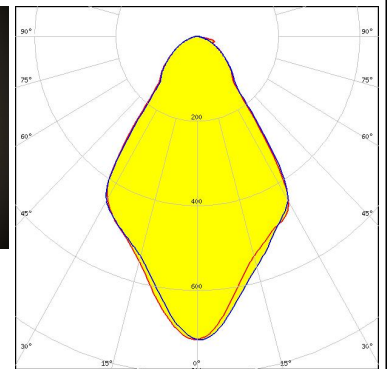
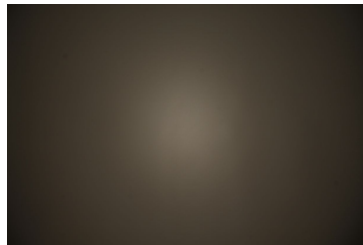

LUMILEDS

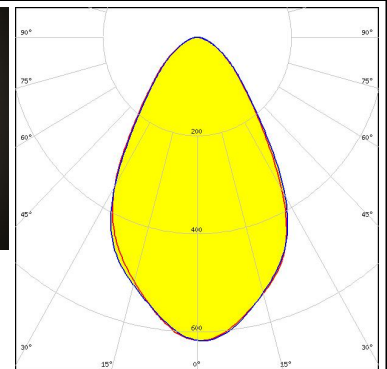
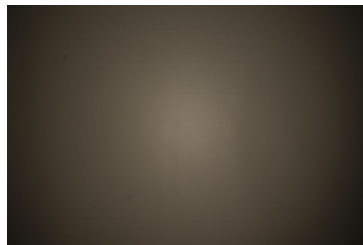

LED LUXEON CoB 1202s
 FWHM / FWTM 65.0° / 117.0°
 Efficiency 82 %
 Peak intensity 0.6 cd/lm
 LEDs/each optic 1
 Light colour White
 Required components:
 C13709_PF-SOCKET-VERO13-18
 C12479_MIRELLA-DL
 Bender Wirth: 452 Typ L1

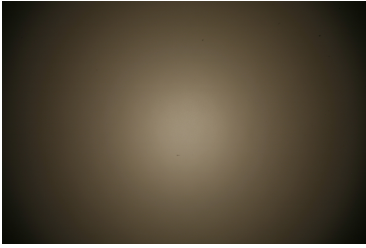
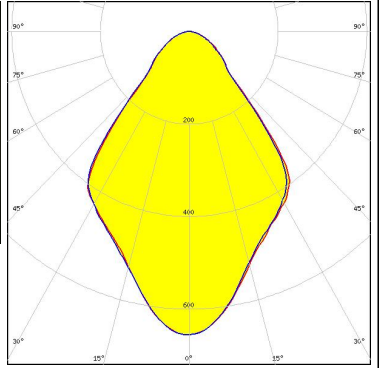
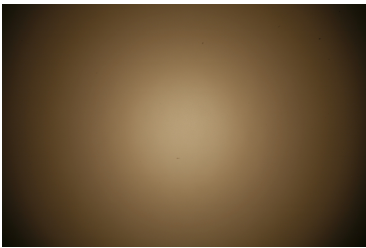
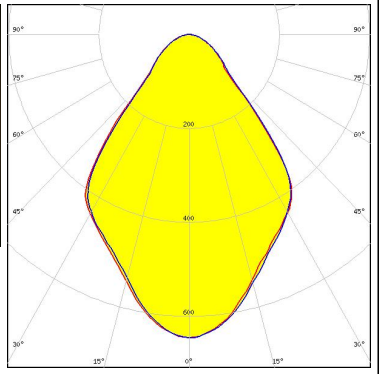
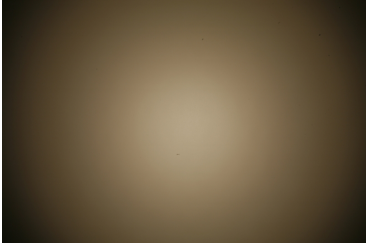
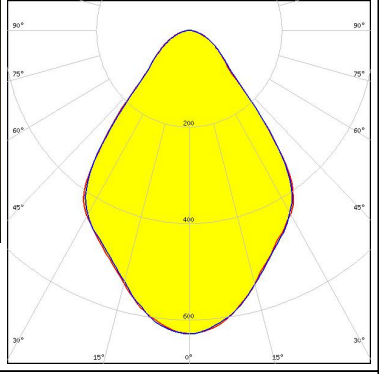
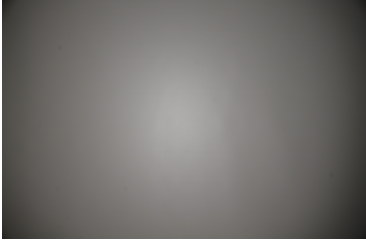
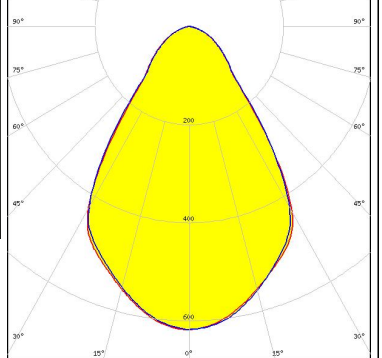

PHOTOMETRIC DATA (MEASURED):

<p>LUMINUS</p> <p>LED CxM-6 (12x13) FWHM / FWTM 77.0° / 120.0° Efficiency 91 % Peak intensity 0.7 cd/lm LEDs/each optic 1 Light colour White Required components: C13083_PF-SOCKET</p>		
<p>LUMINUS</p> <p>LED CXM-7 (13x13) FWHM / FWTM 77.0° / 120.0° Efficiency 92 % Peak intensity 0.7 cd/lm LEDs/each optic 1 Light colour White Required components: C13083_PF-SOCKET</p>		
<p>LUMINUS</p> <p>LED CxM-9 (13.5x13.5) FWHM / FWTM 77.0° / 121.0° Efficiency 92 % Peak intensity 0.6 cd/lm LEDs/each optic 1 Light colour White Required components: C13083_PF-SOCKET</p>		
<p>NICHIA</p> <p>LED COB L-Type (LES 11) FWHM / FWTM 70.0° / 120.0° Efficiency 87 % Peak intensity 0.6 cd/lm LEDs/each optic 1 Light colour White Required components: C13333_MIRELLA-CL IDEAL: 50-2100NC +50-2100MR</p>		

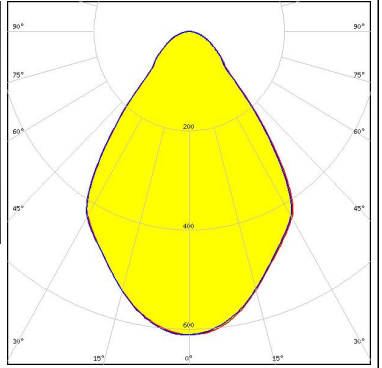
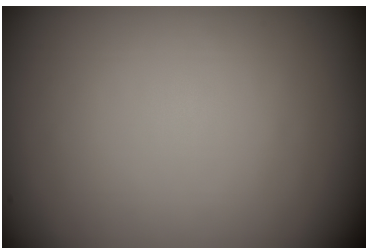
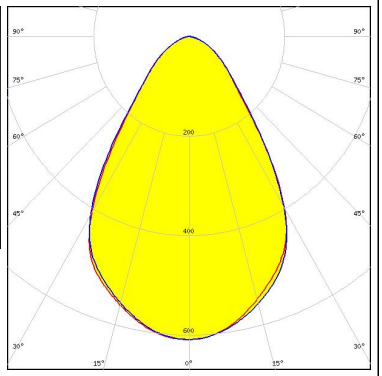
PHOTOMETRIC DATA (MEASURED):

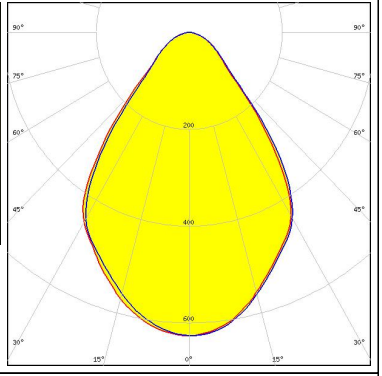
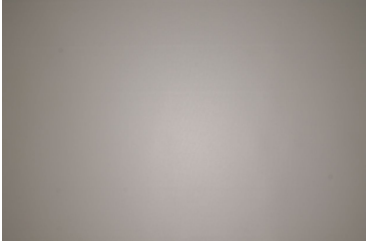
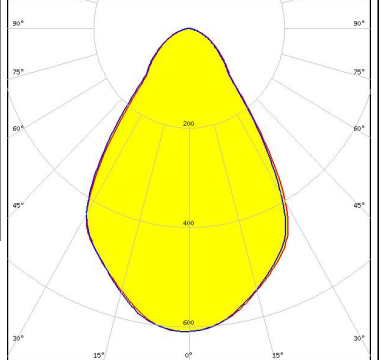
<p>NICHIA</p> <p>LED COB L-Type (LES 11)</p> <p>FWHM / FWTM 73.0° / 118.0°</p> <p>Efficiency 88 %</p> <p>Peak intensity 0.6 cd/m</p> <p>LEDs/each optic 1</p> <p>Light colour White</p> <p>Required components: C13709_PF-SOCKET-VERO13-18 Bender Wirth: 438 Typ L1</p>		
<p>NICHIA</p> <p>LED COB L-Type (LES 11)</p> <p>FWHM / FWTM 69.0° / 120.0°</p> <p>Efficiency 87 %</p> <p>Peak intensity 0.6 cd/m</p> <p>LEDs/each optic 1</p> <p>Light colour White</p> <p>Required components: C12479_MIRELLA-DL IDEAL: 50-2100NC +50-2100MR</p>		
<p>NICHIA</p> <p>LED COB L-Type (LES 11)</p> <p>FWHM / FWTM 75.0° / 120.0°</p> <p>Efficiency 92 %</p> <p>Peak intensity 0.6 cd/m</p> <p>LEDs/each optic 1</p> <p>Light colour White</p> <p>Required components: C14037_PF-NSX-SOCKET</p>		
<p>NICHIA</p> <p>LED COB L-Type (LES 11)</p> <p>FWHM / FWTM 69.0° / 118.0°</p> <p>Efficiency 83 %</p> <p>Peak intensity 0.6 cd/m</p> <p>LEDs/each optic 1</p> <p>Light colour White</p> <p>Required components: C13709_PF-SOCKET-VERO13-18 C13333_MIRELLA-CL Bender Wirth: 438 Typ L1</p>		

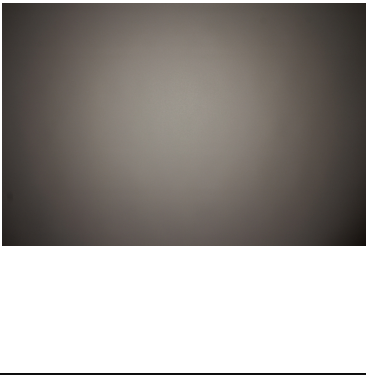
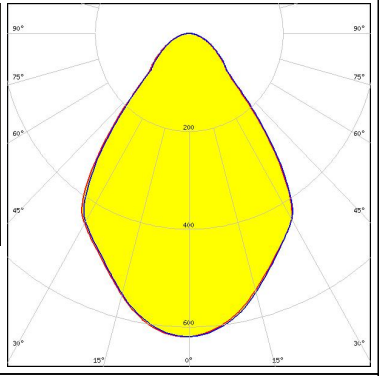
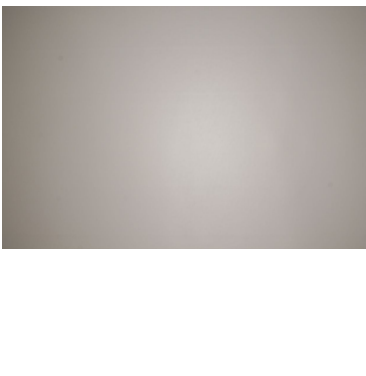
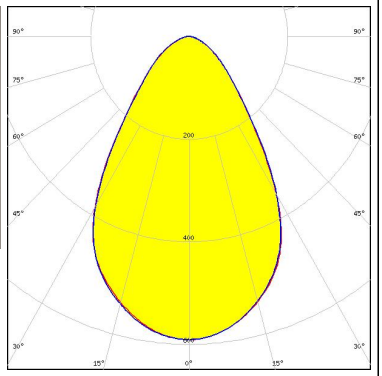
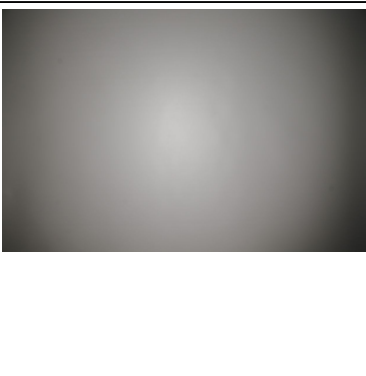
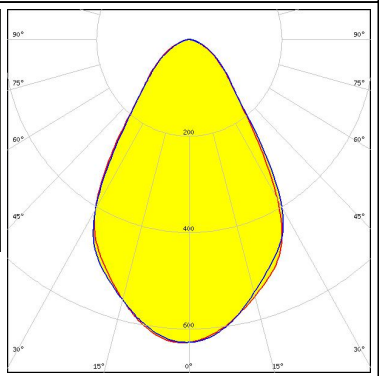
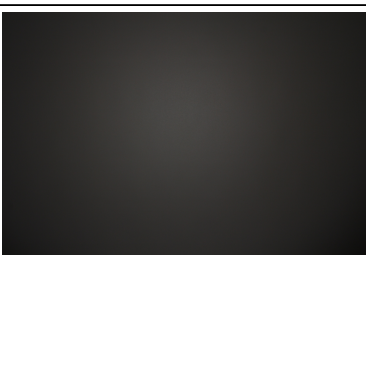
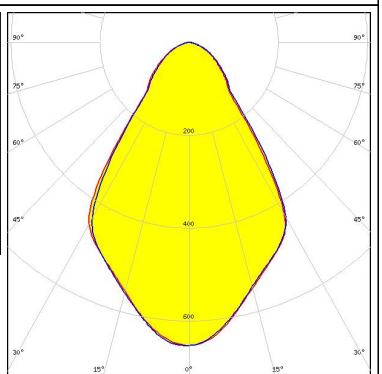

PHOTOMETRIC DATA (MEASURED):

<p>NICHIA</p> <p>LED COB L-Type (LES 11)</p> <p>FWHM / FWTM 75.0° / 120.0°</p> <p>Efficiency 92 %</p> <p>Peak intensity 0.6 cd/m</p> <p>LEDs/each optic 1</p> <p>Light colour White</p> <p>Required components: IDEAL: 50-2100NC +50-2100MR</p>		
<p>NICHIA</p> <p>LED COB L-Type (LES 11)</p> <p>FWHM / FWTM 67.0° / 119.0°</p> <p>Efficiency 82 %</p> <p>Peak intensity 0.6 cd/m</p> <p>LEDs/each optic 1</p> <p>Light colour White</p> <p>Required components: C13709_PF-SOCKET-VERO13-18 C12479_MIRELLA-DL Bender Wirth: 438 Typ L1</p>		
<p>NICHIA</p> <p>LED COB L-Type (LES 9)</p> <p>FWHM / FWTM 67.0° / 118.0°</p> <p>Efficiency 85 %</p> <p>Peak intensity 0.6 cd/m</p> <p>LEDs/each optic 1</p> <p>Light colour White</p> <p>Required components: C13709_PF-SOCKET-VERO13-18 C12479_MIRELLA-DL Bender Wirth: 438 Typ L1</p>		
<p>NICHIA</p> <p>LED COB L-Type (LES 9)</p> <p>FWHM / FWTM 69.0° / 118.0°</p> <p>Efficiency 86 %</p> <p>Peak intensity 0.7 cd/m</p> <p>LEDs/each optic 1</p> <p>Light colour White</p> <p>Required components: C13333_MIRELLA-CL IDEAL: 50-2100NC +50-2100MR</p>		

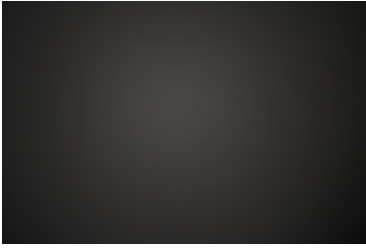
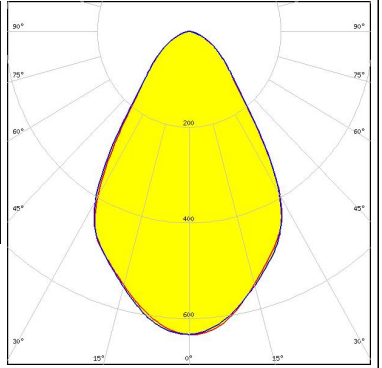
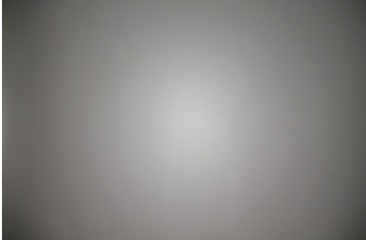
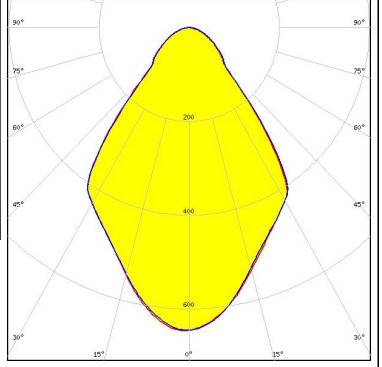
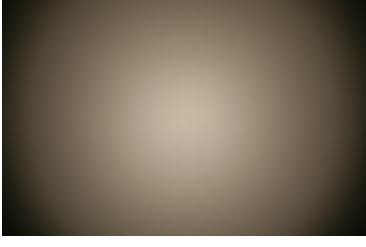
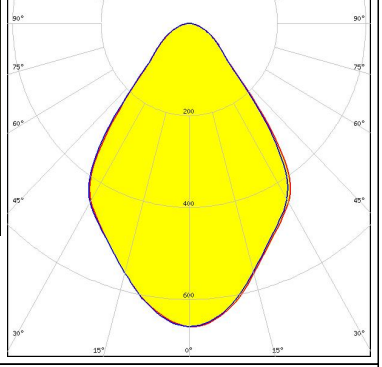
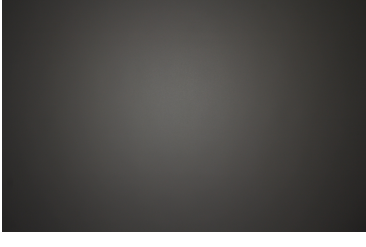
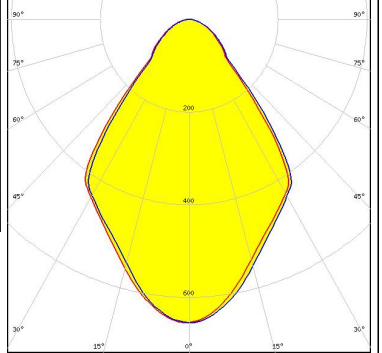
PHOTOMETRIC DATA (MEASURED):

<p>NICHIA</p> <p>LED COB L-Type (LES 9)</p> <p>FWHM / FWTM 67.0° / 118.0°</p> <p>Efficiency 85 %</p> <p>Peak intensity 0.6 cd/lm</p> <p>LEDs/each optic 1</p> <p>Light colour White</p> <p>Required components: C12479_MIRELLA-DL IDEAL: 50-2100NC +50-2100MR</p>		
<p>NICHIA</p> <p>LED COB L-Type (LES 9)</p> <p>FWHM / FWTM 74.0° / 118.0°</p> <p>Efficiency 89 %</p> <p>Peak intensity 0.7 cd/lm</p> <p>LEDs/each optic 1</p> <p>Light colour White</p> <p>Required components: C13709_PF-SOCKET-VERO13-18 Bender Wirth: 438 Typ L1</p>		
<p>NICHIA</p> <p>LED COB L-Type (LES 9)</p> <p>FWHM / FWTM 75.0° / 119.0°</p> <p>Efficiency 93 %</p> <p>Peak intensity 0.7 cd/lm</p> <p>LEDs/each optic 1</p> <p>Light colour White</p> <p>Required components: C14037_PF-NSX-SOCKET</p>		
<p>NICHIA</p> <p>LED COB L-Type (LES 9)</p> <p>FWHM / FWTM 75.0° / 119.0°</p> <p>Efficiency 93 %</p> <p>Peak intensity 0.7 cd/lm</p> <p>LEDs/each optic 1</p> <p>Light colour White</p> <p>Required components: IDEAL: 50-2100NC +50-2100MR</p>		

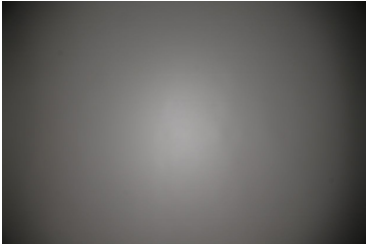
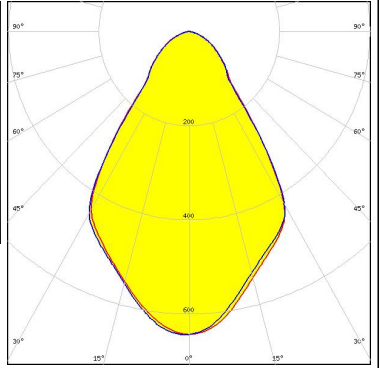
PHOTOMETRIC DATA (MEASURED):

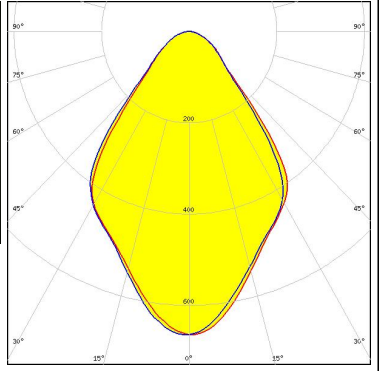
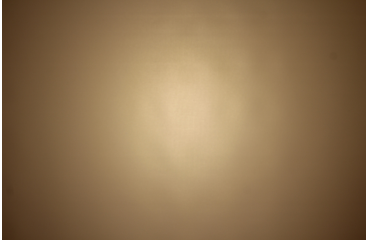
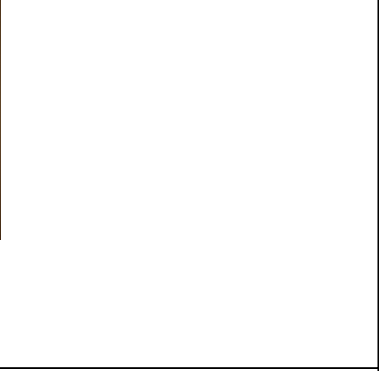
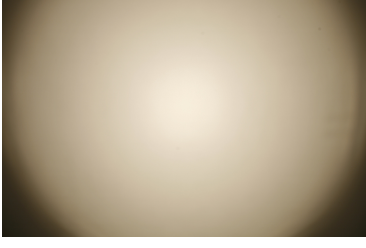
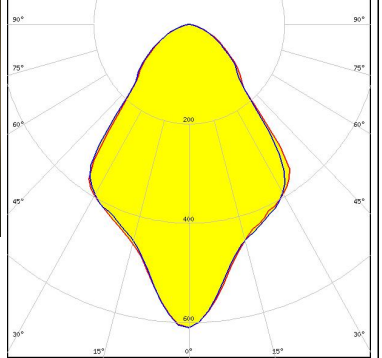
<p>NICHIA</p> <p>LED COB L-Type (LES 9)</p> <p>FWHM / FWTM 68.0° / 118.0°</p> <p>Efficiency 85 %</p> <p>Peak intensity 0.6 cd/lm</p> <p>LEDs/each optic 1</p> <p>Light colour White</p> <p>Required components: C13709_PF-SOCKET-VERO13-18 C13333_MIRELLA-CL Bender Wirth: 438 Typ L1</p>		
<p>NICHIA</p> <p>LED NSCxL036A</p> <p>FWHM / FWTM 75.0° / 118.0°</p> <p>Efficiency 92 %</p> <p>Peak intensity 0.7 cd/lm</p> <p>LEDs/each optic 1</p> <p>Light colour White</p> <p>Required components: C14037_PF-NSX-SOCKET</p>		
<p>OSRAM <small>Opto Semiconductors</small></p> <p>LED Duris S10</p> <p>FWHM / FWTM 79.0° / 90.0°</p> <p>Efficiency 93 %</p> <p>Peak intensity 0.7 cd/lm</p> <p>LEDs/each optic 1</p> <p>Light colour White</p> <p>Required components: C13083_PF-SOCKET</p>		
<p>OSRAM <small>Opto Semiconductors</small></p> <p>LED Duris S8</p> <p>FWHM / FWTM 76.0° / 128.0°</p> <p>Efficiency 86 %</p> <p>Peak intensity 0.6 cd/lm</p> <p>LEDs/each optic 1</p> <p>Light colour White</p> <p>Required components: C13708_PF-SOCKET-VERO10 C13333_MIRELLA-CL</p>		

PHOTOMETRIC DATA (MEASURED):

OSRAM

Opto Semiconductors

LED Duris S8
FWHM / FWTM 75.0° / 126.0°
Efficiency 85 %
Peak intensity 0.6 cd/lm
LEDs/each optic 1
Light colour White
Required components:
C13708_PF-SOCKET-VERO10
C12479_MIRELLA-DL

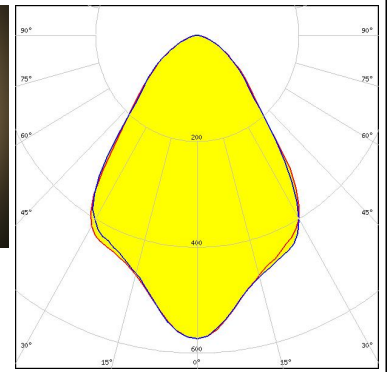

XICATO

LED XTM - 9mm LES
FWHM / FWTM 73.0° / 116.0°
Efficiency 89 %
Peak intensity 0.7 cd/lm
LEDs/each optic 1
Light colour White
Required components:
C14636_XTM-PF-ADAPTER

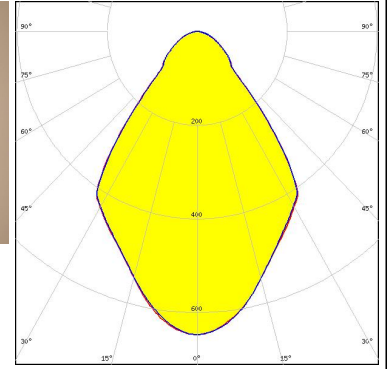
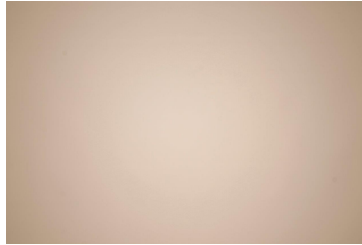

PHOTOMETRIC DATA (SIMULATED):

LUMILEDS

LED LUXEON CoB Compact
FWHM / FWTM 65.0° / 117.0°
Efficiency 82 %
Peak intensity 0.6 cd/lm
LEDs/each optic 1
Light colour White
Required components:
C13709_PF-SOCKET-VERO13-18
C12479_MIRELLA-DL
Bender Wirth: 452 Typ L1

LUMILEDS

LED LUXEON CoB Compact
FWHM / FWTM 73.0° / 114.0°
Efficiency 91 %
Peak intensity 0.7 cd/lm
LEDs/each optic 1
Light colour White
Required components:
C13709_PF-SOCKET-VERO13-18
Bender Wirth: 452 Typ L1

LUMILEDS

LED LUXEON CoB Compact
FWHM / FWTM 78.0° / 124.0°
Efficiency 94 %
Peak intensity 0.7 cd/lm
LEDs/each optic 1
Light colour White
Required components:
C13761_PF-SOCKET-CXA15

LUMILEDS

LED LUXEON CoB Compact
FWHM / FWTM 67.0° / 114.0°
Efficiency 86 %
Peak intensity 0.7 cd/lm
LEDs/each optic 1
Light colour White
Required components:
C13709_PF-SOCKET-VERO13-18
C13333_MIRELLA-CL
Bender Wirth: 452 Typ L1

PHOTOMETRIC DATA (SIMULATED):

LUMINUS

LED CxM-14 (19x19)
FWHM / FWTM 67.0° / 117.0°
Efficiency 76 %
Peak intensity 0.6 cd/lm
LEDs/each optic 1
Light colour White
Required components:
C13709_PF-SOCKET-VERO13-18
C12479_MIRELLA-DL
Bender Wirth: 433 Typ L1

LUMINUS

LED CxM-14 (19x19)
FWHM / FWTM 74.0° / 117.0°
Efficiency 82 %
Peak intensity 0.6 cd/lm
LEDs/each optic 1
Light colour White
Required components:
C13709_PF-SOCKET-VERO13-18
Bender Wirth: 433 Typ L1

LUMINUS

LED CxM-14 (19x19)
FWHM / FWTM 69.0° / 119.0°
Efficiency 78 %
Peak intensity 0.6 cd/lm
LEDs/each optic 1
Light colour White
Required components:
C13709_PF-SOCKET-VERO13-18
C13333_MIRELLA-CL
Bender Wirth: 433 Typ L1

LUMINUS

LED CxM-9 (13.5x13.5)
FWHM / FWTM 73.0° / 116.0°
Efficiency 89 %
Peak intensity 0.7 cd/lm
LEDs/each optic 1
Light colour White
Required components:
C13709_PF-SOCKET-VERO13-18
Bender Wirth: 434 Typ L1

PHOTOMETRIC DATA (SIMULATED):

LUMINUS

LED CxM-9 (13.5x13.5)
FWHM / FWTM 68.0° / 117.0°
Efficiency 85 %
Peak intensity 0.7 cd/lm
LEDs/each optic 1
Light colour White
Required components:
C13709_PF-SOCKET-VERO13-18
C13333_MIRELLA-CL
Bender Wirth: 434 Typ L1

LUMINUS

LED CxM-9 (13.5x13.5)
FWHM / FWTM 67.0° / 117.0°
Efficiency 80 %
Peak intensity 0.6 cd/lm
LEDs/each optic 1
Light colour White
Required components:
C13709_PF-SOCKET-VERO13-18
C12479_MIRELLA-DL
Bender Wirth: 434 Typ L1

NICHIA

LED COB S-Type (LES 7)
FWHM / FWTM 65.0° / 117.0°
Efficiency 82 %
Peak intensity 0.6 cd/lm
LEDs/each optic 1
Light colour White
Required components:
C13709_PF-SOCKET-VERO13-18
C12479_MIRELLA-DL
Bender Wirth: 452 Typ L1

NICHIA

LED COB S-Type (LES 7)
FWHM / FWTM 73.0° / 114.0°
Efficiency 91 %
Peak intensity 0.7 cd/lm
LEDs/each optic 1
Light colour White
Required components:
C13709_PF-SOCKET-VERO13-18
Bender Wirth: 452 Typ L1

PHOTOMETRIC DATA (SIMULATED):

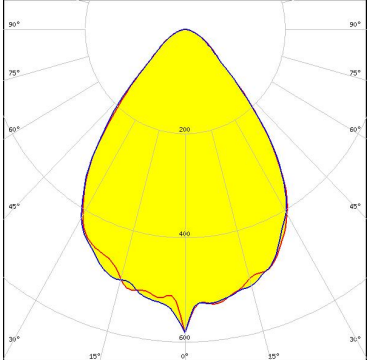
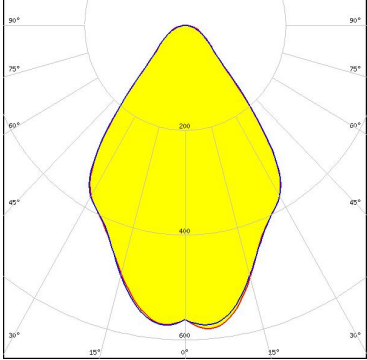
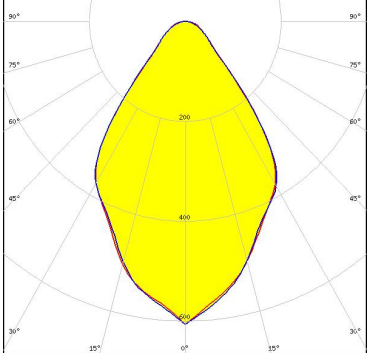
<p>NICHIA</p> <p>LED COB S-Type (LES 7)</p> <p>FWHM / FWTM 67.0° / 114.0°</p> <p>Efficiency 86 %</p> <p>Peak intensity 0.7 cd/lm</p> <p>LEDs/each optic 1</p> <p>Light colour White</p> <p>Required components: C13709_PF-SOCKET-VERO13-18 C13333_MIRELLA-CL Bender Wirth: 452 Typ L1</p>	
<p>OSRAM Opto Semiconductors</p> <p>LED Soleriq S15</p> <p>FWHM / FWTM 76.0° / 114.0°</p> <p>Efficiency 83 %</p> <p>Peak intensity 0.6 cd/lm</p> <p>LEDs/each optic 1</p> <p>Light colour White</p> <p>Required components: C13709_PF-SOCKET-VERO13-18 Bender Wirth: 433 Typ L1</p>	
<p>SAMSUNG</p> <p>LED LC010C</p> <p>FWHM / FWTM 72.0° / 110.0°</p> <p>Efficiency 78 %</p> <p>Peak intensity 0.6 cd/lm</p> <p>LEDs/each optic 1</p> <p>Light colour White</p> <p>Required components: C13709_PF-SOCKET-VERO13-18 Bender Wirth: 479 Typ L1</p>	
<p>SAMSUNG</p> <p>LED LC020C</p> <p>FWHM / FWTM 71.0° / 107.0°</p> <p>Efficiency 77 %</p> <p>Peak intensity 0.6 cd/lm</p> <p>LEDs/each optic 1</p> <p>Light colour White</p> <p>Required components: C13709_PF-SOCKET-VERO13-18 Bender Wirth: 479 Typ L1</p>	

PHOTOMETRIC DATA (SIMULATED):

SAMSUNG

LED LC040C
 FWHM / FWTM 73.0° / 113.0°
 Efficiency 74 %
 Peak intensity 0.5 cd/lm
 LEDs/each optic 1
 Light colour White
 Required components:
 C13709_PF-SOCKET-VERO13-18
 Bender Wirth: 480 Typ L1

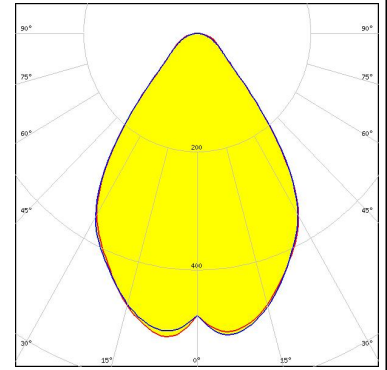

SEOUL SEMICONDUCTOR

LED ZC4/6
 FWHM / FWTM 68.0° / 117.0°
 Efficiency 85 %
 Peak intensity 0.7 cd/lm
 LEDs/each optic 1
 Light colour White
 Required components:
 C13709_PF-SOCKET-VERO13-18
 C13333_MIRELLA-CL
 Bender Wirth: 434 Typ L1



SEOUL SEMICONDUCTOR

LED ZC4/6
 FWHM / FWTM 67.0° / 117.0°
 Efficiency 80 %
 Peak intensity 0.6 cd/lm
 LEDs/each optic 1
 Light colour White
 Required components:
 C13709_PF-SOCKET-VERO13-18
 C12479_MIRELLA-DL
 Bender Wirth: 434 Typ L1



SEOUL SEMICONDUCTOR

LED ZC4/6
 FWHM / FWTM 73.0° / 116.0°
 Efficiency 89 %
 Peak intensity 0.7 cd/lm
 LEDs/each optic 1
 Light colour White
 Required components:
 C13709_PF-SOCKET-VERO13-18
 Bender Wirth: 434 Typ L1

GENERAL INFORMATION:

NOTE: The typical beam angle will be changed by different color, chip size and chip position tolerance. The typical total beam angle is the full angle measured where the luminous intensity is half of the peak value.

Due to use of high power COB's with this product, special attention to proper thermal design is highly recommended. LEDiL has no liability for direct, indirect or consecutive damages arising from the LEDiL products being used outside of the recommended temperature range.

MATERIALS:

As part of our continuous research and improvement processes, and to ensure the best possible quality and availability of our products, LEDiL reserves the right to change material grades without notice.

PRODUCT DATA USER AGREEMENT AND DISCLAIMER:

The measured data in the provided downloadable LEDiL Product Datasheets and Mechanical 2D-Drawings is rounded and provided as reference for planning. LEDiL Oy's optical specifications have been verified by conducting performance testing of the products in accordance with the company's quality system. The reported data are averaged results of multiple measurements with typical variation. LEDiL Oy reserves the right to without prior notification make changes and improvements to its products.

LEDiL Oy assumes neither warranty, nor guarantee nor any other liability of any kind for the contents and correctness of the provided data. The provided data has been generated with highest diligence but the provided data may in reality not represent the complete possible variation range of all intrinsic parameters. Therefore, in certain cases a deviation from the provided data could occur.

LEDiL Oy reserves the right to undertake technical changes of its products without further notification which could lead to changes in the provided data. LEDiL Oy assumes no liability of any kind for the possible deviation from any provided data or any other damage resulting from the usage of the provided data.

The user agrees to this disclaimer and user agreement with the download or usage of the provided files.

LEDiL Oy

Joensuunkatu 13
FI-24240 SALO
Finland

LEDiL Inc.

228 West Page Street
Suite D
Sycamore IL 60178
USA

Ledil Optics Technology (Shenzhen) Co., Ltd.

405 , Block B
Casic Motor Building
Shenzhen 518057
P.R.CHINA

Local sales and technical support

[www.ledil.com/
where_to_buy](http://www.ledil.com/where_to_buy)

Shipping locations

Salo, Finland
Hong Kong, China

Distribution Partners

[www.ledil.com/
where_to_buy](http://www.ledil.com/where_to_buy)