

TUIJA-3-SS

~12° smooth spot beam

TECHNICAL SPECIFICATIONS:

Dimensions	Ø 50.0 mm
Height	14.5 mm
Fastening	glue, pin
ROHS compliant	yes ⓘ



MATERIAL SPECIFICATIONS:

Component	Type	Material	Colour	Finish
TUIJA-3-SS	Multi-lens	PMMA	clear	





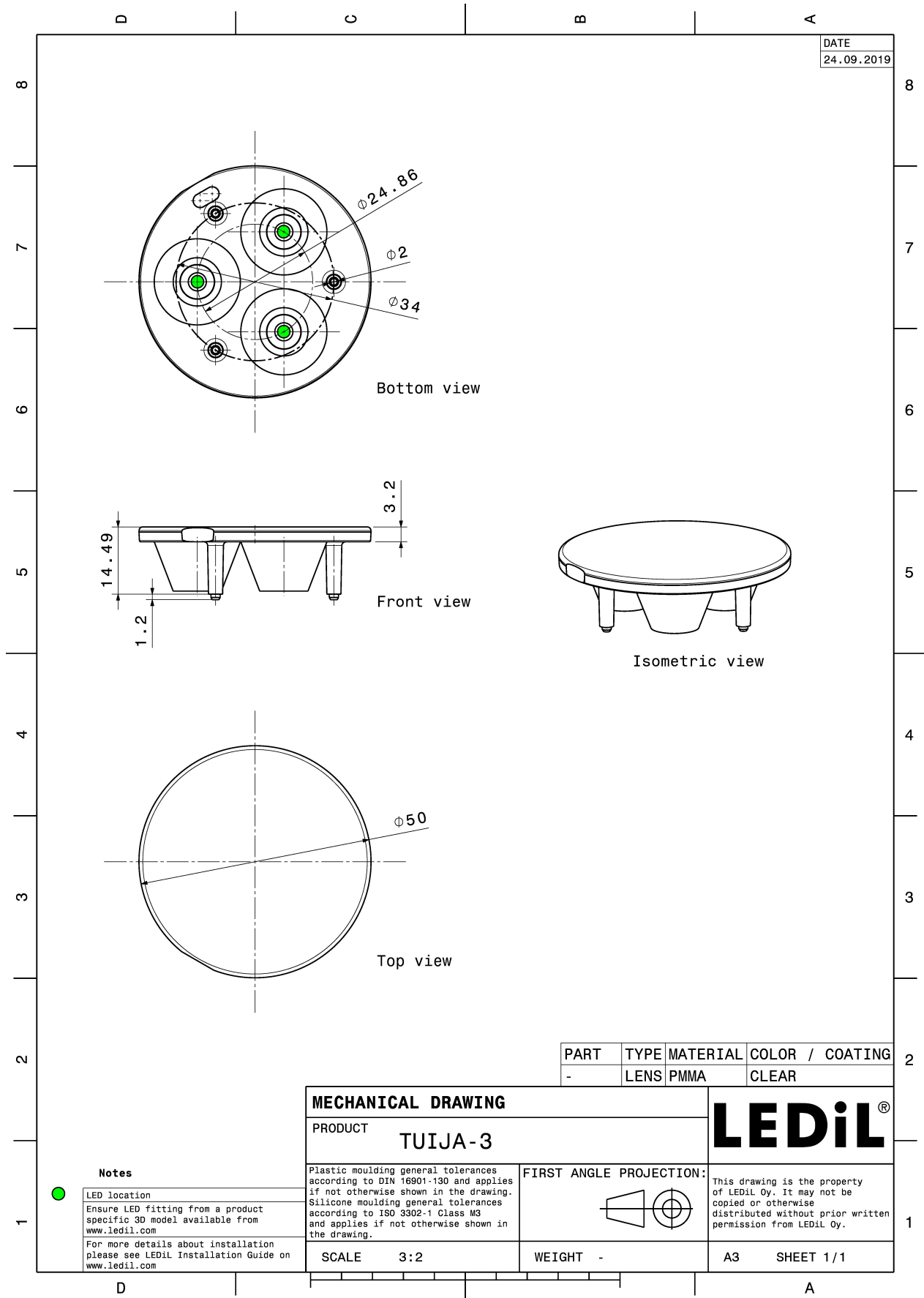

ORDERING INFORMATION:

Component	Qty in box	MOQ	MPQ	Box weight (kg)
C11192_TUIJA-3-SS » Box size: 480 x 280 x 300 mm	364	112	28	6.6

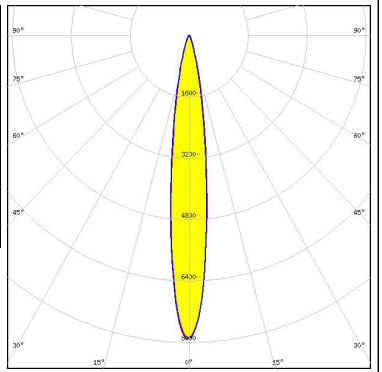

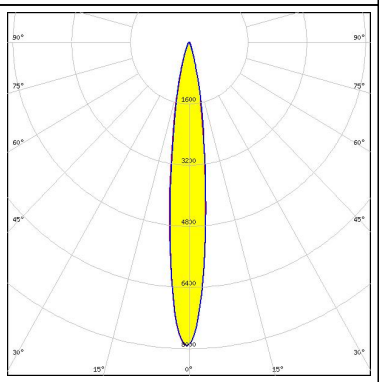
See also our general installation guide: www.ledil.com/installation_guide

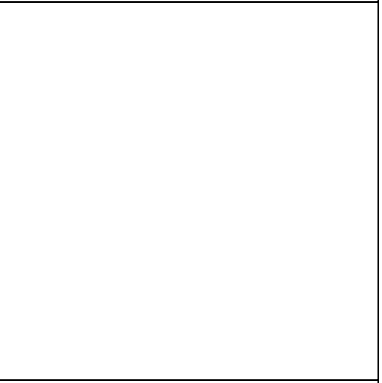
PHOTOMETRIC DATA (MEASURED):

<p>CREE → LED</p> <p>LED XB-D FWHM / FWTM 14.0° / 32.0° Efficiency 94 % Peak intensity 7.9 cd/lm LEDs/each optic 1 Light colour White Required components:</p>		
<p>CREE → LED</p> <p>LED XB-D FWHM / FWTM 14.0° / 32.0° Efficiency 94 % Peak intensity 7.9 cd/lm LEDs/each optic 1 Light colour White Required components:</p>		
<p>CREE → LED</p> <p>LED XP-E FWHM / FWTM 12.0° / 25.0° Efficiency 90 % Peak intensity 14.1 cd/lm LEDs/each optic 1 Light colour White Required components:</p>		
<p>CREE → LED</p> <p>LED XP-G FWHM / FWTM 14.0° / 29.0° Efficiency 90 % Peak intensity 9.6 cd/lm LEDs/each optic 1 Light colour White Required components:</p>		

PHOTOMETRIC DATA (MEASURED):



LED XT-E
FWHM / FWTM 13.0° / 30.0°
Efficiency 94 %
Peak intensity 11 cd/lm
LEDs/each optic 1
Light colour White
Required components:

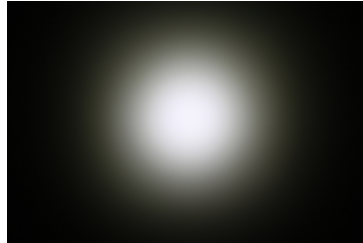

LED LUXEON A
FWHM / FWTM 12.0°
Efficiency 90 %
LEDs/each optic 1
Light colour White
Required components:







LED LUXEON Rebel
FWHM / FWTM 12.0° / 22.0°
Efficiency 90 %
Peak intensity 16.8 cd/lm
LEDs/each optic 1
Light colour White
Required components:



LED LUXEON Rebel ES
FWHM / FWTM 13.0° / 27.0°
Efficiency 90 %
Peak intensity 11.1 cd/lm
LEDs/each optic 1
Light colour White
Required components:

PHOTOMETRIC DATA (MEASURED):

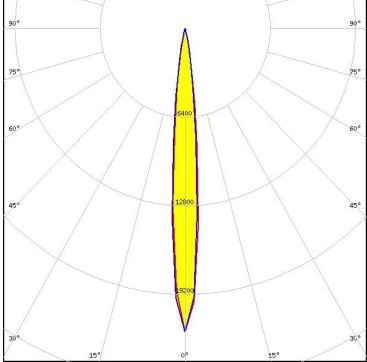





	
LED	NCSxx19A
FWHM / FWTM	12.0°
Efficiency	90 %
LEDs/each optic	1
Light colour	White
Required components:	
	
LED	NVSxx19A
FWHM / FWTM	10.5°
Efficiency	90 %
LEDs/each optic	1
Light colour	White
Required components:	
 <small>Osram Semiconductors</small>	
LED	OSLON SSL 80
FWHM / FWTM	10.0° / 21.0°
Efficiency	90 %
Peak intensity	4.6 cd/lm
LEDs/each optic	1
Light colour	White
Required components:	
 <small>SEOUL SEMICONDUCTOR</small>	
LED	Z5
FWHM / FWTM	10.0° / 22.0°
Efficiency	93 %
Peak intensity	22 cd/lm
LEDs/each optic	1
Light colour	White
Required components:	
	

PHOTOMETRIC DATA (MEASURED):

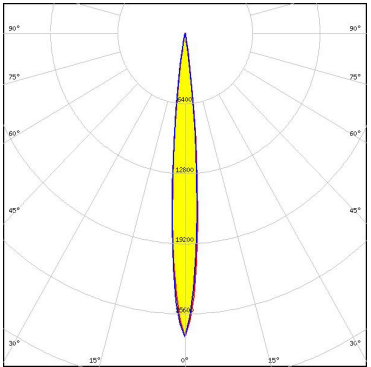
SHARP

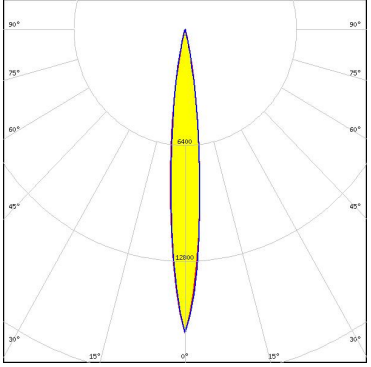
LED	Double Dome (GM2BB)
FWHM / FWTM	12.0°
Efficiency	90 %
LEDs/each optic	1
Light colour	White
Required components:	

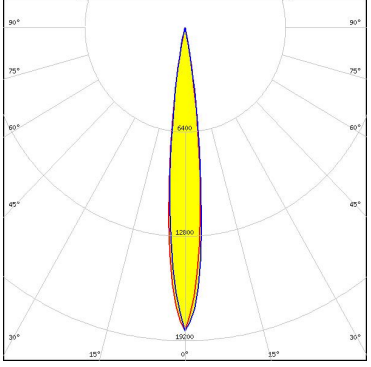
PHOTOMETRIC DATA (SIMULATED):

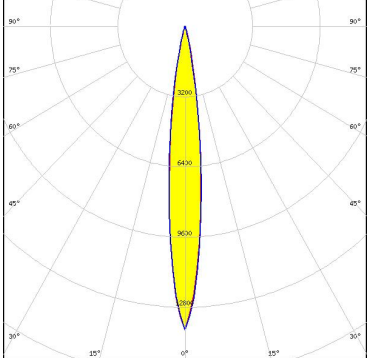
	<p>LED: XD16 FWHM / FWTM: 9.5° / 18.0° Efficiency: 94 % Peak intensity: 27.8 cd/lm LEDs/each optic: 1 Light colour: White Required components:</p>	
	<p>LED: XP-L HD FWHM / FWTM: 12.0° / 24.0° Efficiency: 97 % Peak intensity: 16.7 cd/lm LEDs/each optic: 1 Light colour: White Required components:</p>	
	<p>LED: XP-L HI FWHM / FWTM: 12.0° / 22.0° Efficiency: 97 % Peak intensity: 18.6 cd/lm LEDs/each optic: 1 Light colour: White Required components:</p>	
	<p>LED: XP-L2 FWHM / FWTM: 12.0° / 26.0° Efficiency: 97 % Peak intensity: 13.8 cd/lm LEDs/each optic: 1 Light colour: White Required components:</p>	

PHOTOMETRIC DATA (SIMULATED):

<p>LUMILEDS</p> <p>LED LUXEON Rebel Plus</p> <p>FWHM / FWTM 10.0° / 21.0°</p> <p>Efficiency 96 %</p> <p>Peak intensity 20.1 cd/lm</p> <p>LEDs/each optic 1</p> <p>Light colour White</p> <p>Required components:</p>	
<p>OSRAM Opto Semiconductors</p> <p>LED OSCONIQ P 3737 (3W version)</p> <p>FWHM / FWTM 11.0° / 22.0°</p> <p>Efficiency 97 %</p> <p>Peak intensity 19 cd/lm</p> <p>LEDs/each optic 1</p> <p>Light colour White</p> <p>Required components:</p>	
<p>OSRAM Opto Semiconductors</p> <p>LED OSLON Square CSSRM2/CSSRM3</p> <p>FWHM / FWTM 11.0° / 20.0°</p> <p>Efficiency 94 %</p> <p>Peak intensity 23.6 cd/lm</p> <p>LEDs/each optic 1</p> <p>Light colour White</p> <p>Required components:</p>	
<p>OSRAM Opto Semiconductors</p> <p>LED OSLON SSL 150</p> <p>FWHM / FWTM 12.0°</p> <p>Efficiency %</p> <p>Peak intensity 17 cd/lm</p> <p>LEDs/each optic 1</p> <p>Light colour White</p> <p>Required components:</p>	

PHOTOMETRIC DATA (SIMULATED):

OSRAM

Opto Semiconductors

LED SFH 4715AS
 FWHM / FWTM 12.0° / 24.0°
 Efficiency 94 %
 Peak intensity 17.1 cd/lm
 LEDs/each optic 1
 Light colour IR
 Required components:

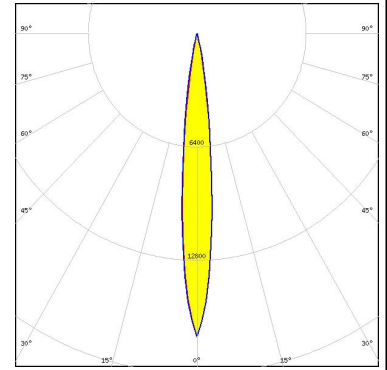

OSRAM

Opto Semiconductors

LED SFH 4716AS
 FWHM / FWTM 12.0° / 24.0°
 Efficiency 94 %
 Peak intensity 17.1 cd/lm
 LEDs/each optic 1
 Light colour IR
 Required components:

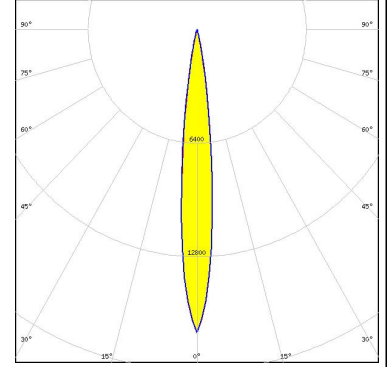

SAMSUNG

LED LH351D
 FWHM / FWTM 12.0° / 26.0°
 Efficiency 96 %
 Peak intensity 14.5 cd/lm
 LEDs/each optic 1
 Light colour White
 Required components:

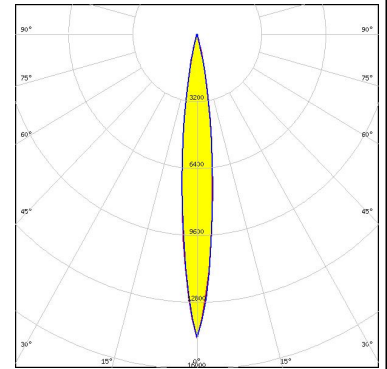

GENERAL INFORMATION:

NOTE: The typical beam angle will be changed by different color, chip size and chip position tolerance. The typical total beam angle is the full angle measured where the luminous intensity is half of the peak value.

MATERIALS:

As part of our continuous research and improvement processes, and to ensure the best possible quality and availability of our products, LEDiL reserves the right to change material grades without notice.

PRODUCT DATA USER AGREEMENT AND DISCLAIMER:

The measured data in the provided downloadable LEDiL Product Datasheets and Mechanical 2D-Drawings is rounded and provided as reference for planning. LEDiL Oy's optical specifications have been verified by conducting performance testing of the products in accordance with the company's quality system. The reported data are averaged results of multiple measurements with typical variation. LEDiL Oy reserves the right to without prior notification make changes and improvements to its products.

LEDiL Oy assumes neither warranty, nor guarantee nor any other liability of any kind for the contents and correctness of the provided data. The provided data has been generated with highest diligence but the provided data may in reality not represent the complete possible variation range of all intrinsic parameters. Therefore, in certain cases a deviation from the provided data could occur.

LEDiL Oy reserves the right to undertake technical changes of its products without further notification which could lead to changes in the provided data. LEDiL Oy assumes no liability of any kind for the possible deviation from any provided data or any other damage resulting from the usage of the provided data.

The user agrees to this disclaimer and user agreement with the download or usage of the provided files.

LEDiL Oy

Joensuunkatu 13
FI-24240 SALO
Finland

LEDiL Inc.

228 West Page Street
Suite D
Sycamore IL 60178
USA

Ledil Optics Technology (Shenzhen) Co., Ltd.

405 , Block B
Casic Motor Building
Shenzhen 518057
P.R.CHINA

Local sales and technical support

[www.ledil.com/
where_to_buy](http://www.ledil.com/where_to_buy)

Shipping locations

Salo, Finland
Hong Kong, China

Distribution Partners

[www.ledil.com/
where_to_buy](http://www.ledil.com/where_to_buy)