

TINA2-R-CLIP16

Mini reflector with ~60° wide beam and clip installation

TECHNICAL SPECIFICATIONS:

Dimensions	Ø 16.1 mm
Height	10.1 mm
Fastening	clips
ROHS compliant	yes ⓘ

MATERIAL SPECIFICATIONS:

Component	Type	Material	Colour	Finish	Coating
TINA2-R-CLIP16	Reflector	HRPC	clear		

ORDERING INFORMATION:

Component	Qty in box	MOQ	MPQ	Box weight (kg)
C13253_TINA2-R-CLIP16 » Box size: 300 x 250 x 250 mm		300	50	3.8



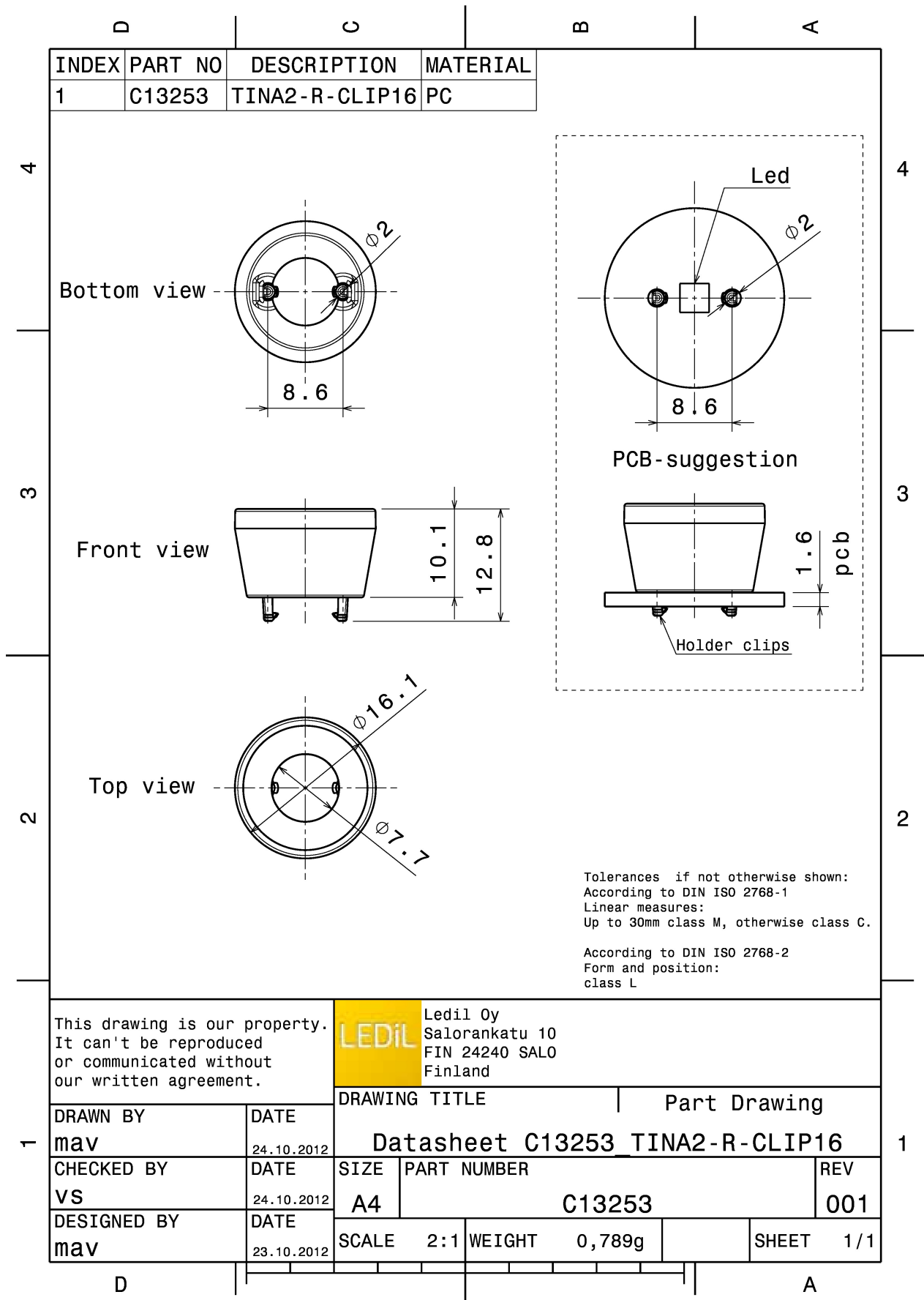





This drawing is our property. It can't be reproduced or communicated without our written agreement.

LEDiL Ledil Oy
 Salorankatu 10
 FIN 24240 SALO
 Finland



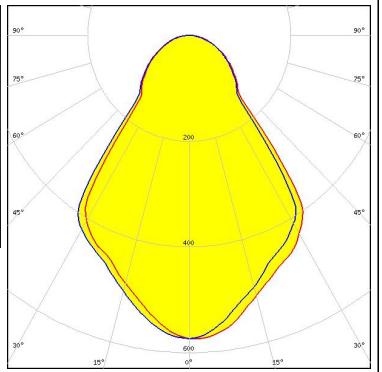
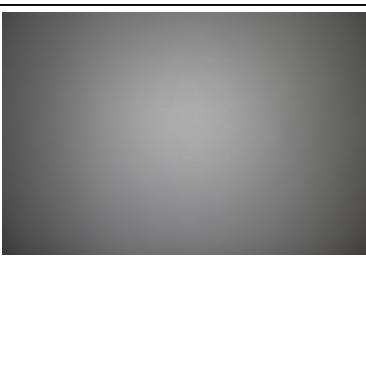
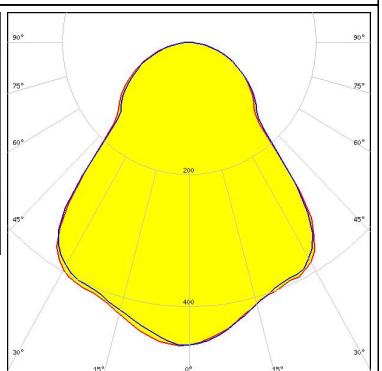

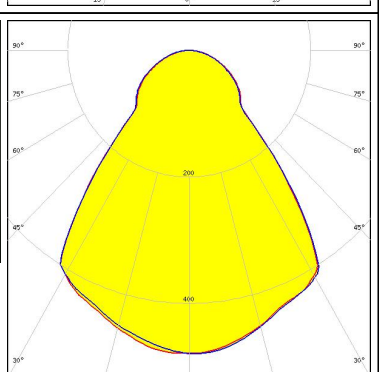

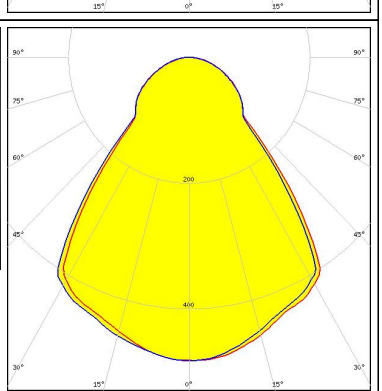

DRAWN BY mav		DATE 24.10.2012	DRAWING TITLE Datasheet C13253 TINA2-R-CLIP16		Part Drawing
CHECKED BY VS	DATE 24.10.2012	SIZE A4	PART NUMBER C13253	REV 001	
DESIGNED BY mav	DATE 23.10.2012	SCALE 2:1	WEIGHT 0,789g	SHEET 1/1	

See also our general installation guide: www.ledil.com/installation_guide

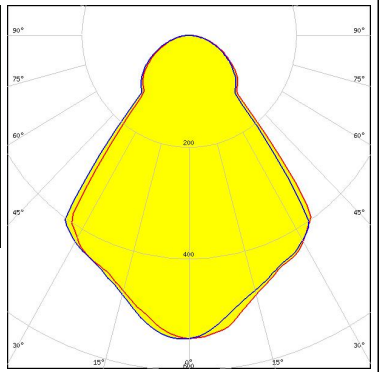
PHOTOMETRIC DATA (MEASURED):

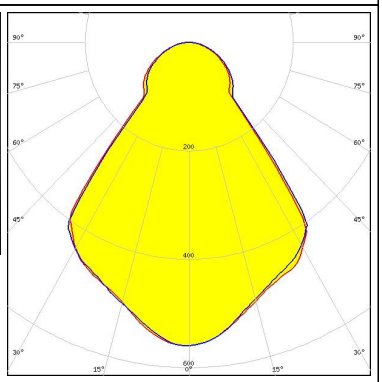
<p>CREE → LED</p> <p>LED XB-D White FWHM / FWTM 73.0° / 135.0° Efficiency 90 % Peak intensity 0.6 cd/lm LEDs/each optic 1 Light colour White Required components:</p>		
<p>CREE → LED</p> <p>LED XB-H FWHM / FWTM 81.0° / 151.0° Efficiency 92 % Peak intensity 0.5 cd/lm LEDs/each optic 1 Light colour White Required components:</p>		
<p>CREE → LED</p> <p>LED XM-L FWHM / FWTM 78.0° / 142.0° Efficiency 88 % Peak intensity 0.5 cd/lm LEDs/each optic 1 Light colour White Required components:</p>		
<p>CREE → LED</p> <p>LED XM-L2 FWHM / FWTM 78.0° / 142.0° Efficiency 90 % Peak intensity 0.5 cd/lm LEDs/each optic 1 Light colour White Required components:</p>		

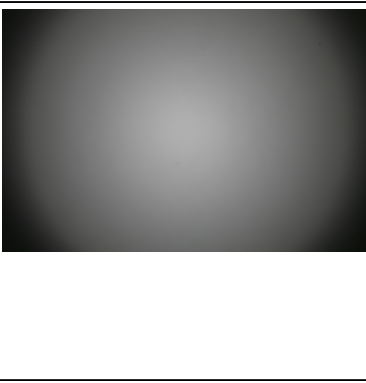
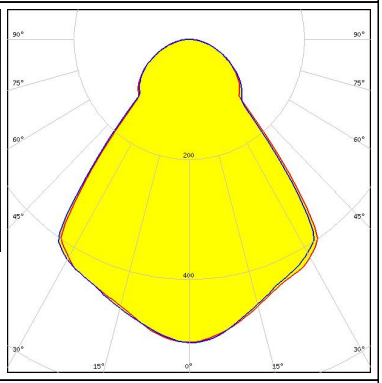
PHOTOMETRIC DATA (MEASURED):

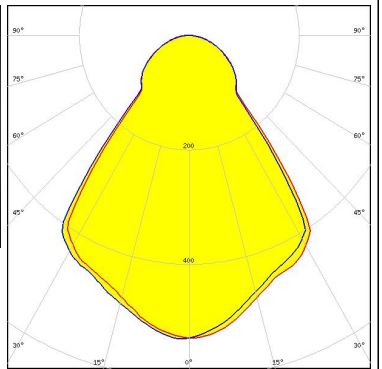
<p>CREE  LED</p> <p>LED XP-E FWHM / FWTM 74.0° / 138.0° Efficiency 90 % Peak intensity 0.5 cd/lm LEDs/each optic 1 Light colour White Required components:</p>		
<p>CREE  LED</p> <p>LED XP-E2 FWHM / FWTM 74.0° / 136.0° Efficiency 90 % Peak intensity 0.6 cd/lm LEDs/each optic 1 Light colour White Required components:</p>		
<p>CREE  LED</p> <p>LED XP-G FWHM / FWTM 77.0° / 141.0° Efficiency 90 % Peak intensity 0.5 cd/lm LEDs/each optic 1 Light colour White Required components:</p>		
<p>CREE  LED</p> <p>LED XP-G2 FWHM / FWTM 75.0° / 138.0° Efficiency 89 % Peak intensity 0.5 cd/lm LEDs/each optic 1 Light colour White Required components:</p>		



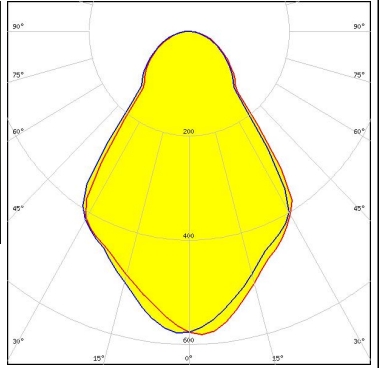
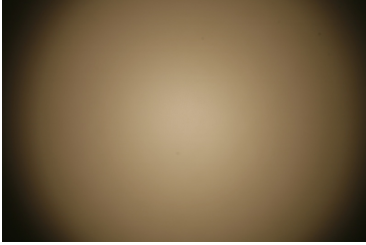
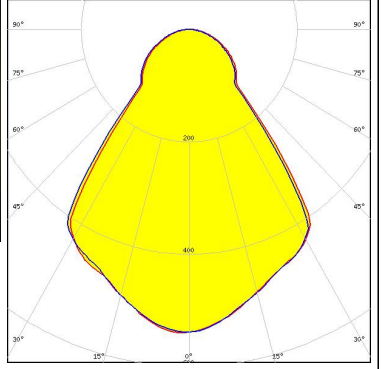
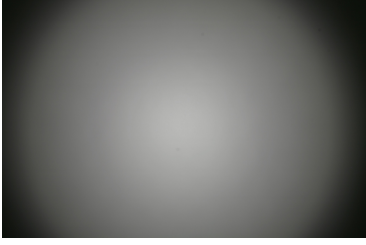
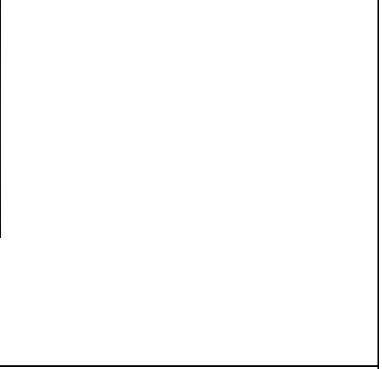
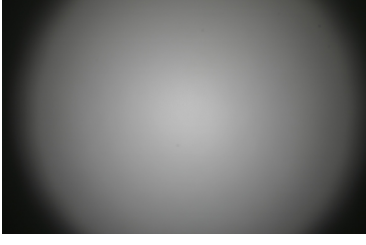
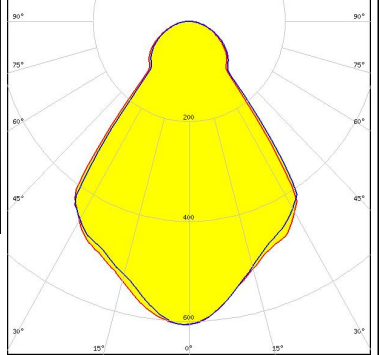

PHOTOMETRIC DATA (MEASURED):

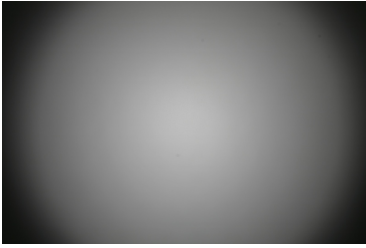
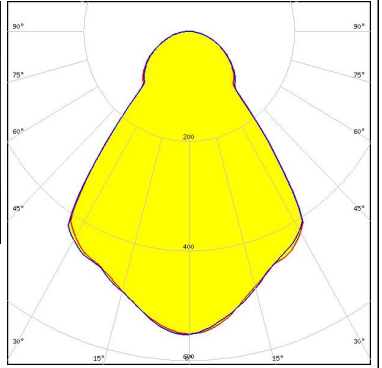
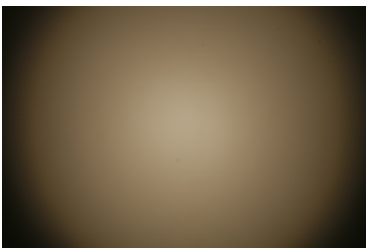
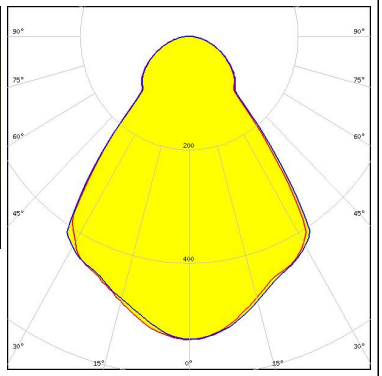
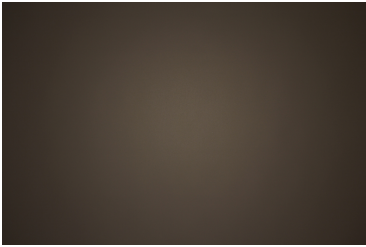
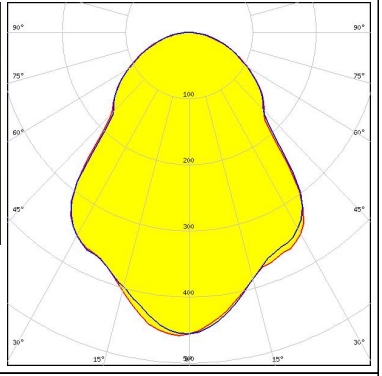
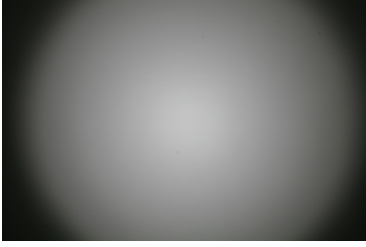
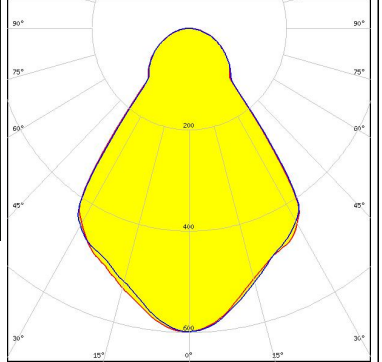
<p>CREE LED</p> <p>LED XT-E FWHM / FWTM 71.0° / 133.0° Efficiency 87 % Peak intensity 0.6 cd/lm LEDs/each optic 1 Light colour White Required components:</p>		
<p>LUMILEDS</p> <p>LED LUXEON A FWHM / FWTM 75.0° / 138.0° Efficiency 91 % Peak intensity 0.5 cd/lm LEDs/each optic 1 Light colour White Required components:</p>		
<p>LUMILEDS</p> <p>LED LUXEON R FWHM / FWTM 75.0° / 136.7° Efficiency 89 % Peak intensity 0.6 cd/lm LEDs/each optic 1 Light colour White Required components:</p>		
<p>LUMILEDS</p> <p>LED LUXEON Rebel FWHM / FWTM 72.0° / 131.0° Efficiency 90 % Peak intensity 0.6 cd/lm LEDs/each optic 1 Light colour White Required components:</p>		

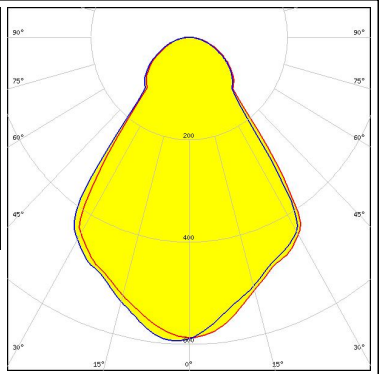

PHOTOMETRIC DATA (MEASURED):

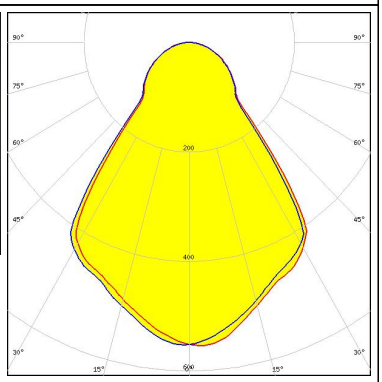
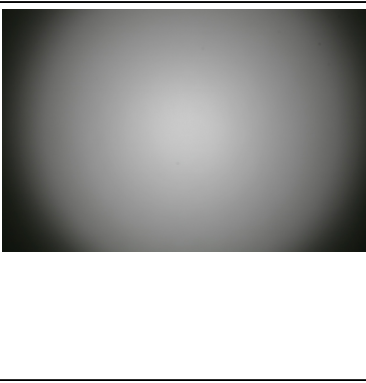
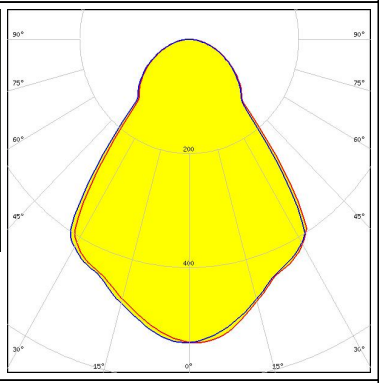
<p>LUMILEDS</p> <p>LED LUXEON Rebel ES</p> <p>FWHM / FWTM 74.0° / 137.0°</p> <p>Efficiency 89 %</p> <p>Peak intensity 0.6 cd/lm</p> <p>LEDs/each optic 1</p> <p>Light colour White</p> <p>Required components:</p>		
<p>LUMILEDS</p> <p>LED LUXEON T</p> <p>FWHM / FWTM 75.0° / 137.0°</p> <p>Efficiency 89 %</p> <p>Peak intensity 0.5 cd/lm</p> <p>LEDs/each optic 1</p> <p>Light colour White</p> <p>Required components:</p>		
<p>LUMILEDS</p> <p>LED LUXEON TX</p> <p>FWHM / FWTM 81.0° / 151.0°</p> <p>Efficiency 90 %</p> <p>Peak intensity 0.5 cd/lm</p> <p>LEDs/each optic 1</p> <p>Light colour White</p> <p>Required components:</p>		
<p>NICHIA</p> <p>LED NCSxx19A</p> <p>FWHM / FWTM 72.0° / 132.0°</p> <p>Efficiency 90 %</p> <p>Peak intensity 0.6 cd/lm</p> <p>LEDs/each optic 1</p> <p>Light colour White</p> <p>Required components:</p>		

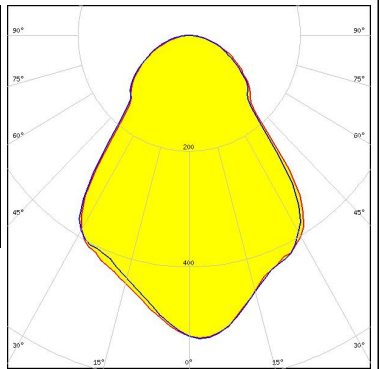
PHOTOMETRIC DATA (MEASURED):

<p>NICHIA</p> <p>LED NF2x757A FWHM / FWTM 72.0° / 135.0° Efficiency 92 % Peak intensity 0.6 cd/lm LEDs/each optic 1 Light colour White Required components:</p>		
<p>NICHIA</p> <p>LED NVSxx19A FWHM / FWTM 74.0° / 136.0° Efficiency 90 % Peak intensity 0.6 cd/lm LEDs/each optic 1 Light colour White Required components:</p>		
<p>NICHIA</p> <p>LED NVSxx19B/NVSxx19C FWHM / FWTM 74.0° / 139.0° Efficiency 89 % Peak intensity 0.5 cd/lm LEDs/each optic 1 Light colour White Required components:</p>		
<p>OSRAM <small>Opto Semiconductors</small></p> <p>LED Duris S5 (2 chip) FWHM / FWTM 76.0° / 144.0° Efficiency 91 % Peak intensity 0.5 cd/lm LEDs/each optic 1 Light colour White Required components:</p>		

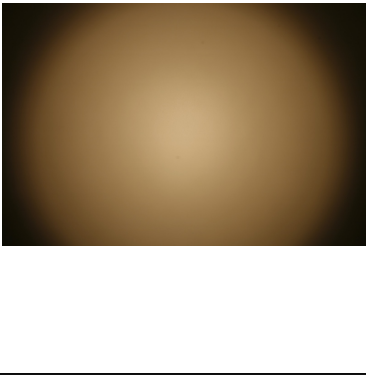
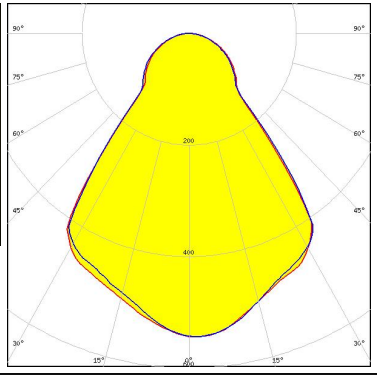
PHOTOMETRIC DATA (MEASURED):

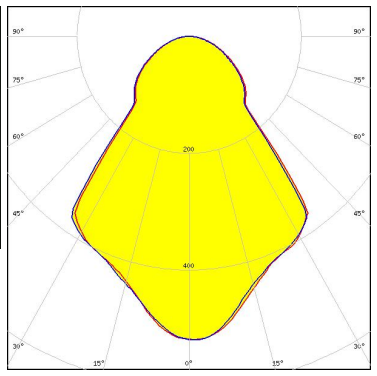
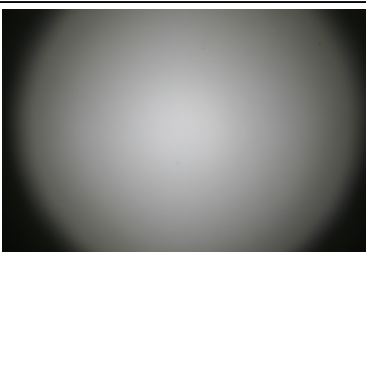
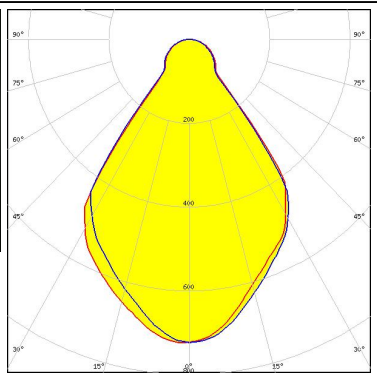
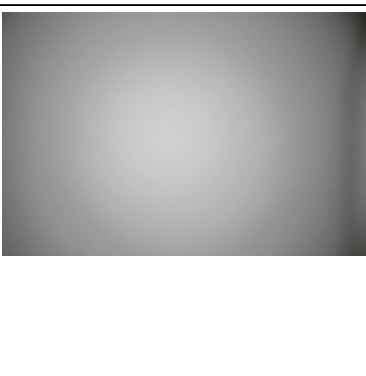
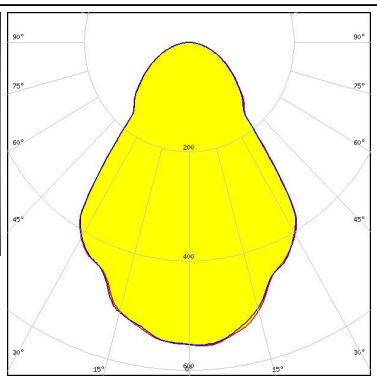
<p>OSRAM Opto Semiconductors</p> <p>LED OSLON Square EC</p> <p>FWHM / FWTM 75.0° / 138.0°</p> <p>Efficiency 91 %</p> <p>Peak intensity 0.5 cd/lm</p> <p>LEDs/each optic 1</p> <p>Light colour White</p> <p>Required components:</p>		
<p>OSRAM Opto Semiconductors</p> <p>LED OSLON SSL 150</p> <p>FWHM / FWTM 75.0° / 140.0°</p> <p>Efficiency 88 %</p> <p>Peak intensity 0.5 cd/lm</p> <p>LEDs/each optic 1</p> <p>Light colour White</p> <p>Required components:</p>		
<p>OSRAM Opto Semiconductors</p> <p>LED OSLON SSL 80</p> <p>FWHM / FWTM 71.0° / 108.0°</p> <p>Efficiency 91 %</p> <p>Peak intensity 0.7 cd/lm</p> <p>LEDs/each optic 1</p> <p>Light colour White</p> <p>Required components:</p>		
<p>SEOUL SEMICONDUCTOR</p> <p>LED Z8Y15</p> <p>FWHM / FWTM 72.0° / 137.0°</p> <p>Efficiency 90 %</p> <p>Peak intensity 0.6 cd/lm</p> <p>LEDs/each optic 1</p> <p>Light colour White</p> <p>Required components:</p>		

PHOTOMETRIC DATA (MEASURED):

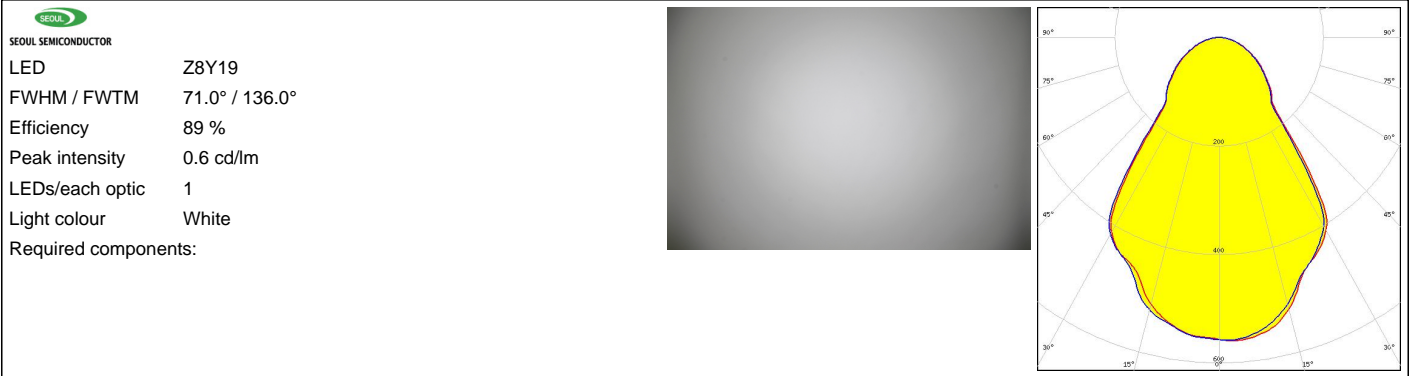

PHOTOMETRIC DATA (SIMULATED):

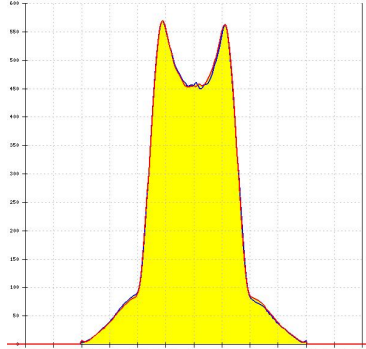
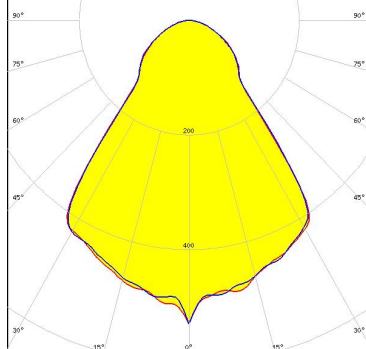
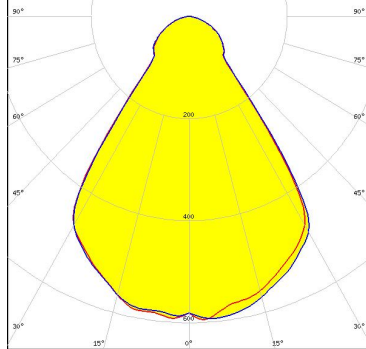
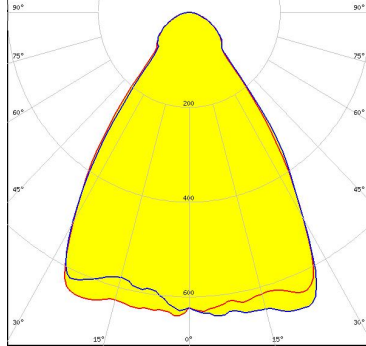
<p>CREE LED</p> <p>LED: XP-G2 HE FWHM / FWTM: 73.0° / 120.0° Efficiency: 86 % Peak intensity: 0.6 cd/lm LEDs/each optic: 1 Light colour: White Required components:</p>	
<p>OSRAM Opto Semiconductors</p> <p>LED: OSCONIQ P 3030 FWHM / FWTM: 74.0° / 134.0° Efficiency: 86 % Peak intensity: 0.5 cd/lm LEDs/each optic: 1 Light colour: White Required components:</p>	
<p>OSRAM Opto Semiconductors</p> <p>LED: OSOLON Black FWHM / FWTM: 71.0° / 125.0° Efficiency: 80 % Peak intensity: 0.6 cd/lm LEDs/each optic: 1 Light colour: White Required components:</p> <p>Protective plate, glass</p>	
<p>OSRAM Opto Semiconductors</p> <p>LED: OSOLON Square CSSRM2/CSSRM3 FWHM / FWTM: 65.0° / 116.0° Efficiency: 94 % Peak intensity: 0.7 cd/lm LEDs/each optic: 1 Light colour: White Required components:</p>	

PHOTOMETRIC DATA (SIMULATED):

SAMSUNG

LED LH351B
FWHM / FWTM 78.0° / 138.0°
Efficiency 87 %
Peak intensity 0.5 cd/lm
LEDs/each optic 1
Light colour White
Required components:

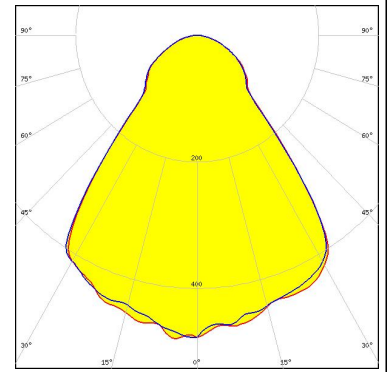

SAMSUNG

LED LH351C
FWHM / FWTM 79.0° / 140.0°
Efficiency 86 %
Peak intensity 0.5 cd/lm
LEDs/each optic 1
Light colour White
Required components:

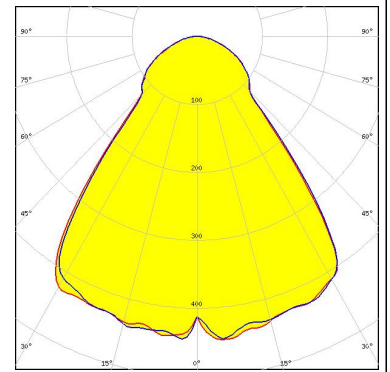

GENERAL INFORMATION:

NOTE: The typical beam angle will be changed by different color, chip size and chip position tolerance. The typical total beam angle is the full angle measured where the luminous intensity is half of the peak value.

MATERIALS:

As part of our continuous research and improvement processes, and to ensure the best possible quality and availability of our products, LEDiL reserves the right to change material grades without notice.

PRODUCT DATA USER AGREEMENT AND DISCLAIMER:

The measured data in the provided downloadable LEDiL Product Datasheets and Mechanical 2D-Drawings is rounded and provided as reference for planning. LEDiL Oy's optical specifications have been verified by conducting performance testing of the products in accordance with the company's quality system. The reported data are averaged results of multiple measurements with typical variation. LEDiL Oy reserves the right to without prior notification make changes and improvements to its products.

LEDiL Oy assumes neither warranty, nor guarantee nor any other liability of any kind for the contents and correctness of the provided data. The provided data has been generated with highest diligence but the provided data may in reality not represent the complete possible variation range of all intrinsic parameters. Therefore, in certain cases a deviation from the provided data could occur.

LEDiL Oy reserves the right to undertake technical changes of its products without further notification which could lead to changes in the provided data. LEDiL Oy assumes no liability of any kind for the possible deviation from any provided data or any other damage resulting from the usage of the provided data.

The user agrees to this disclaimer and user agreement with the download or usage of the provided files.

LEDiL Oy

Joensuunkatu 13
FI-24240 SALO
Finland

LEDiL Inc.

228 West Page Street
Suite D
Sycamore IL 60178
USA

Ledil Optics Technology (Shenzhen) Co., Ltd.

405 , Block B
Casic Motor Building
Shenzhen 518057
P.R.CHINA

Local sales and technical support

[www.ledil.com/
where_to_buy](http://www.ledil.com/where_to_buy)

Shipping locations

Salo, Finland
Hong Kong, China

Distribution Partners

[www.ledil.com/
where_to_buy](http://www.ledil.com/where_to_buy)