

HiTemp ET Series Thermoelectric Cooler

Note: This product is not recommended for new designs.
 This product series has been replaced with the HiTemp ETX Series.
 The recommended replacement is:
 MFG Part Number: 387006901
 Description: OTX19-35-F1N-0612-21-EP-W2.25

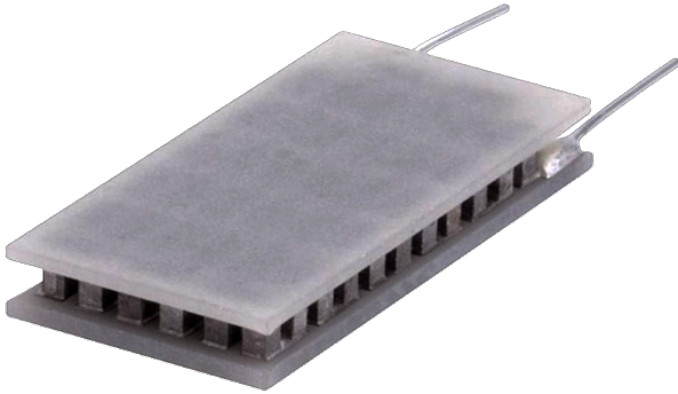

Features

- High-temperature operation
- Reliable solid-state
- No sound or vibration
- Environmentally-friendly
- RoHS-compliant

Applications

- Peltier Cooling for Refrigerated Centrifuges
- Peltier Cooling for Machine Vision
- Thermoelectric Cooling for CMOS Sensors
- Cooling Solutions for Autonomous Systems
- Peltier Cooling for Digital
- Light Processors

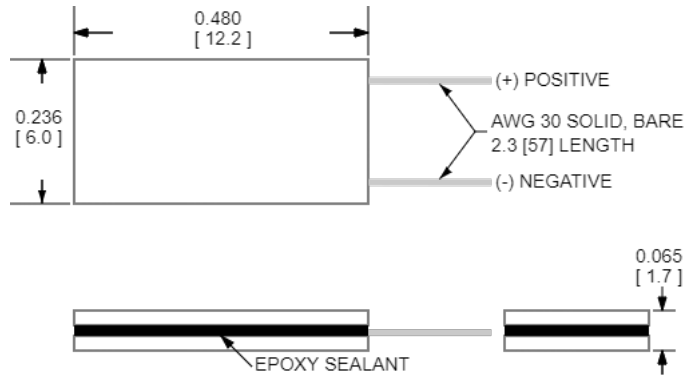

CERAMIC MATERIAL: AlN
 SOLDER CONSTRUCTION: 232°C, SbSn
 INCHES [MM]
 Note: Allow 0.020 in [0.5 mm] around perimeter of the thermoelectric cooler and lead wire attachment to accommodate sealant

ELECTRICAL AND THERMAL PERFORMANCE

Heat Pumped at Cold Side
 Thot = 85 °C

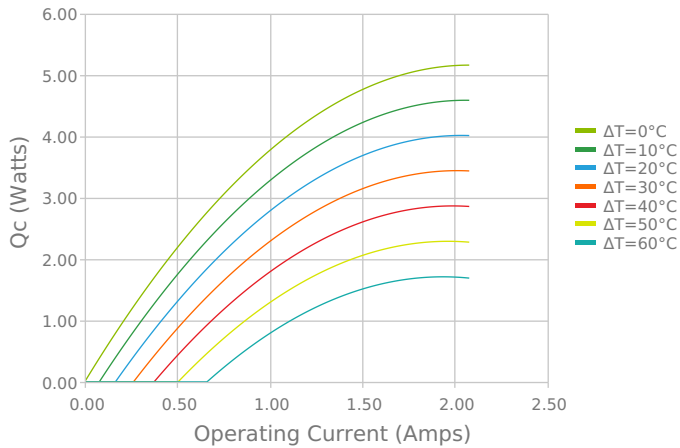

Heat Pumped at Cold Side
 Thot = 85 °C

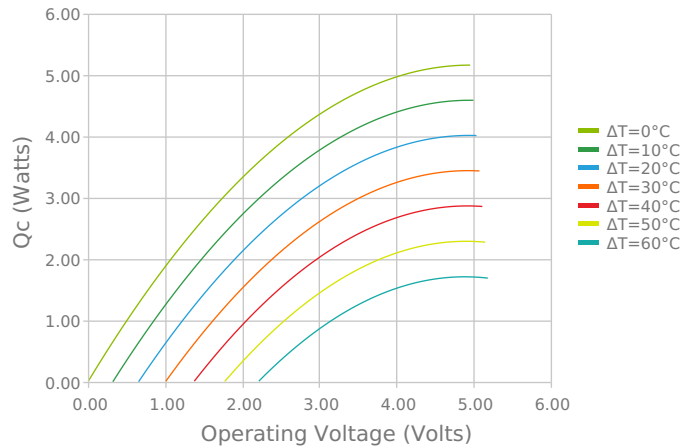

Current vs Voltage (I vs V)
 Thot = 85 °C

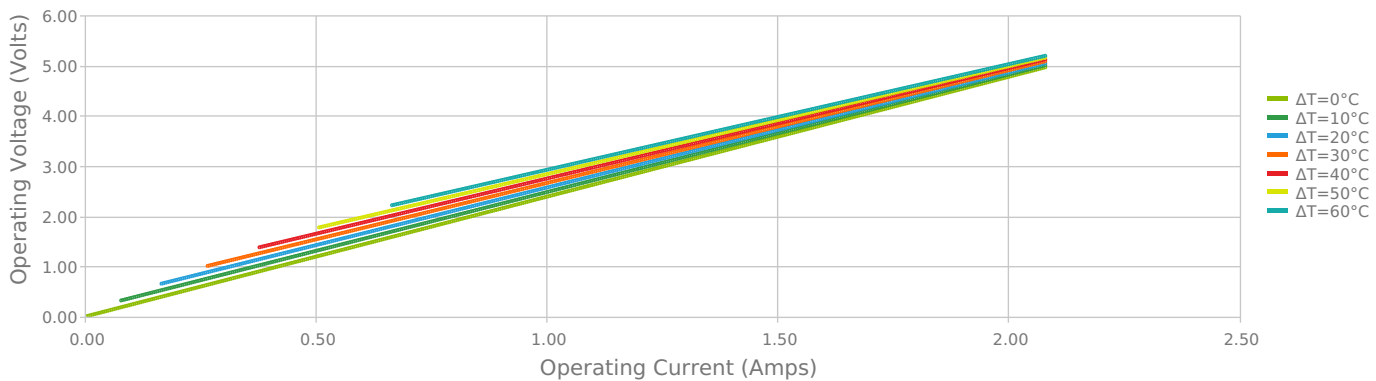

Coefficient of Performance (COP = Qc/Pin)
Thot = 85 °C

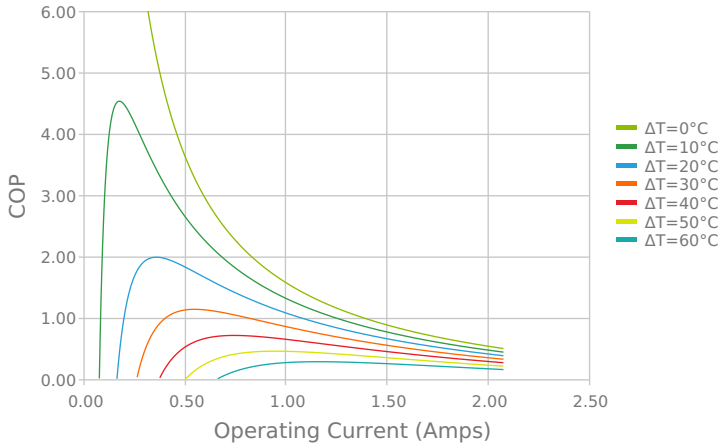

Coefficient of Performance (COP = Qc/Pin)
Thot = 85 °C

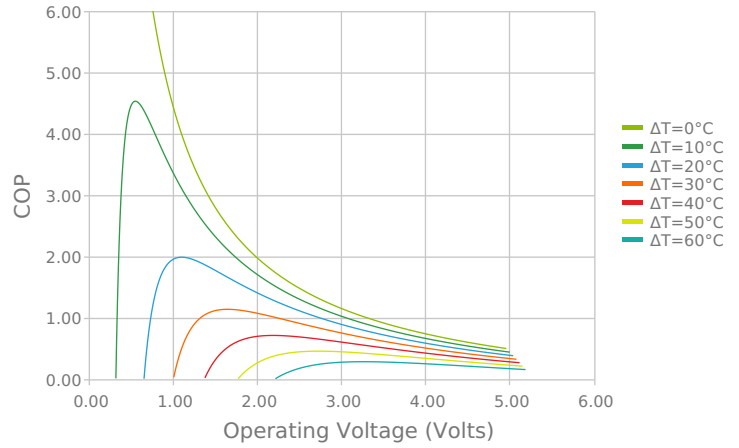

Total Heat Dissipated at Hot Side (Qh=Qc+Pin)
Thot = 85 °C

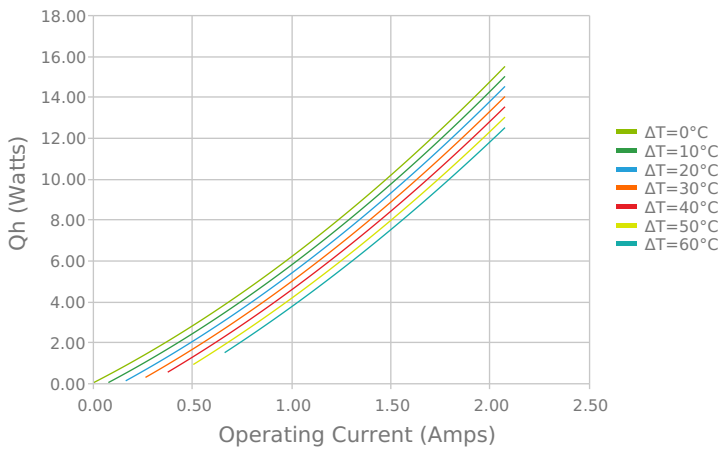

Total Heat Dissipated at Hot Side (Qh=Qc+Pin)
Thot = 85 °C

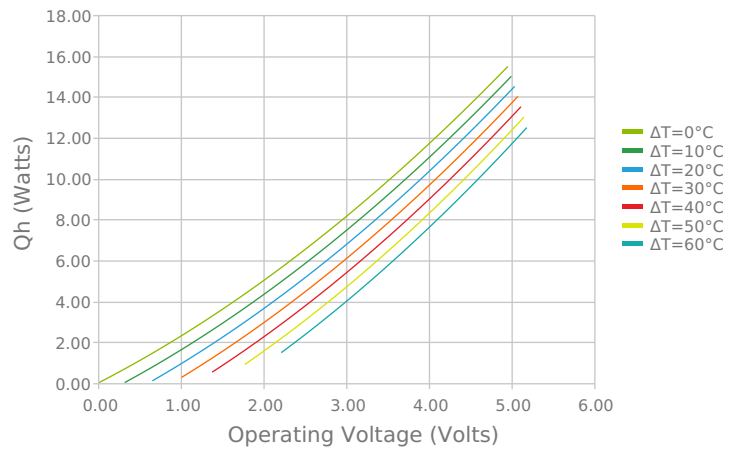

Heat Pumped at Cold Side (Qc)
Thot = 85 °C | Current = 1.6 Amps

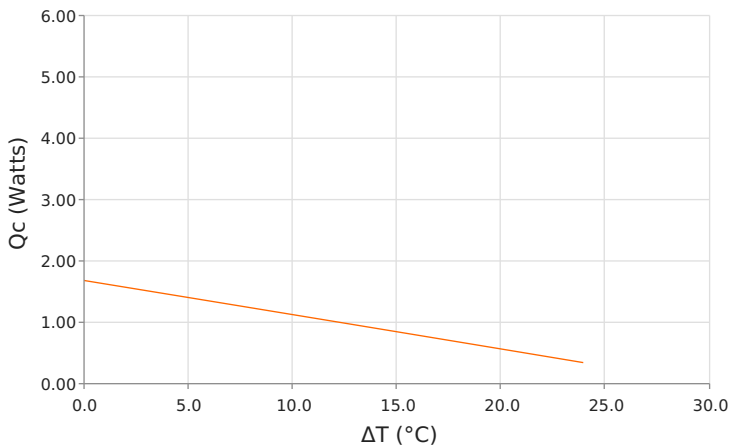

Coefficient of Performance (COP = Qc/Pin)
Thot = 85 °C | Current = 1.6 Amps

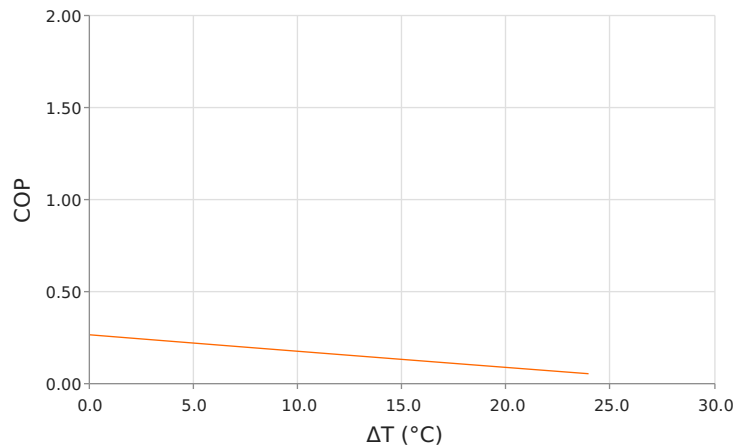

SPECIFICATIONS*

Hot Side Temperature	50.0 °C	85.0 °C	110.0 °C
Qcmax ($\Delta T = 0$)	4.7 Watts	5.2 Watts	5.4 Watts
ΔT_{max} ($Q_c = 0$)	77.9°C	89.3°C	96.2°C
I_{max} (I @ ΔT_{max})	1.9 Amps	1.8 Amps	1.8 Amps
V_{max} (V @ ΔT_{max})	4.2 Volts	4.8 Volts	5.3 Volts
Module Resistance	2.05 Ohms	2.39 Ohms	2.61 Ohms
Max Operating Temperature	150 °C		
Weight	1.0 gram(s)		

* Specifications reflect thermoelectric coefficients updated March 2020

FINISHING OPTIONS

Suffix	Thickness	Flatness / Parallelism	Hot Face	Cold Face	Lead Length
11	1.651 ±0.051 mm 0.065 ± 0.0020 in	0.051 mm / 0.051 mm 0.002 in / 0.002 in	Lapped	Lapped	50.8 mm 2.00 in

SEALING OPTIONS

Suffix	Sealant	Color	Temp Range	Description
EP	Epoxy	Black	-55 to 150°C	Low density syntactic foam epoxy encapsulant

NOTES

1. Max operating temperature: 150°C
2. Do not exceed I_{max} or V_{max} when operating module
3. Reference assembly guidelines for recommended installation

Any information furnished by Laird and its agents, whether in specifications, data sheets, product catalogues or otherwise, is believed to be (but is not warranted as being) accurate and reliable, is provided for information only and does not form part of any contract with Laird. All specifications are subject to change without notice. Laird assumes no responsibility and disclaims all liability for losses or damages resulting from use of or reliance on this information. All Laird products are sold subject to the Laird Terms and Conditions of sale (including Laird's limited warranty) in effect from time to time, a copy of which will be furnished upon request.

© Copyright 2019-2021 Laird Thermal Systems, Inc. All rights reserved. Laird™, the Laird Ring Logo, and Laird Thermal Systems™ are trademarks or registered trademarks of Laird Limited or its subsidiaries.

Date: 01/08/2022