

Board-to-Board Applications up to 20 GHz / 40 GHz

Multiport Mini-Coax Connectors and Cable Assemblies

TEST & MEASUREMENT

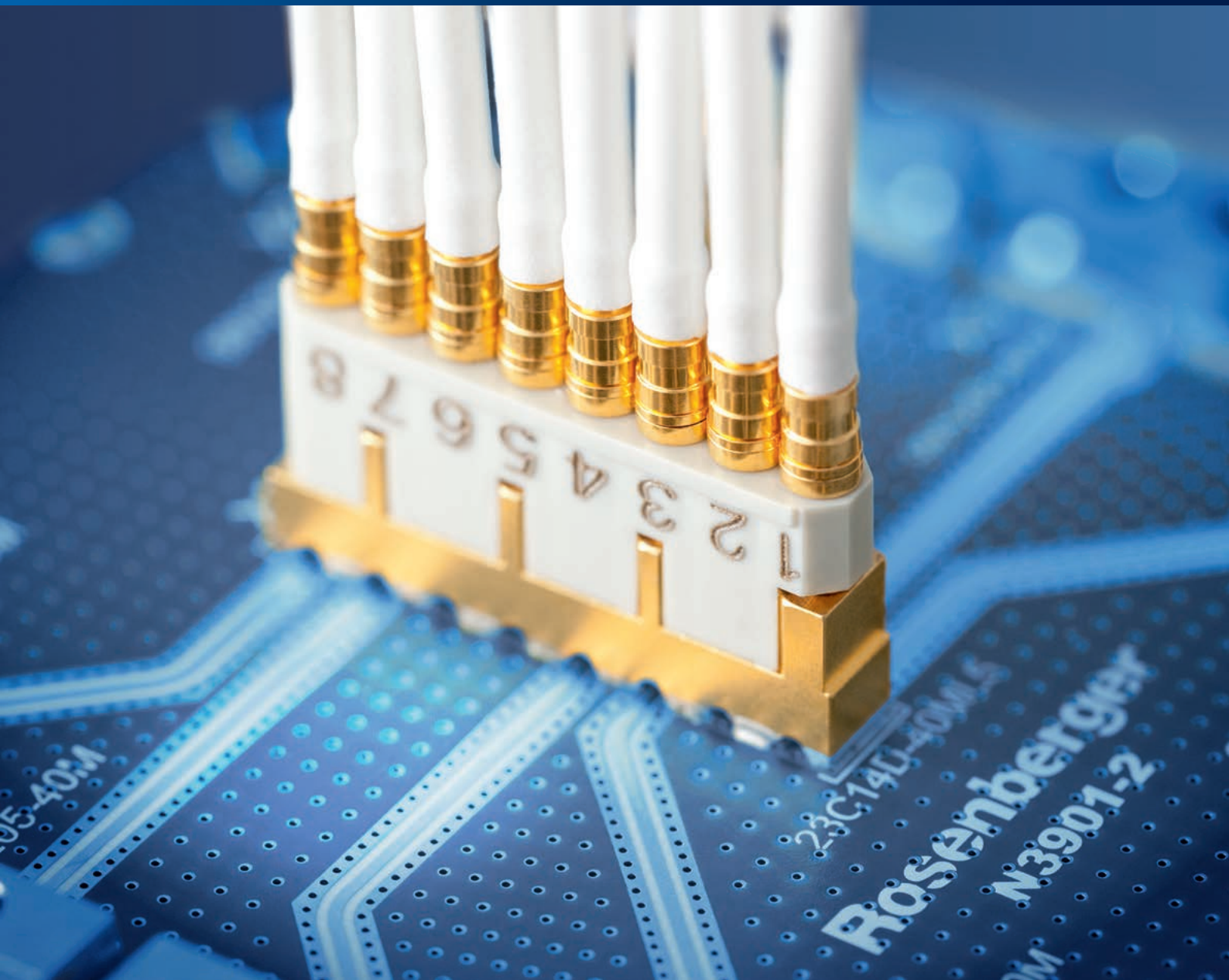

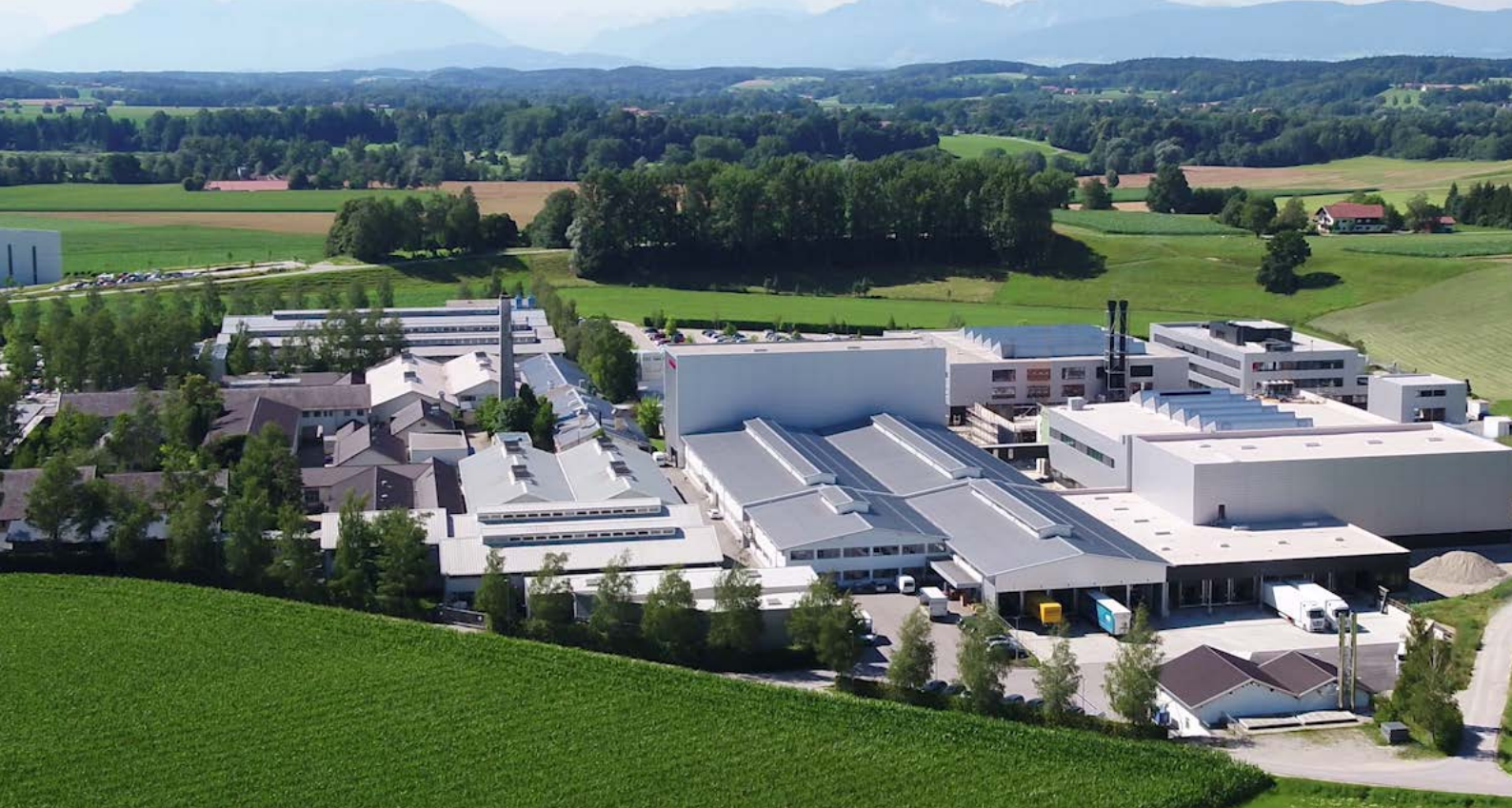

Company Profile

About Rosenberger

Rosenberger, a family owned company, is one of the world's leading manufacturers of impedance-controlled connectivity solutions in high-frequency, high-voltage and fiberoptic technology. Renowned companies in high-tech industries trust the precision and quality of Rosenberger products, e.g. mobile communication networks, data centers, test & measurement industries, automotive electronics, industrial and medical electronics, or aerospace engineering.

Worldwide, the Rosenberger group operates a global network of R&D, manufacturing and assembly locations as well as Rosenberger sales offices in Europe, Asia and North and South America where more than 11,000 employees develop, produce and sell our products.

Test & Measurement

Rosenberger is a dependable and renowned development partner in industrial measurement technology. The fact that we work with leading global companies from the electronic measurement technology field reflects the way that others trust our research and development, our high-quality manufacturing, and not least our customer-orientated "Made in Germany" service. Rosenberger provides customized solutions – cost-optimized and timely – from the initial idea right through to volume production.

Rosenberger develops and produces a comprehensive range of cost-effective, high-quality and high-precision test & measurement products and services – microwave measurements & VNA calibrations, lab and factory testing, semiconductor test applications, PCB connections or network testing.



Contents

| | |
|---|---|
| Company Profile | 2 |
| Multiport Mini-Coax – for 20 GHz and 40 GHz | 4 |
| Interface and Outer Dimensions | 5 |
| Product Portfolio | 6 |

The Rosenberger online catalog contains the current product range with specific details, including data sheets, assembly instructions and panel piercings.

www.rosenberger.com/ok



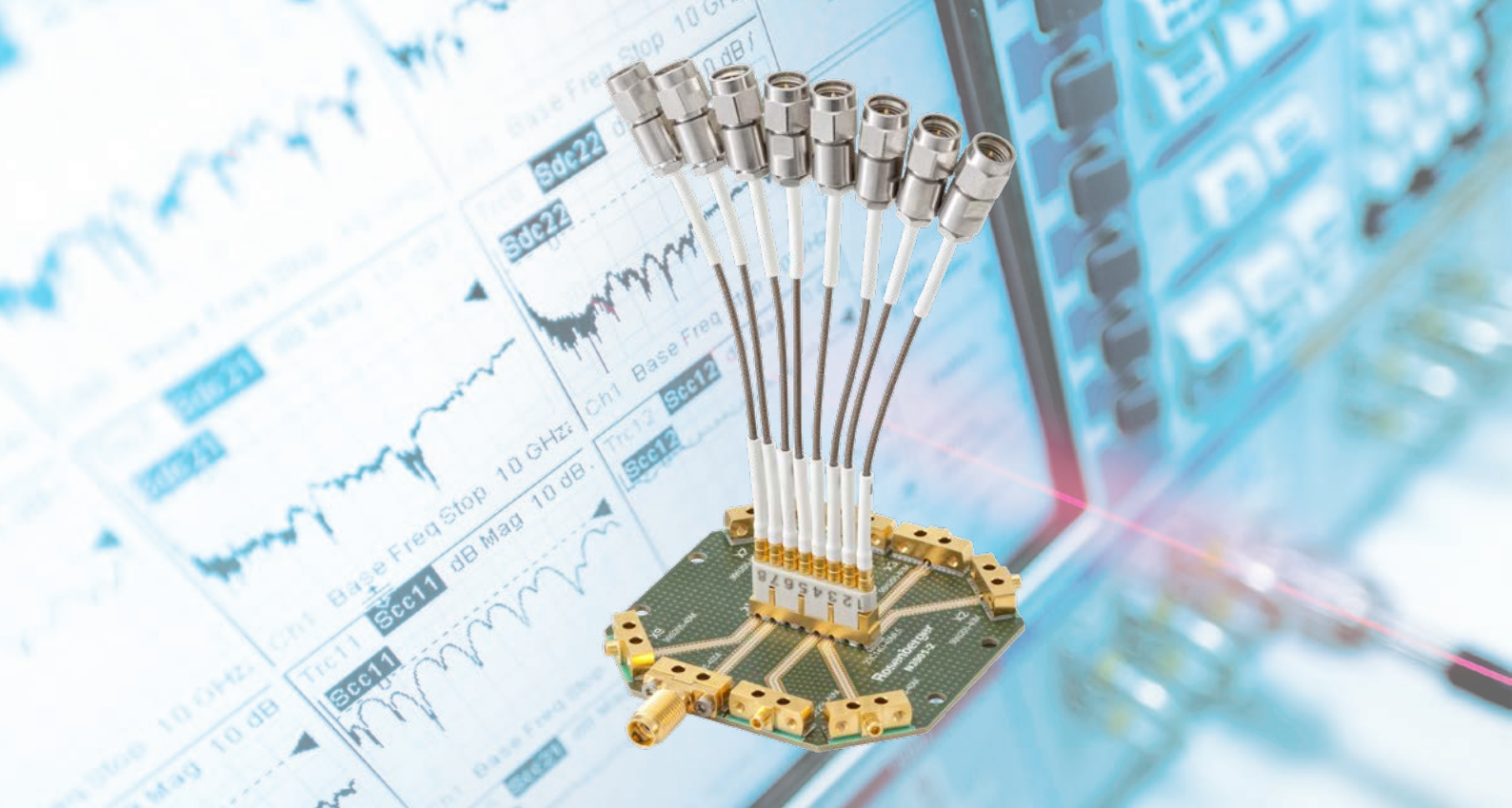

Multiport Mini-Coax – for 20 GHz and 40 GHz

Rosenberger provides a wide range of Multiport Mini-Coax connectors and cable assemblies. To meet the ever challenging technological requirements and increasing demands of the semiconductor test equipment industry, Rosenberger provides Multiport Mini-Coax products for 20 GHz as well as 40 GHz applications.

The revised portfolio includes a variety of pre-assembled cable pairs, affording the customers flexibility when configuring cable assemblies.

The cost-effective, injection moulded housings, to be connected with the PCB connectors, are available with 2, 4, 6 and 8 channels and make possible to mix pre-assembled Mini-Coax cable pairs. Due to the extraction tool mating and demating on site is quick and easy. Customized cable assemblies can be realized according requirements on site.

The pre-assembled cable pairs are available with different configurations and as non-matched pairs as well as pair-matched up to 2 ps maximum delay difference.

Complete cable assemblies including housing, also with phase matching over all channels, are still available on request.

The product range consists of PCB connectors, adaptors, terminations, cable assemblies and tools. The interface dimensions are based on Rosenberger standard Mini-Coax connectors. Board-to-board connections can be applied in very limited spaces with the advantages of coaxial shielding.

Product Features

- High packing density, small dimensions (3 mm pitch), mating cycles ≥ 500
- Pre-assembled cable pairs with pair-matching up to 2 ps
- Common and differential mode possible
- High electrical and mechanical stability, very flexible cables
- Tilt protection – shape of housings ensures high mechanical stability
- 20 GHz and 40 GHz Multiport Mini-Coax connectors are mechanical compatible to each other

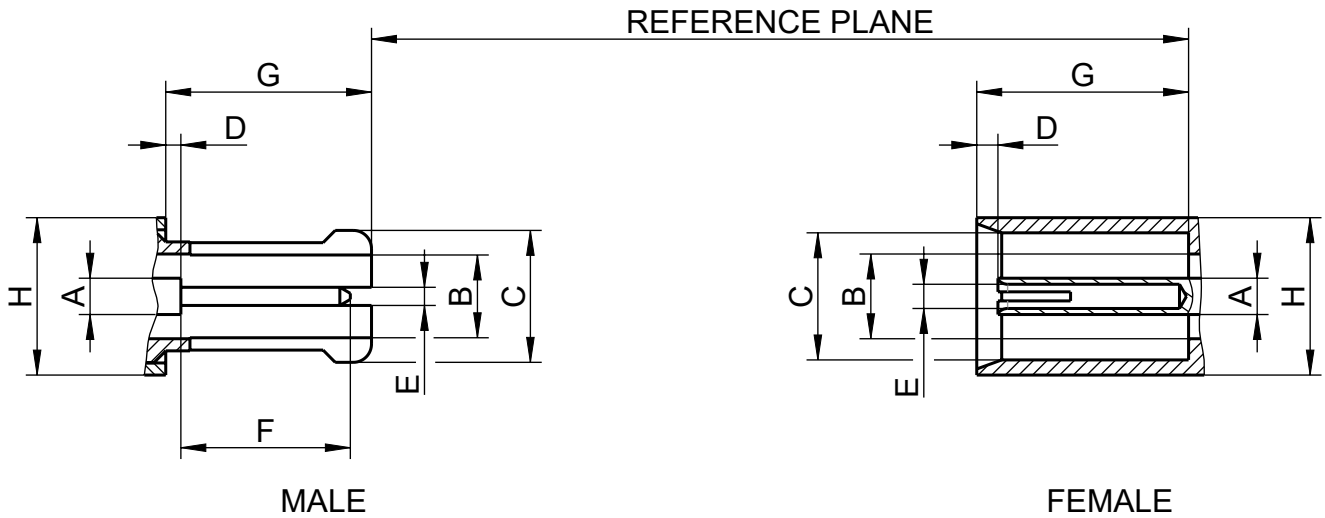

Interface Dimensions Mini-Coax

Code 23

Interface and Outer Dimensions

Mini-Coax

| Dimensions (mm) | Male | | Female | |
|-----------------|-----------|---------|-----------|---------|
| | Minimum | Maximum | Minimum | Maximum |
| A | 0.60 nom. | | 0.60 nom. | |
| B | 1.40 nom. | | 1.40 nom. | |
| C | 1) | | 2.10 | 2.125 |
| D | - | 0.30 | 0.30 | - |
| E | 0.30 | 0.33 | 2) | |
| F | - | 3.10 | - | - |
| G | - | 3.50 | 3.50 | - |
| H | 2.60 nom. | | 2.60 nom. | |

1) Resilient for contact with jack dimensions C

2) Resilient, dimensions to meet electrical and mechanical requirements

Outer Dimensions Multiport Mini-Coax

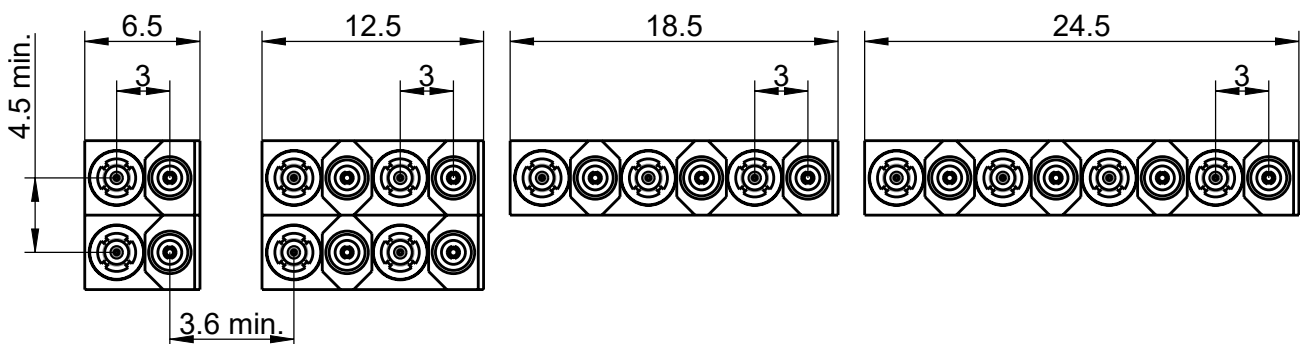

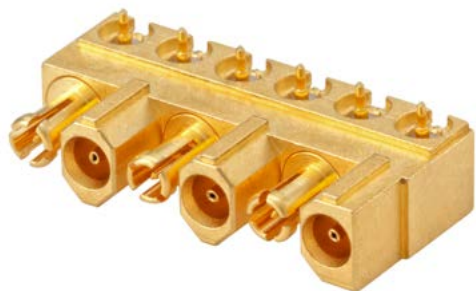
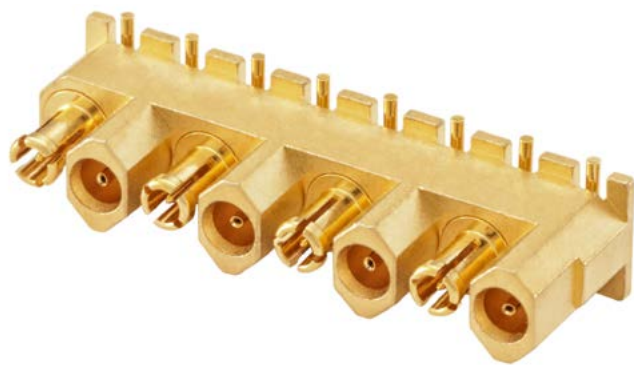

Product Portfolio

Multiport Mini-Coax PCB Connectors up to 20 GHz

Straight Connectors, Feedthrough or SMD

| Rosenberger No. | Channels | Return Loss | |
|-----------------|----------|--|--|
| 23C11F-40ML5 | 2 | For feedthrough ≥ 20 dB, DC to 3 GHz ≥ 16 dB, 3 GHz to 8 GHz | For SMD ≥ 25 dB, DC to 3 GHz ≥ 20 dB, 3 GHz to 6 GHz ≥ 16 dB, 6 GHz to 20 GHz |
| 23C11E-40ML5 | 4 | | |
| 23C11G-40ML5 | 6 | | |
| 23C11D-40ML5 | 8 | | |



Straight Connectors, Solder Pin

| Rosenberger No. | Channels | Return Loss |
|-----------------|----------|---|
| 23C12F-40ML5 | 2 | ≥ 25 dB, DC to 3 GHz ≥ 20 dB, 3 GHz to 6 GHz ≥ 16 dB, 6 GHz to 20 GHz |
| 23C12E-40ML5 | 4 | |
| 23C12G-40ML5 | 6 | |
| 23C12D-40ML5 | 8 | |



Right Angle Connectors, Solder Pin

| Rosenberger No. | Channels | Return Loss |
|-----------------|----------|---|
| 23C21F-40ML5 | 2 | ≥ 25 dB, DC to 3 GHz ≥ 20 dB, 3 GHz to 6 GHz ≥ 16 dB, 6 GHz to 20 GHz |
| 23C21E-40ML5 | 4 | |
| 23C21G-40ML5 | 6 | |
| 23C21D-40ML5 | 8 | |



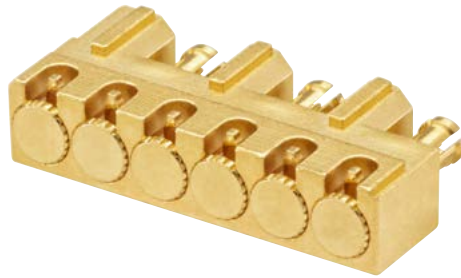
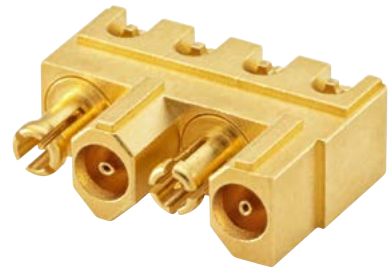
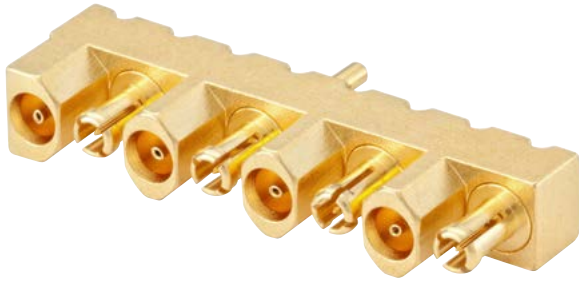

Multiport Mini-Coax PCB Connectors up to 40 GHz

Straight Connectors, SMD

| Rosenberger No. | Channels | Return Loss |
|-----------------|----------|--|
| 23C14F-40ML5 | 2 | ≥ 25 dB, DC to 3 GHz ≥ 20 dB, 3 GHz to 6 GHz ≥ 16 dB, 6 GHz to 20 GHz ≥ 12 dB, 20 GHz to 40 GHz |
| 23C14E-40ML5 | 4 | |
| 23C14G-40ML5 | 6 | |
| 23C14D-40ML5 | 8 | |



Right Angle Connectors, SMD

| Rosenberger No. | Channels | Return Loss |
|-----------------|----------|--|
| 23C25F-40ML5 | 2 | ≥ 25 dB, DC to 3 GHz ≥ 20 dB, 3 GHz to 6 GHz ≥ 16 dB, 6 GHz to 20 GHz ≥ 12 dB, 20 GHz to 40 GHz |
| 23C25E-40ML5 | 4 | |
| 23C25G-40ML5 | 6 | |
| 23C25D-40ML5 | 8 | |



For specific details refer to the technical data sheets in our online catalog.
www.rosenberger.com/ok



Product Portfolio

Tools

| Rosenberger No. | Remarks |
|-----------------|--|
| 23W100-000 | Extraction tool for Multiport Mini-Coax cable lines and terminations |
| 23W100-001 | Replacement sleeve for 23W100-000 |
| 23W101-000 | Extraction tool for Multiport Mini-Coax housings |

Housings

| Rosenberger No. | Channels |
|-----------------|----------|
| 23Z121-008 | 2 |
| 23Z121-007 | 4 |
| 23Z121-004 | 6 |
| 23Z121-005 | 8 |

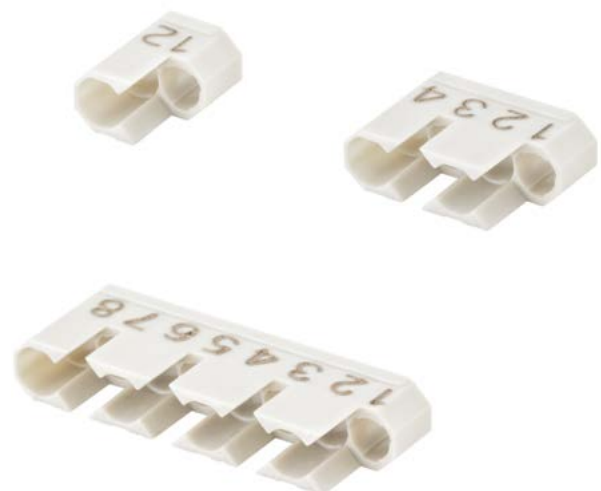



Adaptors

| Rosenberger No. | Interface ¹⁾ | Return Loss |
|-----------------|---|---|
| 02S123-S00S3 | RPC-2.92 male – Mini-Coax male 40 GHz | ≥ 26 dB, DC to 18 GHz ≥ 21 dB, 18 GHz to 26.5 GHz ≥ 15 dB, 26.5 GHz to 40 GHz |
| 02S123-K00S3 | RPC-2.92 male – Mini-Coax female 40 GHz | |
| 02K123-K00S3 | RPC-2.92 female – Mini-Coax female 40 GHz | |
| 02K123-S00S3 | RPC-2.92 female – Mini-Coax male 40 GHz | |

1) 40 GHz Mini-Coax is mateable with 20 GHz Mini-Coax

Terminations ²⁾

| Rosenberger No. | Interface | Return Loss |
|-----------------|------------------|--|
| 23S15A-010E4 | Mini-Coax male | ≥ 26 dB, DC to 4 GHz ≥ 18 dB, 4 GHz to 10 GHz |
| 23K15A-010E4 | Mini-Coax female | |

2) Terminations could be assembled in Multiport Housings



Product Portfolio

Pre-Assembled Cable Pairs

The Rosenberger Multiport Mini-Coax connector system enables cable assembly configurations for customer-specific test applications. The cable set can be configured by the customer according to his requirements.

Each pre-assembled cable pair is available non-matched or pair matched up to 2 ps.

The necessary housing has to be ordered separately.

Customer-specific solutions and complete cable assemblies are available on request.

For example:

If a pre-assembled cable pair with Mini-Coax straight, RPC-2.92 male, 300 mm length and 2 ps pair matching is needed, the part number will be L99-A0483-300-2ps.



| Rosenberger No. ¹⁾ | Connectors Side 1 | Connectors Side 2 | Return Loss |
|-------------------------------|--|--|--|
| L99-A0479-XXX-Y | Mini-Coax male Mini-Coax female | Mini-Coax male Mini-Coax female | ≥ 16 dB, DC to 20 GHz ≥ 10 dB, 20 GHz to 40 GHz |
| L99-A0480-XXX-Y | Mini-Coax male Mini-Coax female | Mini-Coax female Mini-Coax male | ≥ 16 dB, DC to 20 GHz ≥ 10 dB, 20 GHz to 40 GHz |
| L99-A0481-XXX-Y | Mini-Coax male Mini-Coax female | SMA male | ≥ 16 dB, DC to 20 GHz |
| L99-A0482-XXX-Y | Mini-Coax male Mini-Coax female | SMA female | ≥ 14 dB, DC to 20 GHz |
| L99-A0483-XXX-Y | Mini-Coax male Mini-Coax female | RPC-2.92 male | ≥ 16 dB, DC to 20 GHz ≥ 10 dB, 20 GHz to 40 GHz |
| L99-A0484-XXX-Y | Mini-Coax male Mini-Coax female | RPC-2.92 female | ≥ 16 dB, DC to 20 GHz ≥ 10 dB, 20 GHz to 40 GHz |
| L99-A0485-XXX-Y | Mini-Coax male Mini-Coax female | SMP female | ≥ 16 dB, DC to 20 GHz ≥ 10 dB, 20 GHz to 40 GHz |
| L99-A0486-XXX-Y | Mini-Coax male Mini-Coax female | SMP female, right angle | ≥ 16 dB, DC to 20 GHz ≥ 10 dB, 20 GHz to 26.5 GHz |
| L99-A0487-XXX-Y | Mini-Coax male Mini-Coax female | Mini-SMP female | ≥ 14 dB, DC to 20 GHz ≥ 10 dB, 20 GHz to 40 GHz |
| L99-A0488-XXX-Y | Mini-Coax male, right angle Mini-Coax female, right angle | Mini-Coax male, right angle Mini-Coax female, right angle | ≥ 11 dB, DC to 12 GHz |
| L99-A0489-XXX-Y | Mini-Coax male, right angle Mini-Coax female, right angle | Mini-Coax female, right angle Mini-Coax male, right angle | ≥ 11 dB, DC to 12 GHz |
| L99-A0490-XXX-Y | Mini-Coax male, right angle Mini-Coax female, right angle | SMA male | ≥ 14 dB, DC to 12 GHz |
| L99-A0491-XXX-Y | Mini-Coax male, right angle Mini-Coax female, right angle | SMP female | ≥ 12 dB, DC to 12 GHz |

1) XXX: Please fill in the requested length. Standard = 300 mm

Y: Please fill in the requested phase matching (non or 2ps). Standard = non



Website

For more information refer to our website:
www.rosenberger.com/t&m

Rosenberger

Rosenberger Hochfrequenztechnik GmbH & Co. KG

Hauptstraße 1 | 83413 Fridolfing

P.O. Box 1260 | 84526 Tittmoning

Germany

Phone +49 8684 18-0

info@rosenberger.com

www.rosenberger.com

Certified by IATF 16949 · DIN EN 9100 · ISO 9001 · ISO 14001

Order No.

pA 195923 · Info310MultiFlyEN

2000/2020

Rosenberger® is a registered trademark of Rosenberger Hochfrequenztechnik GmbH & Co. KG.
All rights reserved.

© Rosenberger 2020