

## Specification Sheet

Part Number: 151-02035

One-piece ratchet closure allows for easy installation during pre- or final assembly.

Easy release feature simplifies quick adjustments and maintenance.

Impact modified, heat and UV stabilized PA66 provides long-term durability, indoors and out.

Stainless-steel mounting plate tolerates high torque and provides superior corrosion resistance against chemicals, salt spray and contact with dissimilar metals.

Angled mounting plates are ideal for stacking RPCs or for avoiding obstructions or heat sources.

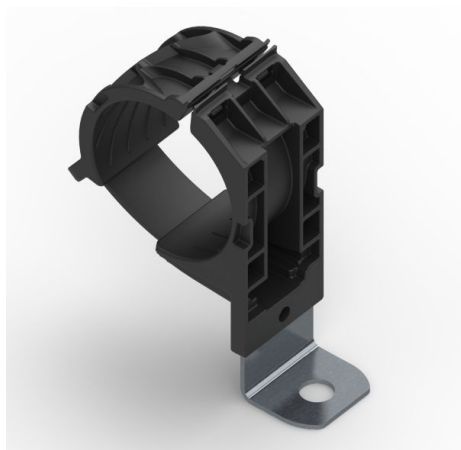

Ratchet P-Clamp, 1.38 - 2.01" Bundle Dia, 90° Short, 0.51" Hole Dia, PA66HIRHSUV/SS304, Black, 160/ctn

<b>Article Number</b>	151-02035
<b>Type</b>	RCD90SM12SS
<b>Color</b>	Black (BK)
<b>Quantity Per</b>	carton

<b>Product Description</b>	The Ratchet P-Clamp family offers versatility when managing wires, cables and hoses. The robust design and durable materials make it ideal for heavy duty applications, both indoors and out. The one-piece adjustable clamp can be closed by hand to the desired diameter. The release feature provides easy and nondestructive removal of cables simply by using a flat-head screwdriver. This nondestructive release allows the clamp to be reused without removing or replacing any bolts or screws.
<b>Short Description</b>	Ratchet P-Clamp, 1.38 - 2.01" Bundle Dia, 90° Short, 0.51" Hole Dia, PA66HIRHSUV/SS304, Black, 160/ctn
<b>Global Part Name</b>	RCD90SM12SS-PA66HIRHSUV/SS304-BK
<b>Minimum Tensile Strength (Imperial)</b>	100.0
<b>Minimum Tensile Strength (Metric)</b>	445.0
<b>Length L (Imperial)</b>	6.58
<b>Length L (Metric)</b>	167.2
<b>Fixation Method</b>	Screw Mounting
<b>Variant</b>	Short
<b>Width W (Imperial)</b>	1.37
<b>Width W (Metric)</b>	34.9
<b>Bundle Diameter Min (Imperial)</b>	1.42
<b>Bundle Diameter Min (Metric)</b>	36.0

<b>Bundle Diameter Max (Imperial)</b>	2.0
<b>Bundle Diameter Max (Metric)</b>	51.0
<b>Cable Tie Width Max (Imperial)</b>	0.52
<b>Cable Tie Width Max (Metric)</b>	13.2
<b>Mounting Hole Diameter D (Imperial)</b>	0.510
<b>Mounting Hole Diameter D (Metric)</b>	12.95 mm
<b>Mounting Hole Diameter D Max (Metric)</b>	12.95
<b>Stud Diameter (Metric)</b>	M12
<b>Mounting Hole Centers (Imperial)</b>	1.67
<b>Material</b>	Stainless Steel (SS304) Polyamide 6.6 high impact modified, heat and UV stabilized (PA66HIRHSUV)
<b>Material Shortcut</b>	PA66HIRHSUV SS304
<b>Flammability</b>	UL 94 HB
<b>Halogen Free</b>	Yes
<b>UV Resistant (Yes/No)</b>	Yes
<b>Operating Temperature</b>	-40°F to +221°F (-40°C to +105°C)

**ROHS Compliant** Yes

**UL Listed (US and Canada)** Yes

**UL Listed (US)** Yes

**Package Quantity (Imperial)** 160

**Package Quantity (Metric)** 160

**Customs Number** 3926909988