

4840 N

# AC axial compact fan



## ebm-papst St. Georgen GmbH & Co. KG

Hermann-Papst-Str. 1

D-78112 St. Georgen

Phone +49 (0) 7724 81-0

Fax +49 (0) 7724 81-1309

info2@de.ebmpapst.com

www.ebmpapst.com

## Nominal data

Type	4840 N	
Phase		1~
Nominal voltage	VAC	115
Frequency	Hz	60
Speed (rpm)	min <sup>-1</sup>	1650
Power consumption	W	10.0
Min. ambient temperature	°C	-10
Max. ambient temperature	°C	75
Air flow	m <sup>3</sup> /h	85
Sound power level	B	4.1
Sound pressure level	dB(A)	26

ml = Max. load · me = Max. efficiency · fa = Free air · cs = Customer specification · ce = Customer equipment  
Subject to change



**Technical description**

<b>Weight</b>	0.550 kg
<b>Dimensions</b>	119 x 119 x 38 mm
<b>Impeller material</b>	Sheet steel, painted black
<b>Housing material</b>	Die-cast aluminum
<b>Airflow direction</b>	Exhaust over struts
<b>Direction of rotation</b>	Clockwise, viewed toward rotor
<b>Storage</b>	Sintec sleeve bearing
<b>Service life L10 at 40 °C</b>	57500 h
<b>Service life L10 at maximum temperature</b>	25000 h
<b>Cable</b>	2 flat plugs 3.0 x 0.5 mm. Housing with grounding lugs with M4 and UNC thread.
<b>Motor protection</b>	Protected from overload by impedance protection
<b>Approval</b>	VDE, CSA, UL, CE
<b>Option</b>	Versions with reinforced mounting flanges and exposed external leads.

## Product drawing

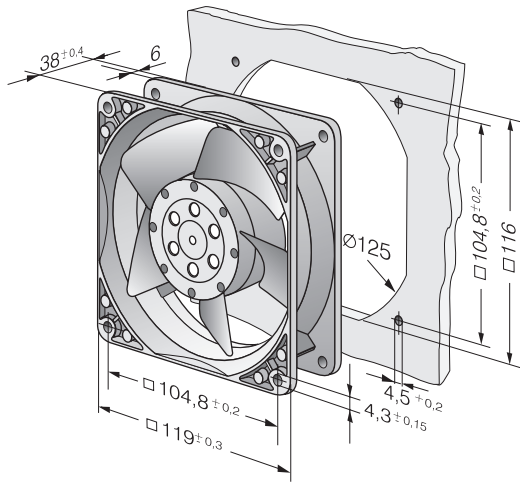

## Curves: Air performance

