

**Tunnel Series Thermoelectric Cooler Assembly**

The AAT-055-24-22 is a thermoelectric based air conditioner designed to temperature control small chambers used in analytical and medical diagnostic instruments. The unique design offers premium fans pushing air across-high density heat sinks to minimize the number of air flow paths required to operate. The design utilizes custom thermoelectric modules to maximize cooling capacity with a high coefficient of performance. Moisture resistant insulation is used to keep condensation from penetrating the thermoelectric module cavity. The unit operates on DC and is designed for an indoor lab use environment. It has a maximum  $Q_c$  of 56 Watts when  $\Delta T = 0$  and a maximum  $\Delta T$  of 40 °C at  $Q_c = 0$ .



**Features**

- Compact design
- Precise temperature control
- Reliable solid-state operation
- DC operation
- RoHS-compliant

**Applications**

- Thermoelectric Coolers and Assemblies for Medical Applications
- Liquid Cooling Options for PET and SPECT Scanners
- Peltier Cooling for Refrigerated Centrifuges
- High-Performance Liquid Chromatography (HPLC)
- Thermal Management Solutions for Beverage Cooling
- Heating and Cooling for Liquid Chromatography Systems

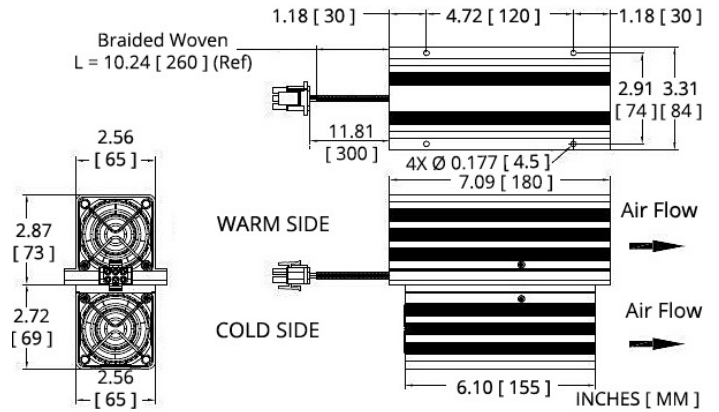

**ELECTRICAL AND THERMAL PERFORMANCE**

Heat Pumped at Cold Side ( $Q_c$ )  
 Tambient = 35°C | Tcontrol = 20°C

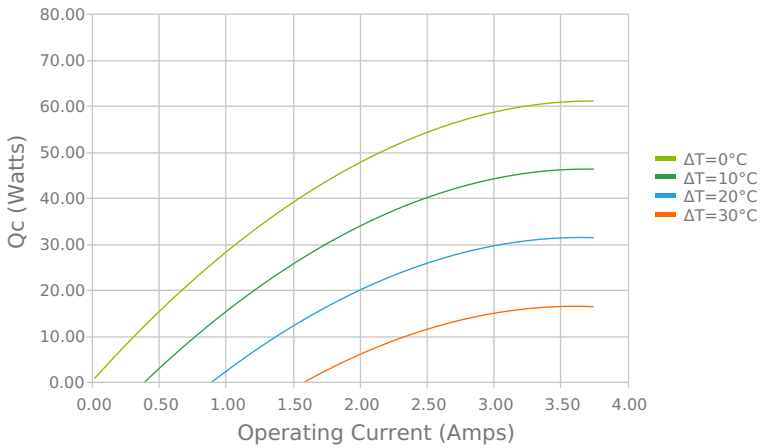

Heat Pumped at Cold Side ( $Q_c$ )  
 Tambient = 35°C | Tcontrol = 20°C

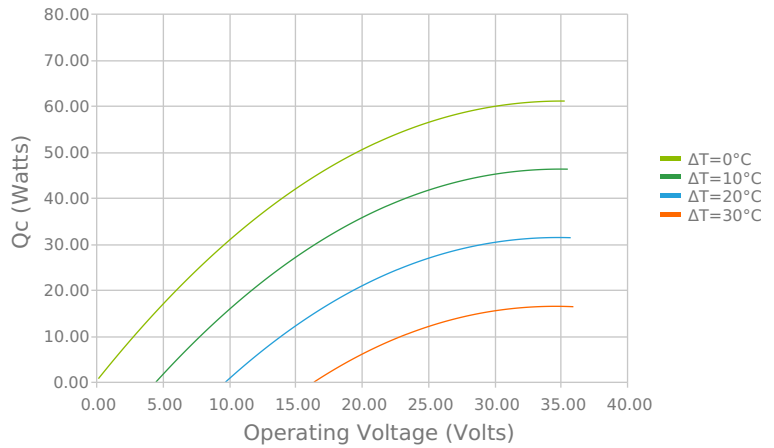

Coefficient of Performance (COP = Qc/Pin)  
 Tambient = 35°C | Tcontrol = 20°C

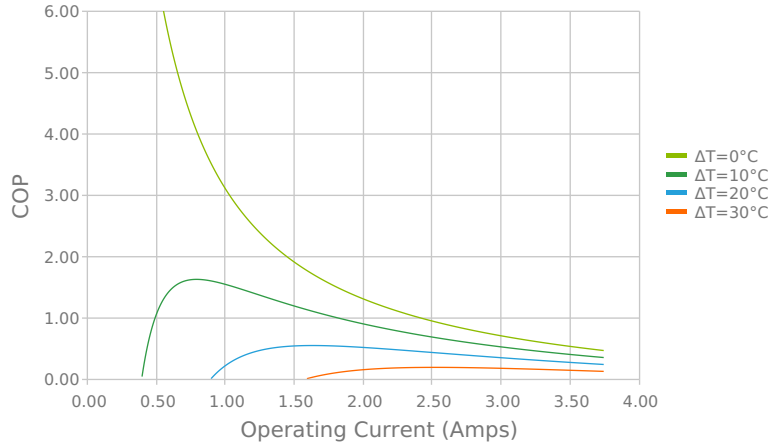

Coefficient of Performance (COP = Qc/Pin)  
 Tambient = 35°C | Tcontrol = 20°C

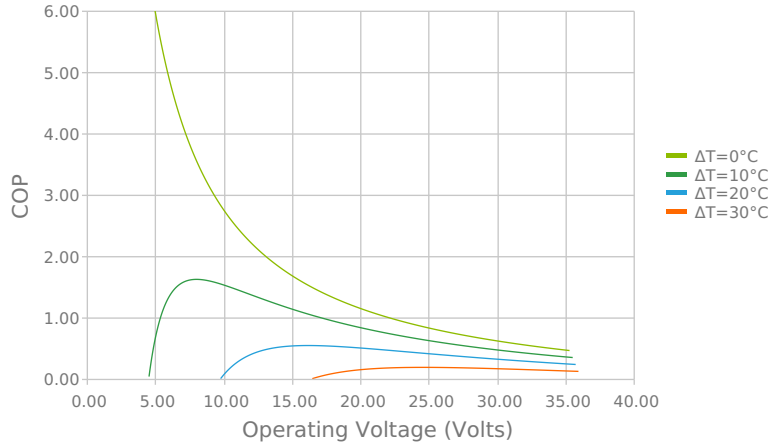

Total Heat Dissipated at Hot Side (Qh=Qc+Pin)  
 Tambient = 35°C | Tcontrol = 20°C

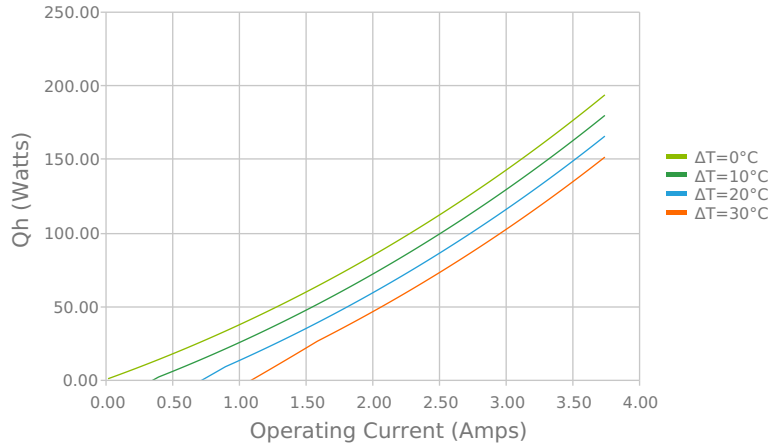

Total Heat Dissipated at Hot Side (Qh=Qc+Pin)  
 Tambient = 35°C | Tcontrol = 20°C

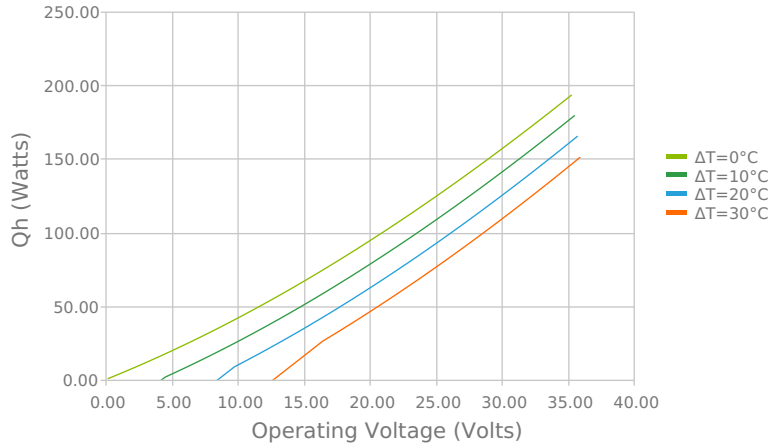

Heat Pumped at Cold Side (Qc)  
 Voperating = 24.01 Volts | Ioperating = 2.61 Amps

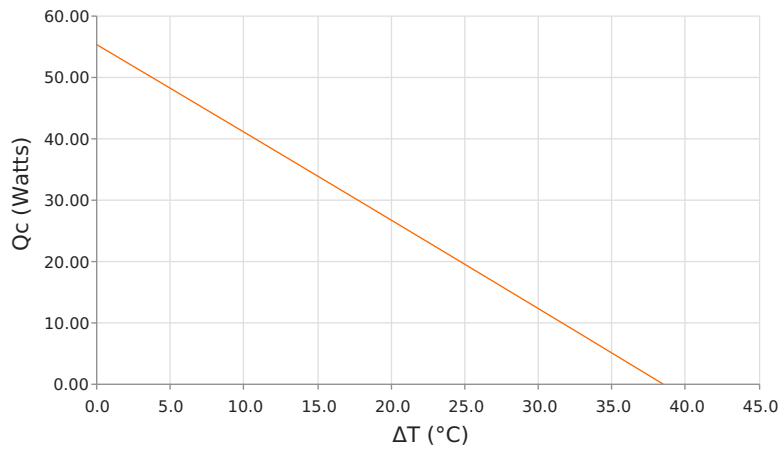

Coefficient of Performance (COP = Qc/Pin)  
 Voperating = 24.01 Volts | Ioperating = 2.61 Amps

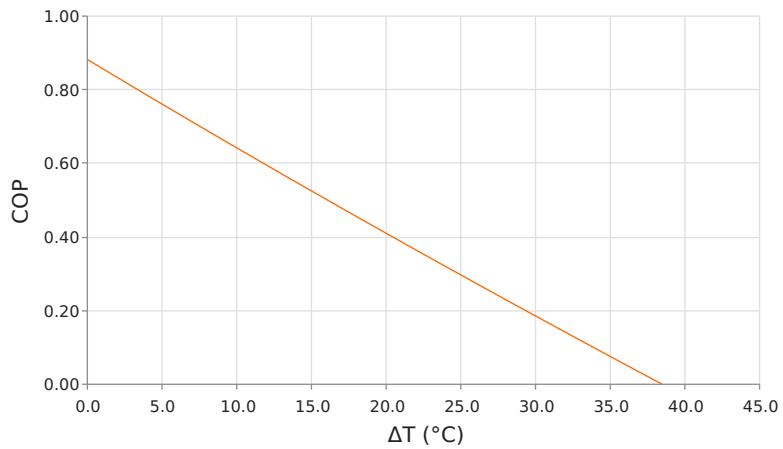

## SPECIFICATIONS

**Operating Temperature Range**

**Supply Voltage**

**Current Draw**

**Power Supply**

**Performance Tolerance**

**Fan MTBF**

**Weight**

-10°C to 50°C
24.0 VDC nominal / 30.0 VDC maximum
3.1 A running / 3.4 A startup
74.5 Watts
10%
40,000 hours
1.65 kg

## MOUNTING HOLE LOCATION

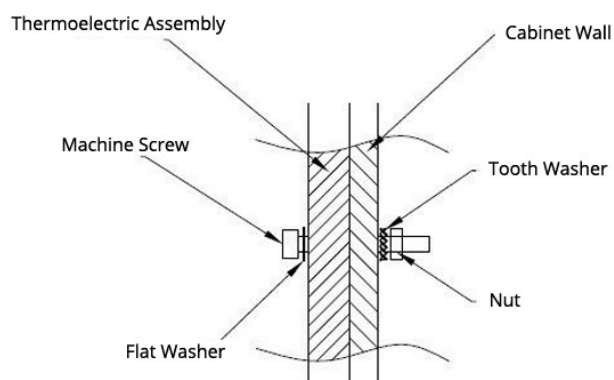

## WIRING SCHEMATIC

PIN #	OBJECT	WIRE SIZE	COLOR	SUPPLIED CONNECTOR		MATING CONNECTOR	
				PLUG	PIN	RECEPTACLE	SOCKET
1	TEM +	AWG #18	Red				
2	TEM -		Black				
3	FAN COLD SIDE +	AWG #20	Purple	TE Connectivity 1-480704-0	TE Connectivity 350547-1	TE Connectivity 1-480705-0	TE Connectivity 350550-1
4	FAN COLD SIDE -		Blue				
5	FAN HOT SIDE +		White				
6	FAN HOT SIDE -		Green				

## NOTES

<sup>1</sup>For indoor use only

<sup>2</sup>Units are generally maintenance free, however occasionally it is recommended to clean the heat sinks and fans of debris. This is best done with compressed air.

Any information furnished by Laird and its agents, whether in specifications, data sheets, product catalogues or otherwise, is believed to be (but is not warranted as being) accurate and reliable, is provided for information only and does not form part of any contract with Laird. All specifications are subject to change without notice. Laird assumes no responsibility and disclaims all liability for losses or damages resulting from use of or reliance on this information. All Laird products are sold subject to the Laird Terms and Conditions of sale (including Laird's limited warranty) in effect from time to time, a copy of which will be furnished upon request.

© Copyright 2019-2021 Laird Thermal Systems, Inc. All rights reserved. Laird<sup>™</sup>, the Laird Ring Logo, and Laird Thermal Systems<sup>™</sup> are trademarks or registered trademarks of Laird Limited or its subsidiaries.

Date: 12/14/2021