



TAOGLAS®



Datasheet

Phoenix

Part No:
GSA.8827.A.101111

Description:

Phoenix Wideband Cellular 5G/4G I-Bar Antenna
For First-Tier Automotive Applications

Features:

5G/4G Adhesive Mount Antenna
Covering Sub 6GHz 5G NR Bands
Covering Worldwide 5G Bands
3G/2G Backward compatible
Low profile for easy installation
Cable: 1m RG-174
Connector: SMA(M)
Dimensions: 105mm*30*7.7mm
RoHS & REACH Compliant

1. Introduction	3
2. Specifications	4
3. Antenna Characteristics	6
4. Radiation Patterns	9
5. Mechanical Drawing	30
6. Packaging	31
7. Application Note	32
<hr/>	
Changelog	37

Taoglas makes no warranties based on the accuracy or completeness of the contents of this document and reserves the right to make changes to specifications and product descriptions at any time without notice. Taoglas reserves all rights to this document and the information contained herein. Reproduction, use or disclosure to third parties without express permission is strictly prohibited.



1. Introduction



The GSA.8827 Phoenix Ultra-Wideband I-Bar antenna is a robust high efficiency cellular antenna for use with all 5G/4G cellular modules worldwide.

Its slim-line design allows for covert and convenient installation in automotive vehicles, its omnidirectional gain across all bands ensures constant reception and transmission. GSA.8827 is manufactured and tested in a TS16949 first tier automotive approved facility, and it has gone through full PPAP design, reliability and quality audits.

Typical Applications:

- Telematics
- Transportation
- Gateways and Routers

With its unique ultra-wide band dipole design, the Phoenix has exceptional industry performance characteristics considering its very low profile at 7.7mm and has a compact size of only 105mm*30mm.

This antenna is designed to be mounted on glass or plastic (not on metal). It comes with strong 3M double-sided adhesive for a permanent and secure fix to your vehicle interior. The antenna is UV Resistant.

Customized cable length and connectors are available, contact your regional Taoglas Customer Support Team for more information.

2. Specifications

5G/4G Electrical									
Band	Frequency (MHz)	Ground Plane	Efficiency (%)	Average Gain (dB)	Peak Gain (dBi)	Impedance	Max Power Input	Polarization	Radiation Pattern
5G/4G Band 71	617~698	Free space	20.8	-6.8	-1.1	50Ω	10W	Linear	Omni
		On Glass	28.3	-5.5	0.5				
4G/3G Band 12,13,14,17,28,29	698~806	Free space	37.2	-4.3	1.8				
		On Glass	47.7	-3.2	1.8				
4G/3G Band 5,8,18,19,20,26,27	824~960	Free space	53.2	-2.7	2.8				
		On Glass	48.7	-3.1	2.7				
5G/4G Band 21,32,74,75,76	1427~1518	Free space	44.8	-2.4	1.6				
		On Glass	53	-2	2.4				
4G/3G Band 1,2,3,4,9,23,25,35,39,66	1710~2200	Free space	58	-2.3	3				
		On Glass	57.5	-3.4	5.9				
4G/3G Band 7,30,38,40,41	2300~2690	Free space	37.5	-4.3	4.7				
		On Glass	32.4	-4.9	7.3				
5G NR Band 22,42,48,77,78,79	3300~4200	Free space	24.6	-4.8	2.3				
		On Glass	30.2	-5.2	2.4				

Mechanical	
Dimensions	105*30*7.7mm
Weight	50g
Material	UV Resistant PC/ABS
Connector	SMA Male (customizable)
Cable	RG-174
Environmental	
Cable Pull	8kgf
Temperature Range	-40°C to 85°C
Humidity	Non-condensing 65°C 95% RH
Shock (Drop Test)	1m drop on concrete 6 axes

5G/4G Bands			
Band Number	5GNR / FR1 / LTE / LTE-Advanced / WCDMA / HSPA / HSPA+ / TD-SCDMA		
	Uplink	Downlink	Covered
1	UL: 1920 to 1980	DL: 2110 to 2170	✓
2	UL: 1850 to 1910	DL: 1930 to 1990	✓
3	UL: 1710 to 1785	DL: 1805 to 1880	✓
4	UL: 1710 to 1755	DL: 2110 to 2155	✓
5	UL: 824 to 849	DL: 869 to 894	✓
7	UL: 2500 to 2570	DL: 2620 to 2690	✓
8	UL: 880 to 915	DL: 925 to 960	✓
9	UL: 1749.9 to 1784.9	DL: 1844.9 to 1879.9	✓
11	UL: 1427.9 to 1447.9	DL: 1475.9 to 1495.9	✓
12	UL: 699 to 716	DL: 729 to 746	✓
13	UL: 777 to 787	DL: 746 to 756	✓
14	UL: 788 to 798	DL: 758 to 768	✓
17	UL: 704 to 716	DL: 734 to 746	✓
18	UL: 815 to 830	DL: 860 to 875	✓
19	UL: 830 to 845	DL: 875 to 890	✓
20	UL: 832 to 862	DL: 791 to 821	✓
21	UL: 1447.9 to 1462.9	DL: 1495.9 to 1510.9	✓
22	UL: 3410 to 3490	DL: 3510 to 3590	✓
23	UL: 2000 to 2020	DL: 2180 to 2200	✓
24	UL: 1625.5 to 1660.5	DL: 1525 to 1559	✓
25	UL: 1850 to 1915	DL: 1930 to 1995	✓
26	UL: 814 to 849	DL: 859 to 894	✓
27	UL: 807 to 824	DL: 852 to 869	✓
28	UL: 703 to 748	DL: 758 to 803	✓
29	UL: -	DL: 717 to 728	✓
30	UL: 2305 to 2315	DL: 2350 to 2360	✓
31	UL: 452.5 to 457.5	DL: 462.5 to 467.5	✗
32	UL: -	DL: 1452 to 1496	✓
35		1850 to 1910	✓
38		2570 to 2620	✓
39		1880 to 1920	✓
40		2300 to 2400	✓
41		2496 to 2690	✓
42		3400 to 3600	✓
43		3600 to 3800	✓
48		3550 to 3700	✓
66	UL: 1710-1780	DL: 2110-2200	✓
71		617 to 698	✓
74/75/76		1427 to 1518	✓
77		3300 to 4200	✓
78		3300 to 3800	✓
79		4400 to 5000	✓

3. Antenna Characteristics

3.1 Return Loss

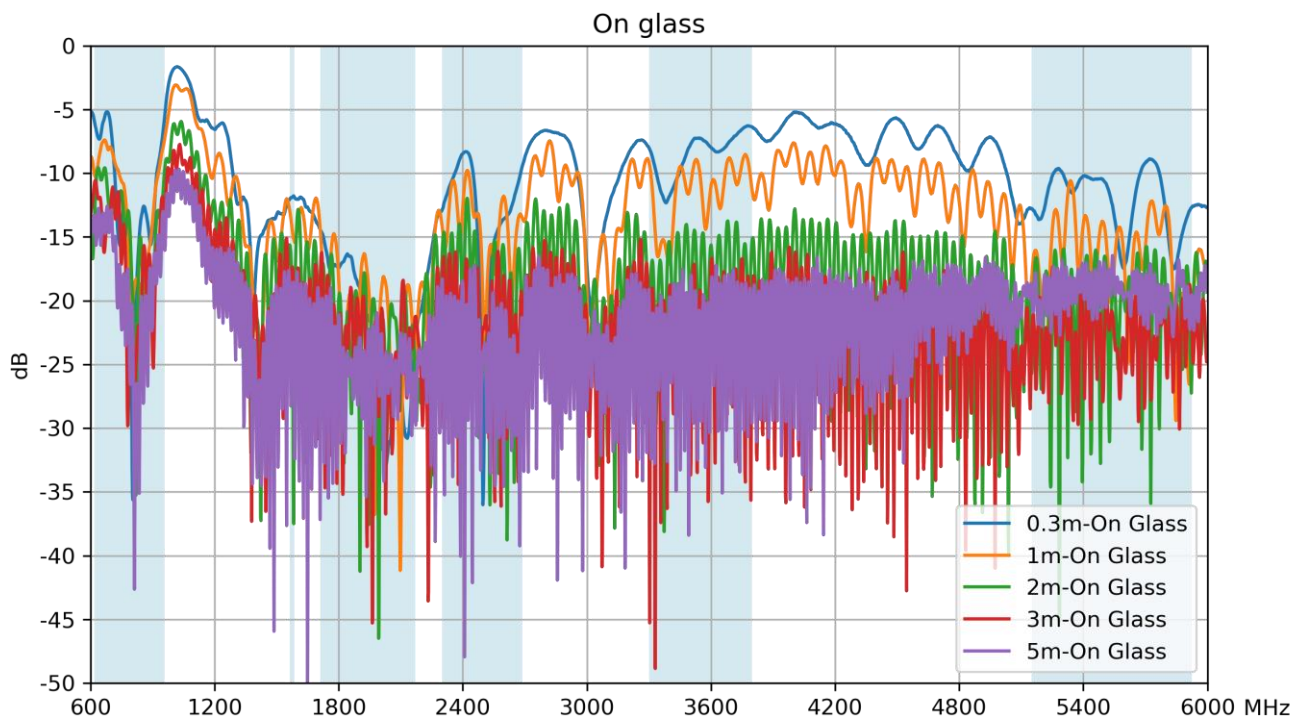
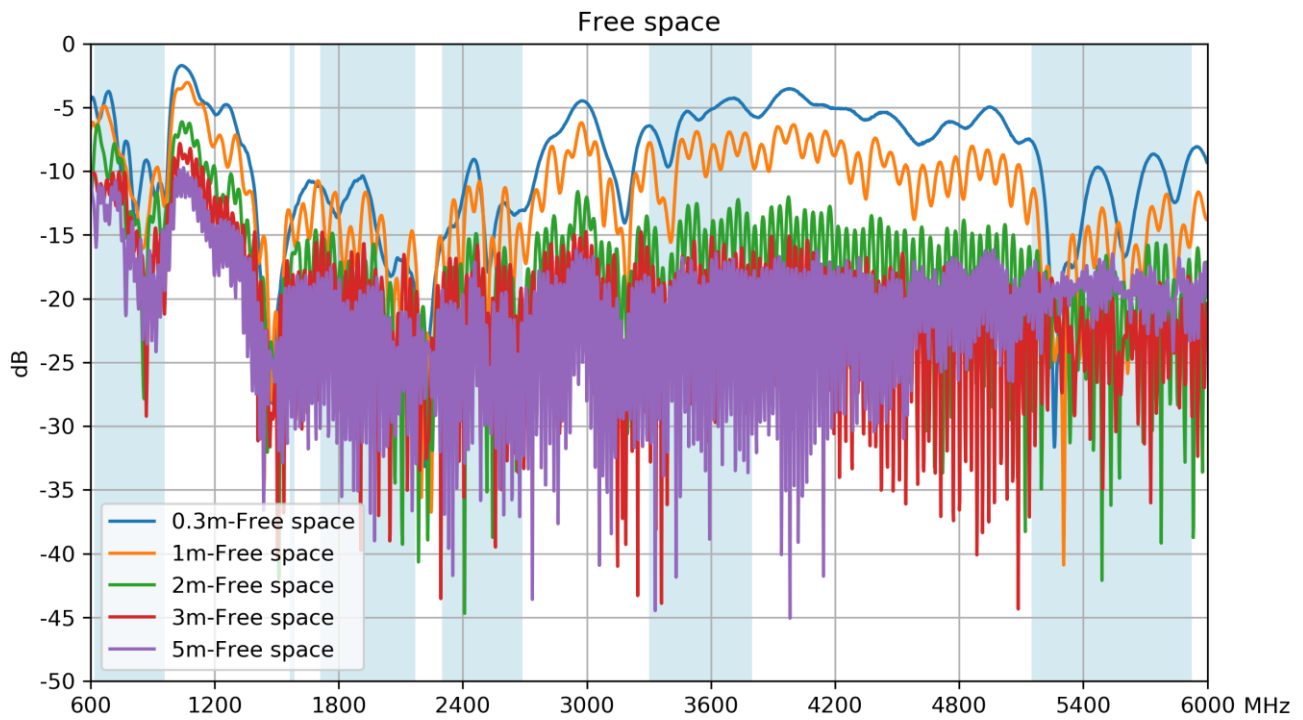

3.2 Efficiency

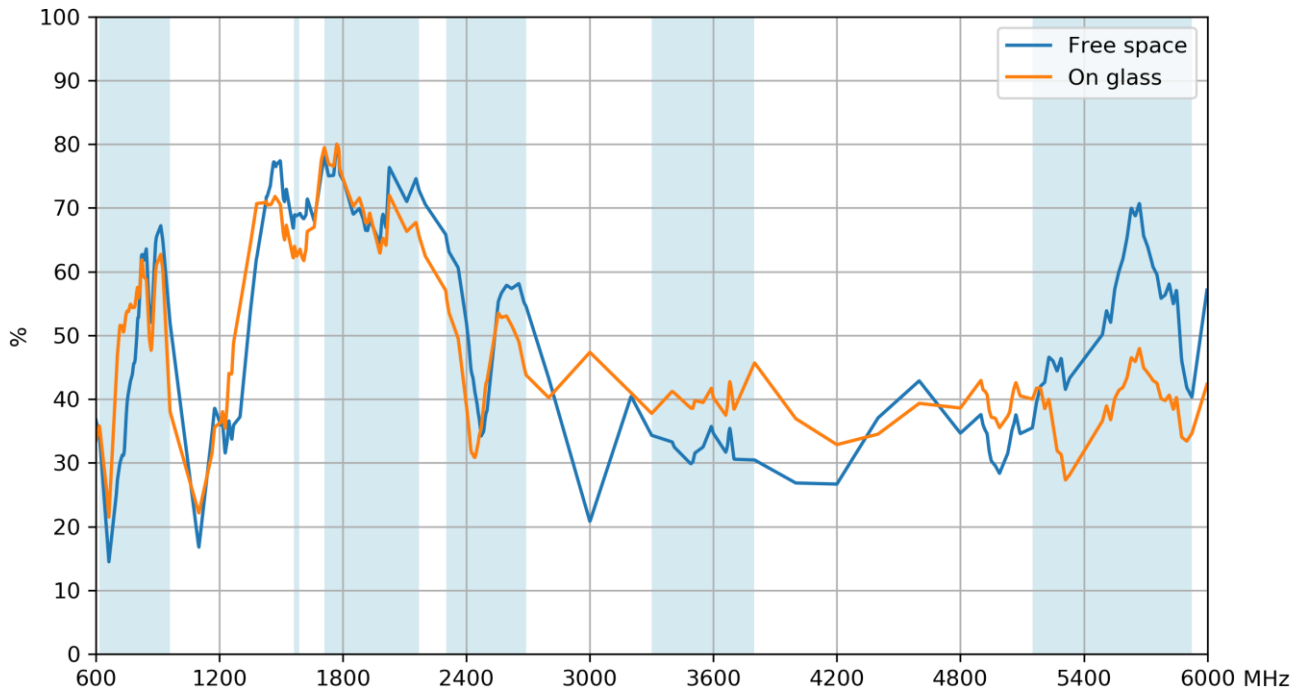

3.3 Average Gain

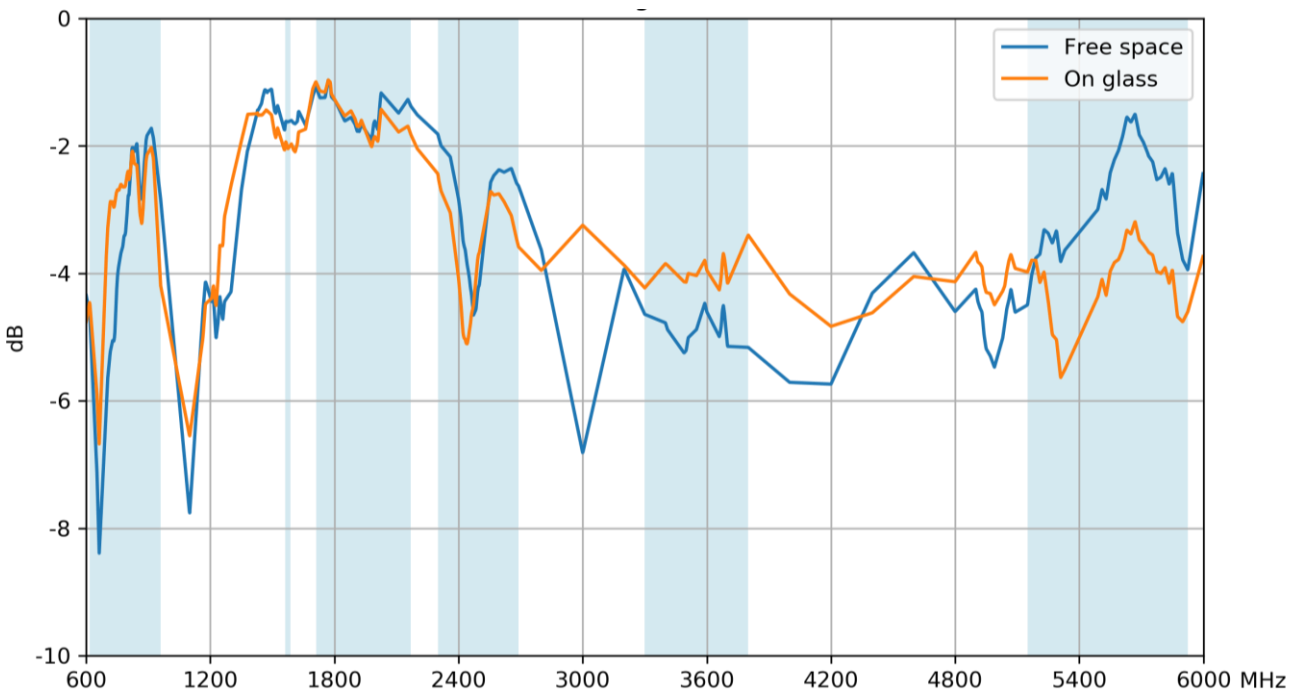

3.4 Peak Gain

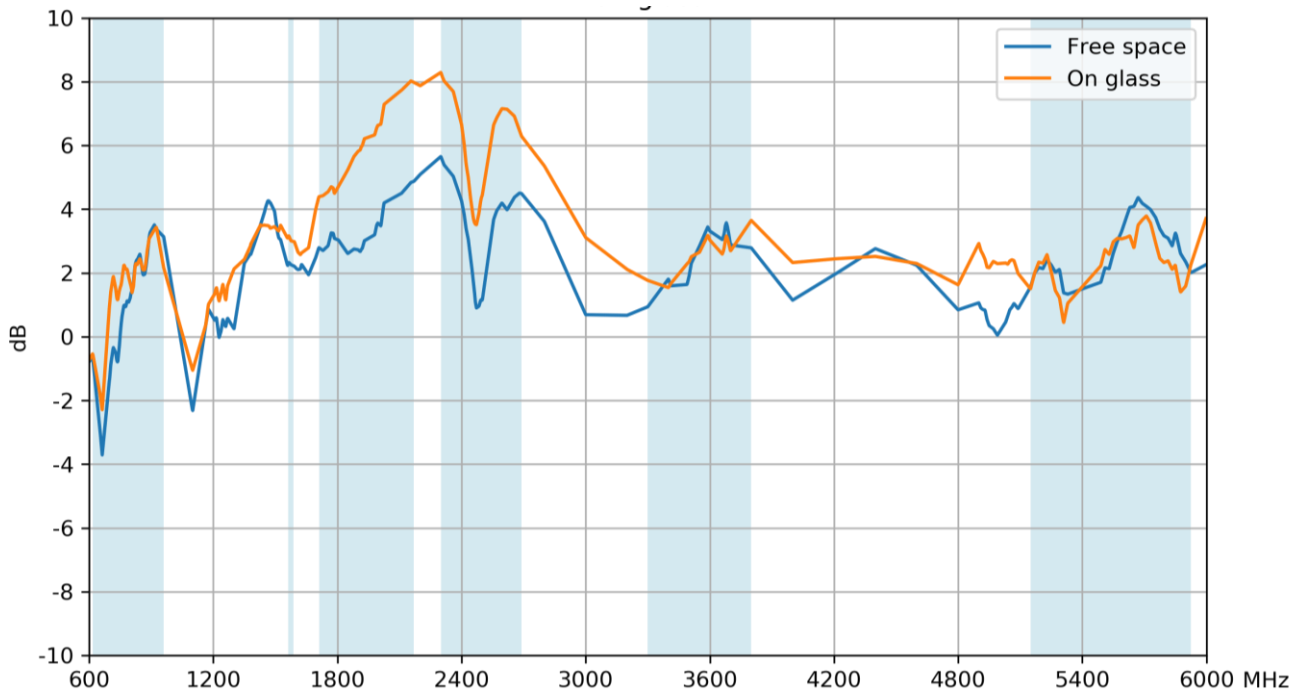

4. Radiation Patterns

4.1 Test Setup

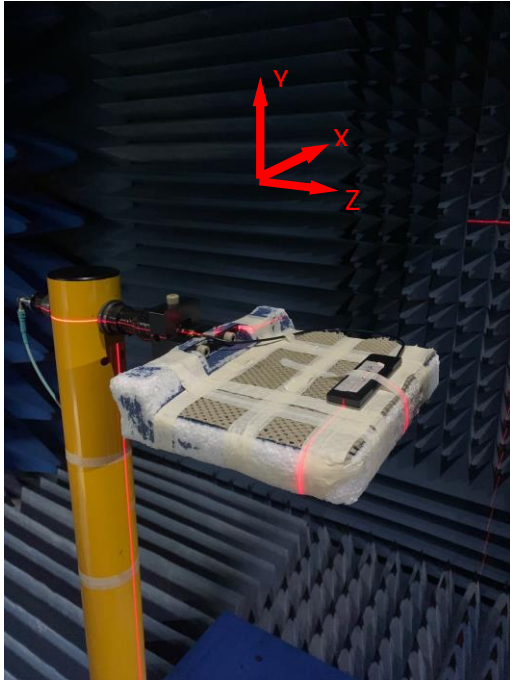

Free Space



On Glass

4.2 Free Space 3D and 2D Radiation Patterns

652MHz

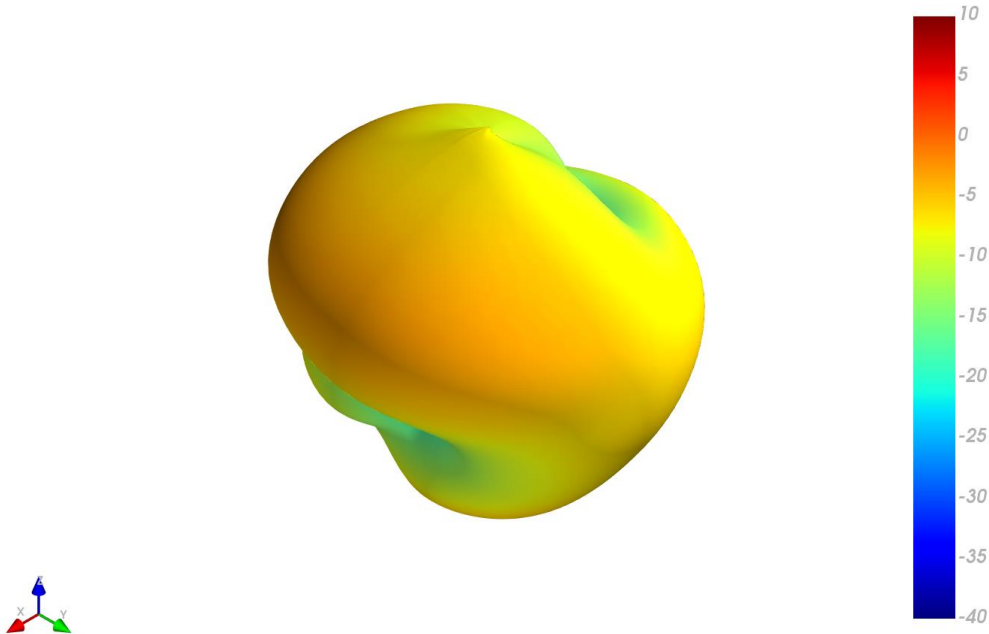

XY Plane

XZ Plane

YZ Plane

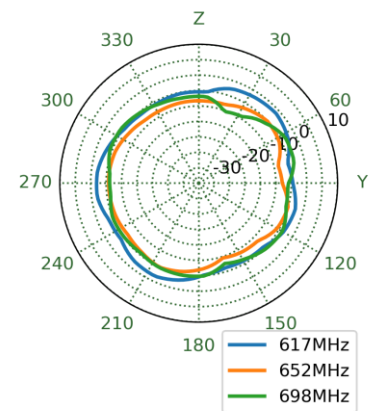
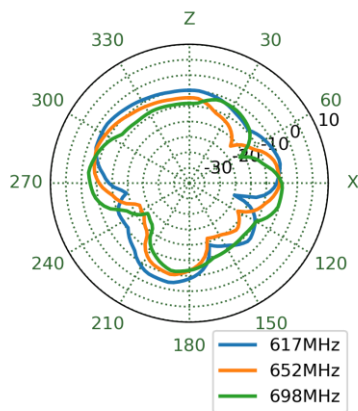
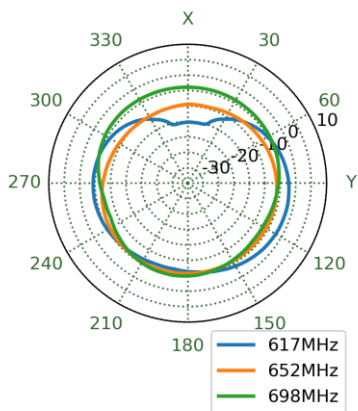

751MHz

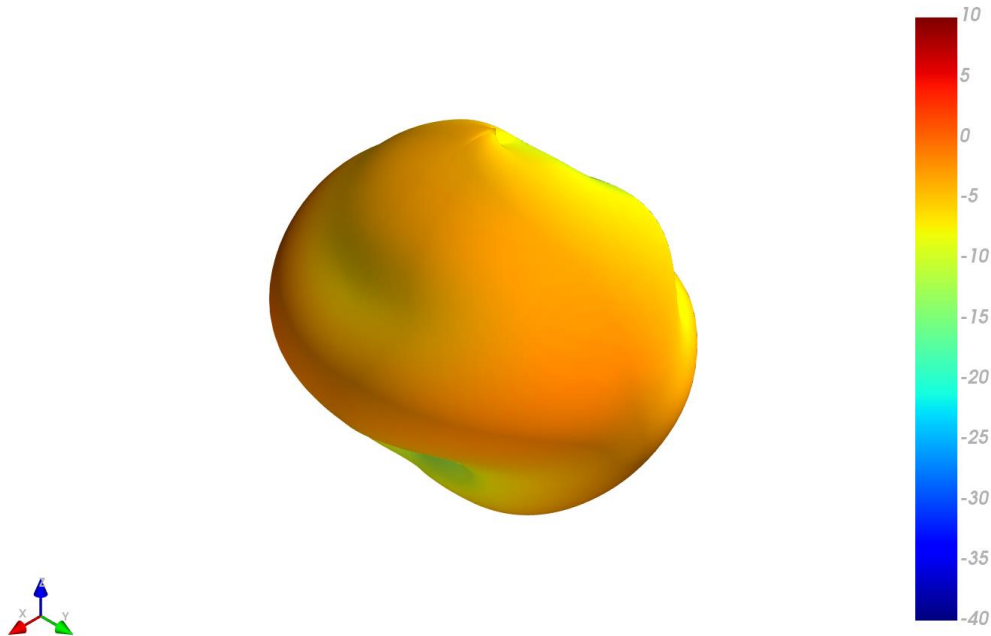

XY Plane

XZ Plane

YZ Plane

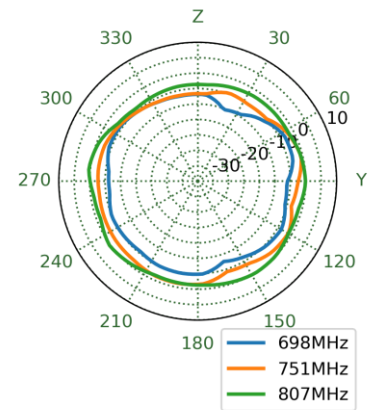
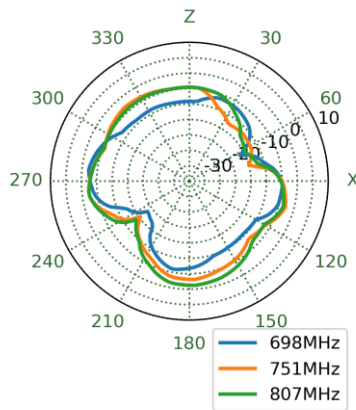
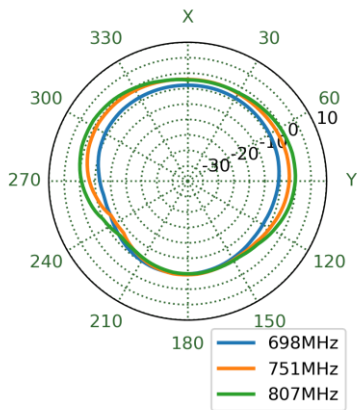

890MHz

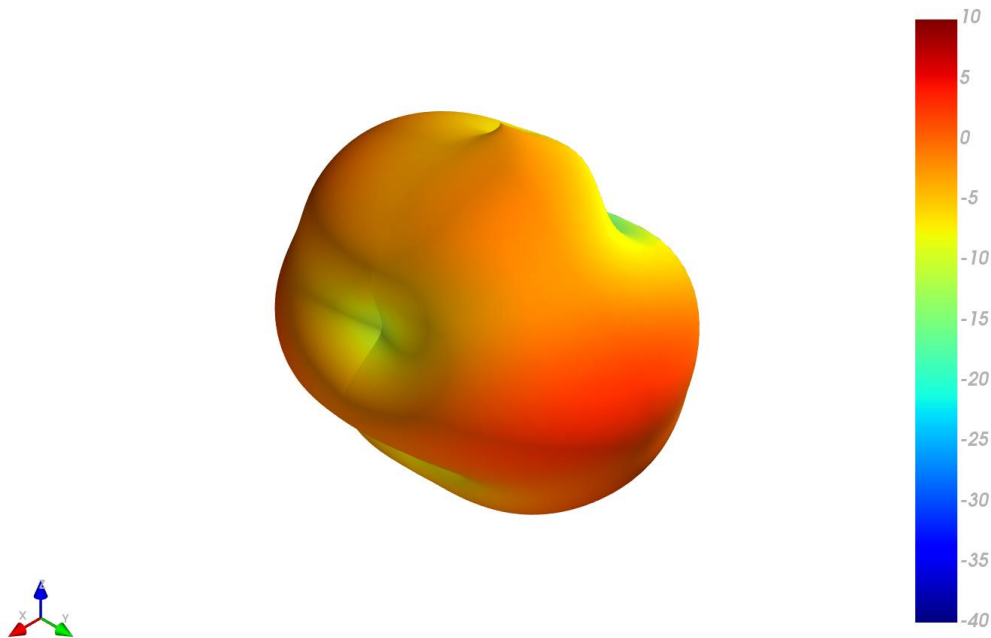

XY Plane

XZ Plane

YZ Plane

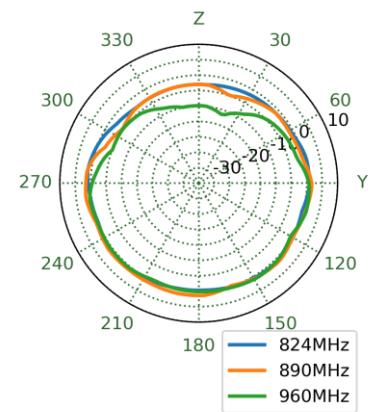
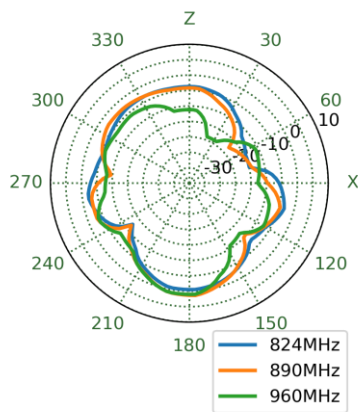
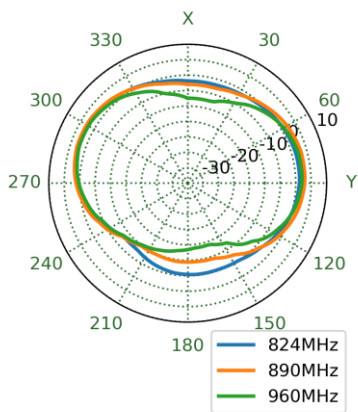

1470MHz

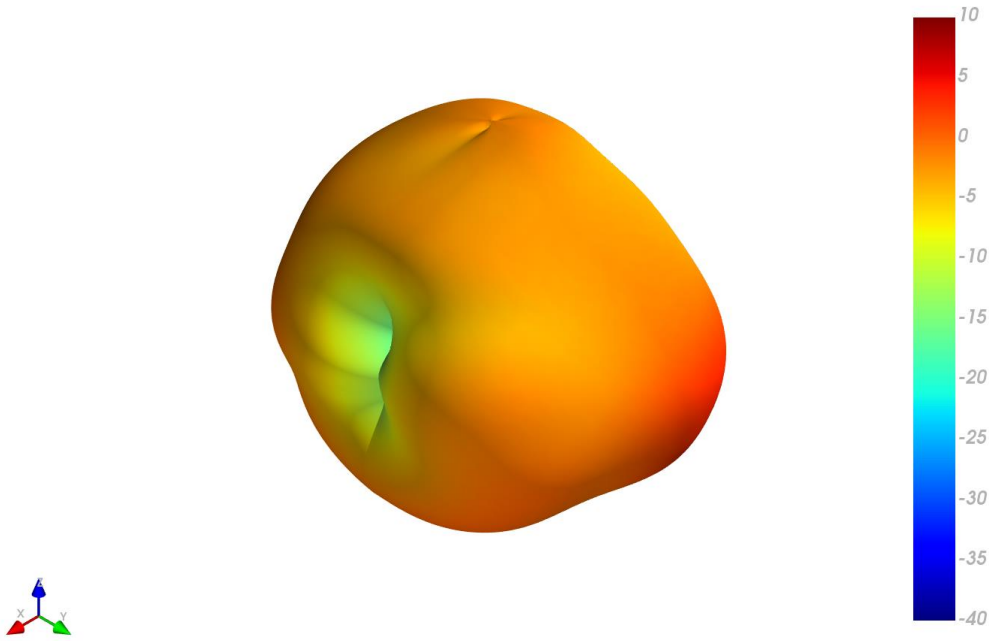

XY Plane XZ Plane YZ Plane

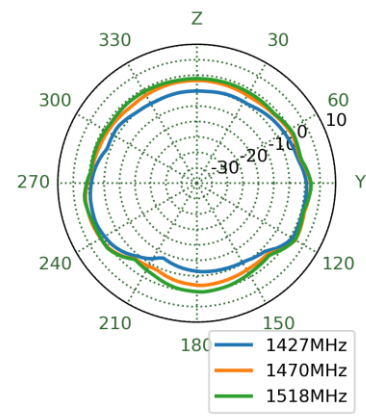
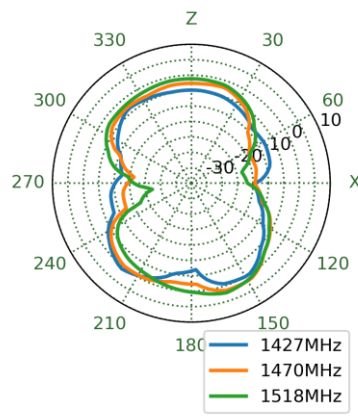
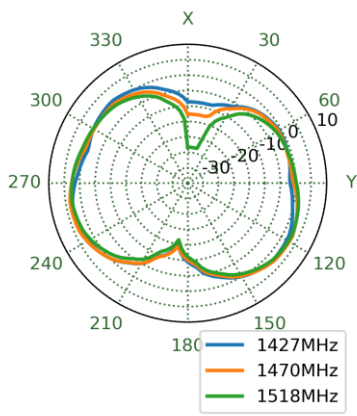

1805MHz

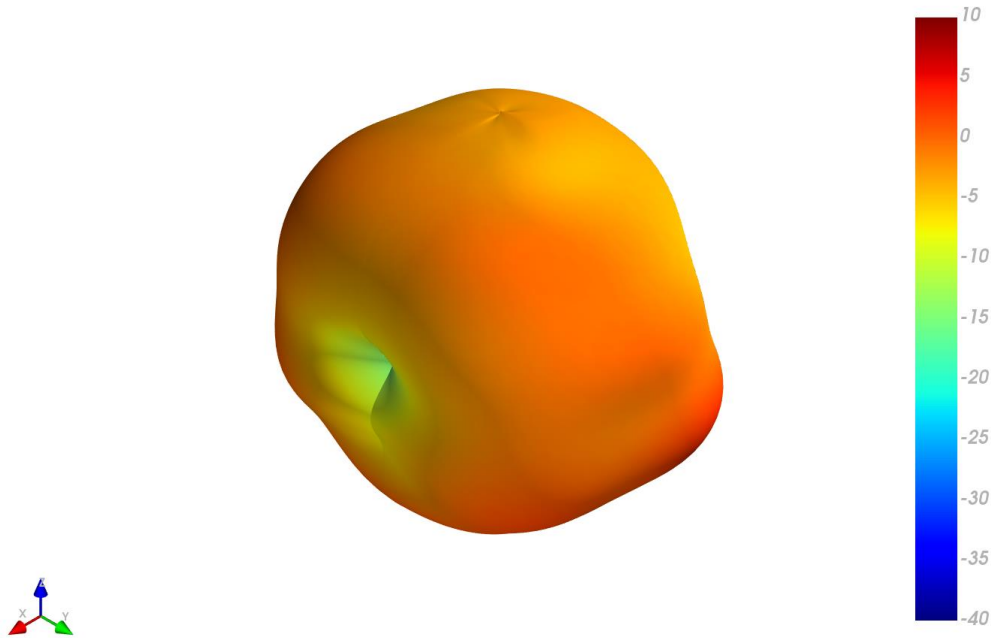

XY Plane XZ Plane YZ Plane

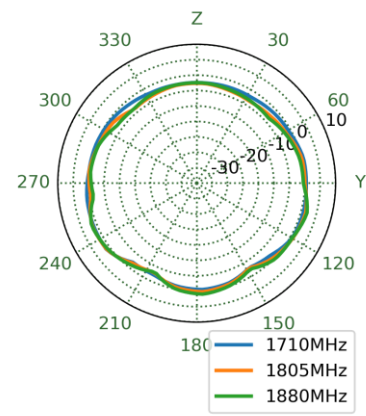
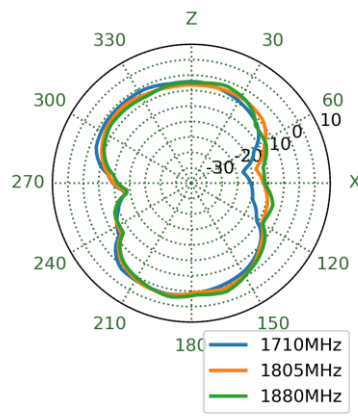
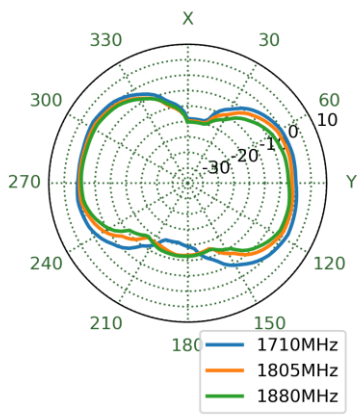

1920MHz

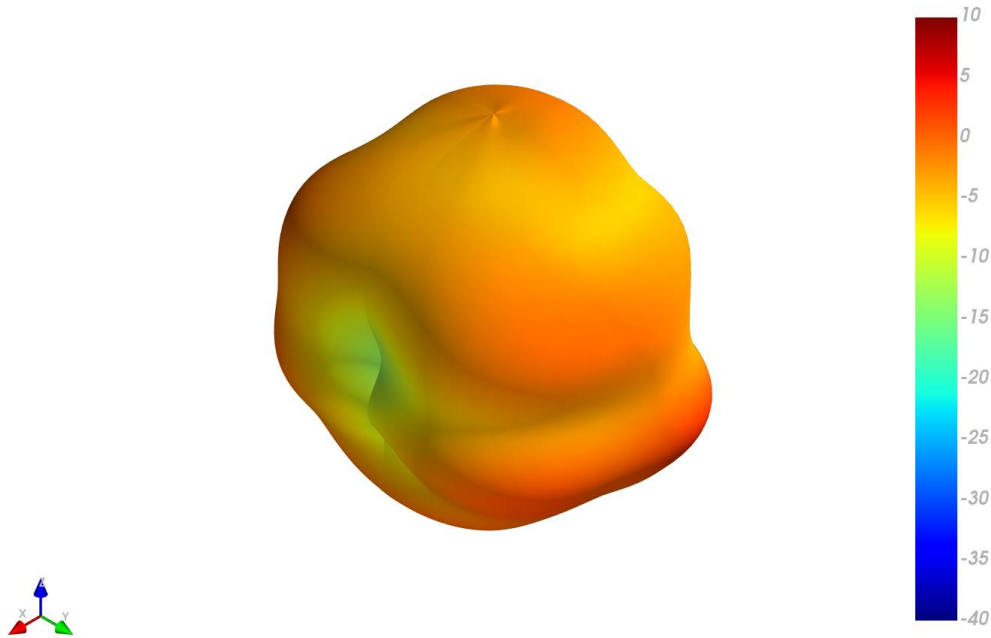

XY Plane XZ Plane YZ Plane

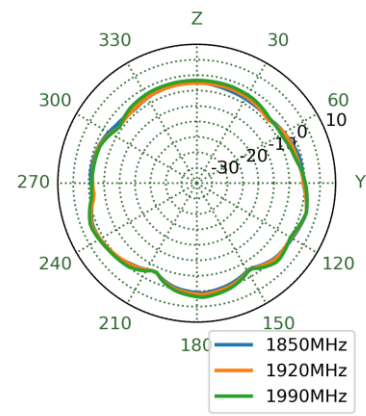
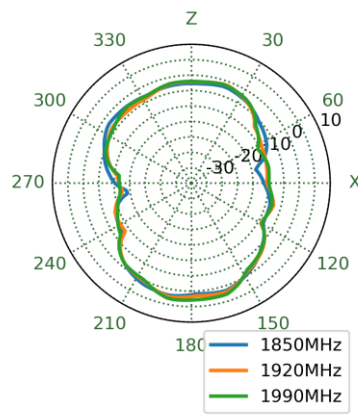
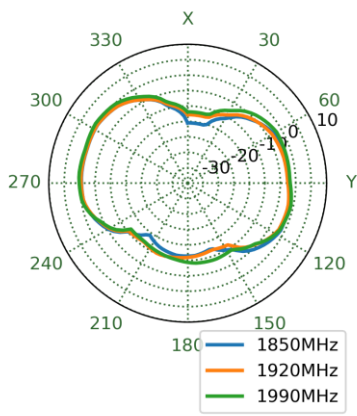

1990MHz

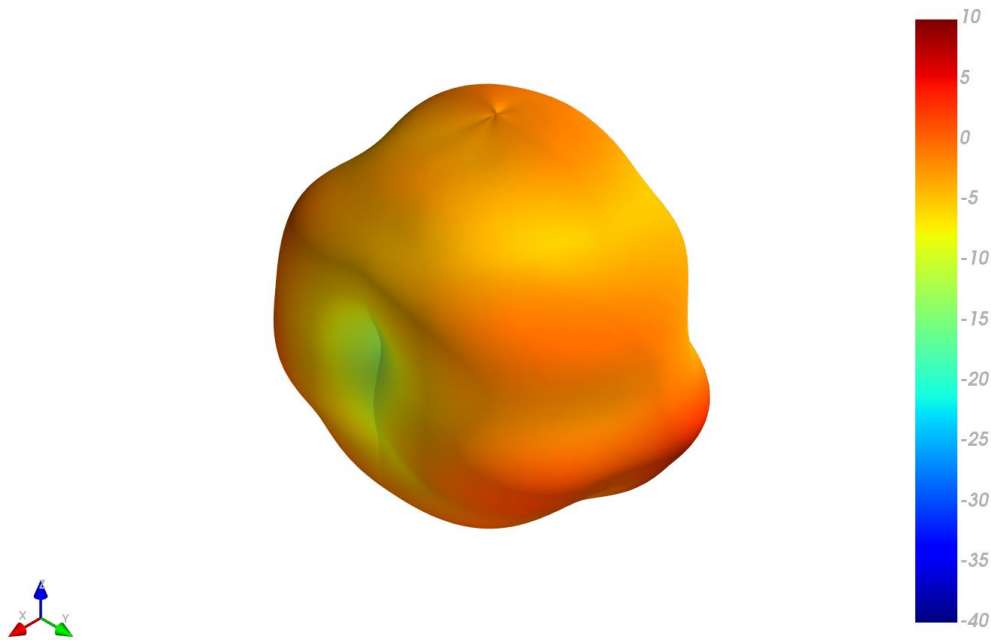

XY Plane XZ Plane YZ Plane

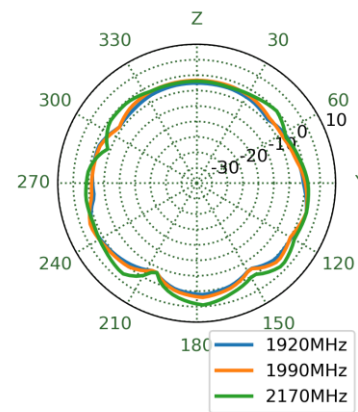
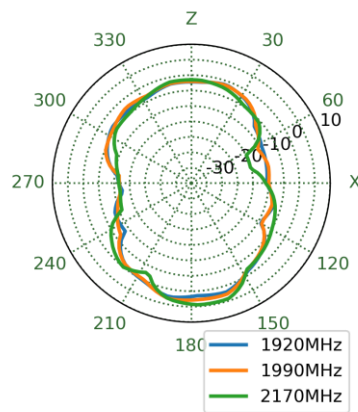
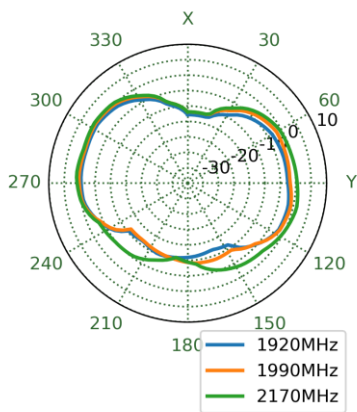

2595MHz

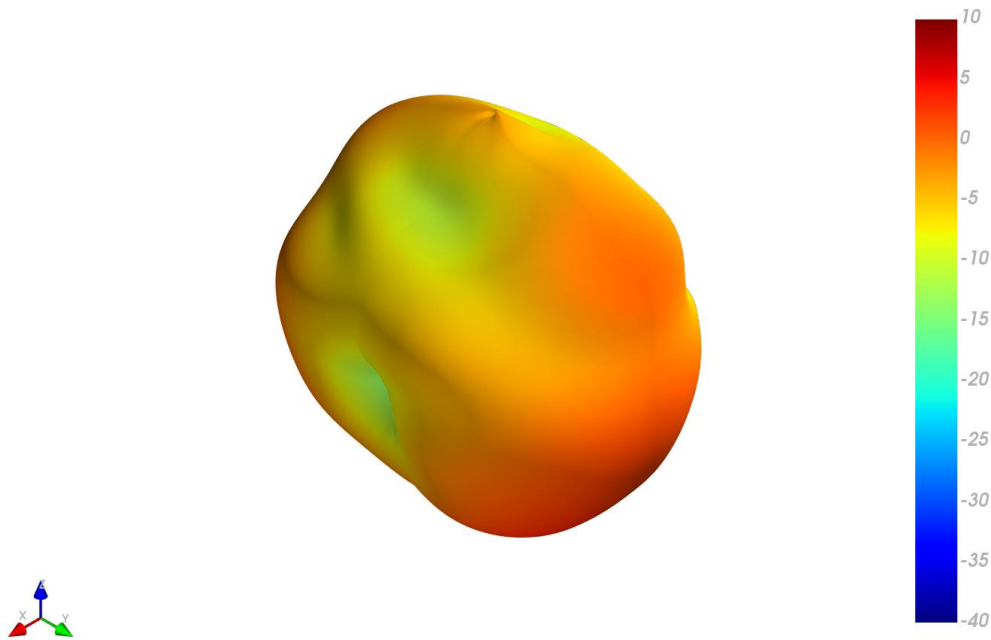

XY Plane XZ Plane YZ Plane

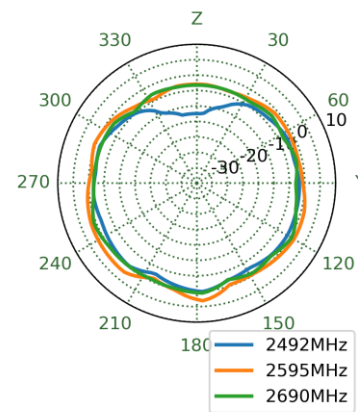
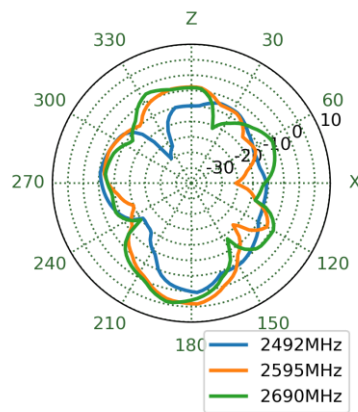
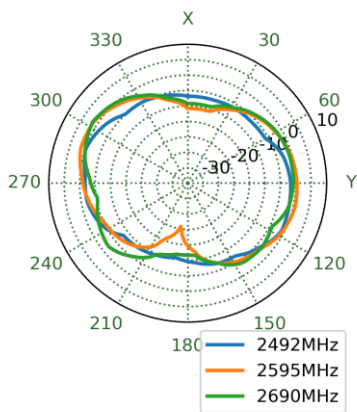

3550MHz

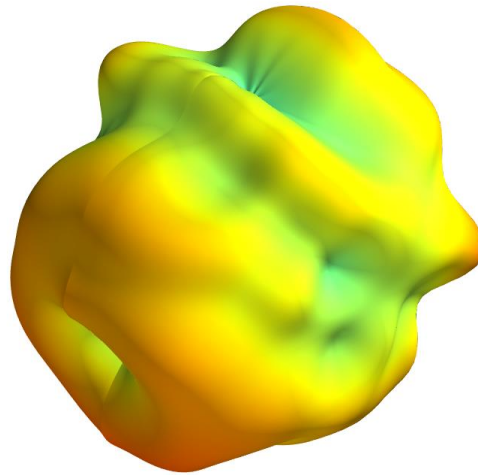

XY Plane XZ Plane YZ Plane

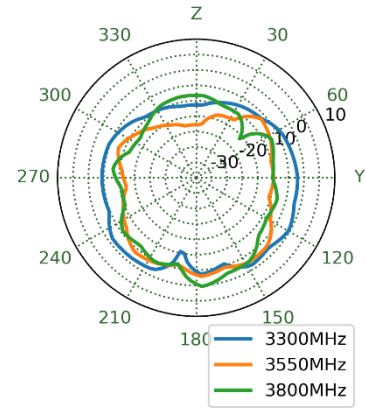
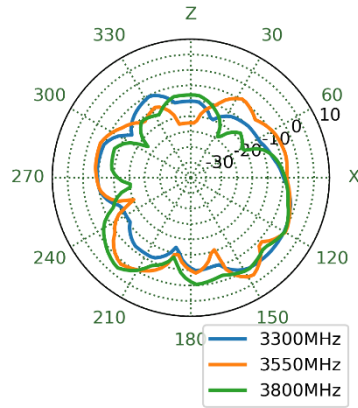
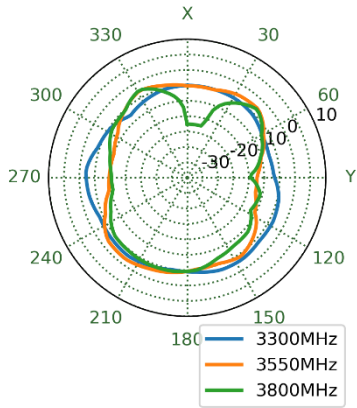

5330MHz

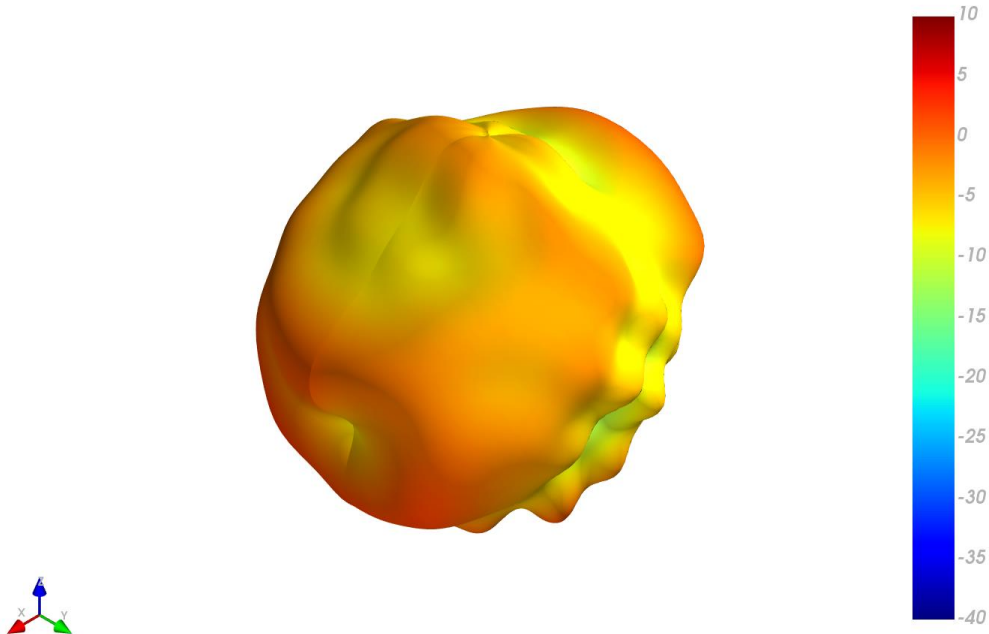

XY Plane XZ Plane YZ Plane

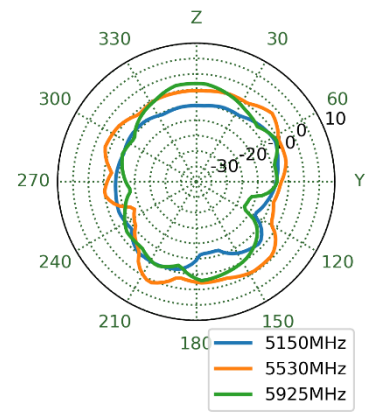
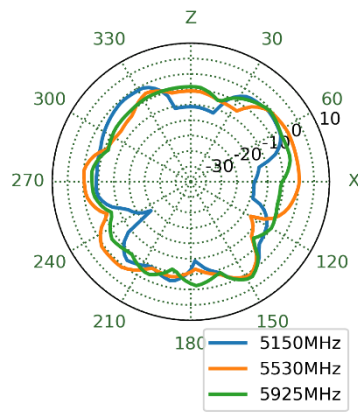
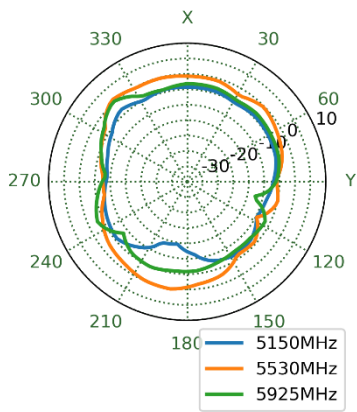

4.3 On Glass 3D and 2D Radiation Patterns

652MHz

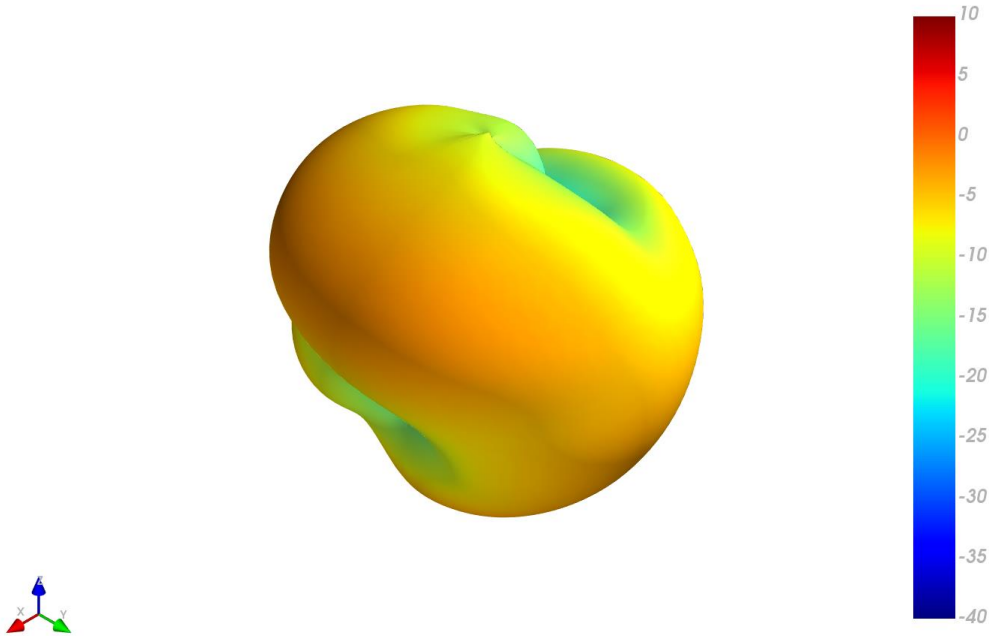

XY Plane XZ Plane YZ Plane

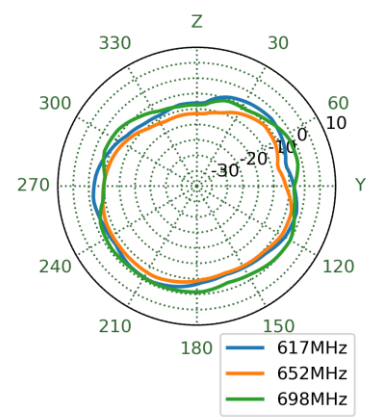
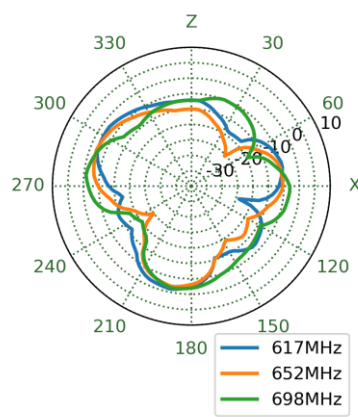
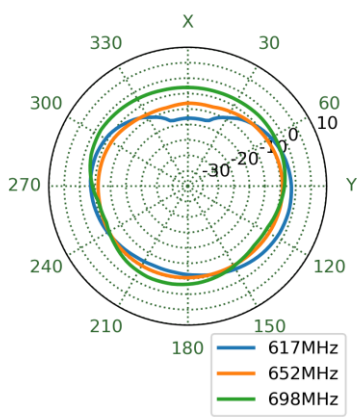

751MHz

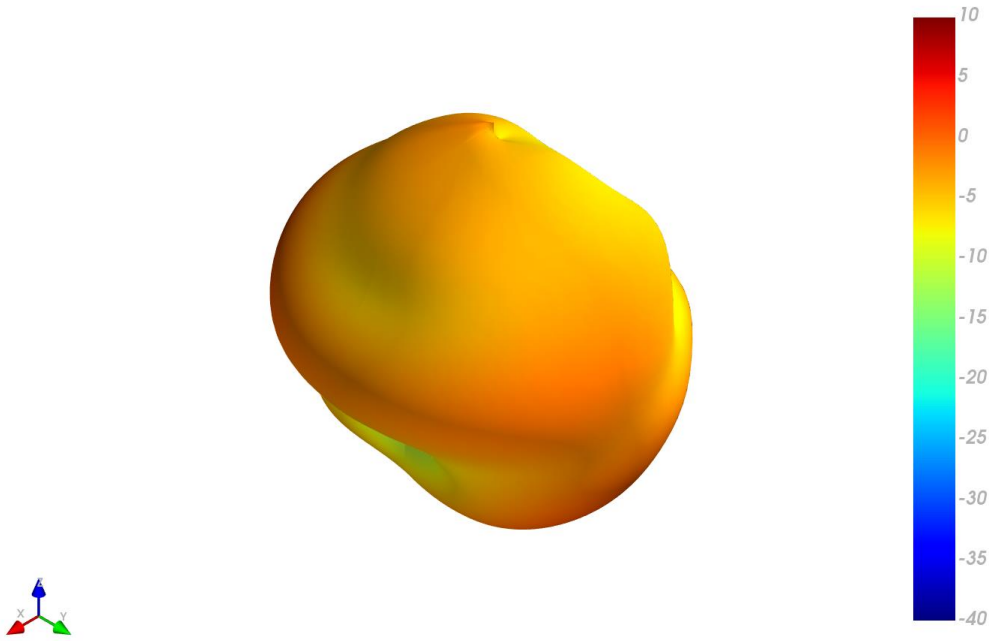

XY Plane XZ Plane YZ Plane

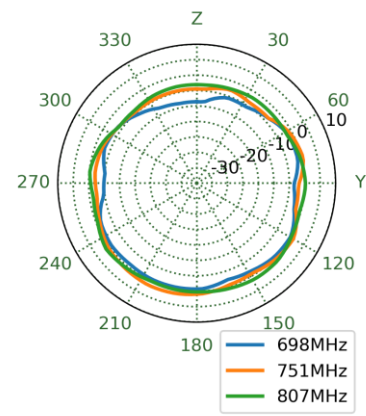
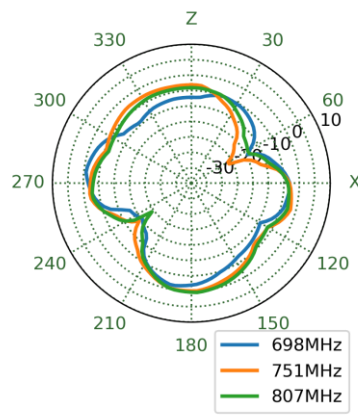
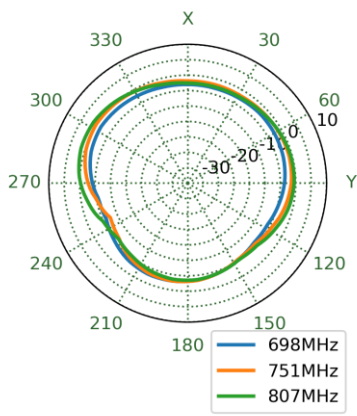

890MHz

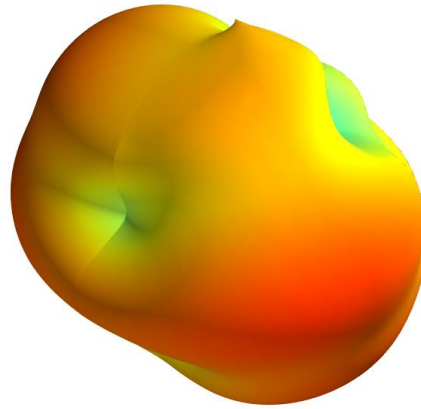

XY Plane XZ Plane YZ Plane

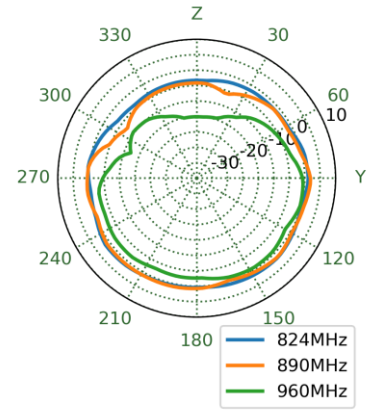
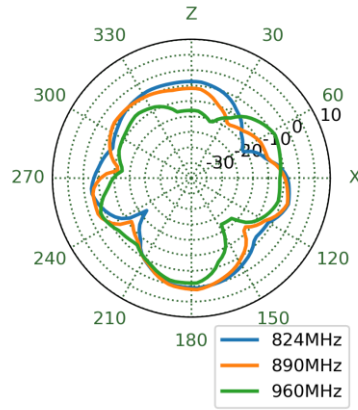
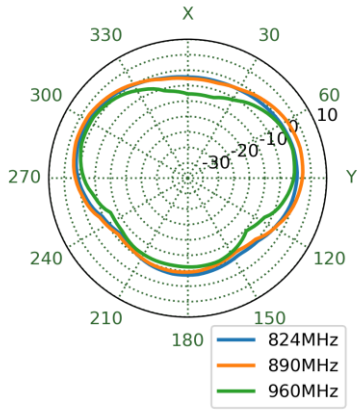

1470MHz

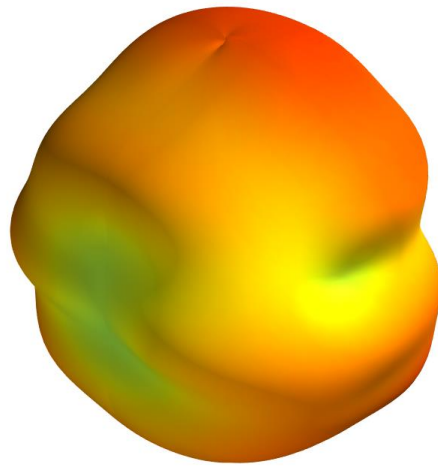

XY Plane XZ Plane YZ Plane

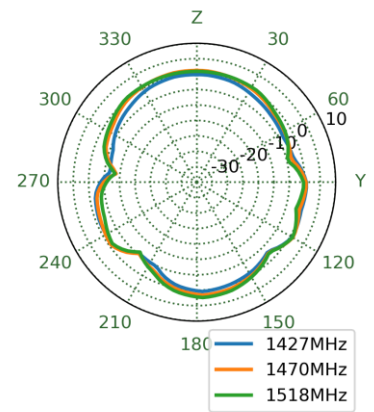
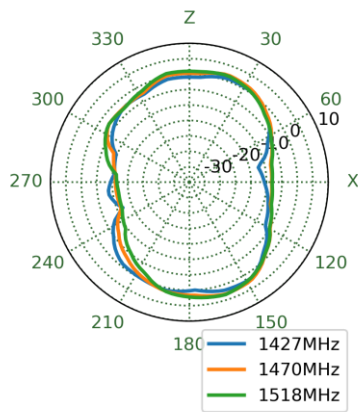
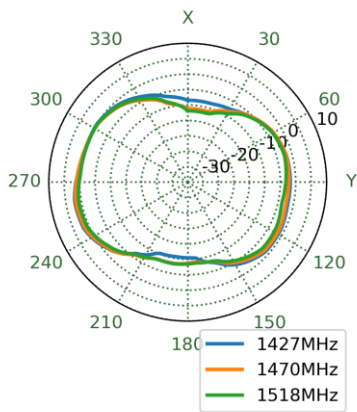

1805MHz

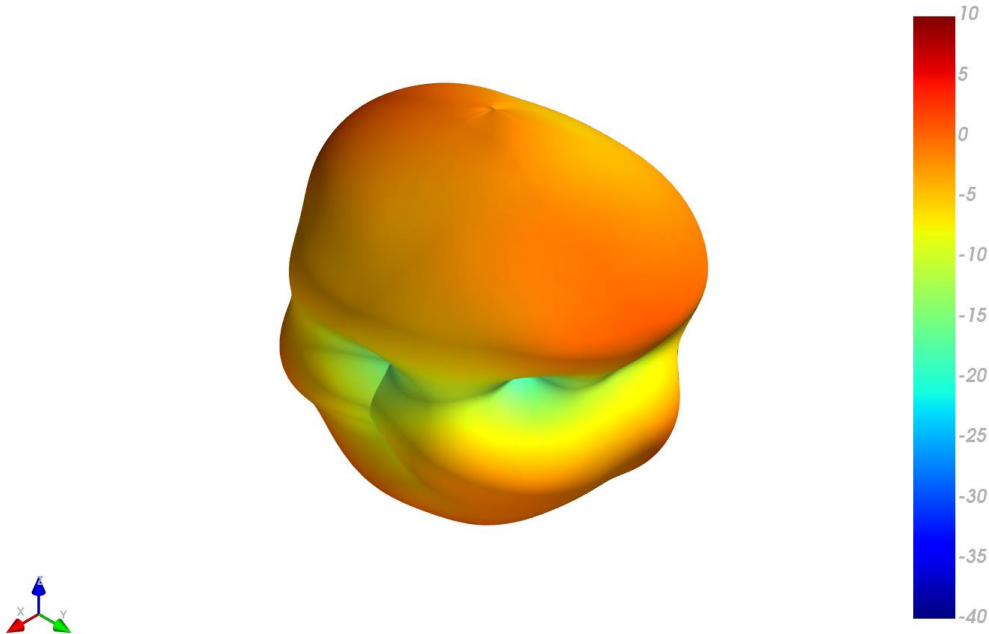

XY Plane XZ Plane YZ Plane

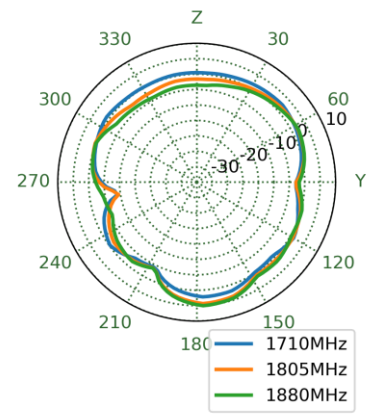
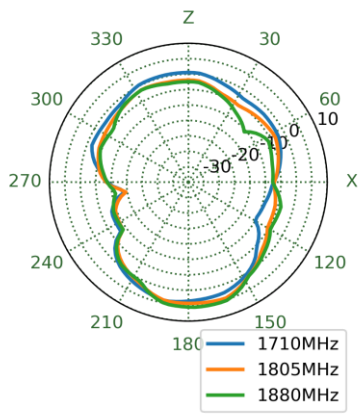
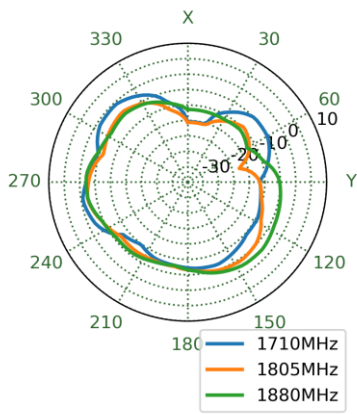

1920MHz

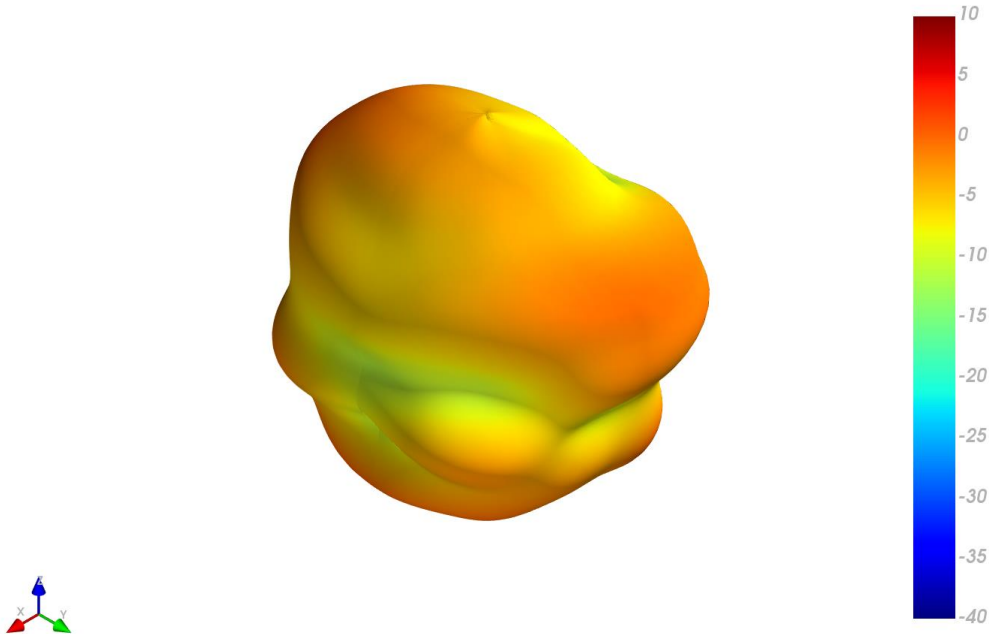

XY Plane XZ Plane YZ Plane

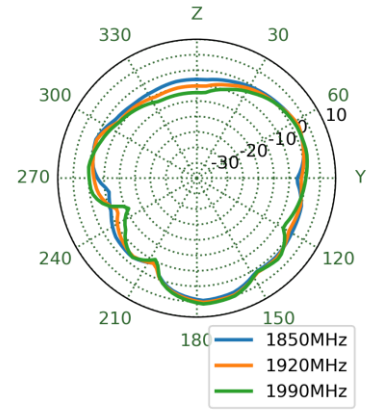
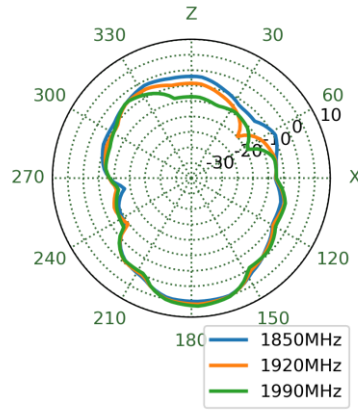
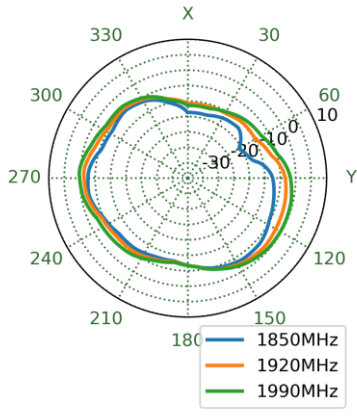

1990MHz

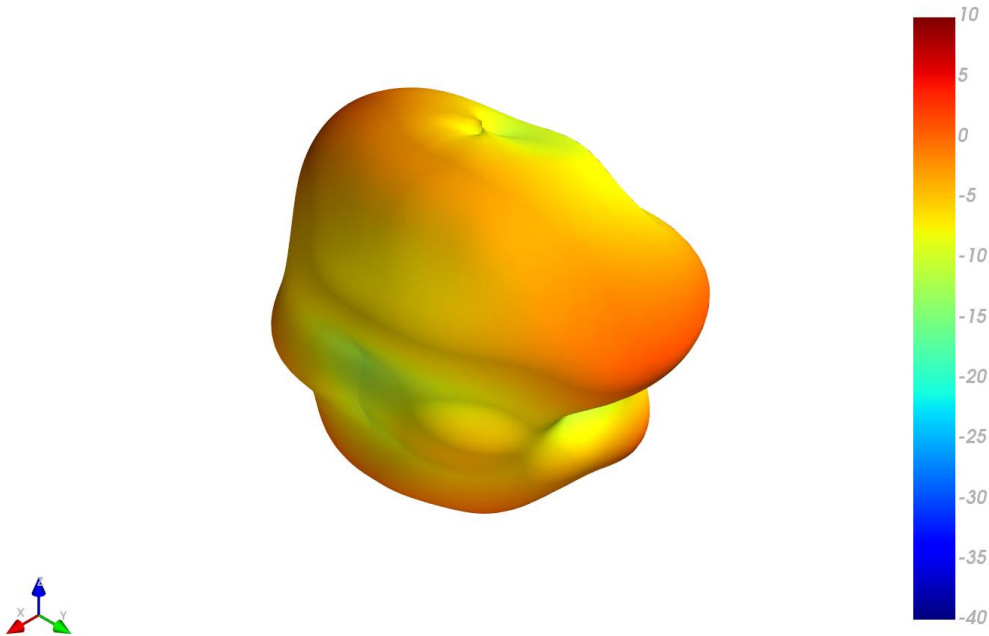

XY Plane XZ Plane YZ Plane

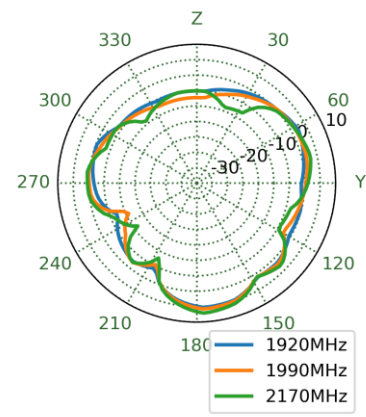
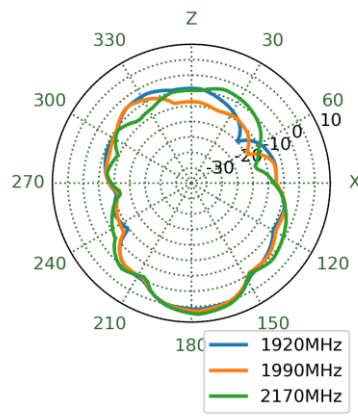
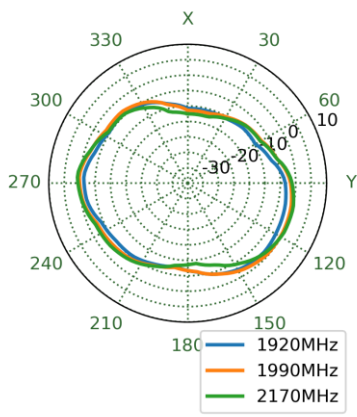

2595MHz

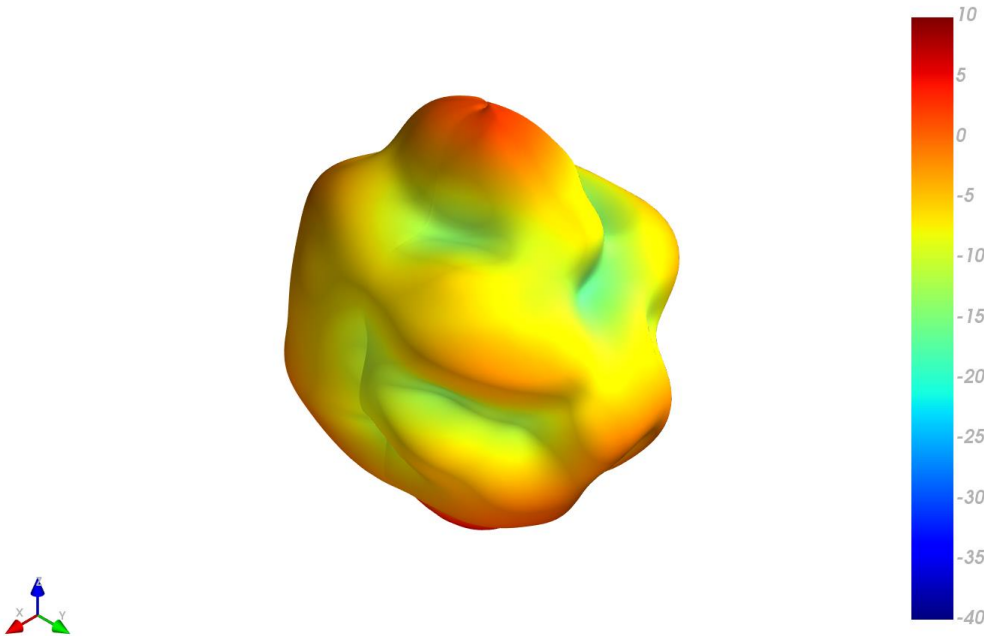

XY Plane XZ Plane YZ Plane

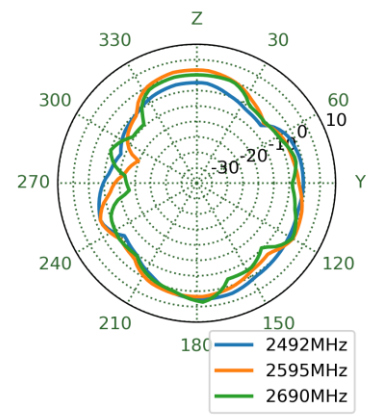
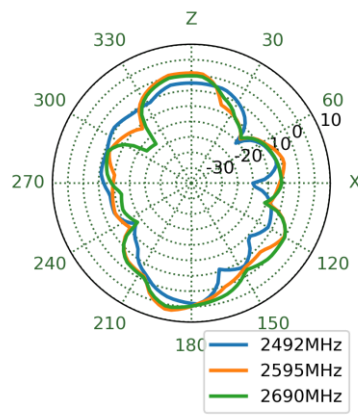
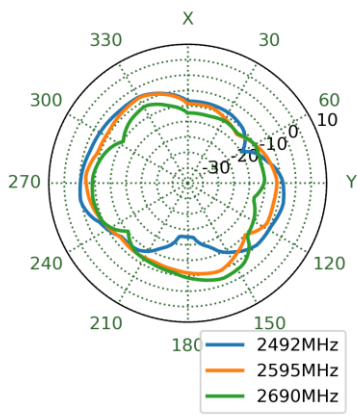

3550MHz

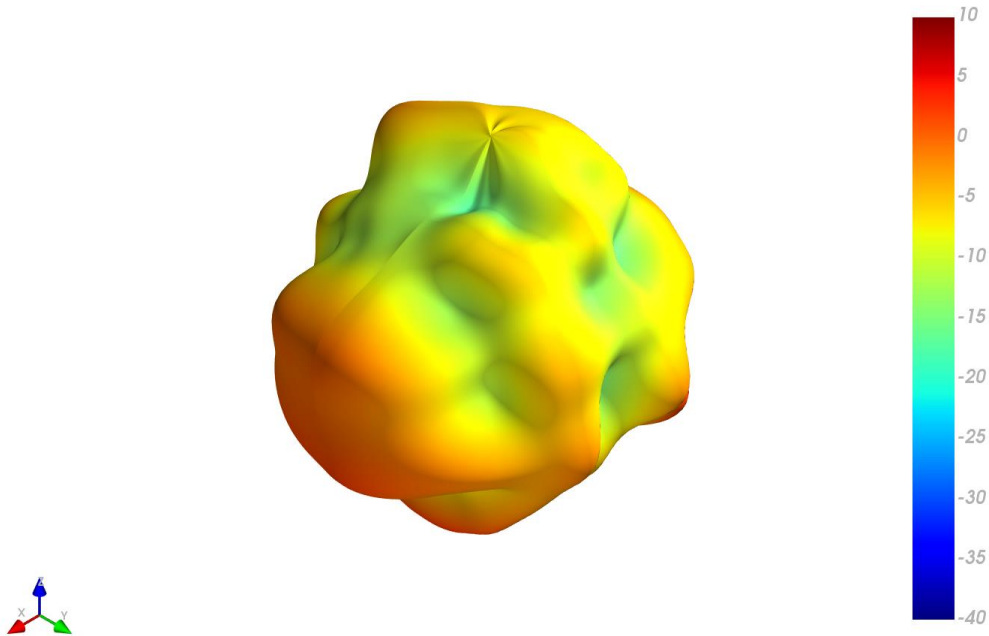

XY Plane XZ Plane YZ Plane

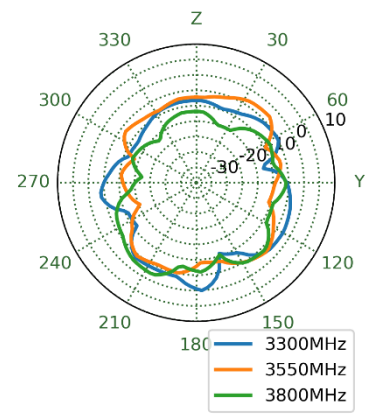
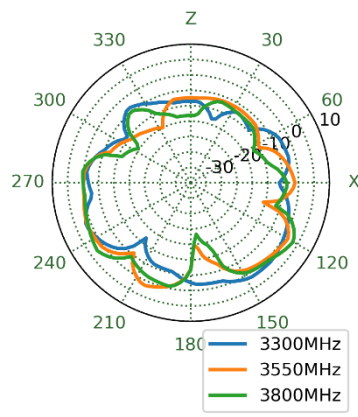
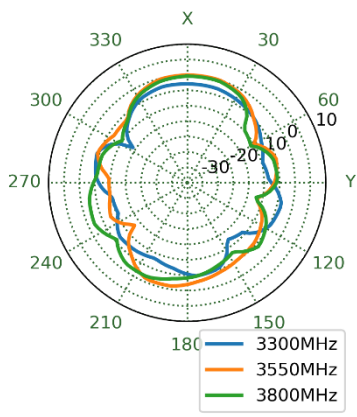

5530MHz

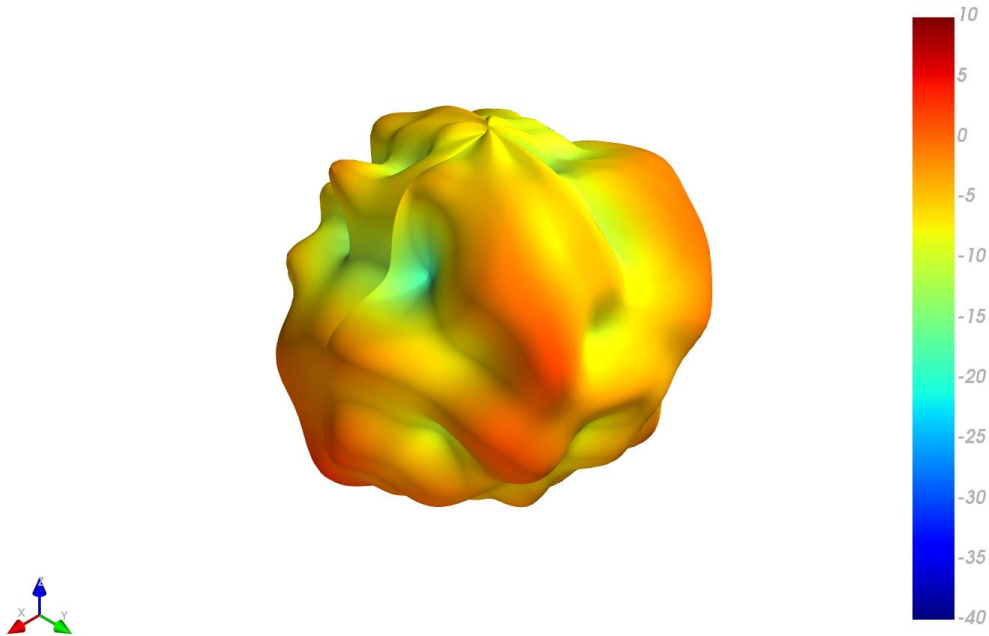

XY Plane XZ Plane YZ Plane

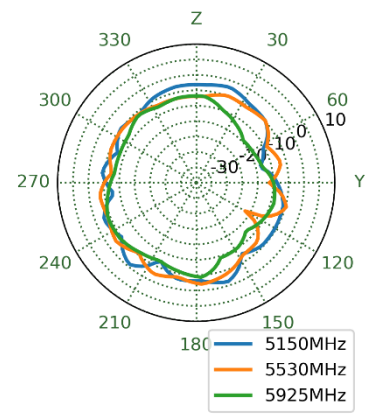
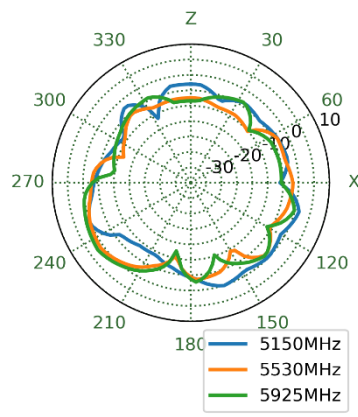
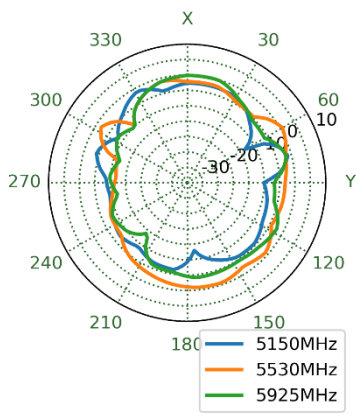

5. Mechanical Drawing

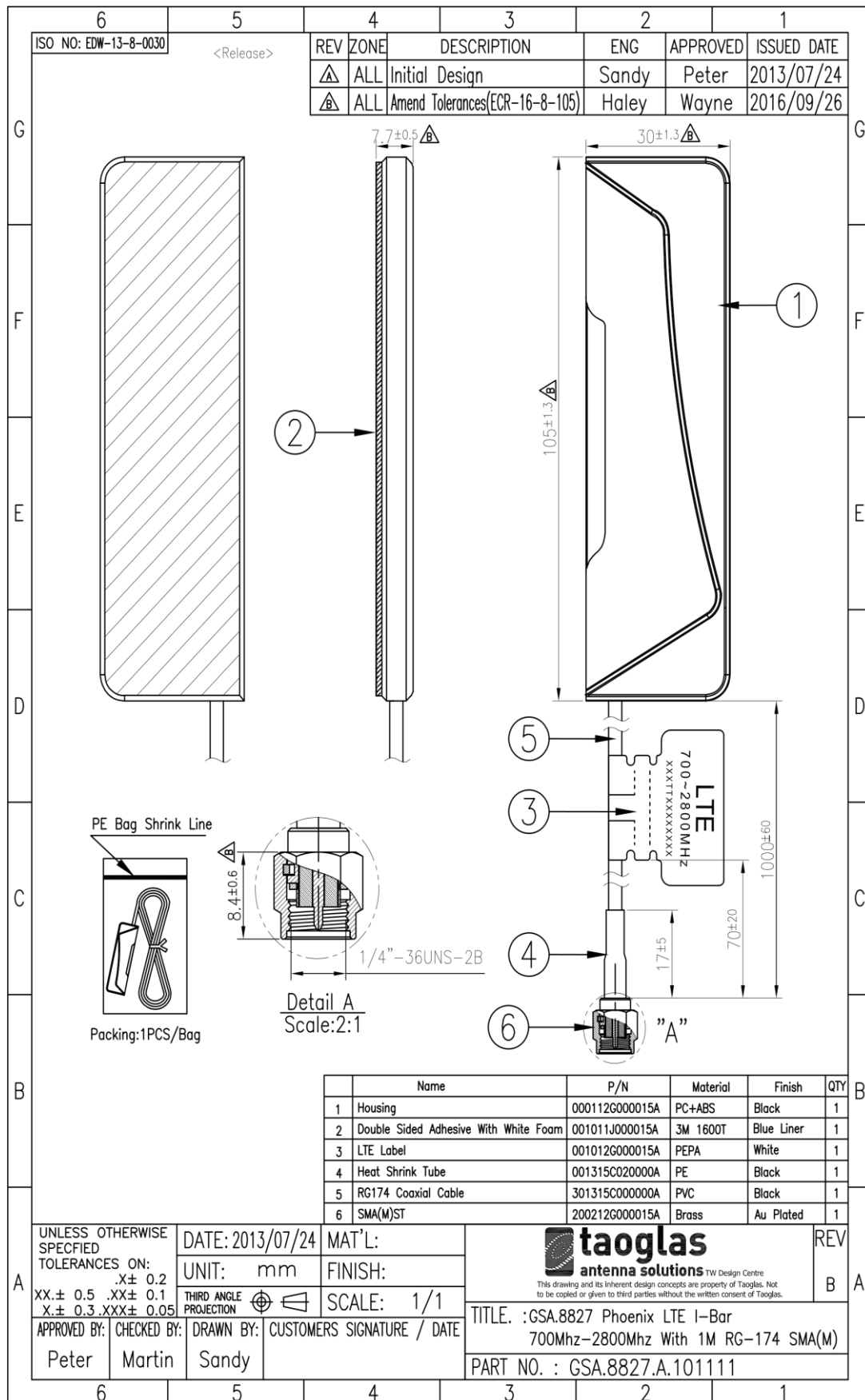

6. Packaging

1pc GSA.8827.A.101111 per PE Bag
 Dimensions: 200*70mm
 Weight: 50g

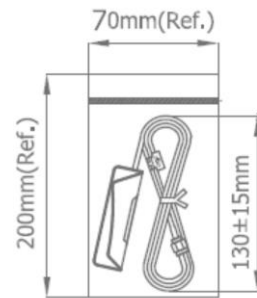

10pcs GSA.8827.A.101111 per Large PE Bag
 Dimensions: 460*260mm
 Weight: 520g

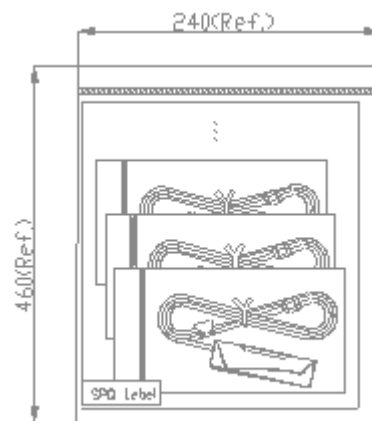

200pcs GSA.8827.A.101111 per Carton
 Dimensions: 400*330*220mm
 Weight: 10.75Kg

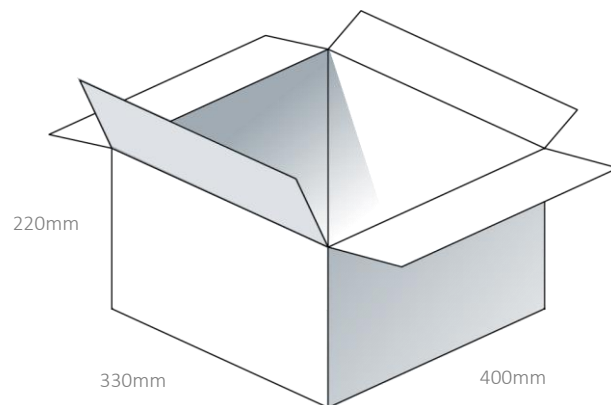

7. Application Note

7.1 Return Loss

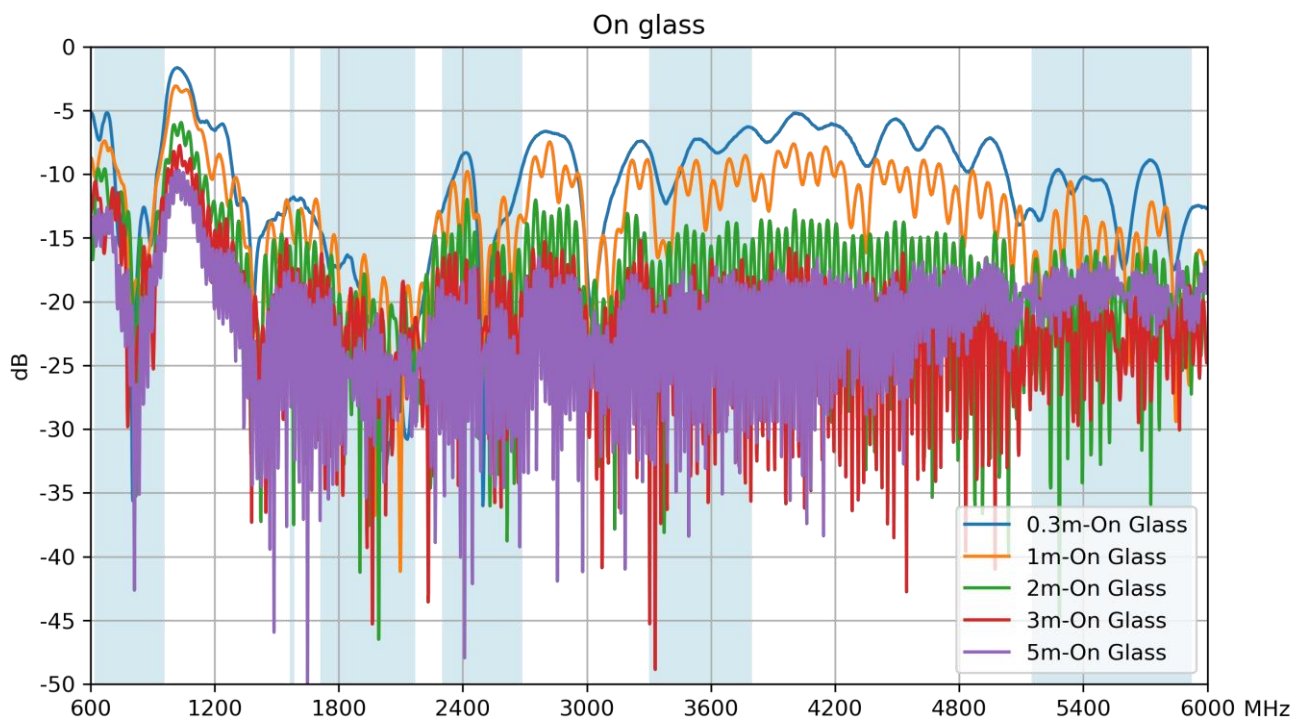
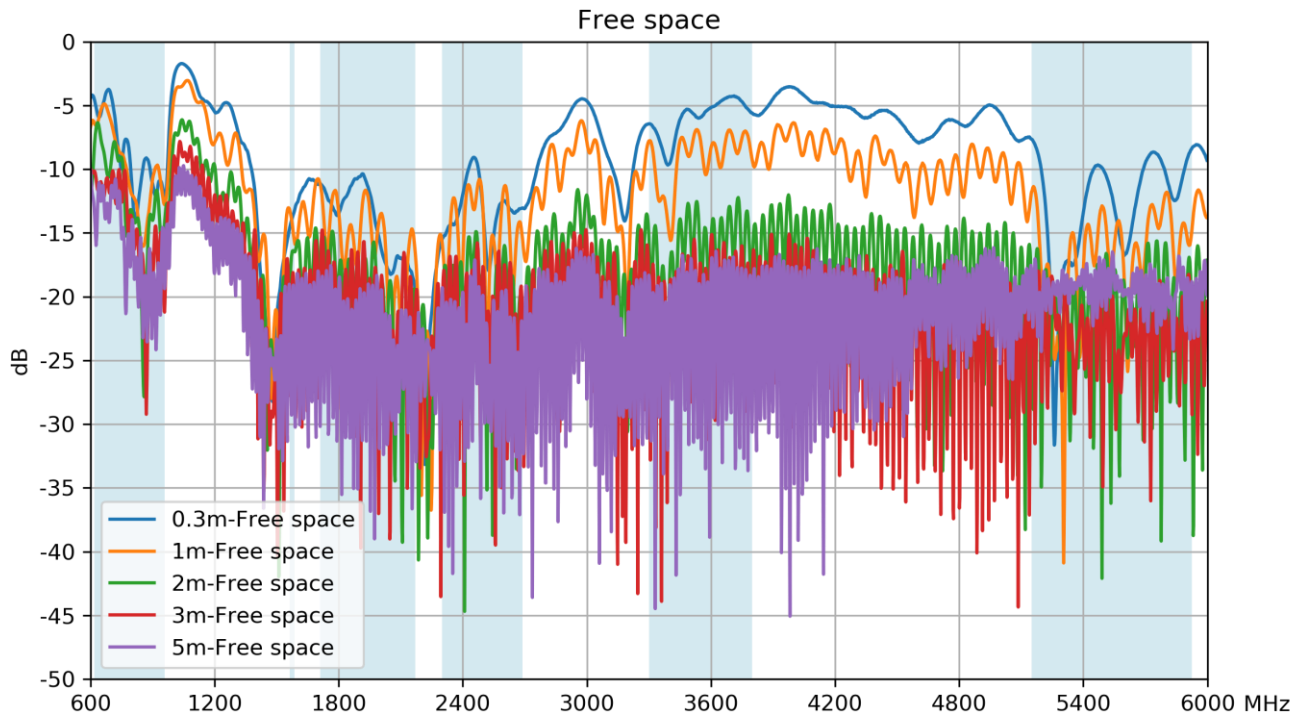

7.2 Efficiency

Free Space

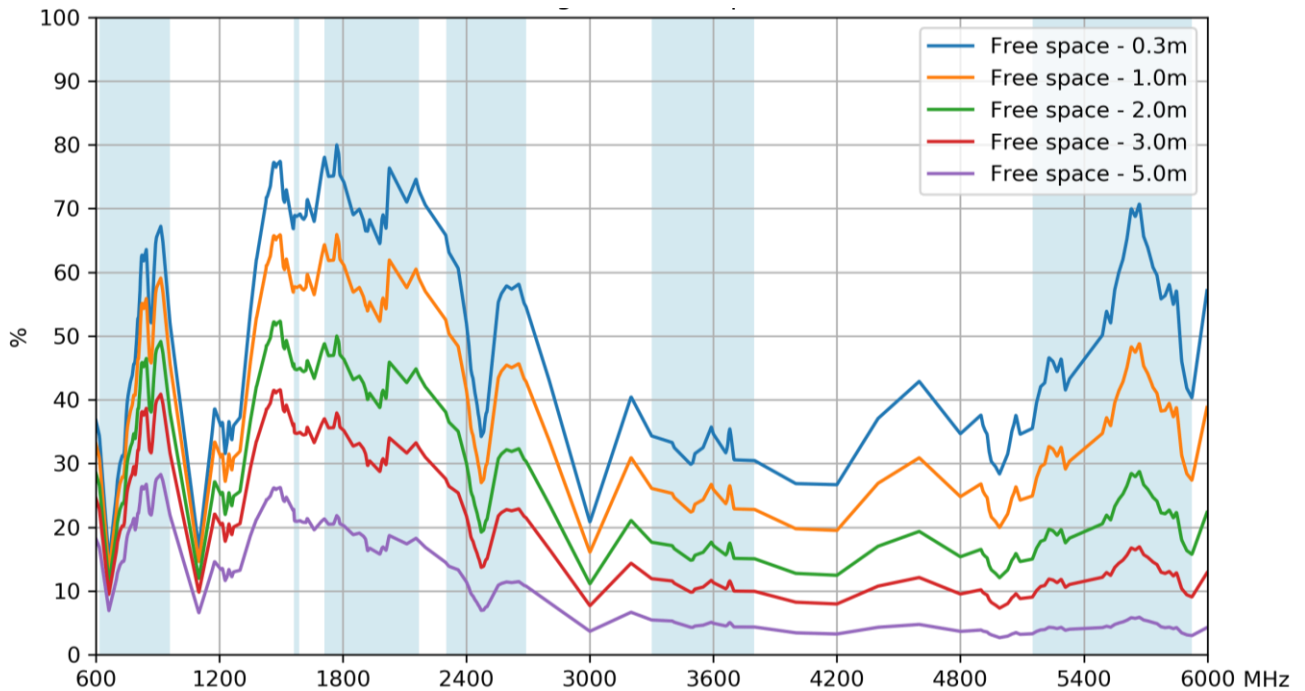

On Glass

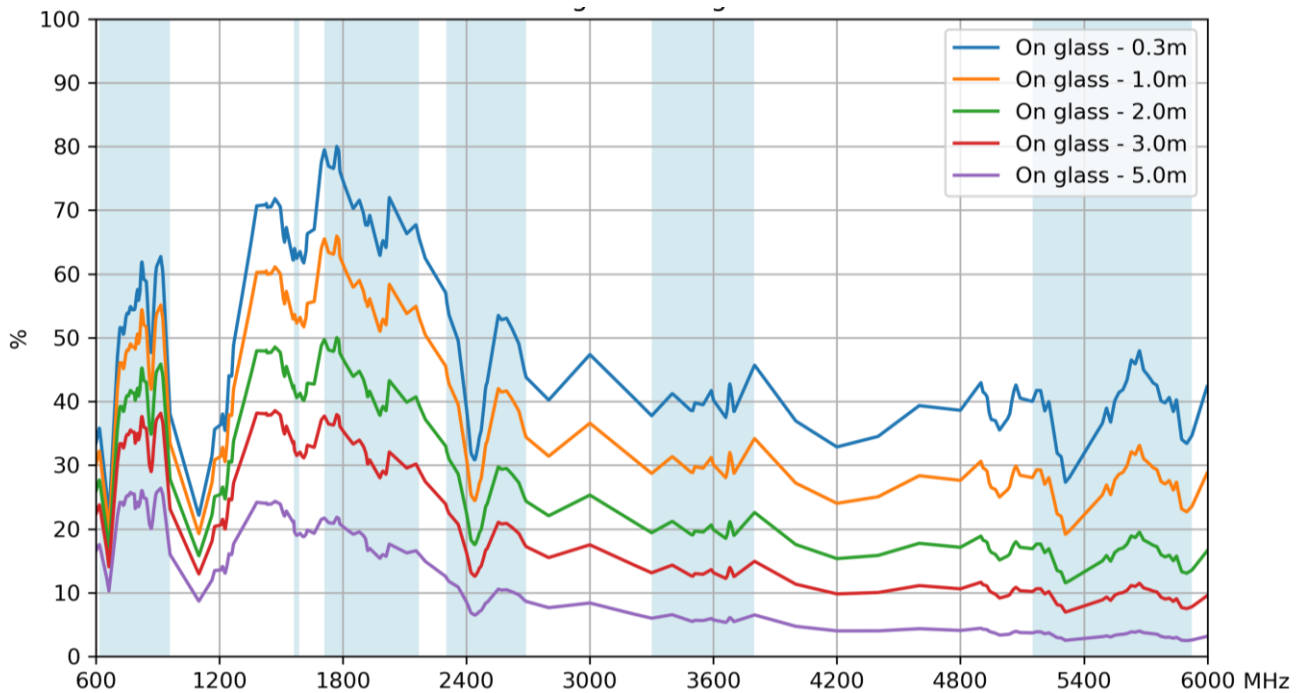

7.3 Average Gain

Free Space

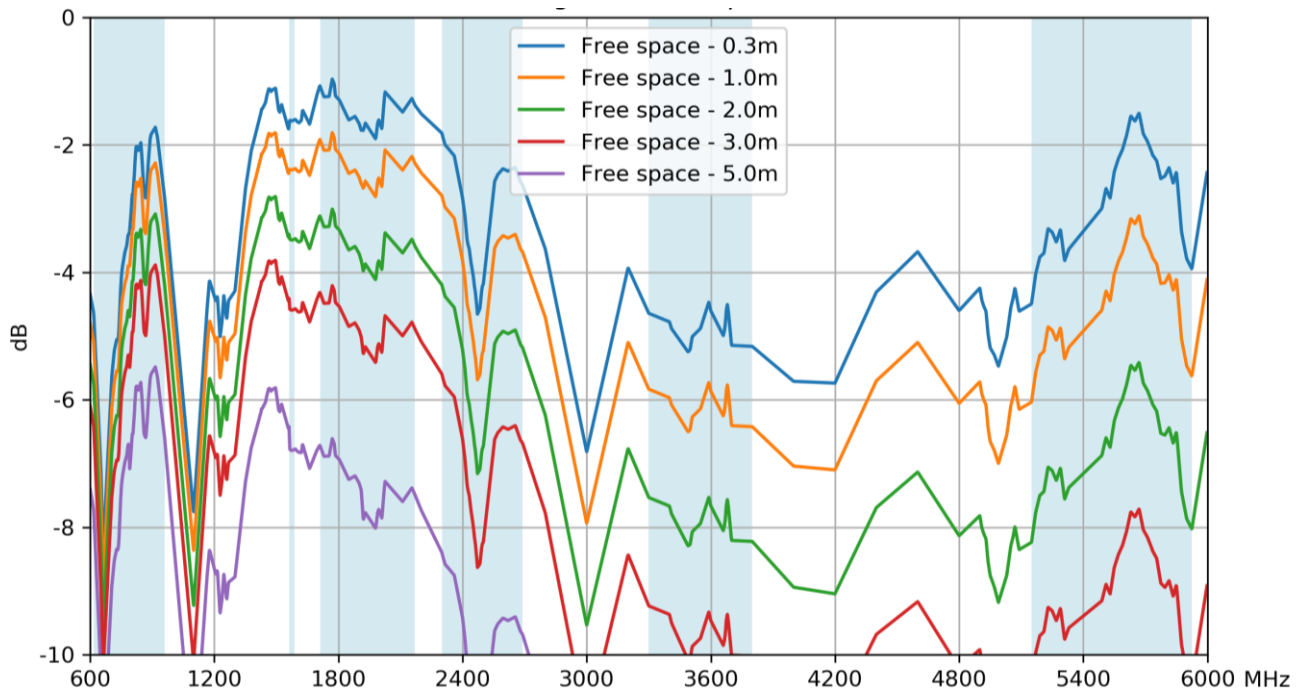

On Glass

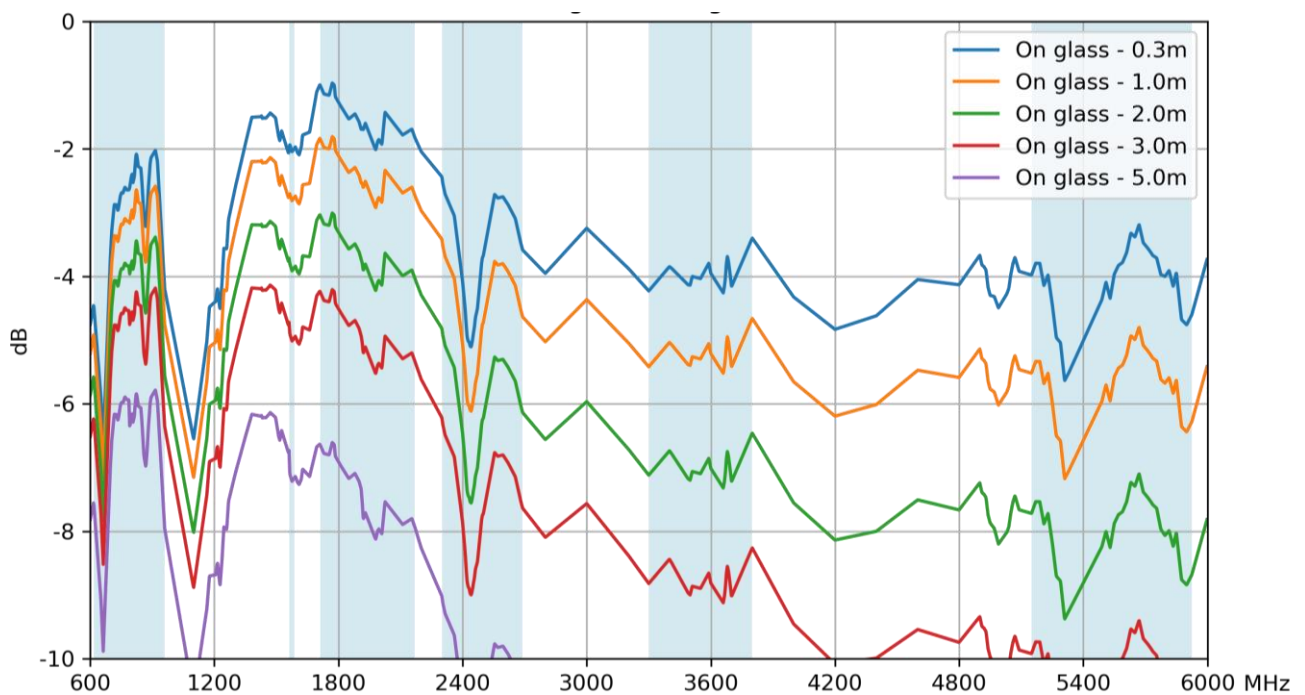

7.4 Peak Gain

Free Space

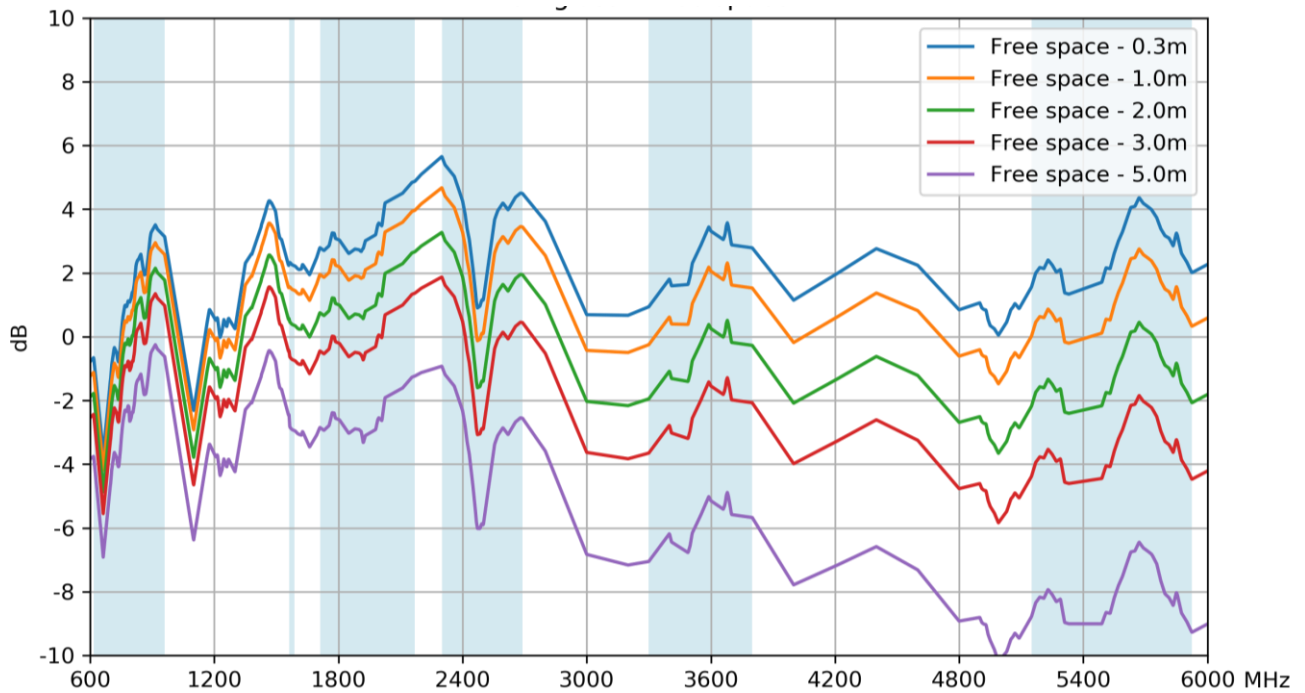

On Glass

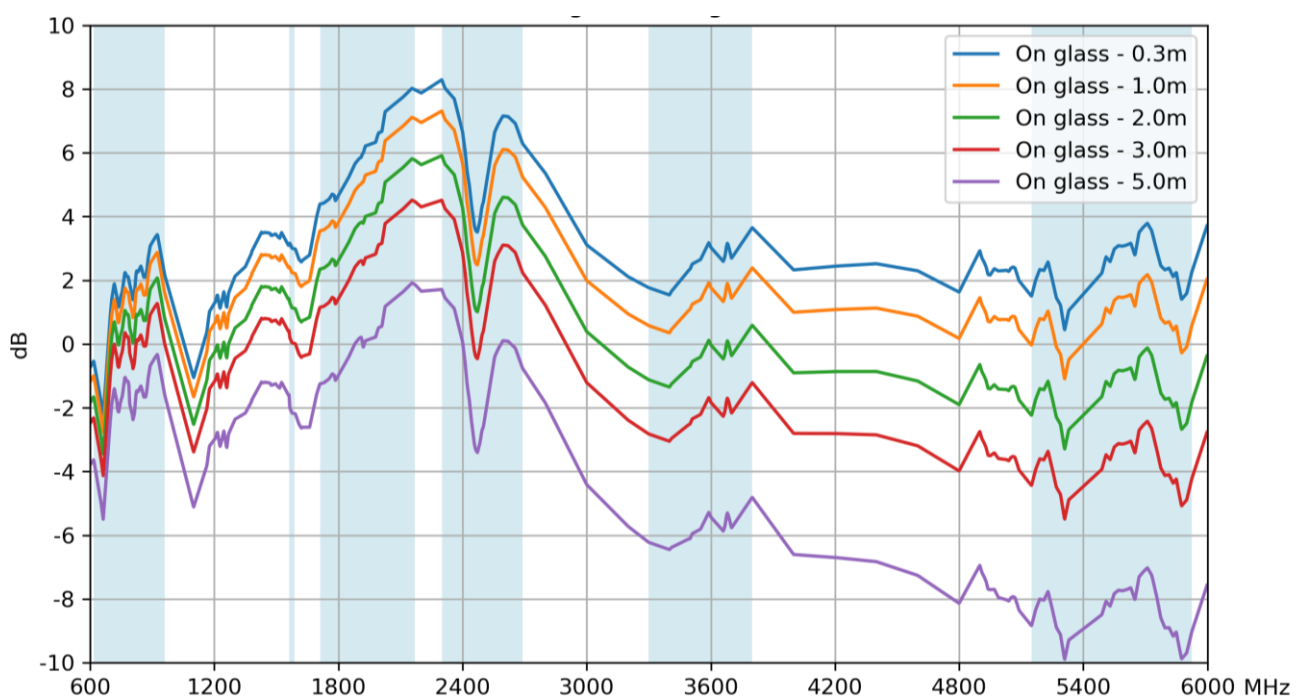

7.5 Performance Table

Electrical											
Frequency (MHz)	5G NR Band 71	LTE700	GSM 850/900	5G NR Band 74, 75, 76	DCS	PCS	UMTS1	LTE2600	5G NR Band 77, 78, 79	LTE5200/Wi-Fi 5800	
	617 ~698	698 ~806	824 ~960	1427 ~1518	1710 ~1880	1850 ~1990	1920 ~2170	2300 ~2690	3300 ~3800	5150 ~5925	
Efficiency (%)											
Free Space	0.3m	23.3	41.9	58.9	62.1	68.9	75.0	67.5	70.1	47.4	32.8
	1.0m	20.8	37.2	51.8	54.6	57.7	61.8	55.2	56.9	37.5	24.6
	2.0m	17.8	31.4	43.1	45.4	44.8	46.9	41.4	42.2	26.9	16.3
	3.0m	15.3	26.5	35.8	37.8	34.7	35.6	31.1	31.3	19.2	10.8
	5.0m	11.2	18.8	24.8	26.1	20.9	20.5	17.5	17.2	9.8	4.8
On glass	0.3m	31.6	53.6	55.2	56.0	63.2	76.1	67.9	66.8	41.0	40.3
	1.0m	28.3	47.7	48.5	49.2	53.0	62.7	55.6	54.2	32.4	30.2
	2.0m	24.2	40.3	40.3	41.0	41.1	47.5	41.7	40.1	23.2	20.0
	3.0m	20.7	34.0	33.5	34.1	31.9	36.1	31.3	29.8	16.6	13.3
	5.0m	15.1	24.3	23.2	23.6	19.2	20.8	17.6	16.4	8.5	5.8
Average Gain (dB)											
Free Space	0.3m	-6.33	-3.78	-2.30	-2.07	-1.62	-1.25	-1.71	-1.54	-3.24	-4.84
	1.0m	-6.81	-4.29	-2.86	-2.63	-2.39	-2.09	-2.58	-2.45	-4.26	-6.09
	2.0m	-7.49	-5.03	-3.66	-3.43	-3.49	-3.29	-3.83	-3.75	-5.71	-7.87
	3.0m	-8.16	-5.77	-4.46	-4.23	-4.59	-4.49	-5.08	-5.05	-7.16	-9.66
	5.0m	-9.52	-7.25	-6.06	-5.83	-6.79	-6.89	-7.57	-7.65	-10.07	-13.22
On glass	0.3m	-5.01	-2.71	-2.58	-2.52	-1.99	-1.19	-1.68	-1.75	-3.88	-3.95
	1.0m	-5.48	-3.22	-3.14	-3.08	-2.76	-2.03	-2.55	-2.66	-4.90	-5.20
	2.0m	-6.17	-3.95	-3.94	-3.88	-3.86	-3.23	-3.80	-3.96	-6.35	-6.98
	3.0m	-6.85	-4.68	-4.74	-4.68	-4.96	-4.43	-5.05	-5.26	-7.81	-8.76
	5.0m	-8.21	-6.15	-6.34	-6.28	-7.16	-6.83	-7.54	-7.86	-10.72	-12.33
Peak Gain (dBi)											
Free Space	0.3m	-0.65	2.31	3.26	3.51	2.33	3.26	3.51	4.88	5.65	3.58
	1.0m	-1.11	1.75	2.70	2.95	1.56	2.42	2.60	3.97	4.67	2.32
	2.0m	-1.77	0.95	1.90	2.15	0.46	1.22	1.30	2.67	3.27	0.52
	3.0m	-2.43	0.15	1.10	1.35	-0.64	0.02	-0.00	1.37	1.87	-1.28
	5.0m	-3.75	-1.45	-0.50	-0.25	-2.84	-2.38	-2.60	-1.23	-0.93	-4.88
On glass	0.3m	0.97	2.29	3.12	3.44	3.16	5.66	6.56	8.02	8.29	3.65
	1.0m	0.48	1.77	2.56	2.88	2.39	4.82	5.65	7.11	7.31	2.39
	2.0m	-0.22	1.07	1.76	2.08	1.29	3.62	4.35	5.81	5.91	0.59
	3.0m	-0.92	0.37	0.96	1.28	0.19	2.42	3.05	4.51	4.51	-1.21
	5.0m	-2.32	-1.03	-0.64	-0.32	-2.01	0.02	0.45	1.91	1.71	-4.81

Changelog for the datasheet

SPE-13-8-025 – GSA.8827.A.101111

Revision: E (Current Version)

Date:	2020-05-08
Changes:	Updated data to cover 5G frequencies Remove IP65
Changes Made by:	Jack Conroy

Previous Revisions

Revision: D

Date:	2009-06-09
Changes:	Packaging Details & Drawing Updated
Changes Made by:	Andy Mahoney

Revision: C

Date:	2016-05-25
Changes:	Packaging Details Updated
Changes Made by:	Aine Doyle

Revision: B

Date:	2014-11-25
Changes:	Packaging Details Updated
Changes Made by:	Aine Doyle

Revision: A (Original First Release)

Date:	2013-04-09
Notes:	
Author:	Technical Writer



TAOGLAS®

www.taoglas.com

