

## SUMMARY

### # Wires

Low voltage 8



*Image is for illustrative purpose only*

Series 2M  
Termination type Female print PCB  
IP rating 68  
AWG wire size 30.00 - 22.00  
Cable Ø 0.00 - 0.00 mm  
Status active  
Matching parts [FMP.2M.308.XLC](#)

### Download

[Request a quote](#)  
[PCB Eagle Pattern](#)  
[PCB Altium Pattern](#)  
[PCB KiCad Pattern](#)  
[Catalog](#)

## TECHNICAL DETAILS

### Mechanics

Shell Style/Model HE\*: Fixed receptacle, nut fixing for printed circuit, watertight  
Keying 3 keys (beta=150, gamma=60, plug: male contacts, receptacle: female contacts)  
Housing Material Aluminium (nickel plated [SAE AMS QQ N 290], anthracite color) shell and nut, other pieces bronze/brass  
Variant P : Watertight  
Weight 11.29 g

### Performance

Configuration 2M.308 : 8 Low Voltage  
Insulator L: PEEK  
Rated Current 10 Amps

### Specifications

Contact Type: Print (straight)  
Contact Dia.: 0.9 mm (0.035in)  
R (max): 4.8 mOhm  
Test voltage (kV rms) Contact-contact: 1.95  
Test voltage (kV rms) Contact-shell: 1.1

*LEMO products and services are provided "as is". LEMO makes no warranties or representations with regard to LEMO product & services or use of them, express, implied or statutory, including for accuracy, completeness, or security. The user is fully responsible for his products and applications using LEMO components.*

## Others

Endurance (Shell): 3000 mating cycles

Temp (min / max): -20°C / +80°C

Humidity (max): 21 days at 95%

Gunfire vibration: 25 Hz - 2000 Hz, 3 axis (Apache helicopter)

Vibration-Sine: 30 g, 3 axes, 12 hr [10 Hz - 2000 Hz]

Vibration-Random: 37.8 g rms - 3 axes, 4 hr amb [50 Hz - 2000 Hz]

Shock Resistance: 300 g [ 3 ms]

Lighting strike EIA 364-75: 10K amps - 6 times

Thermal shock: 5 cycles: -65°C to +150°C

EMI Shielding EIA 364-66A: >= 80 dB (1 GHz), >=70 dB (3 GHz), >= 58 dB (6 GHz), >= 40 dB (10 GHz)

Salt Spray Corrosion: max. 48 hr

## DRAWINGS

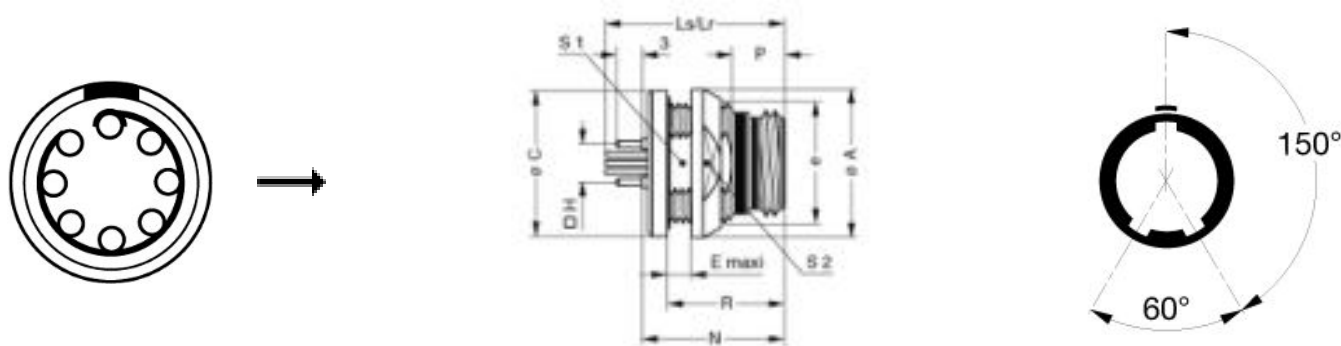

## Dimensions

	A	C	E	H	Lr	Ls	N	P	R	S1	S2	e
mm.	21	20.8	5	8.89	21	20.8	16.8	5.3	13.8	15.5	18	M17x1.00
in.	0,83	0,82	0,20	0,35	0,83	0,82	0,66	0,21	0,54	0,61	0,71	

## RECOMMENDED BY LEMO

### Tools

Spanner wrench: [DCM.65.000.4PA](#)

LEMO products and services are provided "as is". LEMO makes no warranties or representations with regard to LEMO product & services or use of them, express, implied or statutory, including for accuracy, completeness, or security. The user is fully responsible for his products and applications using LEMO components.

*LEMO products and services are provided "as is". LEMO makes no warranties or representations with regard to LEMO product & services or use of them, express, implied or statutory, including for accuracy, completeness, or security. The user is fully responsible for his products and applications using LEMO components.*