



www.seeedstudio.com

www.seeed.cc



[@seeedstudio](https://www.instagram.com/seeedstudio)

ODYSSEY- X86J4105

User Manual

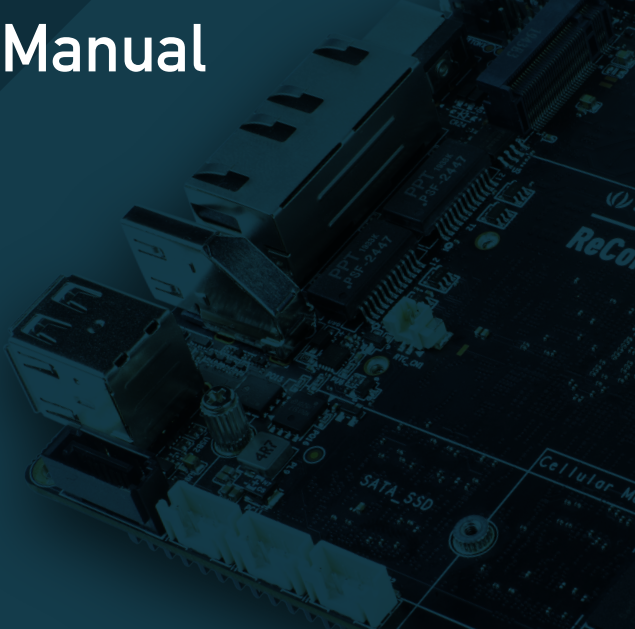

Package Contents

- ODYSSEY - X86J4105
- User Manual
- International Power Adapter
- SATA Cable
- Antenna x2
- RTC Battery
- Heat Sink (Assembled)
- Cooling Fan (Assembled) (Included in EMMC version)

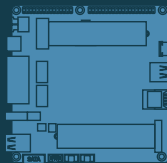

ODYSSEY - X86J4105



User Manual x 1



International Power Adapter x 1



SATA Cable x 1



Antenna x 2



RTC Battery x1



Heat Sink (Assembled) x 1



Cooling Fan (Assembled) x 1

Specifications



Processor	Intel® Celeron® J4105 Frequency: 1.5 – 2.5GHz
Coprocessor	Microchip® ATSAM D21G18 32-Bit ARM® Cortex® M0+
Graphics	Intel® UHD Graphics 600 Frequency: 250 – 750MHz
Memory	LPDDR4 8GB
Storage	64GB eMMC V5.1
Wireless	Wi-Fi 802.11 a/b/g/n/ac @ 2.4/5 GHz HT160 Bluetooth® 5.0
Networking	Intel® I211AT PCIe Gigabit LAN
Audio	Microphone + headphone Combo Connector
Headers	28-pin header from SAM D21G18 40-pin header compatible with Raspberry Pi

USB	USB 2.0 Type-A x2 USB 3.1 Type-A x1 USB 3.1 Type-C x1
Video Interfaces	HDMI2.0a: Up to 4096x2160 @ 60Hz 24bpp DP1.2a: Up to 4096x2160 @ 60Hz 24bpp
Expansion Slots	M.2(Key B, 2242/2280): SATA III, USB2.0, UIM M.2 (Key M, 2242/2280): PCIe 2.0 x4 Micro SD card Socket SIM Card Socket SATA III
RTC	JST 1.0 CR2032 3V
TPM	Built-in TPM (2.0)
Power	DC Jack 5.5/2.1mm or Type-C PD DC Jack input: 12-19V DC Type-C input: USB PD
Dimensions	110x110mm
Certifications	FCC, CE

Quick Start with ODYSSEY - X86J4105

Before you Start

Make sure you have the following:

- 1 An external monitor
- 2 A keyboard and a mouse
- 3 An HDMI Cable

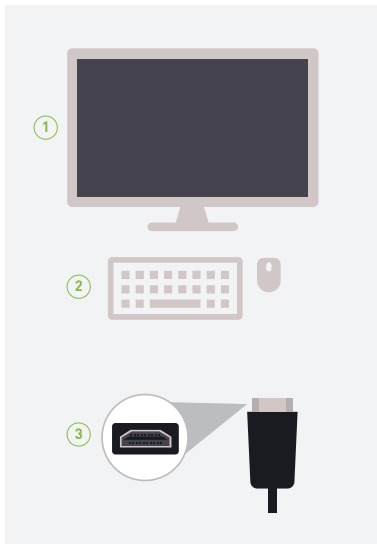

Attaching External Storage

If you have bought the 64GB EMMC storage version of the ODYSSEY - X86J4105, you can skip this step. However, if you need more storage for your needs, feel free to follow this step.

There are four methods of adding storage to ODYSSEY - X86J4105

- 1 Through M.2 PCIE Connector
- 2 Through M.2 SATA connector
- 3 Through SATA Connector
- 4 Through Micro-SD Card Slot

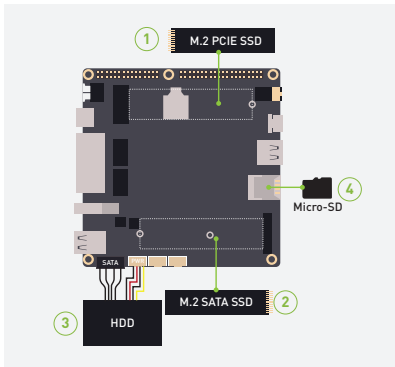

Note: Only three storage types support to install an operating system inside (M.2 SATA, M.2 PCIE and SATA), and the Micro SD Card can only be used as external storage.

Connecting Antennas

Insert the two antennas into the two sockets on the ODYSSEY - X86J4105

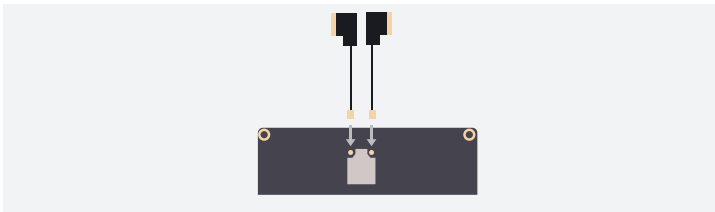

Note: One antenna is for Wi-Fi and Bluetooth whereas the second antenna is for strong 5G connectivity

Connecting to a display

1. There are two ways to connect your ODYSSEY - X86J4105 to an external display

Method 1

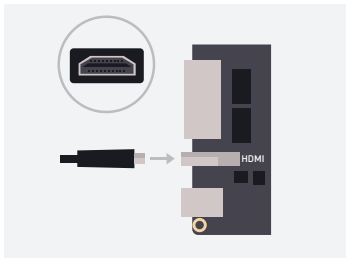

Method 2

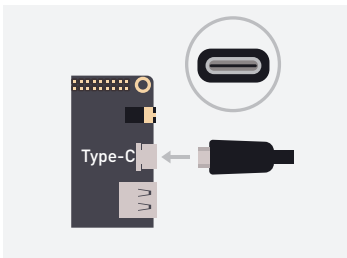

Connecting to a keyboard and a mouse

Connect your favorite keyboard and mouse to the ODYSSEY - X86J4105 through any of the USB connectors

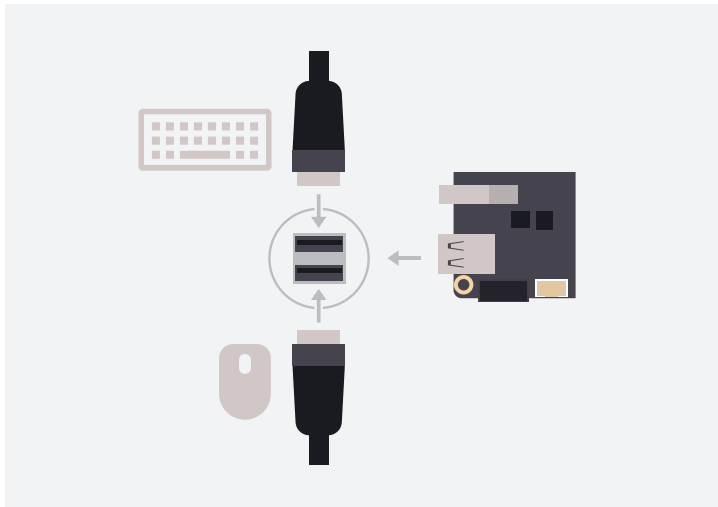

Powering up

1. There are two ways to power up your ODYSSEY - X86J4105.

Method 1

Use the 12V/2A power adapter (provided)

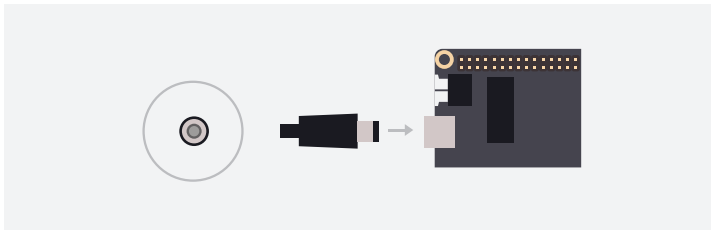

Method 2

Use a USB Type-C Cable (Supports DP)

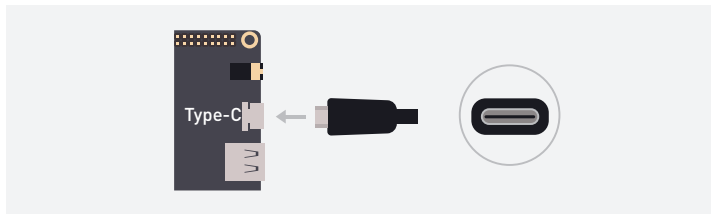

2. Press the power button and you will notice the blue power LED turn on

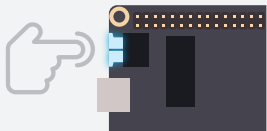

3. Wait a few seconds until it boots into the operating system.

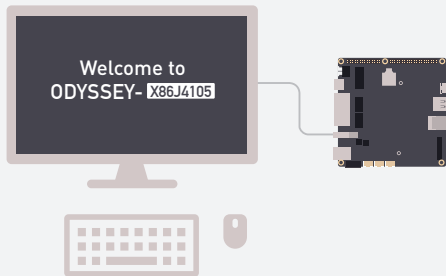

Installing an Operating System

ODYSSEY - X86J4105 supports both Windows and Linux operating systems. If you have bought the non EMMC version, you could attach an external storage by following the previous steps and install your desired operating system by creating a bootable USB drive. Also, if you have bought the EMMC version with windows pre-installed, you could additionally install Linux according to your requirements.

Step 1

Connect your bootable USB drive into one of the USB ports on the ODYSSEY - X86J4105.

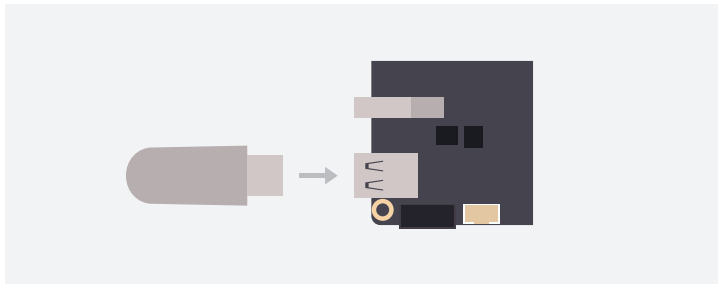

Step 2

Press the power button and keep pressing F7 key on the keyboard until you see the Boot Manager screen.

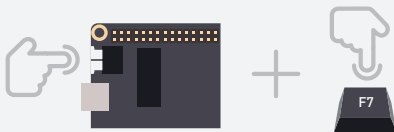

Step 3

Select the connected USB Drive as the boot drive and press enter

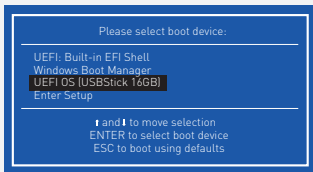

Step 4

Then follow the instructions on the installation screen to complete installing your desired operating system.

Adding 4G Cellular Connectivity

Step 1

Insert a Micro-SIM Card to the bottom layer of the slot.

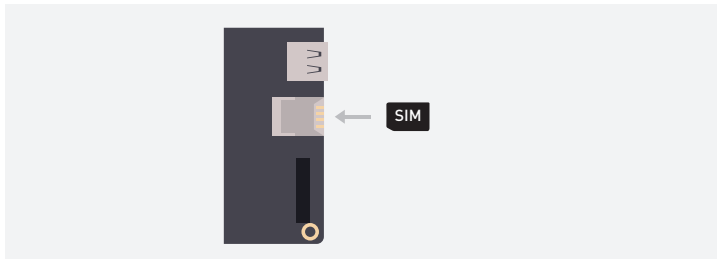

Step 2

Insert a PCIE 4G module.

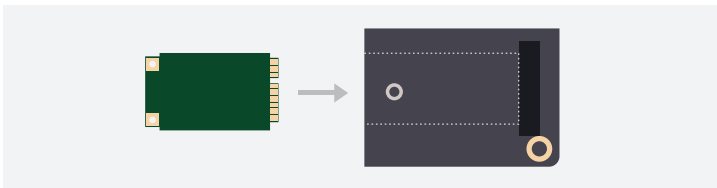

Note: This module is a must have if you want to use the connected SIM card.

Pinout diagram

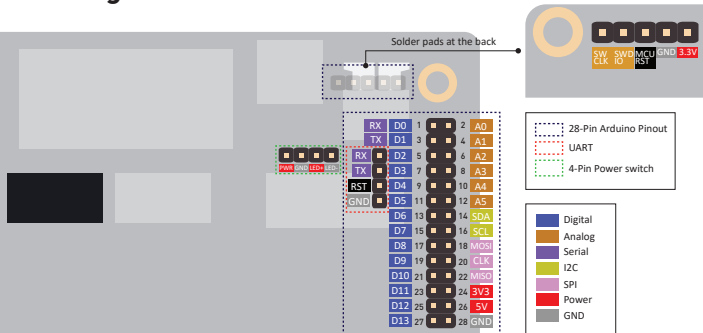

ODYSSEY- X86J4105

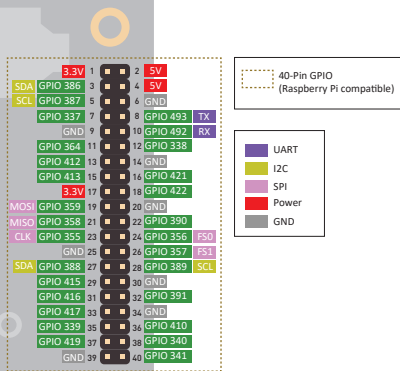

FAQ

Q: How can I access the BIOS setup?

A: Press the Power Button and keep pressing DEL key until you see the BIOS Setup.

Q: Arduino IDE doesn't recognize the onboard microcontroller

A: Add a jumper wire between pins 3 and 4 of UART pins on the 28-pin header to reset the AMSAMDG21.

Q: I cannot connect to Wi-Fi and Bluetooth

A: Check BIOS settings and enable Wi-Fi and Bluetooth from BIOS.

Q: ODYSSEY - X86J4105 doesn't power up

A: Make sure you use the 12V/2A power adapter provided in the box and check the connection.

- If you have any further questions, please visit forum.seeedstudio.com or send an email to techsupport@seeed.cc