

CARMEN-SS-C

~12° smooth spot beam. Assembly with holder C compatible with LEDiL HEKLA. Updated version with good colour mixing capability.

TECHNICAL SPECIFICATIONS:

Dimensions	Ø 69.5 mm
Height	41.5 mm
Fastening	socket
ROHS compliant	yes ⓘ



MATERIAL SPECIFICATIONS:

Component	Type	Material	Colour	Finish
CARMEN-SS	Single lens	PMMA	clear	
CARMEN-HLD-C	Holder	PC	black	

ORDERING INFORMATION:

Component	Type	Qty in box	MOQ	MPQ	Box weight (kg)
CP16601_CARMEN-SS-C	Single lens	150	150	15	8.4
» Box size: 480 x 280 x 300 mm					

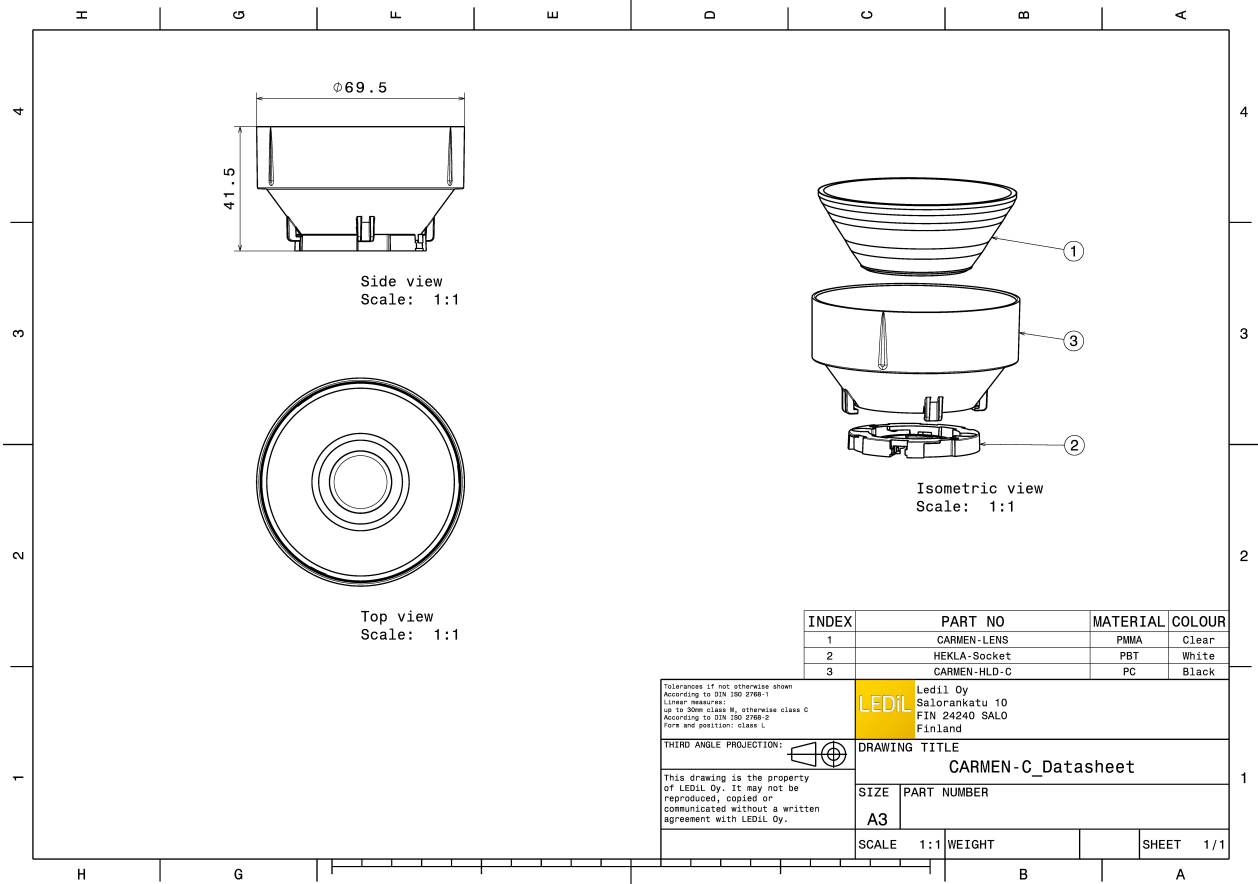

See also our general installation guide: www.ledil.com/installation_guide

PHOTOMETRIC DATA (MEASURED):

bridgelux.

LED Vesta TW 6mm DP
 FWHM / FWTM 11.0° / 21.0°
 Efficiency 60 %
 Peak intensity 11 cd/lm
 LEDs/each optic 1
 Light colour White

Required components:
 C16142_HEKLA-SOCKET-K
 Bender Wirth: 504 Typ L8



bridgelux.

LED Vesta TW 9mm (9W) DP
 FWHM / FWTM 13.0° / 25.0°
 Efficiency 58 %
 Peak intensity 7 cd/lm
 LEDs/each optic 1
 Light colour White

Required components:
 C16142_HEKLA-SOCKET-K
 Bender Wirth: 489 Typ L8

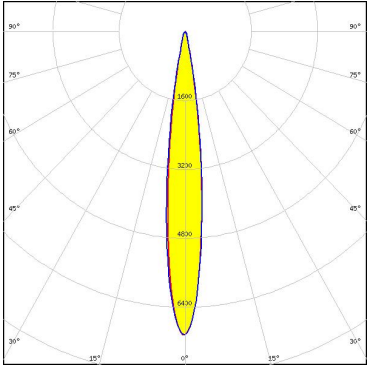
CITIZEN

LED CLL02x/CLU02x (LES10)
 FWHM / FWTM 13.0° / 25.0°
 Efficiency 61 %
 Peak intensity 8 cd/lm
 LEDs/each optic 1
 Light colour White

Required components:
 F15255_HEKLA-SOCKET-C

CITIZEN

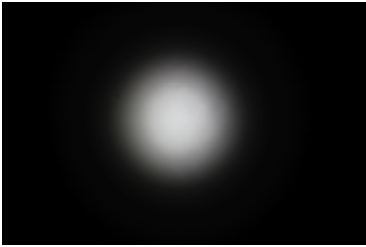
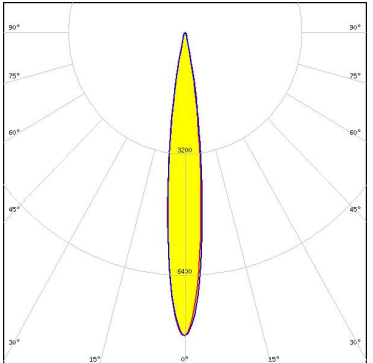
LED CLU700/701/702
 FWHM / FWTM 10.0° / 20.0°
 Efficiency 64 %
 Peak intensity 13.9 cd/lm
 LEDs/each optic 1
 Light colour White

Required components:
 F15255_HEKLA-SOCKET-C



PHOTOMETRIC DATA (MEASURED):

CITIZEN

LED CLU710/711
 FWHM / FWTM 12.0° / 24.0°
 Efficiency 60 %
 Peak intensity 8.8 cd/lm
 LEDs/each optic 1
 Light colour White
 Required components:
 F15859_HEKLA-SOCKET-I

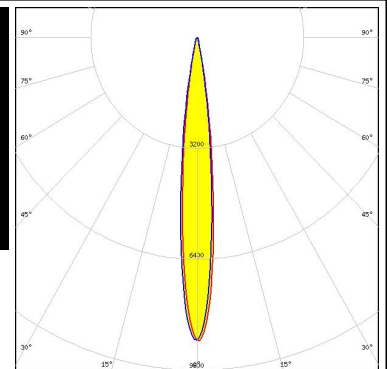

CITIZEN

LED CLU7B2
 FWHM / FWTM 10.0° / 18.0°
 Efficiency 66 %
 Peak intensity 15.6 cd/lm
 LEDs/each optic 1
 Light colour White
 Required components:
 F15255_HEKLA-SOCKET-C

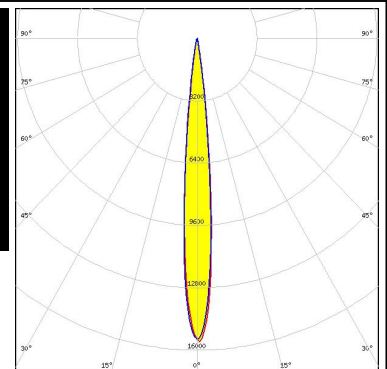
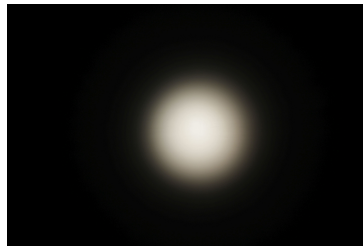

CREE LED

LED CXA/B 13xx
 FWHM / FWTM 11.0° / 20.0°
 Efficiency 66 %
 Peak intensity 13.8 cd/lm
 LEDs/each optic 1
 Light colour White
 Required components:
 F15956_HEKLA-SOCKET-J

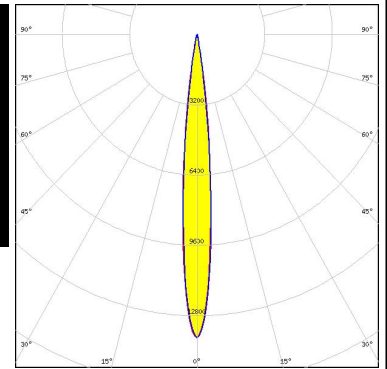
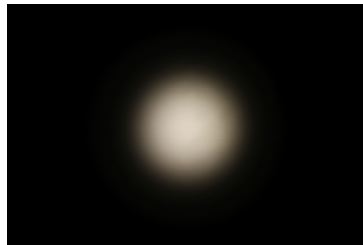





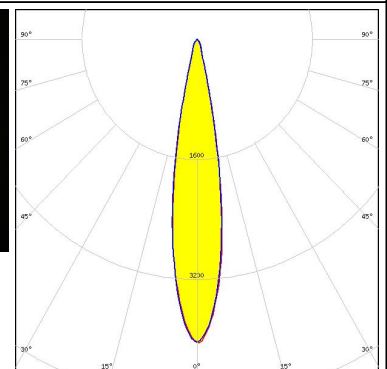
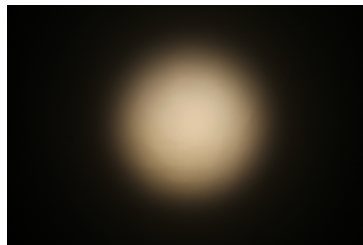

LUMILEDS

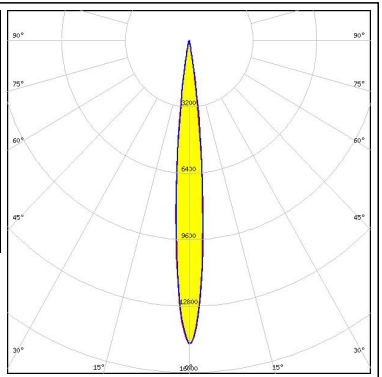

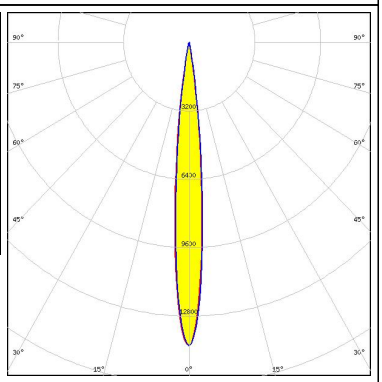

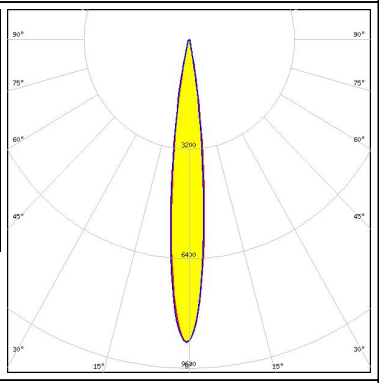

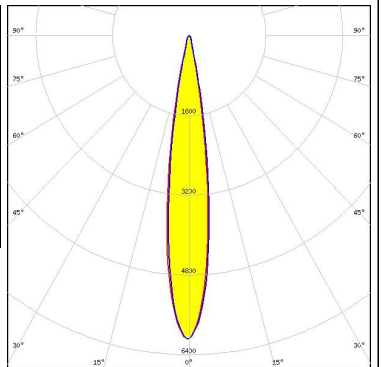
LED LUXEON CX Plus CoB L08 (Gen2)
 FWHM / FWTM 19.0° / 32.0°
 Efficiency 57 %
 Peak intensity 4 cd/lm
 LEDs/each optic 1
 Light colour White
 Required components:
 Bender Wirth: 637a Hekla



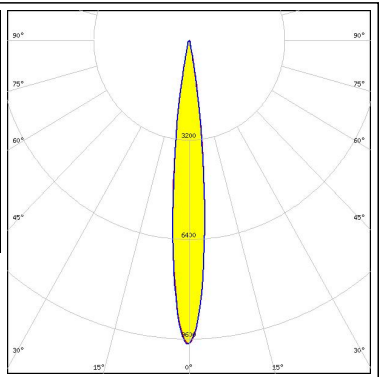

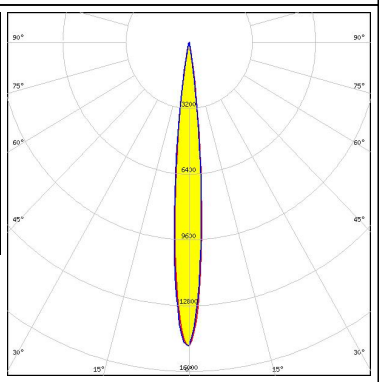

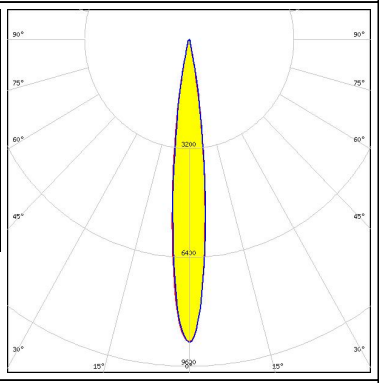
PHOTOMETRIC DATA (MEASURED):

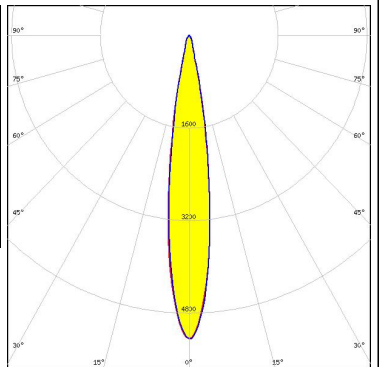
<p>LUMILEDS</p> <p>LED LUXEON CX Plus CoB - HD S01H4</p> <p>FWHM / FWTM 11.0° / 19.0°</p> <p>Efficiency 65 %</p> <p>Peak intensity 14.6 cd/lm</p> <p>LEDs/each optic 1</p> <p>Light colour White</p> <p>Required components: Bender Wirth: 634c Hekla</p>		
<p>LUMILEDS</p> <p>LED LUXEON CX Plus CoB - HD S01H6 / HD S02H6</p> <p>FWHM / FWTM 11.0° / 19.0°</p> <p>Efficiency 64 %</p> <p>Peak intensity 14.2 cd/lm</p> <p>LEDs/each optic 1</p> <p>Light colour White</p> <p>Required components: Bender Wirth: 634c Hekla</p>		
<p>LUMILEDS</p> <p>LED LUXEON CX Plus CoB - HD S04H9</p> <p>FWHM / FWTM 13.0° / 24.0°</p> <p>Efficiency 61 %</p> <p>Peak intensity 8.9 cd/lm</p> <p>LEDs/each optic 1</p> <p>Light colour White</p> <p>Required components: Bender Wirth: 634c Hekla</p>		
<p>LUMILEDS</p> <p>LED LUXEON CX Plus CoB L04 / L05 (Gen2)</p> <p>FWHM / FWTM 16.0° / 27.0°</p> <p>Efficiency 60 %</p> <p>Peak intensity 6.1 cd/lm</p> <p>LEDs/each optic 1</p> <p>Light colour White</p> <p>Required components: Bender Wirth: 637a Hekla</p>		

PHOTOMETRIC DATA (MEASURED):

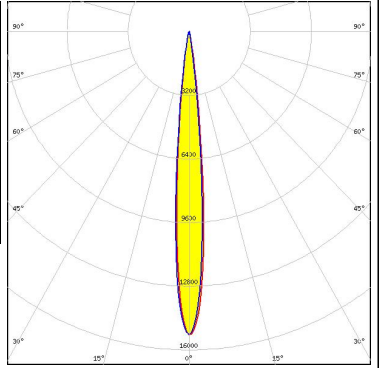
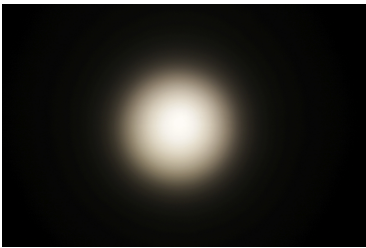
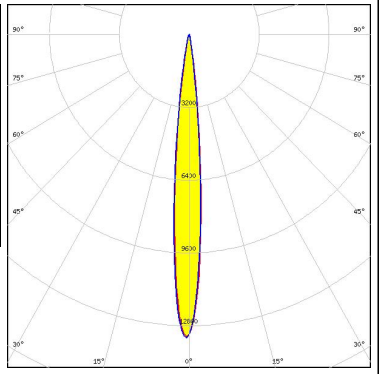
<p>LUMILEDS</p> <p>LED LUXEON CX Plus CoB M02 / M03 (Gen2)</p> <p>FWHM / FWTM 12.0° / 23.0°</p> <p>Efficiency 62 %</p> <p>Peak intensity 9.8 cd/lm</p> <p>LEDs/each optic 1</p> <p>Light colour White</p> <p>Required components: Bender Wirth: 641a Hekla</p>		
<p>LUMILEDS</p> <p>LED LUXEON CX Plus CoB S01 (Gen2)</p> <p>FWHM / FWTM 10.0° / 19.0°</p> <p>Efficiency 65 %</p> <p>Peak intensity 14.8 cd/lm</p> <p>LEDs/each optic 1</p> <p>Light colour White</p> <p>Required components: Bender Wirth: 634c Hekla</p>		
<p>LUMINUS</p> <p>LED CDM-9 (Dim-To-Warm)</p> <p>FWHM / FWTM 13.0° / 23.0°</p> <p>Efficiency 60 %</p> <p>Peak intensity 8.9 cd/lm</p> <p>LEDs/each optic 1</p> <p>Light colour White</p> <p>Required components: C16142_HEKLA-SOCKET-K Bender Wirth: 490 Typ L8</p>		
<p>LUMINUS</p> <p>LED CxM-11 (19x19)</p> <p>FWHM / FWTM 16.0° / 29.0°</p> <p>Efficiency 58 %</p> <p>Peak intensity 5.3 cd/lm</p> <p>LEDs/each optic 1</p> <p>Light colour White</p> <p>Required components: F15859_HEKLA-SOCKET-I</p>		

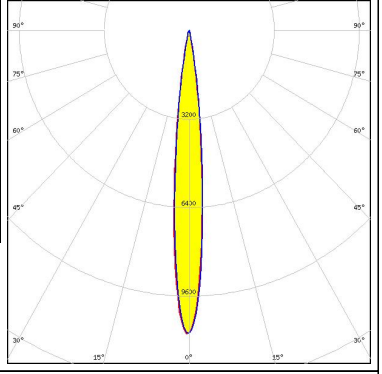
PHOTOMETRIC DATA (MEASURED):

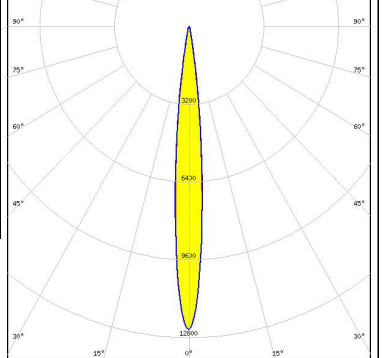
<p>LUMINUS</p> <p>LED CXM-3 FWHM / FWTM 10.0° / 18.0° Efficiency 66 % Peak intensity 15.2 cd/lm LEDs/each optic 1 Light colour White Required components: F15255_HEKLA-SOCKET-C</p>		
<p>LUMINUS</p> <p>LED CXM-4 FWHM / FWTM 10.0° / 19.0° Efficiency 63 % Peak intensity 13.4 cd/lm LEDs/each optic 1 Light colour White Required components: F15255_HEKLA-SOCKET-C</p>		
<p>NICHIA</p> <p>LED NJCWL024Z-V1MT: COB L-Type Tunable White FWHM / FWTM 11.0° / 21.0° Efficiency 58 % Peak intensity 11 cd/lm LEDs/each optic 1 Light colour White Required components: C16142_HEKLA-SOCKET-K Bender Wirth: 497 Typ L8</p>		
<p>XICATO</p> <p>LED XOB 6 mm FWHM / FWTM 10.0° / 20.0° Efficiency 62 % Peak intensity 12.5 cd/lm LEDs/each optic 1 Light colour White Required components: F15255_HEKLA-SOCKET-C</p>		

PHOTOMETRIC DATA (MEASURED):

XICATO

LED XOB 9.8 mm
FWHM / FWTM 13.0° / 24.0°
Efficiency 60 %
Peak intensity 8.2 cd/lm
LEDs/each optic 1
Light colour White
Required components:
F15255_HEKLA-SOCKET-C

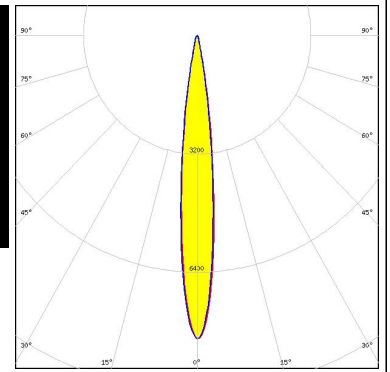
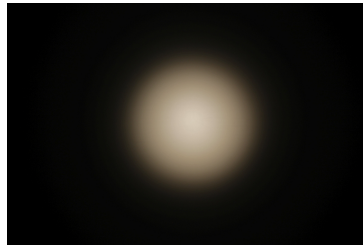

PHOTOMETRIC DATA (SIMULATED):

<p>bridgelux</p> <p>LED VERO13 FWHM / FWTM 16.0° / 34.0° Efficiency 65 % Peak intensity 4.6 cd/lm LEDs/each optic 1 Light colour White Required components: C16142_HEKLA-SOCKET-K</p>	
<p>CITIZEN</p> <p>LED CLL02x/CLU02x (LES10) FWHM / FWTM 14.0° / 26.0° Efficiency 45 % Peak intensity 6.8 cd/lm LEDs/each optic 1 Light colour White Required components: F15859_HEKLA-SOCKET-I C16752_CARMEN-70-SHD</p>	
<p>CITIZEN</p> <p>LED CLU700/701/702 FWHM / FWTM 10.0° / 19.0° Efficiency 51 % Peak intensity 14.2 cd/lm LEDs/each optic 1 Light colour White Required components: F15255_HEKLA-SOCKET-C C16752_CARMEN-70-SHD</p>	
<p>CITIZEN</p> <p>LED CLU712 FWHM / FWTM 12.0° / 24.0° Efficiency 47 % Peak intensity 8.1 cd/lm LEDs/each optic 1 Light colour White Required components: F15859_HEKLA-SOCKET-I C16752_CARMEN-70-SHD</p>	

PHOTOMETRIC DATA (SIMULATED):

CITIZEN

LED CLU712
 FWHM / FWTM 12.0° / 24.0°
 Efficiency 65 %
 Peak intensity 9.8 cd/lm
 LEDs/each optic 1
 Light colour White
 Required components:
 F15859_HEKLA-SOCKET-I

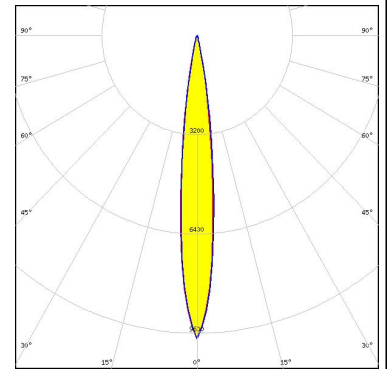

CREE LED

LED CMA1825
 FWHM / FWTM 17.0° / 32.0°
 Efficiency 69 %
 Peak intensity 5.4 cd/lm
 LEDs/each optic 1
 Light colour White
 Required components:

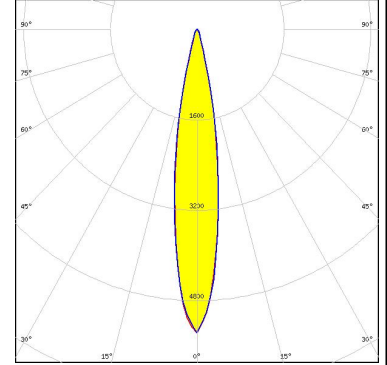

CREE LED

LED CMA1840
 FWHM / FWTM 19.0° / 37.0°
 Efficiency 66 %
 Peak intensity 4 cd/lm
 LEDs/each optic 1
 Light colour White
 Required components:

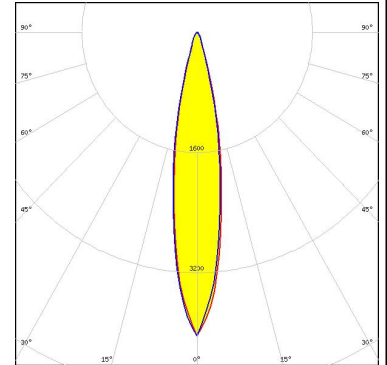

CREE LED

LED CXA/B 15xx
 FWHM / FWTM 12.0° / 23.0°
 Efficiency 68 %
 Peak intensity 11.1 cd/lm
 LEDs/each optic 1
 Light colour White
 Required components:
 F15256_HEKLA-SOCKET-D

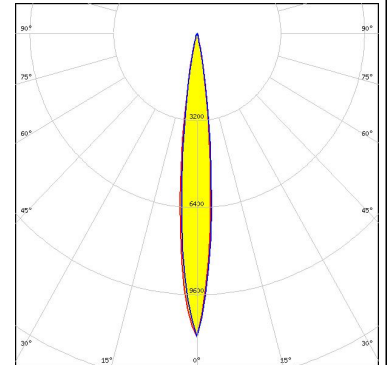

PHOTOMETRIC DATA (SIMULATED):



LED CXM-4
FWHM / FWTM 8.0° / 18.0°
Efficiency 52 %
Peak intensity 16.8 cd/lm
LEDs/each optic 1
Light colour White
Required components:
 F17435_HEKLA-G2-C
 C16752_CARMEN-70-SHD

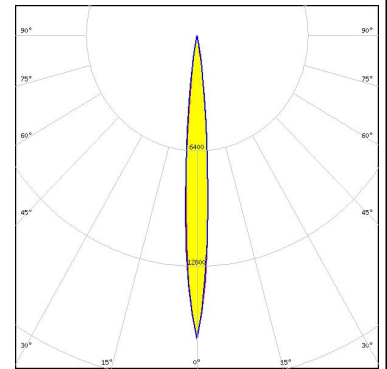

LED CxM-6 (13.5x13.5)
FWHM / FWTM 10.0° / 20.0°
Efficiency 68 %
Peak intensity 14.7 cd/lm
LEDs/each optic 1
Light colour White
Required components:
 F17435_HEKLA-G2-C

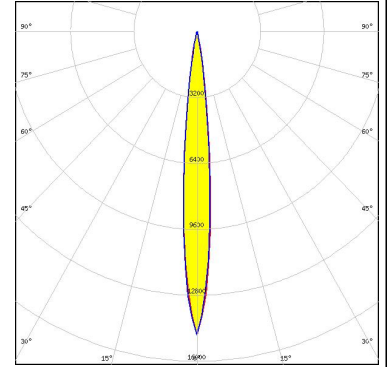

LED LC003D / LC006D / LC009D / LC013D
FWHM / FWTM 14.0° / 26.0°
Efficiency 63 %
Peak intensity 8 cd/lm
LEDs/each optic 1
Light colour White
Required components:
 F17435_HEKLA-G2-C

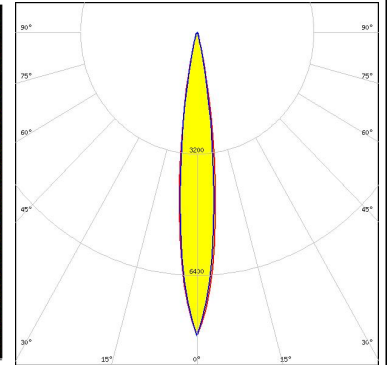

LED LC003D / LC006D / LC009D / LC013D
FWHM / FWTM 14.0° / 26.0°
Efficiency 62 %
Peak intensity 7.5 cd/lm
LEDs/each optic 1
Light colour White
Required components:
 F17435_HEKLA-G2-C

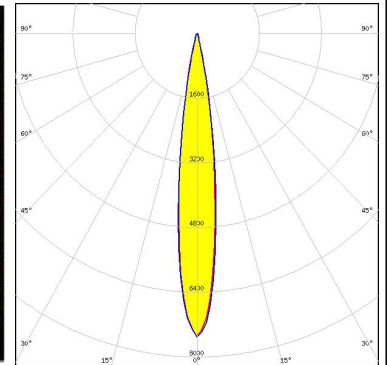
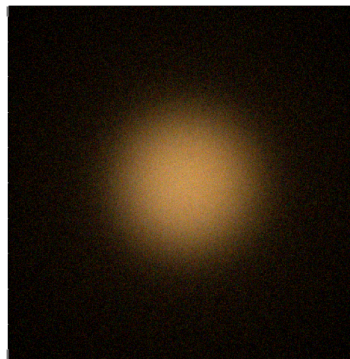

PHOTOMETRIC DATA (SIMULATED):

SAMSUNG

LED LC010C
FWHM / FWTM 10.0° / 20.0°
Efficiency 68 %
Peak intensity 15 cd/lm
LEDs/each optic 1
Light colour White
Required components:
F17435_HEKLA-G2-C

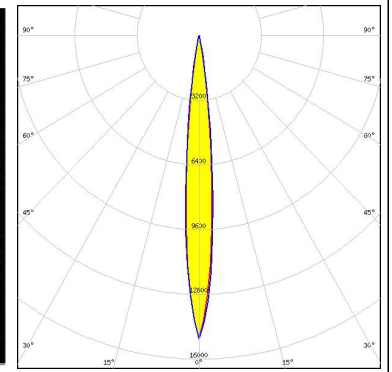

GENERAL INFORMATION:

NOTE: The typical beam angle will be changed by different color, chip size and chip position tolerance. The typical total beam angle is the full angle measured where the luminous intensity is half of the peak value.

Due to use of high power COB's with this product, special attention to proper thermal design is highly recommended. LEDiL has no liability for direct, indirect or consecutive damages arising from the LEDiL products being used outside of the recommended temperature range.

MATERIALS:

As part of our continuous research and improvement processes, and to ensure the best possible quality and availability of our products, LEDiL reserves the right to change material grades without notice.

PRODUCT DATA USER AGREEMENT AND DISCLAIMER:

The measured data in the provided downloadable LEDiL Product Datasheets and Mechanical 2D-Drawings is rounded and provided as reference for planning. LEDiL Oy's optical specifications have been verified by conducting performance testing of the products in accordance with the company's quality system. The reported data are averaged results of multiple measurements with typical variation. LEDiL Oy reserves the right to without prior notification make changes and improvements to its products.

LEDiL Oy assumes neither warranty, nor guarantee nor any other liability of any kind for the contents and correctness of the provided data. The provided data has been generated with highest diligence but the provided data may in reality not represent the complete possible variation range of all intrinsic parameters. Therefore, in certain cases a deviation from the provided data could occur.

LEDiL Oy reserves the right to undertake technical changes of its products without further notification which could lead to changes in the provided data. LEDiL Oy assumes no liability of any kind for the possible deviation from any provided data or any other damage resulting from the usage of the provided data.

The user agrees to this disclaimer and user agreement with the download or usage of the provided files.

LEDiL Oy

Joensuunkatu 13
FI-24240 SALO
Finland

LEDiL Inc.

228 West Page Street
Suite D
Sycamore IL 60178
USA

Ledil Optics Technology (Shenzhen) Co., Ltd.

405 , Block B
Casic Motor Building
Shenzhen 518057
P.R.CHINA

Local sales and technical support

[www.ledil.com/
where_to_buy](http://www.ledil.com/where_to_buy)

Shipping locations

Salo, Finland
Hong Kong, China

Distribution Partners

[www.ledil.com/
where_to_buy](http://www.ledil.com/where_to_buy)