

# SLDN-06D1A

## Non-Isolated DC-DC Converter

The SLDN-06D1A modules are non-isolated dc-dc converters that deliver up to 6 A of output current. These modules operate over a wide range of input voltage (3 -14.4 VDC) and provide a precisely regulated output voltage from 0.45 to 5.5 VDC, programmable via an external resistor and further adjustable through power management bus.

Features include a digital interface using the power management bus protocol, remote on/off, adjustable output voltage, over current and over temperature protection. The power management bus interface supports a range of commands to control and monitor the module.

The Tunable Loop™ feature allows the user to optimize the dynamic response of the converter to match the load with reduced amount of output capacitance leading to savings on cost and PWB area.



### Key Features & Benefits

- 3 - 14.4 VDC Input
- 0.45 VDC @ 6 A Output
- Wide Input Voltage Range
- Fixed Switching Frequency
- Power Good Signal
- Remote On/Off
- Digital Interface through the Power Management Bus Protocol
- Ability to Sink and Source Current
- Cost Efficient Open Frame Design
- Over Temperature Protection
- Tunable Loop™ (a Registered Trademark of Lineage Power Systems) to Optimize Dynamic Output Voltage Response
- Flexible Output Voltage Sequencing EZ-SEQUENCE
- Output Over Current Protection (non-latching)
- Certificated to UL/CSA 62368-1
- Certificated to IEC/EN 62368-1
- Class II, Category 2, Non-Isolated DC/DC Converter (refer to IPC-9592B)

### Applications

- Distributed Power Architectures
- Intermediate Bus Voltage Applications
- Telecommunications Equipment
- Servers and Storage Applications
- Networking Equipment
- Industrial Equipment

## 1. MODEL SELECTION

MODEL NUMBER	OUTPUT VOLTAGE	INPUT VOLTAGE	MAX. OUTPUT CURRENT	MAX. OUTPUT POWER	TYPICAL EFFICIENCY
SLDN-06D1A0G	0.45 - 5.5 VDC	3 – 14.4 VDC	6 A	33 W	93.8%
SLDN-06D1A0R					
SLDN-06D1ALG					
SLDN-06D1ALR					

### PART NUMBER EXPLANATION

S	LDN	-	06	D	1A	x	y
Mounting Type	Series Code		Output Current	Input Voltage Range	Sequencing or not	Active Logic	Package Type
Surface mount	SLDN Series		6 A	3 – 14.4 V	With Sequencing	L – Active Low 0 – Active High	G – Tray Package R – Tape and Reel Package

## 2. ABSOLUTE MAXIMUM RATINGS

PARAMETER	DESCRIPTION	MIN	TYP	MAX	UNITS
Continuous Non-Operating Input Voltage		-0.3	-	15	V
Voltage on SEQ SYNC VS+		-	-	7	V
Voltage on CLK DATA SMBALERT Terminal		-	-	3.6	V
Ambient Temperature	See Thermal Considerations section	-40	-	85	°C
Storage Temperature		-55	-	125	°C
Altitude		-	-	4000	m

**NOTE:** Stresses in excess of the absolute maximum ratings can cause permanent damage to the device. These are absolute stress ratings only, functional operation of the device is not implied at these or any other conditions in excess of those given in the operations sections of the data sheet. Exposure to absolute maximum ratings for extended periods can adversely affect the device reliability.

### 3. INPUT SPECIFICATIONS

All specifications are typical at 25°C unless otherwise stated.

PARAMETER	DESCRIPTION	MIN	TYP	MAX	UNIT
Operating Input Voltage		3	-	14.4	V
Input Current (full load)	$V_{IN} = 3$ to 14.4 V	-	-	5	A
Input Current (no load)	$V_O = 0.6$ V	-	30	-	mA
	$V_O = 5$ V	-	90	-	mA
Input Stand-by Current	$V_{IN} = 12$ VDC, module disabled	-	6	-	mA
Input Reflected Ripple Current (pk-pk)	1. 5 Hz to 20 MHz, 1 $\mu$ H source impedance; $V_{IN} = 0$ to 14 V, $I_O = I_{O,max}$	-	11.2	-	mA
	2. See Test Configurations				
$I^2t$ Inrush Current Transient		-	-	1	A <sup>2</sup> s
Input Ripple Rejection (120 Hz)		-	-55	-	dB

**CAUTION: This converter is not internally fused. An input line fuse must be used in application.**

This power module can be used in a wide variety of applications, ranging from simple standalone operation to an integrated part of sophisticated power architecture. To preserve maximum flexibility, internal fusing is not included; however, to achieve maximum safety and system protection, always use an input line fuse. The safety agencies require a fast-acting fuse with a maximum rating of 6A. Based on the information provided in this data sheet on inrush energy and maximum dc input current, the same type of fuse with a lower rating can be used. Refer to the fuse manufacturer's data sheet for further information.

**Note:** Unless otherwise indicated, specifications apply over entire operating input voltage range, resistive load, and temperature conditions.

## 4. OUTPUT SPECIFICATIONS

All specifications are typical at nominal input, full load at 25°C unless otherwise stated.

PARAMETER	DESCRIPTION	MIN	TYP	MAX	UNIT		
Output Voltage Set Point	With 0.1% tolerance for external resistor used to set output voltage	-1.0	-	1.0	% $V_{o, set}$		
Output Voltage	Over entire operating input voltage range, resistive load, and temperature conditions until end of life	-0.3	-	0.3	% $V_{o, set}$		
Power Management Bus Adjustable Output Voltage Range		-25	0	25	% $V_{o, set}$		
Power Management Bus Output Voltage Adjustment Step Size		-	0.4	-	% $V_{o, set}$		
Adjustment Range	1. Some output voltages may not be possible depending on the input voltage – see Feature Descriptions Section 2. Selected by an external resistor	0.6	-	5.5	V		
Remote Sense Range		-	-	0.5	V		
Load Regulation	$V_o < 2.5V$	$I_o = I_{o, min}$ to $I_{o, max}$		10	mV		
	$V_o \geq 2.5V$			10	mV		
Line Regulation	$V_o < 2.5V$	$V_{IN} = V_{IN, min}$ to $V_{IN, max}$		0.4	% $V_{o, set}$		
	$V_o \geq 2.5V$			5	mV		
Temperature Regulation	$T_{ref} = T_{A, min}$ to $T_{A, max}$	-	-	0.4	% $V_{o, set}$		
Ripple and Noise (Pk-Pk)	5 Hz to 20 MHz BW, $V_{IN} = V_{IN, nom}$ and $I_o = I_{o, min}$ to $I_{o, max}$ Co = 0.1 $\mu F$ // 22 $\mu F$ ceramic capacitors)	-	50	100	mV		
Ripple and Noise (RMS)		-	20	38	mV		
Output Current Range	In either sink or source mode	0	-	6	A		
Output Current Limit Inception	Current limit does not operate in sink mode	-	200	-	% $I_{o, max}$		
Output Short-Circuit Current	$V_o \leq 250$ mV, Hiccup Mode	-	367	-	mArms		
Output Capacitance	ESR $\geq 1$ m $\Omega$	Without the Tunable Loop™		22	-	47	$\mu F$
	ESR $\geq 0.15$ m $\Omega$	With the Tunable Loop™		22	-	1000	$\mu F$
	ESR $\geq 10$ m $\Omega$	With the Tunable Loop™		22	-	3000	$\mu F$
Turn-On Delay Times ( $V_{IN} = V_{IN, nom}$ , $I_o = I_{o, max}$ , $V_o$ to within $\pm 1\%$ of steady state)	Case 1: On/Off input is enabled and then input power is applied (delay from instant at which $V_{IN} = V_{IN, min}$ until $V_o = 10\%$ of $V_{o, set}$ )	-	0.4	-	ms		
	Case 2: Input power is applied for at least one second and then the On/Off input is enabled (delay from instant at which On/Off is enabled until $V_o = 10\%$ of $V_{o, set}$ )	-	0.8	-	ms		
Output Voltage Rise Time	time for $V_o$ to rise from 10% of $V_{o, set}$ to 90% of $V_{o, set}$	-	2.2	-	ms		

- Notes:**
1. Some output voltages may not be possible depending on the input voltage.
  2. External capacitors may require using the new Tunable Loop™ feature to ensure that the module is stable as well as getting the best transient response (See the Tunable Loop™ section for details).
  3. Unless otherwise indicated, specifications apply over entire operating input voltage range, resistive load, and temperature conditions.

## 5. GENERAL SPECIFICATIONS

PARAMETER	DESCRIPTION	MIN	TYP	MAX	UNIT
Efficiency	$V_o = 0.6\text{ V}$	-	75.6	-	%
	$V_o = 1.2\text{ V}$	-	85.0	-	%
	$V_o = 1.8\text{ V}$	-	88.6	-	%
	$V_o = 2.5\text{ V}$	-	90.6	-	%
	$V_o = 3.3\text{ V}$	-	92.1	-	%
	$V_o = 5.0\text{ V}$	-	93.8	-	%
		$V_{in} = 12\text{ VDC}, T_A = 25\text{ }^\circ\text{C}$ $I_o = I_{o, \text{max}}, V_o = V_{o, \text{set}}$			
Switching Frequency		-	600	-	kHz
Synchronization Frequency Range		510	-	720	kHz
High-Level Input Voltage		2.0	-	-	V
Low-Level Input Voltage		-	-	0.4	V
Input Current, SYNC		-	-	100	nA
Minimum Pulse Width, SYNC		100	-	-	ns
Maximum SYNC Rise Time		100	-	-	ns
Over Temperature Protection		-	150	-	$^\circ\text{C}$
Power Management Bus Over Temperature Warning Threshold		-	130	-	$^\circ\text{C}$
Power Management Bus Adjustable Input Under Voltage Lockout Thresholds		2.5	-	14	V
Resolution of Adjustable Input Under Voltage Threshold		-	-	500	mV
Input Under-voltage Lockout	Turn-on Threshold	-	2.79	-	V
	Turn-off Threshold	-	2.58	-	V
	Hysteresis	-	0.2	-	V
Tracking Accuracy	Power-Up: 2 V/ms	-	-	100	mV
	Power-Down: 2 V/ms	-	-	100	mV
		$V_{in, \text{min}}$ to $V_{in, \text{max}}; I_o, \text{min}$ to $I_o, \text{max}; V_{\text{seq}} < V_o$			
PGOOD (Power Good)	Over-voltage Threshold for PGOOD ON	-	108	-	% $V_{o, \text{set}}$
	Over-voltage Threshold for PGOOD OFF	-	110	-	% $V_{o, \text{set}}$
	Under-voltage Threshold for PGOOD ON	-	92	-	% $V_{o, \text{set}}$
	Under-voltage Threshold for PGOOD OFF	-	90	-	% $V_{o, \text{set}}$
	Pulldown Resistance of PGOOD pin	-	-	50	$\Omega$
	Sink Current Capability into PGOOD pin	-	-	5	mA
Weight		-	1.65	-	g
MTBF	Calculated MTBF ( $I_o = 0.8 I_{o, \text{max}}, T_A = 40^\circ\text{C}$ ) Telecordia Issue 2 Method 1 Case 3	-	18,595,797	-	hours
Dimensions (L x W x H)		0.48 x 0.48 x 0.29			inch
		12.19 x 12.19 x 7.25			mm

**Note:** Unless otherwise indicated, specifications apply over entire operating input voltage range, resistive load, and temperature conditions.

## 6. DIGITAL INTERFACE SPECIFICATIONS

PARAMETER	DESCRIPTION	MIN	TYP	MAX	UNIT
<i>Power Management Bus Signal Interface Characteristics</i>					
Input High Voltage (CLK, DATA)		2.1	-	3.6	V
Input Low Voltage (CLK, DATA)		-	-	0.8	V
Input High Level Current (CLK, DATA)		-10	-	10	μA
Input Low Level Current (CLK, DATA)		-10	-	10	μA
Output Low Voltage (CLK, DATA, SMBALERT#)	$I_{out} = 2 \text{ mA}$	-	-	0.4	V
Output High Level Open Drain Leakage Current (DATA, SMBALERT#)	$V_{out} = 3.6 \text{ V}$	0	-	10	μA
Pin Capacitance		-	0.7	-	pF
Power Management Bus Operating Frequency Range		10	-	400	kHz
Data Setup Time		250	-	-	ns
Data Hold Time	Receive Mode	0	-	-	ns
	Transmit Mode	300	-	-	ns
<i>Measurement System Characteristics</i>					
Read Delay Time		153	192	231	μs
Output Current Measurement Range		0	-	18	A
Output Current Measurement Resolution		62.5	-	-	mA
Output Current Measurement Gain Accuracy		-	-	±5	%
Output Current Measurement Offset		-	-	0.1	A
$V_{OUT}$ Measurement Range		0	-	5.5	V
$V_{OUT}$ Measurement Resolution		-	15.625	-	mA
$V_{OUT}$ Measurement Gain Accuracy		-15	-	15	%
$V_{OUT}$ Measurement Offset		-3	-	3	%
$V_{IN}$ Measurement Range		3	-	14.4	V
$V_{IN}$ Measurement Resolution		-	32.5	-	mV
$V_{IN}$ Measurement Gain Accuracy		-15	-	15	%
$V_{IN}$ Measurement Offset		-5.5	-	1.4	LSB

7. EFFICIENCY DATA

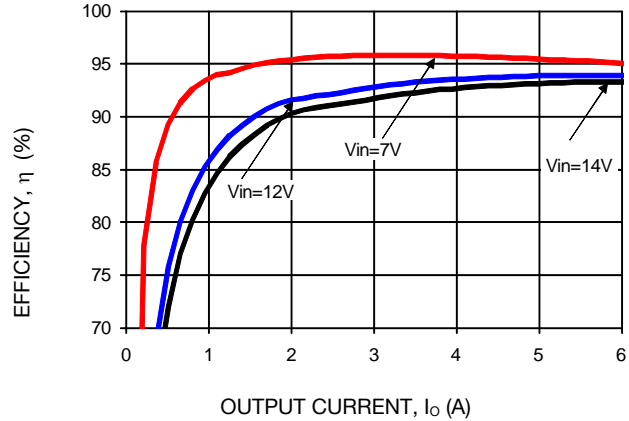
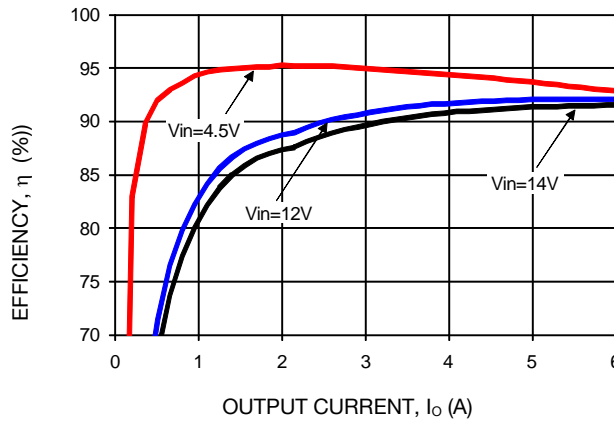
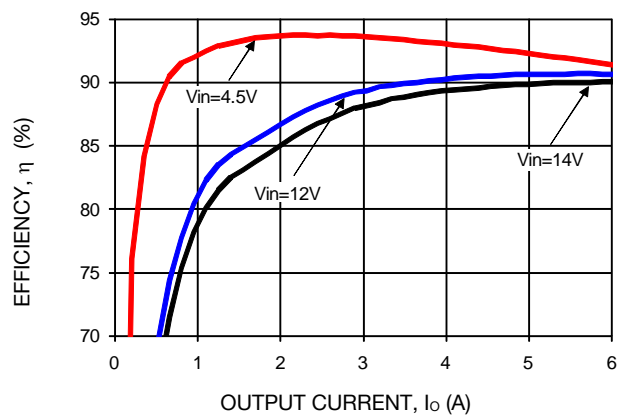
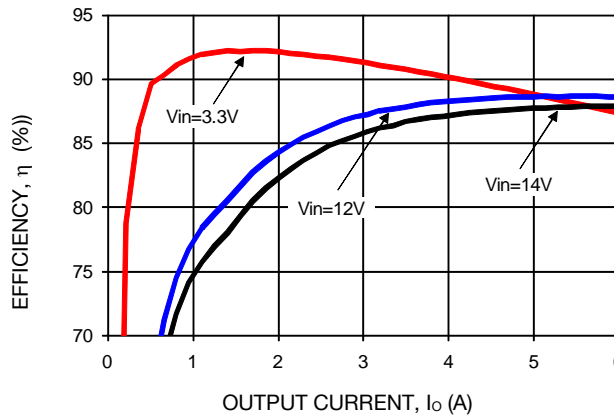
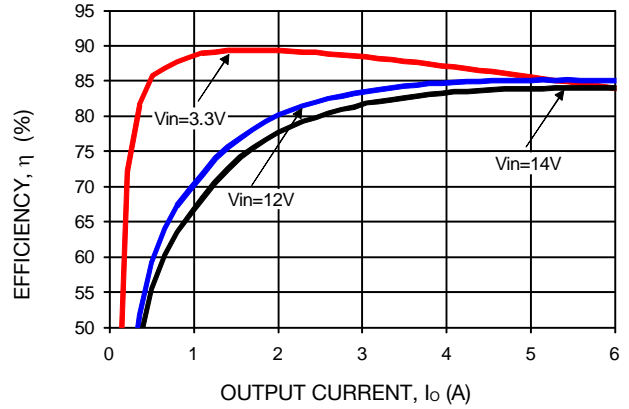
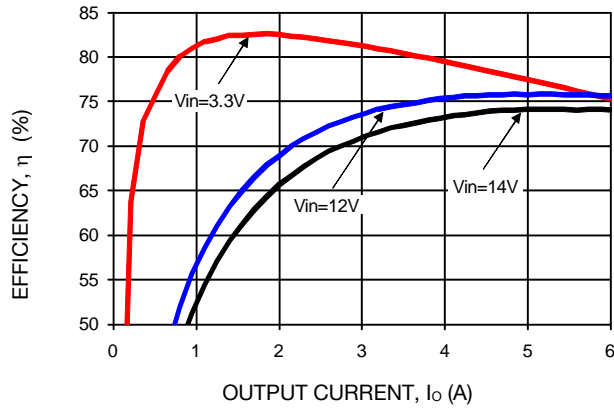

<b>Asia-Pacific</b> +86 755 298 85888	<b>Europe, Middle East</b> +353 61 49 8941	<b>North America</b> +1 866 513 2839
--	---	---

8. THERMAL DERATING CURVE

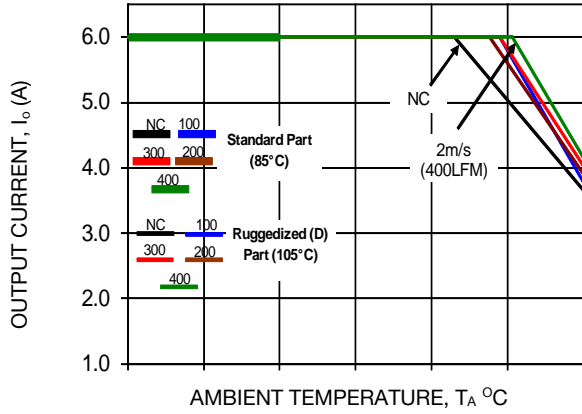

Figure 7.  $V_o = 0.6 V$

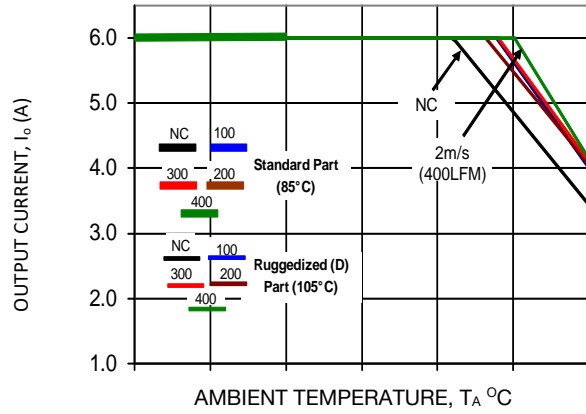

Figure 8.  $V_o = 1.2 V$

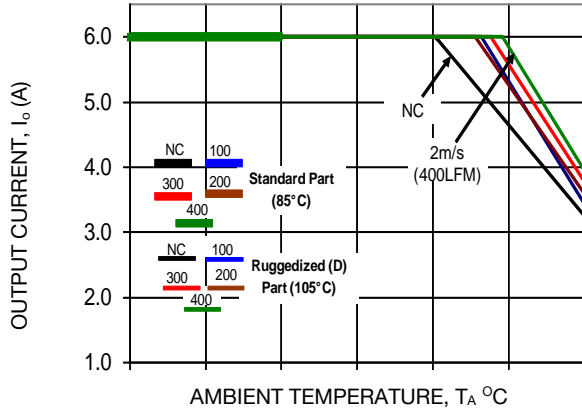

Figure 9.  $V_o = 1.8 V$

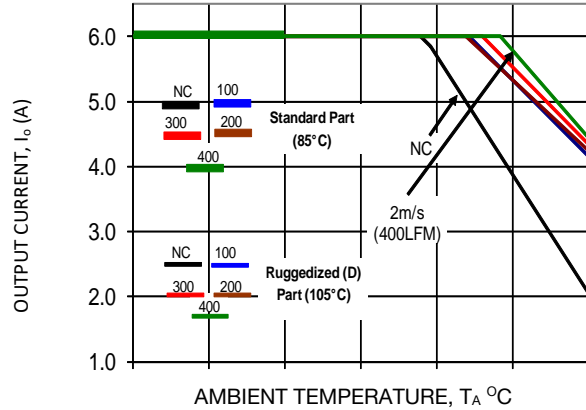

Figure 10.  $V_o = 2.5 V$

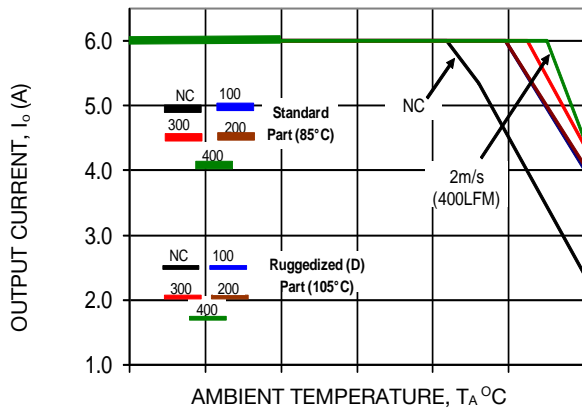

Figure 11.  $V_o = 3.3 V$

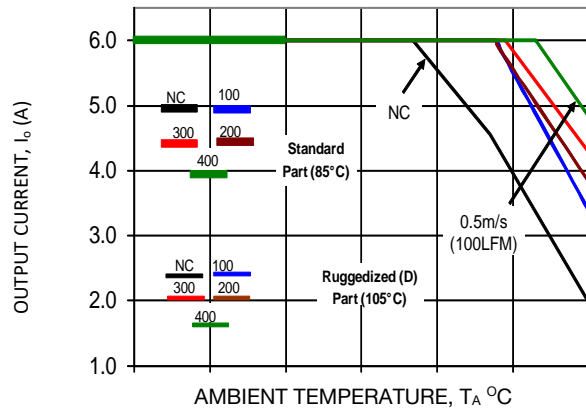

Figure 12.  $V_o = 5.0 V$



## 9. RIPPLE AND NOISE WAVEFORM

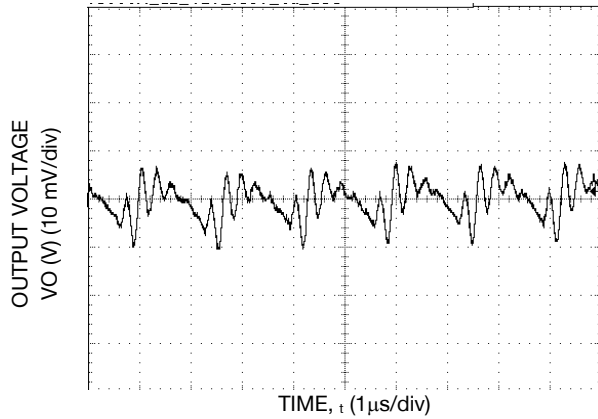

Figure 13.  $V_o = 0.6\text{ V}$ ,  $I_o = I_o, \text{max}$

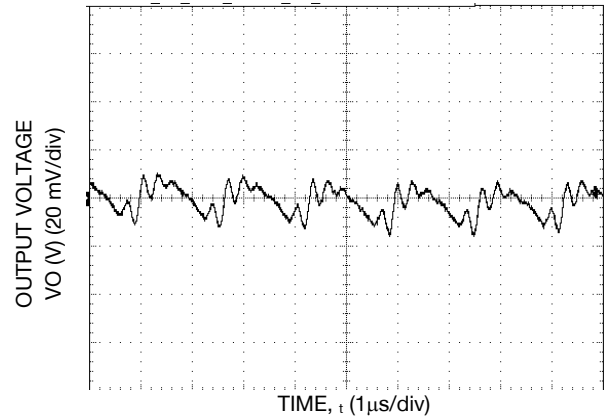

Figure 14.  $V_o = 1.2\text{ V}$ ,  $I_o = I_o, \text{max}$

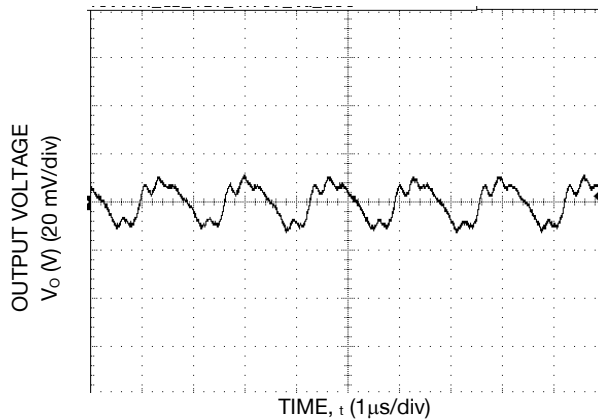

Figure 15.  $V_o = 1.8\text{ V}$ ,  $I_o = I_o, \text{max}$

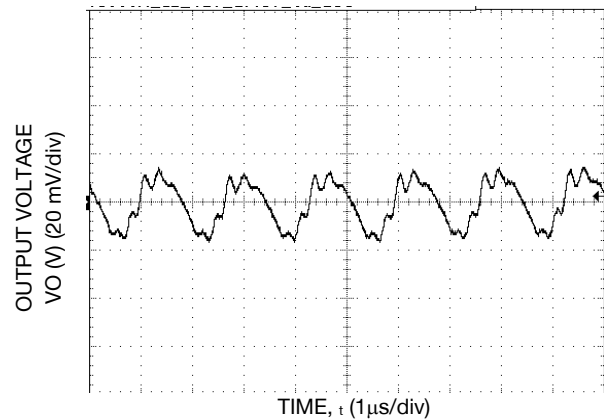

Figure 16.  $V_o = 2.5\text{ V}$ ,  $I_o = I_o, \text{max}$

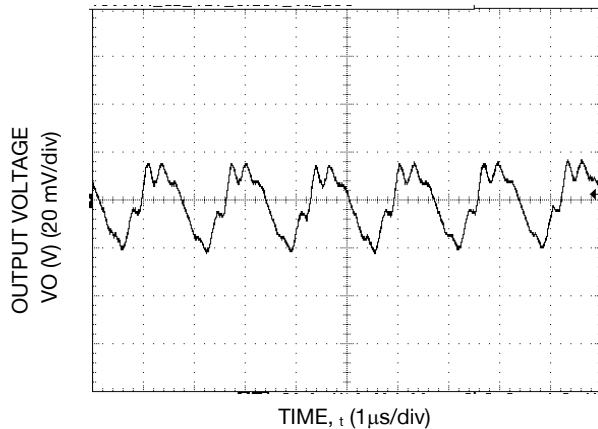

Figure 17.  $V_o = 3.3\text{ V}$ ,  $I_o = I_o, \text{max}$

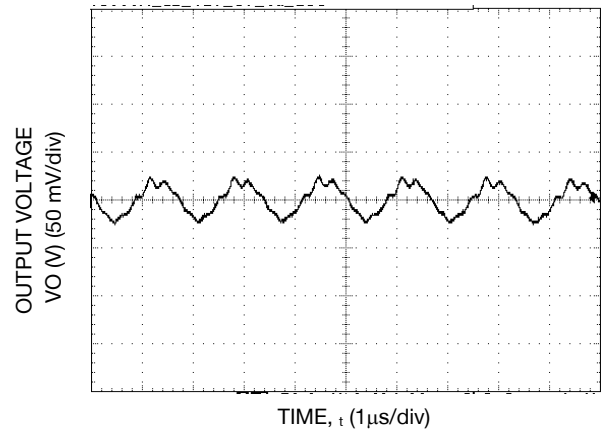

Figure 18.  $V_o = 5.0\text{ V}$ ,  $I_o = I_o, \text{max}$

**Note:**  $C_O = 22\ \mu\text{F}$  ceramic,  $V_{IN} = 12\text{ V}$ .



Asia-Pacific  
+86 755 298 85888

Europe, Middle East  
+353 61 49 8941

North America  
+1 866 513 2839

## 10. TRANSIENT RESPONSE WAVEFORMS

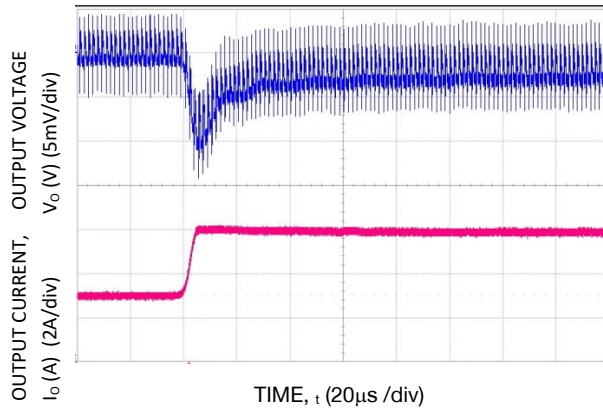

Figure 19. Transient Response to Dynamic Load Change from 50% to 100% at 12 Vin,  $C_{out} = 1 \times 47 \mu\text{F} + 4 \times 330 \mu\text{F}$ ,  $C_{Tune} = 33 \text{ nF}$ ,  $R_{Tune} = 178 \Omega$ .  $V_o = 0.6 \text{ V}$

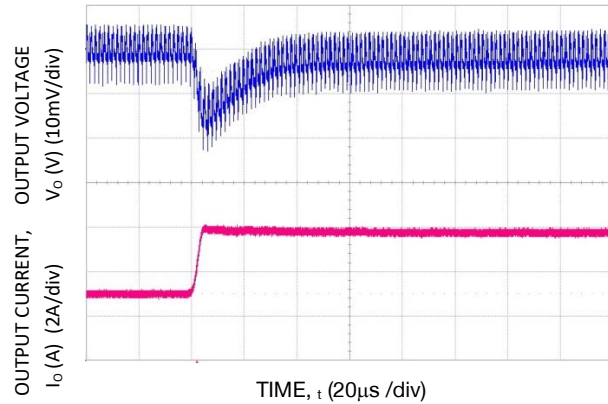

Figure 20. Transient Response to Dynamic Load Change from 50% to 100% at 12 Vin,  $C_{out} = 1 \times 47 \mu\text{F} + 2 \times 330 \mu\text{F}$ ,  $C_{Tune} = 12 \text{ nF}$ ,  $R_{Tune} = 178 \Omega$ .  $V_o = 1.2 \text{ V}$

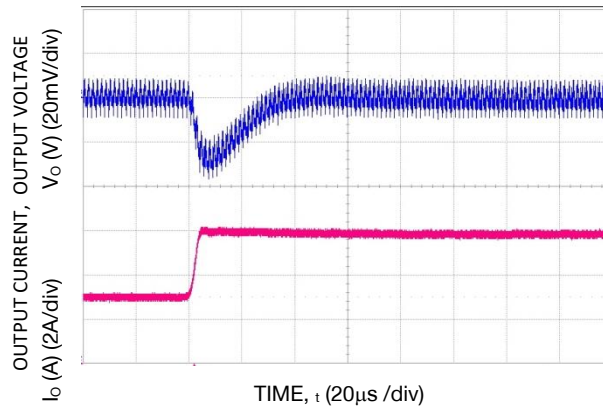

Figure 21. Transient Response to Dynamic Load Change from 50% to 100% at 12 Vin,  $C_{out} = 1 \times 47 \mu\text{F} + 1 \times 330 \mu\text{F}$ ,  $C_{Tune} = 4700 \text{ pF}$ ,  $R_{Tune} = 178 \Omega$ .  $V_o = 1.8 \text{ V}$

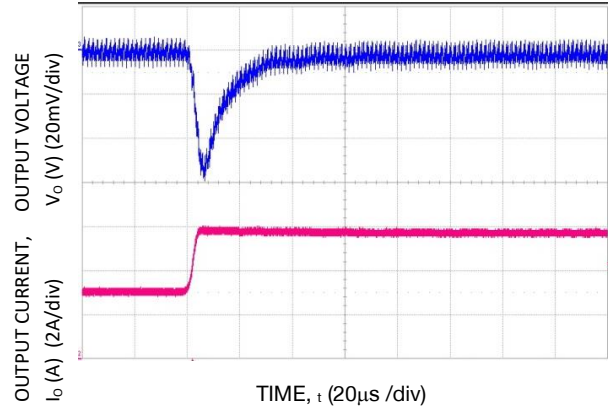

Figure 22. Transient Response to Dynamic Load Change from 50% to 100% at 12 Vin,  $C_{out} = 3 \times 47 \mu\text{F}$ ,  $C_{Tune} = 3300 \text{ pF}$ ,  $R_{Tune} = 178 \Omega$ .  $V_o = 2.5 \text{ V}$

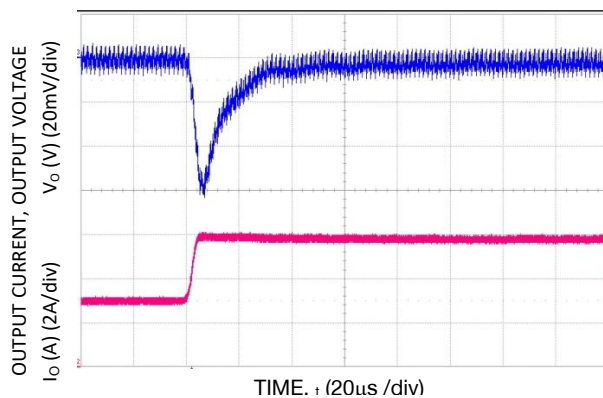

Figure 23. Transient Response to Dynamic Load Change from 50% to 100% at 12 Vin,  $C_{out} = 3 \times 47 \mu\text{F}$ ,  $C_{Tune} = 3300 \text{ pF}$ ,  $R_{Tune} = 178 \Omega$ .  $V_o = 3.3 \text{ V}$

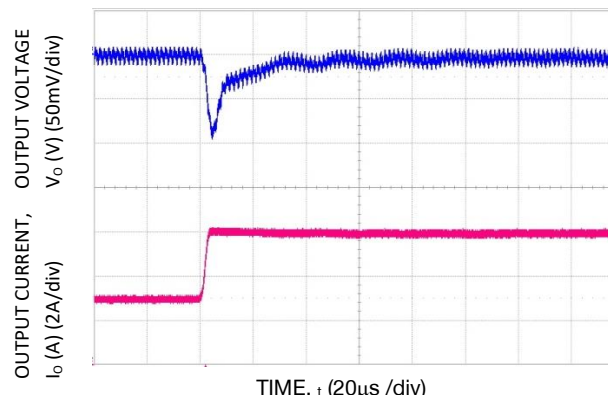

Figure 24. Transient Response to Dynamic Load Change from 50% to 100% at 12 Vin,  $C_{out} = 2 \times 47 \mu\text{F}$ ,  $C_{Tune} = 2200 \text{ pF}$ ,  $R_{Tune} = 261 \Omega$ .  $V_o = 5.0 \text{ V}$

11. STARTUP & TIME

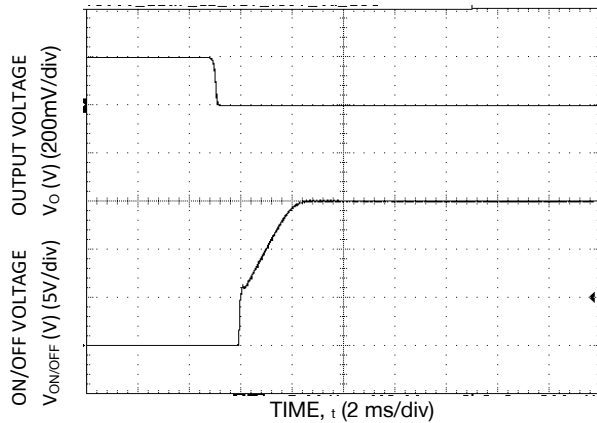

Figure 25. Start-up Using On/Off Voltage ( $I_o = I_{o, max}$ ),  $V_o = 0.6 V$

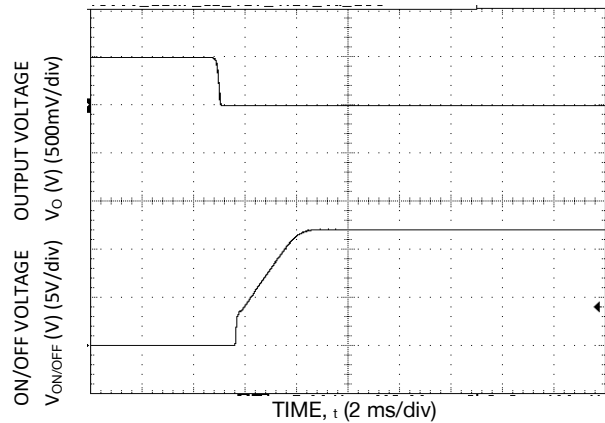

Figure 26. Start-up Using On/Off Voltage ( $I_o = I_{o, max}$ ),  $V_o = 1.2 V$

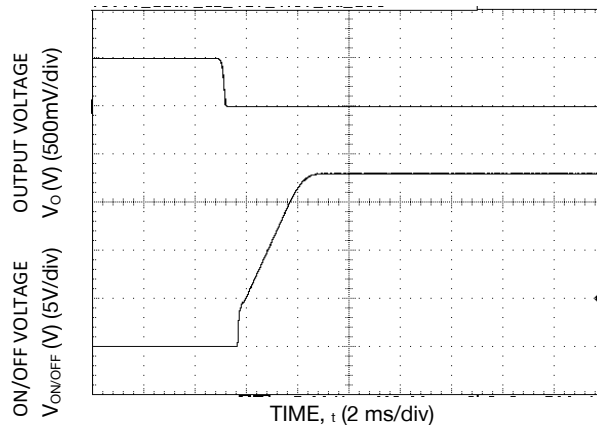

Figure 27. Start-up Using On/Off Voltage ( $I_o = I_{o, max}$ ),  $V_o = 1.8 V$

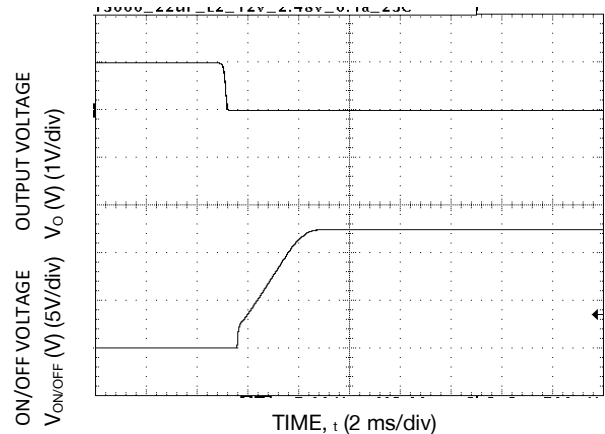

Figure 28. Start-up Using On/Off Voltage ( $I_o = I_{o, max}$ ),  $V_o = 2.5 V$

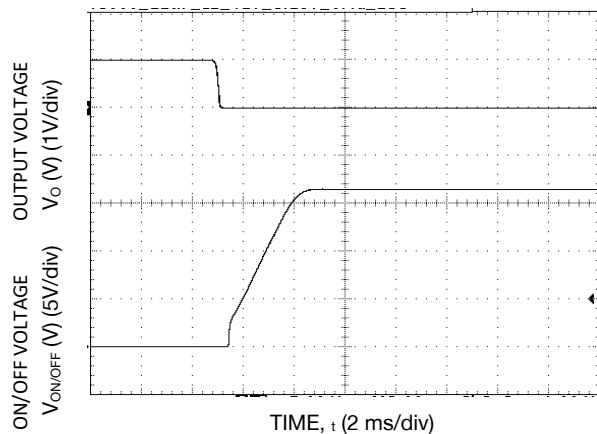

Figure 29. Start-up Using On/Off Voltage ( $I_o = I_{o, max}$ ),  $V_o = 3.3 V$

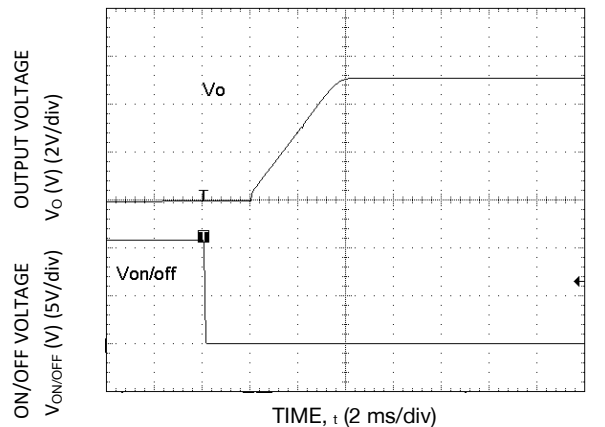

Figure 30. Start-up Using On/Off Voltage ( $I_o = I_{o, max}$ ),  $V_o = 5.0 V$



Asia-Pacific +86 755 298 85888	Europe, Middle East +353 61 49 8941	North America +1 866 513 2839
-----------------------------------	--	----------------------------------

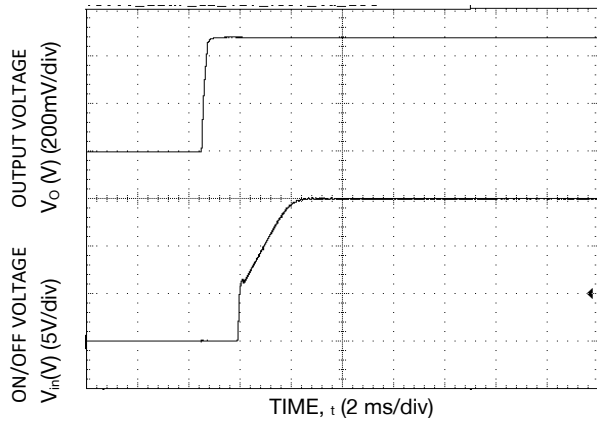

Figure 31. Start-up Using Input Voltage ( $V_{IN} = 12\text{ V}$ ,  $I_o = I_{o, max}$ ,  $V_o = 0.6\text{ V}$ )

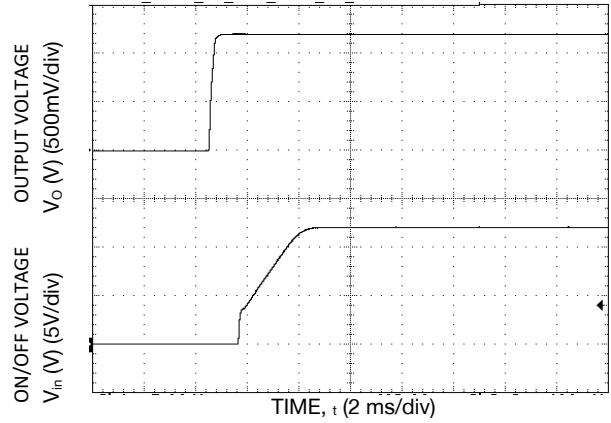

Figure 32. Start-up Using Input Voltage ( $V_{IN} = 12\text{ V}$ ,  $I_o = I_{o, max}$ ,  $V_o = 1.2\text{ V}$ )

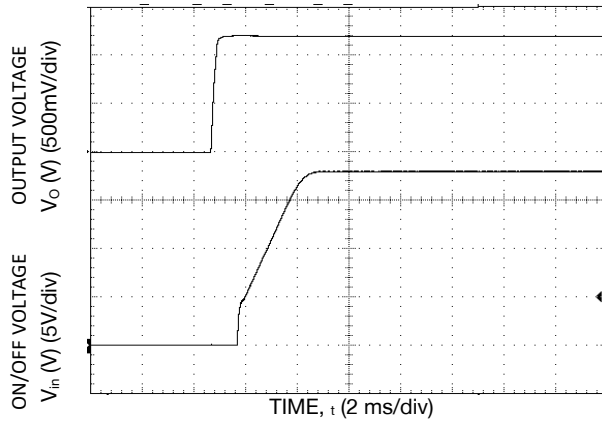

Figure 33. Start-up Using Input Voltage ( $V_{IN} = 12\text{ V}$ ,  $I_o = I_{o, max}$ ,  $V_o = 1.8\text{ V}$ )

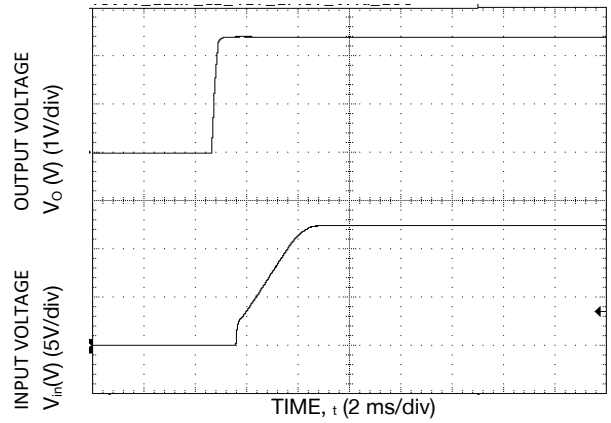

Figure 34. Start-up Using Input Voltage ( $V_{IN} = 12\text{ V}$ ,  $I_o = I_{o, max}$ ,  $V_o = 2.5\text{ V}$ )

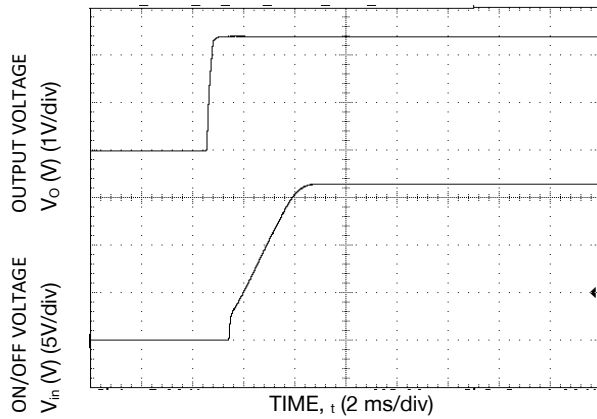

Figure 35. Start-up Using Input Voltage ( $V_{IN} = 12\text{ V}$ ,  $I_o = I_{o, max}$ ,  $V_o = 3.3\text{ V}$ )

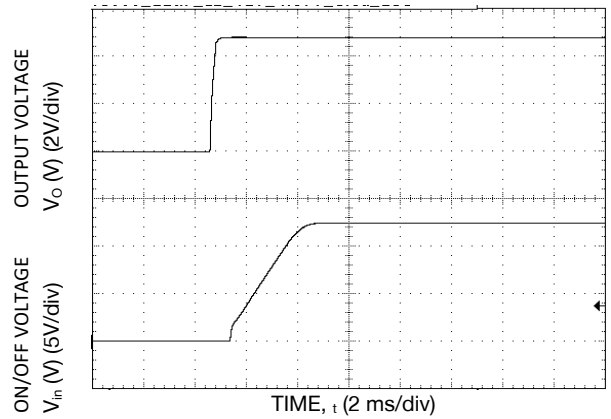

Figure 36. Start-up Using Input Voltage ( $V_{IN} = 12\text{ V}$ ,  $I_o = I_{o, max}$ ,  $V_o = 5.0\text{ V}$ )

## 12. INPUT FILTERING

The SLDN-06D1Ax module should be connected to a low ac-impedance source. A highly inductive source can affect the stability of the module. An input capacitance must be placed directly adjacent to the input pin of the module, to minimize input ripple voltage and ensure module stability.

To minimize input voltage ripple, ceramic capacitors are recommended at the input of the module. Figure 37 shows the input ripple for various output voltages at 6 A of load current with 1x22  $\mu$ F or 2x22  $\mu$ F ceramic capacitors and an input of 12 V.

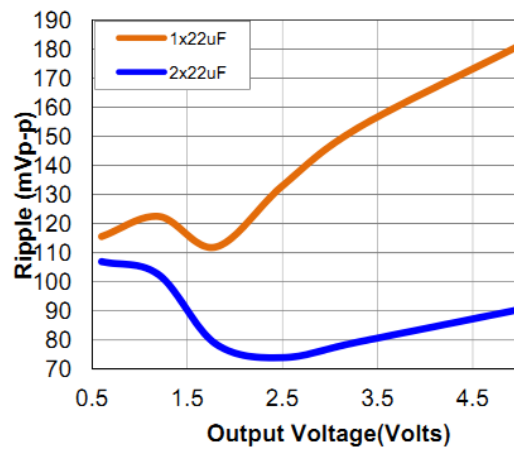

Figure 37.

**Note:** Input ripple voltage for various output voltages with 1x22  $\mu$ F or 2x22  $\mu$ F ceramic capacitors at the input (6 A load). Input voltage is 12 V.

### 13. OUTPUT FILTERING

These modules are designed for low output ripple voltage and will meet the maximum output ripple specification with 0.1  $\mu\text{F}$  ceramic and 22  $\mu\text{F}$  ceramic capacitors at the output of the module. However, additional output filtering may be required by the system designer for a number of reasons. First, there may be a need to further reduce the output ripple and noise of the module. Second, the dynamic response characteristics may need to be customized to a particular load step change.

To reduce the output ripple and improve the dynamic response to a step load change, additional capacitance at the output can be used. Low ESR polymer and ceramic capacitors are recommended to improve the dynamic response of the module. Figure 38 provides output ripple information for different external capacitance values at various  $V_o$  and a full load current of 6 A. For stable operation of the module, limit the capacitance to less than the maximum output capacitance as specified in the electrical specification table. Optimal performance of the module can be achieved by using the Tunable Loop™ feature described later in this data sheet.

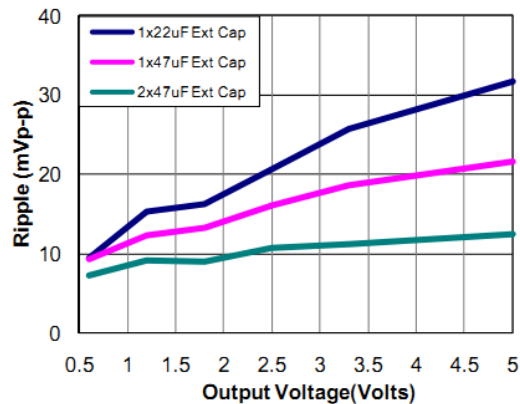

Figure 38.

**Note:** Output ripple voltage for various output voltages with external 1x22  $\mu\text{F}$ , 1x47  $\mu\text{F}$ , or 2x47  $\mu\text{F}$  ceramic capacitors at the output (6 A load). Input voltage is 12 V.

### 14. SAFETY CONSIDERATIONS

For safety agency approval the power module must be installed in compliance with the spacing and separation requirements of the end-use safety agency standards, i.e., UL/CSA 62368-1, IEC/EN 62368-1.

For the converter output to be considered meeting the requirements of electrical energy source class 1 (ES1), the input must meet ES1 requirements.

The input to these units is to be provided with a fuse with a maximum rating of 10 A in the positive input lead.

15. REMOTE ON/OFF

PARAMETER	DESCRIPTION	MIN	TYP	MAX	UNIT	
Signal Low (Unit On)	Active Low	The remote on/off pin open, Unit on	-0.2	-	0.6	V
Signal High (Unit Off)			2.0	-	Vin, max	V
Signal Low (Unit Off)	Active High	The remote on/off pin open, Unit on	-0.2	-	0.6	V
Signal High (Unit On)			2.0	-	Vin, max	V

The SLDN-06D1Ax module can be turned ON and OFF either by using the ON/OFF pin (Analog interface) or through the Power Management Bus interface (Digital). The module can be configured in a number of ways through the Power Management Bus interface to react to the two ON/OFF inputs:

- Module ON/OFF can be controlled only through the analog interface (digital interface ON/OFF commands are ignored).
- Module ON/OFF can be controlled only through the Power Management Bus interface (analog interface is ignored).
- Module ON/OFF can be controlled by either the analog or digital interface.

The default state of the module (as shipped from the factory) is to be controlled by the analog interface only. If the digital interface is to be enabled, or the module is to be controlled only through the digital interface, this change must be made through the Power Management Bus. These changes can be made and written to non-volatile memory on the module so that it is remembered for subsequent use.

16. ANALOG ON/OFF

The SLDN-06D1Ax modules feature an On/Off pin for remote On/Off operation. Two On/Off logic options are available. In the Positive Logic On/Off option, (device code suffix “0” – see Ordering Information), the module turns ON during a logic High on the On/Off pin and turns OFF during a logic Low. With the Negative Logic On/Off option, (device code suffix “L” – see Ordering Information), the module turns OFF during logic High and ON during logic Low. The On/Off signal should be always referenced to ground. For either On/Off logic option, leaving the On/Off pin disconnected will turn the module ON when input voltage is present. For positive logic modules, the circuit configuration for using the On/Off pin is shown in Figure 39. When the external transistor Q2 is in the OFF state, the internal transistor Q1 is turned ON, and the internal PWM #Enable signal is pulled low causing the module to be ON. When transistor Q2 is turned ON, the On/Off pin is pulled low and the module is OFF. A suggested value for Rpullup is 20 kΩ .

For negative logic On/Off modules, the circuit configuration is shown in Fig. 40. The On/Off pin should be pulled high with an external pull-up resistor (suggested value for the 3 V to 14 V input range is 20 kΩ). When transistor Q2 is in the OFF state, the On/Off pin is pulled high, transistor Q1 is turned ON and the module is OFF. To turn the module ON, Q2 is turned ON pulling the On/Off pin low, turning transistor Q1 OFF resulting in the PWM Enable pin going high.

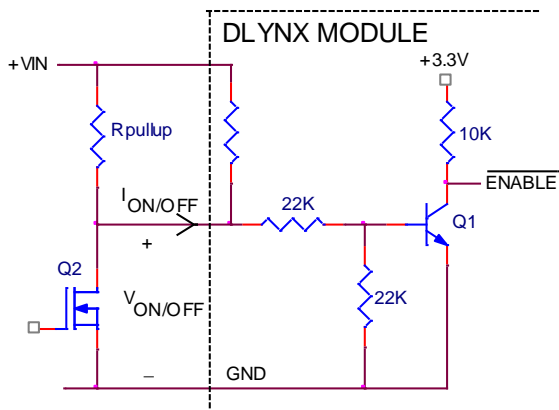

Figure 39. Circuit configuration for using positive On/Off logic

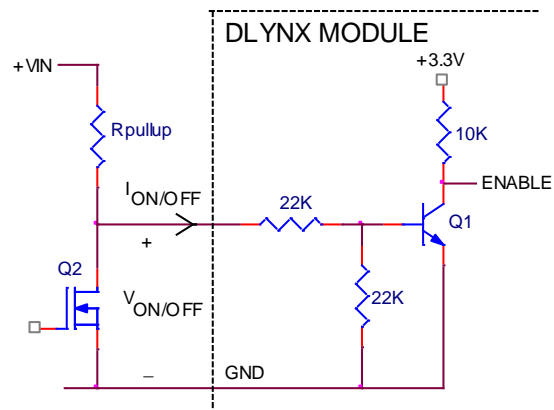

Figure 40. Circuit configuration for using negative On/Off logic



Asia-Pacific +86 755 298 85888 Europe, Middle East +353 61 49 8941 North America +1 866 513 2839

## 17. DIGITAL ON/OFF

Please see the Digital Feature Descriptions section.

## 18. MONOTONIC START-UP AND SHUTDOWN

The SLDN-06D1Ax module has monotonic start-up and shutdown behavior for any combination of rated input voltage, output current and operating temperature range.

## 19. STARTUP INTO PRE-BIASED OUTPUT

The SLDN-06D1Ax module can start into a pre-biased output as long as the pre-bias voltage is 0.5 V less than the set output voltage.

## 20. OUTPUT VOLTAGE PROGRAMMING

The output voltage of the module is programmable to any voltage from 0.6 VDC to 5.5 VDC by connecting a resistor between the Trim and SIG\_GND pins of the module. Certain restrictions apply on the output voltage set point depending on the input voltage. These are shown in the Output Voltage vs. Input Voltage Set Point Area plot in Fig. 41. The Upper Limit curve shows that for output voltages lower than 1 V, the input voltage must be lower than the maximum of 14.4 V. The Lower Limit curve shows that for output voltages higher than 0.6 V, the input voltage needs to be larger than the minimum of 3 V.

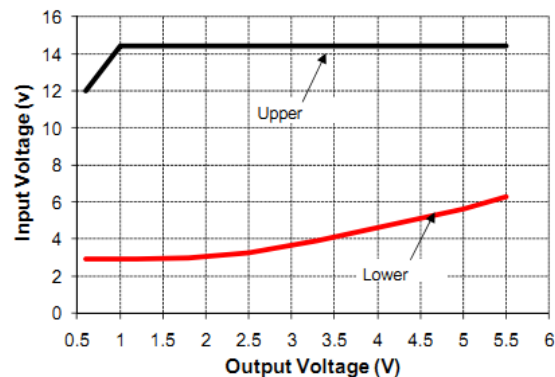

Figure 41.

Output Voltage vs. Input Voltage Set Point Area plot showing limits where the output voltage can be set for different input voltages.



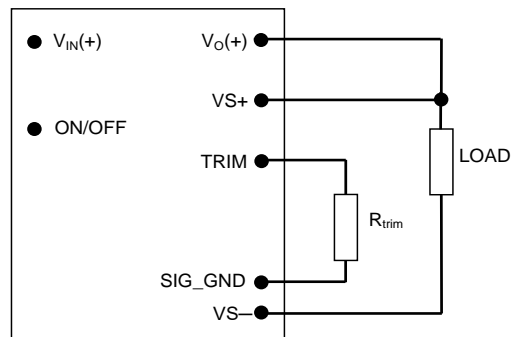

Figure 42.

**CAUTION:** Do not connect SIG\_GND to GND elsewhere in the layout Circuit configuration for programming output voltage using an external resistor.

## 21. OUTPUT TRIM EQUATIONS

Without an external resistor between Trim and SIG\_GND pins, the output of the module will be 0.6 VDC. To calculate the value of the trim resistor, Rtrim for a desired output voltage, should be as per the following equation:

$$R_{trim} = \left[ \frac{12}{(V_o - 0.6)} \right] k\Omega$$

Rtrim is the external resistor in KΩ

Vo is the desired output voltage.

Table 1 provides Rtrim values required for some common output voltages.

VO, SET (V)	Rtrim (kΩ)
0.6	Open
0.9	40
1.0	30
1.2	20
1.5	13.33
1.8	10
2.5	6.316
3.3	4.444
5.0	2.727

Table 1.

By using a ±0.5% tolerance trim resistor with a TC of ±100 ppm, a set point tolerance of ±1.5% can be achieved as specified in the electrical specification.

## 22. DIGITAL OUTPUT VOLTAGE ADJUSTMENT

Please see the Digital Feature Descriptions section.

## 23. REMOTE SENSE

The SLDN-06D1Ax power module has a Remote Sense feature to minimize the effects of distribution losses by regulating the voltage between the sense pins (VS+ and VS-). The voltage drops between the sense pins and the VOUT and GND pins of the module should not exceed 0.5 V.

## 24. VOLTAGE MARGINING

Output voltage margining can be implemented in the module by connecting a resistor, Rmargin-up, from the Trim pin to the ground pin for margining-up the output voltage and by connecting a resistor, Rmargin-down, from the Trim pin to the output pin for margining-down. Figure 43 shows the circuit configuration for output voltage margining. Please consult your local Bel Power technical representative for additional details.

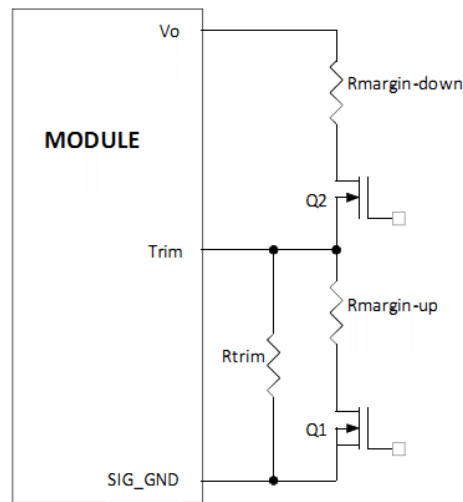

Figure 43.  
Circuit Configuration for margining Output voltage

## 25. DIGITAL OUTPUT VOLTAGE MARGINING

Please see the Digital Feature Descriptions section.

## 26. OUTPUT VOLTAGE SEQUENCING

The SLDN-06D1Ax module includes a sequencing feature, EZ-SEQUENCE that enables users to implement various types of output voltage sequencing in their applications. This is accomplished via an additional sequencing pin. When not using the sequencing feature, leave it unconnected.

The voltage applied to the SEQ pin should be scaled down by the same ratio as used to scale the output voltage down to the reference voltage of the module. This is accomplished by an external resistive divider connected across the sequencing voltage before it is fed to the SEQ pin as shown in Fig. 44. In addition, a small capacitor (suggested value 100 pF) should be connected across the lower resistor R1.

For SLDN-06D1x modules, the minimum recommended delay between the ON/OFF signal and the sequencing signal is 10ms to ensure that the module output is ramped up according to the sequencing signal. This ensures that the module soft-start routine is completed before the sequencing signal is allowed to ramp up.

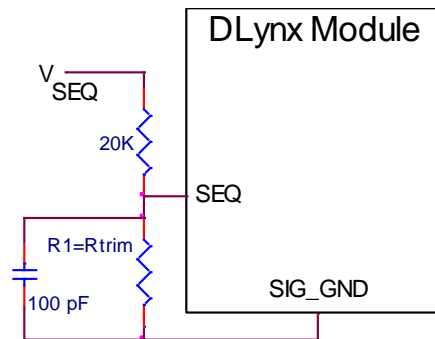

Figure 44.  
Circuit showing connection of the sequencing signal to the SEQ pin

When the scaled down sequencing voltage is applied to the SEQ pin, the output voltage tracks this voltage until the output reaches the set-point voltage. The final value of the sequencing voltage must be set higher than the set-point voltage of the module. The output voltage follows the sequencing voltage on a one-to-one basis. By connecting multiple modules together, multiple modules can track their output voltages to the voltage applied on the SEQ pin.

To initiate simultaneous shutdown of the modules, the SEQ pin voltage is lowered in a controlled manner. The output voltage of the modules tracks the voltages below their set-point voltages on a one-to-one basis. A valid input voltage must be maintained until the tracking and output voltages reach ground potential.

Note that in all digital Bel series of modules, the Power Management Bus Output Undervoltage Fault will be tripped when sequencing is employed. This will be detected using the STATUS\_WORD and STATUS\_VOUT Power Management Bus commands. In addition, the SMBALERT# signal will be asserted low as occurs for all faults and warnings. To avoid the module shutting down due to the Output Undervoltage Fault, the module must be set to continue operation without interruption as the response to this fault (see the description of the Power Management Bus command VOUT\_UV\_FAULT\_RESPONSE for additional information).

## 27. OVER CURRENT PROTECTION

To provide protection in a fault (output overload) condition, the unit is equipped with internal current-limiting circuitry and can endure current limiting continuously. At the point of current-limit inception, the unit enters hiccup mode. The unit operates normally once the output current is brought back into its specified range.

## 28. DIGITAL ADJUSTABLE OVERCURRENT WARNING

Please see the Digital Feature Descriptions section.

## 29. OVER TEMPERATURE PROTECTION

To provide protection in a fault condition, the unit is equipped with a thermal shutdown circuit. The unit will shut down if the overtemperature threshold of 150°C (type) is exceeded at the thermal reference point Tref. Once the unit goes into thermal shutdown it will then wait to cool before attempting to restart.

## 30. DIGITAL TEMPERATURE STATUS VIA POWER MANAGEMENT BUS

Please see the Digital Feature Descriptions section.

## 31. DIGITAL ADJUSTABLE OUTPUT OVER AND UNDER VOLTAGE PROTECTION

Please see the Digital Feature Descriptions section.

## 32. INPUT UNDERVOLTAGE LOCKOUT

At input voltages below the input undervoltage lockout limit, the module operation is disabled. The module will begin to operate at an input voltage above the undervoltage lockout turn-on threshold.

## 33. DIGITAL ADJUSTABLE INPUT UNDERVOLTAGE LOCKOUT

Please see the Digital Feature Descriptions section.

## 34. DIGITAL ADJUSTABLE POWER GOOD THRESHOLDS

Please see the Digital Feature Descriptions section.

### 35. SYNCHRONIZATION

The SLDN-06D1Ax module switching frequency can be synchronized to a signal with an external frequency within a specified range. Synchronization can be done by using the external signal applied to the SYNC pin of the module as shown in Fig. 45, with the converter being synchronized by the rising edge of the external signal. The Electrical Specifications table specifies the requirements of the external SYNC signal. If the SYNC pin is not used, the module should free run at the default switching frequency. If synchronization is not being used, connect the SYNC pin to GND.

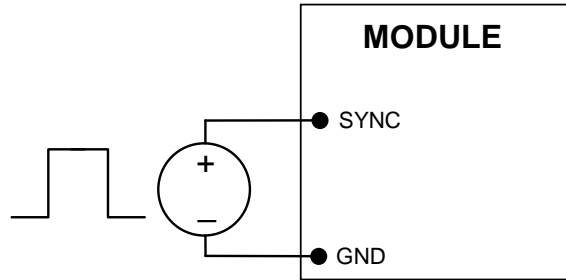

Figure 45.  
External source connections to synchronize switching frequency of the module.

### 36. MEASURING OUTPUT CURRENT, OUTPUT VOLTAGE AND INPUT VOLTAGE

Please see the Digital Feature Descriptions section.

### 37. DUAL LAYOUT

Identical dimensions and pin layout of Analog and Digital modules permit migration from one to the other without needing to change the layout. To support this, 2 separate Trim Resistor locations have to be provided in the layout. As shown in Fig. 46, for the digital modules, the resistor is connected between the TRIM pad and SGND and in the case of the analog module it is connected between TRIM and GND.

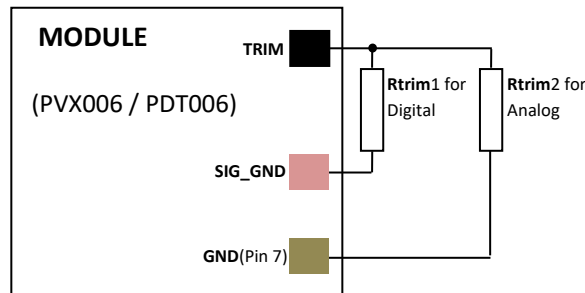

Figure 46.

**Caution:** For digital modules, do not connect SIG\_GND to GND elsewhere in the layout to support either Analog or Digital on the same pad.

### 38. TUNABLE LOOP™

The SLDN-06D1Ax has a feature that optimizes transient response of the module called Tunable Loop™.

External capacitors are usually added to the output of the module for two reasons: to reduce output ripple and noise (see Figure 38) and to reduce output voltage deviations from the steady-state value in the presence of dynamic load current changes. Adding external capacitance however affects the voltage control loop of the module, typically causing the loop to slow down with sluggish response. Larger values of external capacitance could also cause the module to become unstable.

The Tunable Loop™ allows the user to externally adjust the voltage control loop to match the filter network connected to the output of the module. The Tunable Loop™ is implemented by connecting a series R-C between the VS+ and TRIM pins of the module, as shown in Fig. 47. This R-C allows the user to externally adjust the voltage loop feedback compensation of the module.

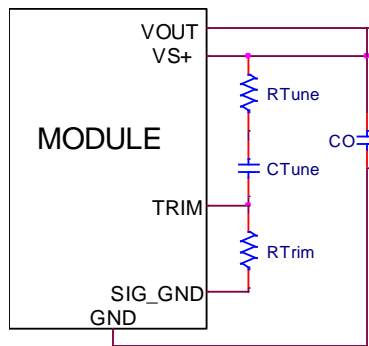

Figure 47.

Circuit diagram showing connection of  $R_{TUNE}$  and  $C_{TUNE}$  to tune the control loop of the module

Recommended values of  $R_{TUNE}$  and  $C_{TUNE}$  for different output capacitor combinations are given in Tables 2 and 3. Table 3 shows the recommended values of  $R_{TUNE}$  and  $C_{TUNE}$  for different values of ceramic output capacitors up to 1000  $\mu\text{F}$  that might be needed for an application to meet output ripple and noise requirements. Selecting  $R_{TUNE}$  and  $C_{TUNE}$  according to Table 3 will ensure stable operation of the module.

In applications with tight output voltage limits in the presence of dynamic current loading, additional output capacitance will be required. Table 3 lists recommended values of  $R_{TUNE}$  and  $C_{TUNE}$  in order to meet 2% output voltage deviation limits for some common output voltages in the presence of a 6 A to 6 A step change (50% of full load), with an input voltage of 12 V.

Please contact your Bel Power technical representative to obtain more details of this feature as well as for guidelines on how to select the right value of external R-C to tune the module for best transient performance and stable operation for other output capacitance values.

$C_o$	1x47 $\mu\text{F}$	2x47 $\mu\text{F}$	4x47 $\mu\text{F}$	6x47 $\mu\text{F}$	10x47 $\mu\text{F}$
$R_{TUNE}$	330 $\Omega$	270 $\Omega$	220 $\Omega$	180 $\Omega$	180 $\Omega$
$C_{TUNE}$	680 pF	1800 pF	3300 pF	4700 pF	5600 pF

Table 2. Recommended values of  $R_{TUNE}$  and  $C_{TUNE}$  to obtain transient deviation of  $\leq 2\%$  of  $V_{out}$  for a 3 A step load with  $V_{in} = 12\text{ V}$

V <sub>o</sub>	5 V	3.3 V	2.5 V	1.8 V	1.2 V	0.6 V
C <sub>o</sub>	2x47 μF	3x47 μF	3x47 μF	1x330 μF	2x330 μF Polymer	4x330 μF Polymer
R <sub>TUNE</sub>	270 Ω	180 Ω	180 Ω	180 Ω	180 Ω	180 Ω
C <sub>TUNE</sub>	2200 pF	3300 pF	3300 pF	4700 pF	12 nF	33 nF
ΔV	76 mV	48 mV	47 mV	33 mV	18 mV	10 mV

Table 3. Recommended values of R<sub>TUNE</sub> and C<sub>TUNE</sub> to obtain transient deviation of 2% of V<sub>out</sub> for a 3 A step load with V<sub>in</sub> = 12 V

**Note:** The capacitors used in the Tunable Loop tables are 47 μF/3 mΩ ESR ceramic and 330 μF/12 mΩ ESR polymer capacitors.

### 39. POWER MANAGEMENT BUS INTERFACE CAPABILITY

The SLDN-06D1Ax modules have a Power Management Bus interface that supports both communication and control. The Power Management Bus Power Management Protocol Specification can be obtained from [www.PowerManagementBus.org](http://www.PowerManagementBus.org). The modules support a subset of version 1.1 of the specification (see Table 6 for a list of the specific commands supported). Most module parameters can be programmed using Power Management Bus and stored as defaults for later use.

All communication over the module Power Management Bus interface must support the Packet Error Checking (PEC) scheme. The Power Management Bus master must generate the correct PEC byte for all transactions, and check the PEC byte returned by the module.

The module also supports the SMBALERT response protocol whereby the module can alert the bus master if it wants to talk. For more information on the SMBus alert response protocol, see the System Management Bus (SMBus) specification.

The module has non-volatile memory that is used to store configuration settings. Not all settings programmed into the device are automatically saved into this non-volatile memory, only those specifically identified as capable of being stored can be saved (see Table 6 for which command parameters can be saved to non-volatile storage).

### 40. POWER MANAGEMENT BUS DATA FORMAT

For commands that set thresholds, voltages or report such quantities, the module supports the “Linear” data format among the three data formats supported by Power Management Bus. The Linear Data Format is a two byte value with an 11-bit, two’s complement mantissa and a 5-bit, two’s complement exponent. The format of the two data bytes is shown below:

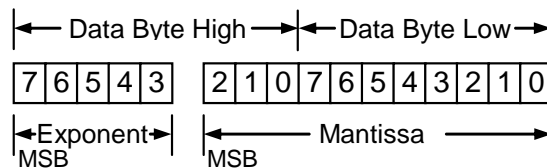

The value of the number is then given by  
 $Value = Mantissa \times 2^{Exponent}$



**Asia-Pacific**    **Europe, Middle East**    **North America**  
 +86 755 298 85888    +353 61 49 8941    +1 866 513 2839

## 41. POWER MANAGEMENT BUS ADDRESSING

The SLDN-06D1Ax module can be addressed through the Power Management Bus using a device address. The module has 64 possible addresses (0 to 63 in decimal) which can be set using resistors connected from the ADDR0 and ADDR1 pins to SIG\_GND. Note that some of these addresses (0, 1, 2, 3, 4, 5, 6, 7, 8, 12, 40 in decimal) are reserved according to the SMBus specifications and may not be useable. The address is set in the form of two octal (0 to 7) digits, with each pin setting one digit. The ADDR1 pin sets the high order digit and ADDR0 sets the low order digit. The resistor values suggested for each digit are shown in Table 4 (1% tolerance resistors are recommended). Note that if either address resistor value is outside the range specified in Table 4, the module will respond to address 127.

DIGIT	RESISTOR VALUE (k $\Omega$ )
0	10
1	15.4
2	23.7
3	36.5
4	54.9
5	84.5
6	130
7	200

Table 4.

The user must know which I2C addresses are reserved in a system for special functions and set the address of the module to avoid interfering with other system operations. Both 100 kHz and 400 kHz bus speeds are supported by the module. Connection for the Power Management Bus interface should follow the High Power DC specifications given in section 3.1.3 in the SMBus specification V2.0 for the 400 kHz bus speed or the Low Power DC specifications in section 3.1.2. The complete SMBus specification is available from the SMBus web site, [smbus.org](http://smbus.org).

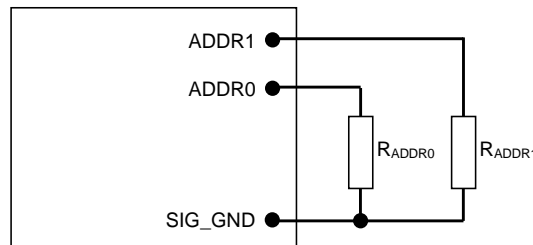

Figure 48.

Circuit showing connection of resistors used to set the Power Management Bus address of the module.



## 42. POWER MANAGEMENT BUS ENABLE ON/OFF

The module can also be turned on and off via the Power Management Bus interface. The OPERATION command is used to actually turn the module on and off via the Power Management Bus, while the ON\_OFF\_CONFIG command configures the combination of analog ON/OFF pin input and Power Management Bus commands needed to turn the module on and off. Bit [7] in the OPERATION command data byte enables the module, with the following functions:

0: Output is disabled

1: Output is enabled

This module uses the lower five bits of the ON\_OFF\_CONFIG data byte to set various ON/OFF options as follows:

BIT POSITION	4	3	2	1	0
Access	r/w	r/w	r/w	r/w	r
Function	PU	CMD	CPR	POL	CPA
Default Value	1	0	1	1	1

PU: Sets the default to either operate any time input power is present or for the ON/OFF to be controlled by the analog ON/OFF input and the Power Management Bus OPERATION command. This bit is used together with the CP, CMD and ON bits to determine startup.

BIT VALUE	ACTION
0	Module powers up any time power is present regardless of state of the analog ON/OFF pin
1	Module does not power up until commanded by the analog ON/OFF pin and the OPERATION command as programmed in bits [2:0] of the ON_OFF_CONFIG register.

CMD: The CMD bit controls how the device responds to the OPERATION command.

BIT VALUE	ACTION
0	Module ignores the ON bit in the OPERATION command
1	Module responds to the ON bit in the OPERATION command

CPR: Sets the response of the analog ON/OFF pin. This bit is used together with the CMD, PU and ON bits to determine startup.

BIT VALUE	ACTION
0	Module ignores the analog ON/OFF pin, i.e. ON/OFF is only controlled through the POWER MANAGEMENT BUS via the OPERATION command
1	Module requires the analog ON/OFF pin to be asserted to start the unit

### 43. POWER MANAGEMENT BUS ADJUSTABLE SOFT START RISE TIME

The soft start rise time can be adjusted in the module via Power Management Bus. When setting this parameter, make sure that the charging current for output capacitors can be delivered by the module in addition to any load current to avoid nuisance tripping of the overcurrent protection circuitry during startup. The TON\_RISE command sets the rise time in ms, and allows choosing soft start times between 600  $\mu$ s and 9 ms, with possible values listed in Table 5. Note that the exponent is fixed at -4 (decimal) and the upper two bits of the mantissa are also fixed at 0.

RISE TIME	EXPONENT	MANTISSA
600 $\mu$ s	11100	00000001010
900 $\mu$ s	11100	00000001110
1.2ms	11100	00000010011
1.8ms	11100	00000011101
2.7ms	11100	00000101011
4.2ms	11100	00001000011
6.0ms	11100	00001100000
9.0ms	11100	00010010000

Table 5.

#### 44. OUTPUT VOLTAGE ADJUSTMENT USING THE POWER MANAGEMENT BUS

The VOUT\_SCALE\_LOOP parameter is important for a number of Power Management Bus commands related to output voltage trimming, margining, over/under voltage protection and the PGOOD thresholds. The output voltage of the module is set as the combination of the voltage divider formed by RTrim and a 20kΩ upper divider resistor inside the module, and the internal reference voltage of the module. The reference voltage VREF is nominally set at 600mV, and the output regulation voltage is then given by.

$$V_{OUT} = \left[ \frac{20000 + RTrim}{RTrim} \right] \times V_{REF}$$

Hence the module output voltage is dependent on the value of RTrim which is connected external to the module. The information on the output voltage divider ratio is conveyed to the module through the VOUT\_SCALE\_LOOP parameter which is calculated as follows:

$$VOUT\_SCALE\_LOOP = \frac{RTrim}{20000 + RTrim}$$

The VOUT\_SCALE\_LOOP parameter is specified using the “Linear” format and two bytes. The upper five bits [7:3] of the high byte are used to set the exponent which is fixed at -9 (decimal). The remaining three bits of the high byte [2:0] and the eight bits of the lower byte are used for the mantissa. The default value of the mantissa is 0010000000 corresponding to 256 (decimal), corresponding to a divider ratio of 0.5. The maximum value of the mantissa is 512 corresponding to a divider ratio of 1. Note that the resolution of the VOUT\_SCALE\_LOOP command is 0.2%.

When Power Management Bus commands are used to trim or margin the output voltage, the value of VREF is what is changed inside the module, which in turn changes the regulated output voltage of the module.

The nominal output voltage of the module can be adjusted with a minimum step size of 0.4% over a ±25% range from nominal using the VOUT\_TRIM command over the Power Management Bus.

The VOUT\_TRIM command is used to apply a fixed offset voltage to the output voltage command value using the “Linear” mode with the exponent fixed at -10 (decimal). The value of the offset voltage is given by.

$$V_{OUT(offset)} = VOUT\_TRIM \times 2^{-10}$$

This offset voltage is added to the voltage set through the divider ratio and nominal VREF to produce the trimmed output voltage. The valid range in two’s complement for this command is -4000h to 3FFFh. The high order two bits of the high byte must both be either 0 or 1. If a value outside of the +/-25% adjustment range is given with this command, the module will set its output voltage to the nominal value (as if VOUT\_TRIM had been set to 0), assert SMBALRT#, set the CML bit in STATUS\_BYTE and the invalid data bit in STATUS\_CML.

#### 45. OUTPUT VOLTAGE MARGINING USING THE POWER MANAGEMENT BUS

The module can also have its output voltage margined via Power Management Bus commands. The command VOUT\_MARGIN\_HIGH sets the margin high voltage, while the command VOUT\_MARGIN\_LOW sets the margin low voltage. Both the VOUT\_MARGIN\_HIGH and VOUT\_MARGIN\_LOW commands use the “Linear” mode with the exponent fixed at -10 (decimal). Two bytes are used for the mantissa with the upper bit [7] of the high byte fixed at 0. The actual margined output voltage is a combination of the VOUT\_MARGIN\_HIGH or VOUT\_MARGIN\_LOW and the VOUT\_TRIM values as shown below:

$$V_{OUT(MH)} = (VOUT\_MARGIN\_HIGH + VOUT\_TRIM) \times 2^{-10}$$

$$V_{OUT(ML)} = (VOUT\_MARGIN\_LOW + VOUT\_TRIM) \times 2^{-10}$$

Note that the sum of the margin and trim voltages cannot be outside the  $\pm 25\%$  window around the nominal output voltage.

The data associated with VOUT\_MARGIN\_HIGH and VOUT\_MARGIN\_LOW can be stored to non-volatile memory using the STORE\_DEFAULT\_ALL command.

The module is commanded to go to the margined high or low voltages using the OPERATION command. Bits [5:2] are used to enable margining as follows:

- 00XX: Margin Off
- 0101: Margin Low (Ignore Fault)
- 0110: Margin Low (Act on Fault)
- 1001: Margin High (Ignore Fault)
- 1010: Margin High (Act on Fault)

#### 46. POWER MANAGEMENT BUS ADJUSTABLE OVERCURRENT WARNING

The SLDN-06D1Ax module can provide an overcurrent warning via the Power Management Bus. The threshold for the overcurrent warning can be set using the parameter IOUT\_OC\_WARN\_LIMIT. This command uses the “Linear” data format with a two byte data word where the upper five bits [7:3] of the high byte represent the exponent and the remaining three bits of the high byte [2:0] and the eight bits in the low byte represent the mantissa. The exponent is fixed at -1 (decimal). The upper six bits of the mantissa are fixed at 0 while the lower five bits are programmable with a default value of 7 A. The resolution of this warning limit is 500 mA. The value of the IOUT\_OC\_WARN\_LIMIT can be stored to non-volatile memory using the STORE\_DEFAULT\_ALL command.

#### 47. TEMPERATURE STATUS VIA POWER MANAGEMENT BUS

The SLDN-06D1Ax module can provide information related to temperature of the module through the STATUS\_TEMPERATURE command. The command returns information about whether the pre-set over temperature fault threshold and/or the warning threshold have been exceeded.

## 48. POWER MANAGEMENT BUS ADJUSTABLE OUTPUT OVER AND UNDER VOLTAGE PROTECTION

The SLDN-06D1Ax module can provide information related to temperature of the module through the STATUS\_TEMPERATURE command. The command returns information about whether the pre-set over temperature fault threshold and/or the warning threshold have been exceeded.

$$V_{OUT(OV\_REQ)} = (VOUT\_OV\_FAULT\_LIMIT) \times 2^{-10}$$

$$V_{OUT(UV\_REQ)} = (VOUT\_UV\_FAULT\_LIMIT) \times 2^{-10}$$

Values within the supported range for over and undervoltage detection thresholds will be set to the nearest fixed percentage. Note that the correct value for VOUT\_SCALE\_LOOP must be set in the module for the correct over or under voltage trip points to be calculated.

In addition to adjustable output voltage protection, the 6A Digital module can also be programmed for the response to the fault. The VOUT\_OV\_FAULT\_RESPONSE and VOUT\_UV\_FAULT\_RESPONSE commands specify the response to the fault. Both these commands use a single data byte with the possible options as shown below.

- Continue operation without interruption (Bits [7:6] = 00, Bits [5:3] = xxx).
- Continue for four switching cycles and then shut down if the fault is still present, followed by no restart or continuous restart (Bits [7:6] = 01, Bits [5:3] = 000 means no restart, Bits [5:3] = 111 means continuous restart).
- Immediate shut down followed by no restart or continuous restart (Bits [7:6] = 10, Bits [5:3] = 000 means no restart, Bits [5:3] = 111 means continuous restart).
- Module output is disabled when the fault is present and the output is enabled when the fault no longer exists (Bits [7:6] = 11, Bits [5:3] = xxx).

**Note:** That separate response choices are possible for output over voltage or under voltage faults.

## 49. POWER MANAGEMENT BUS ADJUSTABLE INPUT UNDERVOLTAGE LOCKOUT

The SLDN-06D1Ax module allows adjustment of the input under voltage lockout and hysteresis. The command VIN\_ON allows setting the input voltage turn on threshold, while the VIN\_OFF command sets the input voltage turn off threshold. For the VIN\_ON command, possible values are 2.75 V, and 3 V to 14 V in 0.5 V steps. For the VIN\_OFF command, possible values are 2.5 V to 14 V in 0.5 V steps. If other values are entered for either command, they will be mapped to the closest of the allowed values.

VIN\_ON must be set higher than VINPOWER MANAGEMENT BUS \_OFF. Attempting to write either VIN\_ON lower than VIN\_OFF or VIN\_OFF higher than VIN\_ON results in the new value being rejected, SMBALERT being asserted along with the CML bit in STATUS\_BYTE and the invalid data bit in STATUS\_CML.

Both the VIN\_ON and VIN\_OFF commands use the “Linear” format with two data bytes. The upper five bits represent the exponent (fixed at -2) and the remaining 11 bits represent the mantissa. For the mantissa, the four most significant bits are fixed at 0.

## 50. POWER GOOD

The SLDN-06D1Ax module provides a Power Good (PGOOD) signal that is implemented with an open-drain output to indicate that the output voltage is within the regulation limits of the power module. The PGOOD signal will be de-asserted to a low state if any condition such as overtemperature, overcurrent or loss of regulation occurs that would result in the output voltage going outside the specified thresholds. The PGOOD thresholds are user selectable via the Power Management Bus (the default values are as shown in the Feature Specifications Section). Each threshold is set up symmetrically above and below the nominal value. The POWER\_GOOD\_ON command sets the output voltage level above which PGOOD is asserted (lower threshold). For example, with a 1.2 V nominal output voltage, the POWER\_GOOD\_ON threshold can set the lower threshold to 1.14 or 1.1 V. Doing this will automatically set the upper thresholds to 1.26 or 1.3 V.

The POWER\_GOOD\_OFF command sets the level below which the PGOOD command is de-asserted. This command also sets two thresholds symmetrically placed around the nominal output voltage. Normally, the POWER\_GOOD\_ON threshold is set higher than the POWER\_GOOD\_OFF threshold.

Both POWER\_GOOD\_ON and POWER\_GOOD\_OFF commands use the “Linear” format with the exponent fixed at -10 (decimal). The two thresholds are given by:

$$V_{OUT(PGOOD\_ON)} = (POWER\_GOOD\_ON) \times 2^{-10}$$

$$V_{OUT(PGOOD\_OFF)} = (POWER\_GOOD\_OFF) \times 2^{-10}$$

Both commands use two data bytes with bit [7] of the high byte fixed at 0, while the remaining bits are r/w and used to set the mantissa using two's complement representation. Both commands also use the VOUT\_SCALE\_LOOP parameter so it must be set correctly. The default value of POWER\_GOOD\_ON is set at 1.1035 V and that of the POWER\_GOOD\_OFF is set at 1.08 V. The values associated with these commands can be stored in non-volatile memory using the STORE\_DEFAULT\_ALL command.

The PGOOD terminal can be connected through a pullup resistor (suggested value 100 K $\Omega$ ) to a source of 5 VDC or lower.

## 51. MEASUREMENT OF OUTPUT CURRENT, OUTPUT VOLTAGE AND INPUT VOLTAGE

The SLDN-06D1Ax module is capable of measuring key module parameters such as output current and voltage and input voltage and providing this information through the Power Management Bus interface. Roughly every 200  $\mu$ s, the module makes 16 measurements each of output current, voltage and input voltage. Average values of these 16 measurements are then calculated and placed in the appropriate registers. The values in the registers can then be read using the Power Management Bus interface.

## 52. MEASURING OUTPUT CURRENT USING THE POWER MANAGEMENT BUS

The module measures current by using the inductor winding resistance as a current sense element. The inductor winding resistance is then the current gain factor used to scale the measured voltage into a current reading. This gain factor is the argument of the IOUT\_CAL\_GAIN command, and consists of two bytes in the linear data format. The exponent uses the upper five bits [7:3] of the high data byte in two's complement format and is fixed at -15 (decimal). The remaining 11 bits in two's complement binary format represent the mantissa.

The current measurement accuracy is also improved by each module being calibrated during manufacture with the offset in the current reading. The IOUT\_CAL\_OFFSET command is used to store and read the current offset. The argument for this command consists of two bytes composed of a 5-bit exponent (fixed at -4) and a 11-bit mantissa. This command has a resolution of 62.5 mA and a range of -4000 mA to +3937.5 mA. During manufacture, each module is calibrated by measuring and storing the current gain factor and offset into non-volatile storage.

The READ\_IOUT command provides module average output current information. This command only supports positive or current sourced from the module. If the converter is sinking current a reading of 0 is provided. The READ\_IOUT command returns two bytes of data in the linear data format. The exponent uses the upper five bits [7:3] of the high data byte in two's complement format and is fixed at -4 (decimal). The remaining 11 bits in two's complement binary format represent the mantissa with the 11th bit fixed at 0 since only positive numbers are considered valid.

Note that the current reading provided by the module is not corrected for temperature. The temperature corrected current reading for module temperature TModule can be estimated using the following equation.

$$I_{OUT,CORR} = \frac{I_{READ\_OUT}}{1 + [(T_{IND} - 30) \times 0.00393]}$$

Where IOUT\_CORR is the temperature corrected value of the current measurement, IREAD\_OUT is the module current measurement value, TIND is the temperature of the inductor winding on the module. Since it may be difficult to measure TIND, it may be approximated by an estimate of the module temperature.

### Measuring Output Voltage Using the Power Management Bus

The SLDN-06D1Ax module can provide output voltage information using the READ\_VOUT command. The command returns two bytes of data all representing the mantissa while the exponent is fixed at -10 (decimal).

During manufacture of the module, offset and gain correction values are written into the non-volatile memory of the module. The command VOUT\_CAL\_OFFSET can be used to read and/or write the offset (two bytes consisting of a 16-bit mantissa in two's complement format) while the exponent is always fixed at -10 (decimal). The allowed range for this offset correction is -125 to 124 mV. The command VOUT\_CAL\_GAIN can be used to read and/or write the gain correction - two bytes consisting of a five-bit exponent (fixed at -8) and a 11-bit mantissa. The range of this correction factor is -0.125 V to +0.121 V, with a resolution of 0.004 V. The corrected output voltage reading is then given by:

$$V_{OUT}(Final) = [V_{OUT}(Initial) \times (1 + VOUT\_CAL\_GAIN)] + VOUT\_CAL\_OFFSET$$



Asia-Pacific	Europe, Middle East	North America
+86 755 298 85888	+353 61 49 8941	+1 866 513 2839

### 53. MEASURING INPUT VOLTAGE USING THE POWER MANAGEMENT BUS

The SLDN-06D1Ax module can provide output voltage information using the READ\_VIN command. The command returns two bytes of data in the linear format. The upper five bits [7:3] of the high data form the two's complement representation of the mantissa which is fixed at -5 (decimal). The remaining 11 bits are used for two's complement representation of the mantissa, with the 11th bit fixed at zero since only positive numbers are valid.

During module manufacture, offset and gain correction values are written into the non-volatile memory of the module. The command VIN\_CAL\_OFFSET can be used to read and/or write the offset - two bytes consisting of a five-bit exponent (fixed at -5) and a 11-bit mantissa in two's complement format. The allowed range for this offset correction is -2 to 1.968 V, and the resolution is 32 mV. The command VIN\_CAL\_GAIN can be used to read and/or write the gain correction - two bytes consisting of a five-bit exponent (fixed at -8) and a 11-bit mantissa. The range of this correction factor is -0.125 V to +0.121 V with a resolution of 0.004 V. The corrected output voltage reading is then given by:

$$V_{IN}(Final) = [V_{IN}(Initial) \times (1 + VIN\_CAL\_GAIN)] + VIN\_CAL\_OFFSET$$



## 54. READING THE STATUS OF THE MODULE USING THE POWER MANAGEMENT BUS

The SLDN-06D1Ax module supports a number of status information commands implemented in Power Management Bus. However, not all features are supported in these commands. A 1 in the bit position indicates the fault that is flagged.

**STATUS\_BYTE:** Returns one byte of information with a summary of the most critical device faults.

BIT POSITION	FLAG	DEFAULT VALUE
7	X	0
6	OFF	0
5	VOUT Overvoltage	0
4	IOUT Overcurrent	0
3	VIN Undervoltage	0
2	Temperature	0
1	CML (Comm. Memory Fault)	0
0	None of the above	0

**STATUS\_WORD:** Returns two bytes of information with a summary of the module's fault/warning conditions.

### Low Byte

BIT POSITION	FLAG	DEFAULT VALUE
7	X	0
6	OFF	0
5	VOUT Overvoltage	0
4	IOUT Overcurrent	0
3	VIN Undervoltage	0
2	Temperature	0
1	CML (Comm. Memory Fault)	0
0	None of the above	0

### High Byte

BIT POSITION	FLAG	DEFAULT VALUE
7	VOUT fault or warning	0
6	IOUT fault or warning	0
5	X	0
4	X	0
3	POWER_GOOD# (is negated)	0
2	X	0
1	X	0
0	X	0

**STATUS\_VOUT:** Returns one byte of information relating to the status of the module's output voltage related faults.

BIT POSITION	FLAG	DEFAULT VALUE
7	VOUT OV Fault	0
6	X	0
5	X	0
4	VOUT UV Fault	0
3	X	0
2	X	0
1	X	0
0	X	0

**STATUS\_IOUT:** Returns one byte of information relating to the status of the module's output voltage related faults.

BIT POSITION	FLAG	DEFAULT VALUE
7	IOUT OC Fault	DEFAULT VALUE
6	X	0
5	IOUT OC Warning	0
4	X	0
3	X	0
2	X	0
1	X	0
0	X	0

**STATUS\_TEMPERATURE:** Returns one byte of information relating to the status of the module's temperature related faults.

BIT POSITION	FLAG	DEFAULT VALUE
7	OT Fault	0
6	OT Warning	0
5	X	0
4	X	0
3	X	0
2	X	0
1	X	0
0	X	0

**STATUS\_CML:** Returns one byte of information relating to the status of the module's communication related faults.

BIT POSITION	FLAG	DEFAULT VALUE
7	Invalid/Unsupported Command	0
6	Invalid/Unsupported Command	0
5	Packet Error Check Failed	0
4	X	0
3	X	0
2	X	0
1	Other Communication Fault	0
0	X	0

**MFR\_VIN\_MIN:** Returns minimum input voltage as two data bytes of information in Linear format (upper five bits are exponent – fixed at -2, and lower 11 bits are mantissa in two's complement format – fixed at 12).

**MFR\_VOUT\_MIN:** Returns minimum output voltage as two data bytes of information in Linear format (upper five bits are exponent – fixed at -10, and lower 11 bits are mantissa in two's complement format – fixed at 614).

**MFR\_SPECIFIC\_00:** Returns information related to the type of module and revision number. Bits [7:2] in the Low Byte indicate the module type (000110 corresponds to the SLDN-06D1Ax series of module), while bits [7:3] indicate the revision number of the module.

#### Low Byte

BIT POSITION	FLAG	DEFAULT VALUE
7:2	Module Name	000110
1:0	Reserved	10

#### High Byte

BIT POSITION	FLAG	DEFAULT VALUE
7:3	Module Revision Number	None
2:0	Reserved	000

**55. SUMMARY OF SUPPORTED POWER MANAGEMENT BUS COMMANDS**

Please refer to the Power Management Bus 1.1 specification for more details of these commands.

Table 6

Hex Code	Command	Brief Description	Non-Volatile Memory Storage																																													
01	OPERATION	Turn Module on or off. Also used to margin the output voltage <table border="1"> <tr> <td><b>Format</b></td> <td colspan="8">Unsigned Binary</td> </tr> <tr> <td><b>Bit Position</b></td> <td>7</td> <td>6</td> <td>5</td> <td>4</td> <td>3</td> <td>2</td> <td>1</td> <td>0</td> </tr> <tr> <td><b>Access</b></td> <td>r/w</td> <td>r</td> <td>r/w</td> <td>r/w</td> <td>r/w</td> <td>r/w</td> <td>r</td> <td>r</td> </tr> <tr> <td><b>Function</b></td> <td>On</td> <td>X</td> <td colspan="4">Margin</td> <td>X</td> <td>X</td> </tr> <tr> <td><b>Default Value</b></td> <td>0</td> <td>0</td> <td>0</td> <td>0</td> <td>0</td> <td>0</td> <td>X</td> <td>X</td> </tr> </table>	<b>Format</b>	Unsigned Binary								<b>Bit Position</b>	7	6	5	4	3	2	1	0	<b>Access</b>	r/w	r	r/w	r/w	r/w	r/w	r	r	<b>Function</b>	On	X	Margin				X	X	<b>Default Value</b>	0	0	0	0	0	0	X	X	
<b>Format</b>	Unsigned Binary																																															
<b>Bit Position</b>	7	6	5	4	3	2	1	0																																								
<b>Access</b>	r/w	r	r/w	r/w	r/w	r/w	r	r																																								
<b>Function</b>	On	X	Margin				X	X																																								
<b>Default Value</b>	0	0	0	0	0	0	X	X																																								
02	ON_OFF_CONFIG	Configures the ON/OFF functionality as a combination of analog ON/OFF pin and PMBus commands <table border="1"> <tr> <td><b>Format</b></td> <td colspan="8">Unsigned Binary</td> </tr> <tr> <td><b>Bit Position</b></td> <td>7</td> <td>6</td> <td>5</td> <td>4</td> <td>3</td> <td>2</td> <td>1</td> <td>0</td> </tr> <tr> <td><b>Access</b></td> <td>r</td> <td>r</td> <td>r</td> <td>r/w</td> <td>r/w</td> <td>r/w</td> <td>r/w</td> <td>r</td> </tr> <tr> <td><b>Function</b></td> <td>X</td> <td>X</td> <td>X</td> <td>pu</td> <td>cmd</td> <td>cpr</td> <td>pol</td> <td>cpa</td> </tr> <tr> <td><b>Default Value</b></td> <td>0</td> <td>0</td> <td>0</td> <td>1</td> <td>0</td> <td>1</td> <td>1</td> <td>1</td> </tr> </table>	<b>Format</b>	Unsigned Binary								<b>Bit Position</b>	7	6	5	4	3	2	1	0	<b>Access</b>	r	r	r	r/w	r/w	r/w	r/w	r	<b>Function</b>	X	X	X	pu	cmd	cpr	pol	cpa	<b>Default Value</b>	0	0	0	1	0	1	1	1	YES
<b>Format</b>	Unsigned Binary																																															
<b>Bit Position</b>	7	6	5	4	3	2	1	0																																								
<b>Access</b>	r	r	r	r/w	r/w	r/w	r/w	r																																								
<b>Function</b>	X	X	X	pu	cmd	cpr	pol	cpa																																								
<b>Default Value</b>	0	0	0	1	0	1	1	1																																								
03	CLEAR_FAULTS	Clear any fault bits that may have been set, also releases the SMBALERT# signal if the device has been asserting it.																																														
10	WRITE_PROTECT	Used to control writing to the module via PMBus. Copies the current register setting in the module whose command code matches the value in the data byte into non-volatile memory (EEPROM) on the module <table border="1"> <tr> <td><b>Format</b></td> <td colspan="8">Unsigned Binary</td> </tr> <tr> <td><b>Bit Position</b></td> <td>7</td> <td>6</td> <td>5</td> <td>4</td> <td>3</td> <td>2</td> <td>1</td> <td>0</td> </tr> <tr> <td><b>Access</b></td> <td>r/w</td> <td>r/w</td> <td>r/w</td> <td>x</td> <td>x</td> <td>x</td> <td>x</td> <td>x</td> </tr> <tr> <td><b>Function</b></td> <td>bit7</td> <td>bit6</td> <td>bit5</td> <td>X</td> <td>X</td> <td>X</td> <td>X</td> <td>X</td> </tr> <tr> <td><b>Default Value</b></td> <td>0</td> <td>0</td> <td>0</td> <td>X</td> <td>X</td> <td>X</td> <td>X</td> <td>X</td> </tr> </table> <p>Bit5: 0 – Enables all writes as permitted in bit6 or bit7                      1 – Disables all writes except the WRITE_PROTECT, OPERATION and ON_OFF_CONFIG (bit 6 and bit7 must be 0)                      Bit 6: 0 – Enables all writes as permitted in bit5 or bit7                      1 – Disables all writes except for the WRITE_PROTECT and OPERATION commands (bit5 and bit7 must be 0)                      Bit7: 0 – Enables all writes as permitted in bit5 or bit6                      1 – Disables all writes except for the WRITE_PROTECT command (bit5 and bit6 must be 0)</p>	<b>Format</b>	Unsigned Binary								<b>Bit Position</b>	7	6	5	4	3	2	1	0	<b>Access</b>	r/w	r/w	r/w	x	x	x	x	x	<b>Function</b>	bit7	bit6	bit5	X	X	X	X	X	<b>Default Value</b>	0	0	0	X	X	X	X	X	YES
<b>Format</b>	Unsigned Binary																																															
<b>Bit Position</b>	7	6	5	4	3	2	1	0																																								
<b>Access</b>	r/w	r/w	r/w	x	x	x	x	x																																								
<b>Function</b>	bit7	bit6	bit5	X	X	X	X	X																																								
<b>Default Value</b>	0	0	0	X	X	X	X	X																																								
11	STORE_DEFAULT_ALL	Copies all current register settings in the module into non-volatile memory (EEPROM) on the module. Takes about 50ms for the command to execute.																																														
12	RESTORE_DEFAULT_ALL	Restores all current register settings in the module from values in the module non-volatile memory (EEPROM)																																														
13	STORE_DEFAULT_CODE	Copies the current register setting in the module whose command code matches the value in the data byte into non-volatile memory (EEPROM) on the module <table border="1"> <tr> <td><b>Bit Position</b></td> <td>7</td> <td>6</td> <td>5</td> <td>4</td> <td>3</td> <td>2</td> <td>1</td> <td>0</td> </tr> <tr> <td><b>Access</b></td> <td>w</td> <td>w</td> <td>w</td> <td>w</td> <td>w</td> <td>w</td> <td>w</td> <td>w</td> </tr> <tr> <td><b>Function</b></td> <td colspan="8">Command code</td> </tr> </table>	<b>Bit Position</b>	7	6	5	4	3	2	1	0	<b>Access</b>	w	w	w	w	w	w	w	w	<b>Function</b>	Command code																										
<b>Bit Position</b>	7	6	5	4	3	2	1	0																																								
<b>Access</b>	w	w	w	w	w	w	w	w																																								
<b>Function</b>	Command code																																															
14	RESTORE_DEFAULT_CODE	Restores the current register setting in the module whose command code matches the value in the data byte from the value in the module non-volatile memory (EEPROM) <table border="1"> <tr> <td><b>Bit Position</b></td> <td>7</td> <td>6</td> <td>5</td> <td>4</td> <td>3</td> <td>2</td> <td>1</td> <td>0</td> </tr> <tr> <td><b>Access</b></td> <td>w</td> <td>w</td> <td>w</td> <td>w</td> <td>w</td> <td>w</td> <td>w</td> <td>w</td> </tr> <tr> <td><b>Function</b></td> <td colspan="8">Command code</td> </tr> </table>	<b>Bit Position</b>	7	6	5	4	3	2	1	0	<b>Access</b>	w	w	w	w	w	w	w	w	<b>Function</b>	Command code																										
<b>Bit Position</b>	7	6	5	4	3	2	1	0																																								
<b>Access</b>	w	w	w	w	w	w	w	w																																								
<b>Function</b>	Command code																																															

Hex Code	Command	Brief Description	Non-Volatile Memory Storage																																																																																	
20	VOUT_MODE	<p>The module has MODE set to Linear and Exponent set to -10. These values cannot be changed</p> <table border="1"> <tr> <td><b>Bit Position</b></td> <td>7</td> <td>6</td> <td>5</td> <td>4</td> <td>3</td> <td>2</td> <td>1</td> <td>0</td> </tr> <tr> <td><b>Access</b></td> <td>r</td> <td>r</td> <td>r</td> <td>r</td> <td>r</td> <td>r</td> <td>r</td> <td>r</td> </tr> <tr> <td><b>Function</b></td> <td colspan="4">Mode</td> <td colspan="4">Exponent</td> </tr> <tr> <td><b>Default Value</b></td> <td>0</td> <td>0</td> <td>0</td> <td>1</td> <td>0</td> <td>1</td> <td>1</td> <td>0</td> </tr> </table>	<b>Bit Position</b>	7	6	5	4	3	2	1	0	<b>Access</b>	r	r	r	r	r	r	r	r	<b>Function</b>	Mode				Exponent				<b>Default Value</b>	0	0	0	1	0	1	1	0																																														
<b>Bit Position</b>	7	6	5	4	3	2	1	0																																																																												
<b>Access</b>	r	r	r	r	r	r	r	r																																																																												
<b>Function</b>	Mode				Exponent																																																																															
<b>Default Value</b>	0	0	0	1	0	1	1	0																																																																												
22	VOUT_TRIM	<p>Apply a fixed offset voltage to the output voltage command value</p> <table border="1"> <tr> <td><b>Format</b></td> <td colspan="8">Linear, two's complement binary</td> </tr> <tr> <td><b>Bit Position</b></td> <td>7</td> <td>6</td> <td>5</td> <td>4</td> <td>3</td> <td>2</td> <td>1</td> <td>0</td> </tr> <tr> <td><b>Access</b></td> <td>r/w</td> <td>r</td> <td>r/w</td> <td>r/w</td> <td>r/w</td> <td>r/w</td> <td>r/w</td> <td>r/w</td> </tr> <tr> <td><b>Function</b></td> <td colspan="8">High Byte</td> </tr> <tr> <td><b>Default Value</b></td> <td>0</td> <td>0</td> <td>0</td> <td>0</td> <td>0</td> <td>0</td> <td>0</td> <td>0</td> </tr> <tr> <td><b>Bit Position</b></td> <td>7</td> <td>6</td> <td>5</td> <td>4</td> <td>3</td> <td>2</td> <td>1</td> <td>0</td> </tr> <tr> <td><b>Access</b></td> <td>r/w</td> <td>r/w</td> <td>r/w</td> <td>r/w</td> <td>r/w</td> <td>r/w</td> <td>r/w</td> <td>r/w</td> </tr> <tr> <td><b>Function</b></td> <td colspan="8">Low Byte</td> </tr> <tr> <td><b>Default Value</b></td> <td>0</td> <td>0</td> <td>0</td> <td>0</td> <td>0</td> <td>0</td> <td>0</td> <td>0</td> </tr> </table>	<b>Format</b>	Linear, two's complement binary								<b>Bit Position</b>	7	6	5	4	3	2	1	0	<b>Access</b>	r/w	r	r/w	r/w	r/w	r/w	r/w	r/w	<b>Function</b>	High Byte								<b>Default Value</b>	0	0	0	0	0	0	0	0	<b>Bit Position</b>	7	6	5	4	3	2	1	0	<b>Access</b>	r/w	r/w	r/w	r/w	r/w	r/w	r/w	r/w	<b>Function</b>	Low Byte								<b>Default Value</b>	0	0	0	0	0	0	0	0	YES
<b>Format</b>	Linear, two's complement binary																																																																																			
<b>Bit Position</b>	7	6	5	4	3	2	1	0																																																																												
<b>Access</b>	r/w	r	r/w	r/w	r/w	r/w	r/w	r/w																																																																												
<b>Function</b>	High Byte																																																																																			
<b>Default Value</b>	0	0	0	0	0	0	0	0																																																																												
<b>Bit Position</b>	7	6	5	4	3	2	1	0																																																																												
<b>Access</b>	r/w	r/w	r/w	r/w	r/w	r/w	r/w	r/w																																																																												
<b>Function</b>	Low Byte																																																																																			
<b>Default Value</b>	0	0	0	0	0	0	0	0																																																																												
25	VOUT_MARGIN_HIGH	<p>Sets the target voltage for margining the output high</p> <table border="1"> <tr> <td><b>Format</b></td> <td colspan="8">Linear, two's complement binary</td> </tr> <tr> <td><b>Bit Position</b></td> <td>7</td> <td>6</td> <td>5</td> <td>4</td> <td>3</td> <td>2</td> <td>1</td> <td>0</td> </tr> <tr> <td><b>Access</b></td> <td>r</td> <td>r/w</td> <td>r/w</td> <td>r/w</td> <td>r/w</td> <td>r/w</td> <td>r/w</td> <td>r/w</td> </tr> <tr> <td><b>Function</b></td> <td colspan="8">High Byte</td> </tr> <tr> <td><b>Default Value</b></td> <td>0</td> <td>0</td> <td>0</td> <td>0</td> <td>0</td> <td>1</td> <td>0</td> <td>1</td> </tr> <tr> <td><b>Bit Position</b></td> <td>7</td> <td>6</td> <td>5</td> <td>4</td> <td>3</td> <td>2</td> <td>1</td> <td>0</td> </tr> <tr> <td><b>Access</b></td> <td>r/w</td> <td>r/w</td> <td>r/w</td> <td>r/w</td> <td>r/w</td> <td>r/w</td> <td>r/w</td> <td>r/w</td> </tr> <tr> <td><b>Function</b></td> <td colspan="8">Low Byte</td> </tr> <tr> <td><b>Default Value</b></td> <td>0</td> <td>1</td> <td>0</td> <td>0</td> <td>0</td> <td>1</td> <td>1</td> <td>1</td> </tr> </table>	<b>Format</b>	Linear, two's complement binary								<b>Bit Position</b>	7	6	5	4	3	2	1	0	<b>Access</b>	r	r/w	r/w	r/w	r/w	r/w	r/w	r/w	<b>Function</b>	High Byte								<b>Default Value</b>	0	0	0	0	0	1	0	1	<b>Bit Position</b>	7	6	5	4	3	2	1	0	<b>Access</b>	r/w	r/w	r/w	r/w	r/w	r/w	r/w	r/w	<b>Function</b>	Low Byte								<b>Default Value</b>	0	1	0	0	0	1	1	1	YES
<b>Format</b>	Linear, two's complement binary																																																																																			
<b>Bit Position</b>	7	6	5	4	3	2	1	0																																																																												
<b>Access</b>	r	r/w	r/w	r/w	r/w	r/w	r/w	r/w																																																																												
<b>Function</b>	High Byte																																																																																			
<b>Default Value</b>	0	0	0	0	0	1	0	1																																																																												
<b>Bit Position</b>	7	6	5	4	3	2	1	0																																																																												
<b>Access</b>	r/w	r/w	r/w	r/w	r/w	r/w	r/w	r/w																																																																												
<b>Function</b>	Low Byte																																																																																			
<b>Default Value</b>	0	1	0	0	0	1	1	1																																																																												
26	VOUT_MARGIN_LOW	<p>Sets the target voltage for margining the output low</p> <table border="1"> <tr> <td><b>Format</b></td> <td colspan="8">Linear, two's complement binary</td> </tr> <tr> <td><b>Bit Position</b></td> <td>7</td> <td>6</td> <td>5</td> <td>4</td> <td>3</td> <td>2</td> <td>1</td> <td>0</td> </tr> <tr> <td><b>Access</b></td> <td>r</td> <td>r/w</td> <td>r/w</td> <td>r/w</td> <td>r/w</td> <td>r/w</td> <td>r/w</td> <td>r/w</td> </tr> <tr> <td><b>Function</b></td> <td colspan="8">High Byte</td> </tr> <tr> <td><b>Default Value</b></td> <td>0</td> <td>0</td> <td>0</td> <td>0</td> <td>0</td> <td>1</td> <td>0</td> <td>0</td> </tr> <tr> <td><b>Bit Position</b></td> <td>7</td> <td>6</td> <td>5</td> <td>4</td> <td>3</td> <td>2</td> <td>1</td> <td>0</td> </tr> <tr> <td><b>Access</b></td> <td>r/w</td> <td>r/w</td> <td>r/w</td> <td>r/w</td> <td>r/w</td> <td>r/w</td> <td>r/w</td> <td>r/w</td> </tr> <tr> <td><b>Function</b></td> <td colspan="8">Low Byte</td> </tr> <tr> <td><b>Default Value</b></td> <td>0</td> <td>1</td> <td>0</td> <td>1</td> <td>0</td> <td>0</td> <td>0</td> <td>1</td> </tr> </table>	<b>Format</b>	Linear, two's complement binary								<b>Bit Position</b>	7	6	5	4	3	2	1	0	<b>Access</b>	r	r/w	r/w	r/w	r/w	r/w	r/w	r/w	<b>Function</b>	High Byte								<b>Default Value</b>	0	0	0	0	0	1	0	0	<b>Bit Position</b>	7	6	5	4	3	2	1	0	<b>Access</b>	r/w	r/w	r/w	r/w	r/w	r/w	r/w	r/w	<b>Function</b>	Low Byte								<b>Default Value</b>	0	1	0	1	0	0	0	1	YES
<b>Format</b>	Linear, two's complement binary																																																																																			
<b>Bit Position</b>	7	6	5	4	3	2	1	0																																																																												
<b>Access</b>	r	r/w	r/w	r/w	r/w	r/w	r/w	r/w																																																																												
<b>Function</b>	High Byte																																																																																			
<b>Default Value</b>	0	0	0	0	0	1	0	0																																																																												
<b>Bit Position</b>	7	6	5	4	3	2	1	0																																																																												
<b>Access</b>	r/w	r/w	r/w	r/w	r/w	r/w	r/w	r/w																																																																												
<b>Function</b>	Low Byte																																																																																			
<b>Default Value</b>	0	1	0	1	0	0	0	1																																																																												
29	VOUT_SCALE_LOOP	<p>Sets the scaling of the output voltage – equal to the feedback resistor divider ratio</p> <table border="1"> <tr> <td><b>Format</b></td> <td colspan="8">Linear, two's complement binary</td> </tr> <tr> <td><b>Bit Position</b></td> <td>7</td> <td>6</td> <td>5</td> <td>4</td> <td>3</td> <td>2</td> <td>1</td> <td>0</td> </tr> <tr> <td><b>Access</b></td> <td>r</td> <td>r</td> <td>r</td> <td>r</td> <td>r</td> <td>r</td> <td>r/w</td> <td>r/w</td> </tr> <tr> <td><b>Function</b></td> <td colspan="4">Exponent</td> <td colspan="4">Mantissa</td> </tr> <tr> <td><b>Default Value</b></td> <td>1</td> <td>0</td> <td>1</td> <td>1</td> <td>1</td> <td>0</td> <td>0</td> <td>1</td> </tr> <tr> <td><b>Bit Position</b></td> <td>7</td> <td>6</td> <td>5</td> <td>4</td> <td>3</td> <td>2</td> <td>1</td> <td>0</td> </tr> <tr> <td><b>Access</b></td> <td>r/w</td> <td>r/w</td> <td>r/w</td> <td>r/w</td> <td>r/w</td> <td>r/w</td> <td>r/w</td> <td>r/w</td> </tr> <tr> <td><b>Function</b></td> <td colspan="8">Mantissa</td> </tr> <tr> <td><b>Default Value</b></td> <td>0</td> <td>0</td> <td>0</td> <td>0</td> <td>0</td> <td>0</td> <td>0</td> <td>0</td> </tr> </table>	<b>Format</b>	Linear, two's complement binary								<b>Bit Position</b>	7	6	5	4	3	2	1	0	<b>Access</b>	r	r	r	r	r	r	r/w	r/w	<b>Function</b>	Exponent				Mantissa				<b>Default Value</b>	1	0	1	1	1	0	0	1	<b>Bit Position</b>	7	6	5	4	3	2	1	0	<b>Access</b>	r/w	r/w	r/w	r/w	r/w	r/w	r/w	r/w	<b>Function</b>	Mantissa								<b>Default Value</b>	0	0	0	0	0	0	0	0	YES
<b>Format</b>	Linear, two's complement binary																																																																																			
<b>Bit Position</b>	7	6	5	4	3	2	1	0																																																																												
<b>Access</b>	r	r	r	r	r	r	r/w	r/w																																																																												
<b>Function</b>	Exponent				Mantissa																																																																															
<b>Default Value</b>	1	0	1	1	1	0	0	1																																																																												
<b>Bit Position</b>	7	6	5	4	3	2	1	0																																																																												
<b>Access</b>	r/w	r/w	r/w	r/w	r/w	r/w	r/w	r/w																																																																												
<b>Function</b>	Mantissa																																																																																			
<b>Default Value</b>	0	0	0	0	0	0	0	0																																																																												

Hex Code	Command	Brief Description	Non-Volatile Memory Storage																																																																																		
35	VIN_ON	<p>Sets the value of input voltage at which the module turns on</p> <table border="1"> <tr> <td><b>Format</b></td> <td colspan="8">Linear, two's complement binary</td> </tr> <tr> <td><b>Bit Position</b></td> <td>7</td><td>6</td><td>5</td><td>4</td><td>3</td><td>2</td><td>1</td><td>0</td> </tr> <tr> <td><b>Access</b></td> <td>r</td><td>r</td><td>r</td><td>r</td><td>r</td><td>r</td><td>r</td><td>r</td> </tr> <tr> <td><b>Function</b></td> <td colspan="4">Exponent</td> <td colspan="4">Mantissa</td> </tr> <tr> <td><b>Default Value</b></td> <td>1</td><td>1</td><td>1</td><td>1</td><td>0</td><td>0</td><td>0</td><td>0</td> </tr> <tr> <td><b>Bit Position</b></td> <td>7</td><td>6</td><td>5</td><td>4</td><td>3</td><td>2</td><td>1</td><td>0</td> </tr> <tr> <td><b>Access</b></td> <td>r</td><td>r/w</td><td>r/w</td><td>r/w</td><td>r/w</td><td>r/w</td><td>r/w</td><td>r/w</td> </tr> <tr> <td><b>Function</b></td> <td colspan="8">Mantissa</td> </tr> <tr> <td><b>Default Value</b></td> <td>0</td><td>0</td><td>0</td><td>0</td><td>0</td><td>1</td><td>1</td><td>1</td> </tr> </table>	<b>Format</b>	Linear, two's complement binary								<b>Bit Position</b>	7	6	5	4	3	2	1	0	<b>Access</b>	r	r	r	r	r	r	r	r	<b>Function</b>	Exponent				Mantissa				<b>Default Value</b>	1	1	1	1	0	0	0	0	<b>Bit Position</b>	7	6	5	4	3	2	1	0	<b>Access</b>	r	r/w	r/w	r/w	r/w	r/w	r/w	r/w	<b>Function</b>	Mantissa								<b>Default Value</b>	0	0	0	0	0	1	1	1	YES	
<b>Format</b>	Linear, two's complement binary																																																																																				
<b>Bit Position</b>	7	6	5	4	3	2	1	0																																																																													
<b>Access</b>	r	r	r	r	r	r	r	r																																																																													
<b>Function</b>	Exponent				Mantissa																																																																																
<b>Default Value</b>	1	1	1	1	0	0	0	0																																																																													
<b>Bit Position</b>	7	6	5	4	3	2	1	0																																																																													
<b>Access</b>	r	r/w	r/w	r/w	r/w	r/w	r/w	r/w																																																																													
<b>Function</b>	Mantissa																																																																																				
<b>Default Value</b>	0	0	0	0	0	1	1	1																																																																													
36	VIN_OFF	<p>Sets the value of input voltage at which the module turns off</p> <table border="1"> <tr> <td><b>Format</b></td> <td colspan="8">Linear, two's complement binary</td> </tr> <tr> <td><b>Bit Position</b></td> <td>7</td><td>6</td><td>5</td><td>4</td><td>3</td><td>2</td><td>1</td><td>0</td> </tr> <tr> <td><b>Access</b></td> <td>r</td><td>r</td><td>r</td><td>r</td><td>r</td><td>r</td><td>r</td><td>r</td> </tr> <tr> <td><b>Function</b></td> <td colspan="4">Exponent</td> <td colspan="4">Mantissa</td> </tr> <tr> <td><b>Default Value</b></td> <td>1</td><td>1</td><td>1</td><td>1</td><td>0</td><td>0</td><td>0</td><td>0</td> </tr> <tr> <td><b>Bit Position</b></td> <td>7</td><td>6</td><td>5</td><td>4</td><td>3</td><td>2</td><td>1</td><td>0</td> </tr> <tr> <td><b>Access</b></td> <td>r</td><td>r/w</td><td>r/w</td><td>r/w</td><td>r/w</td><td>r/w</td><td>r/w</td><td>r/w</td> </tr> <tr> <td><b>Function</b></td> <td colspan="8">Mantissa</td> </tr> <tr> <td><b>Default Value</b></td> <td>0</td><td>0</td><td>0</td><td>0</td><td>1</td><td>0</td><td>1</td><td>0</td> </tr> </table>	<b>Format</b>	Linear, two's complement binary								<b>Bit Position</b>	7	6	5	4	3	2	1	0	<b>Access</b>	r	r	r	r	r	r	r	r	<b>Function</b>	Exponent				Mantissa				<b>Default Value</b>	1	1	1	1	0	0	0	0	<b>Bit Position</b>	7	6	5	4	3	2	1	0	<b>Access</b>	r	r/w	r/w	r/w	r/w	r/w	r/w	r/w	<b>Function</b>	Mantissa								<b>Default Value</b>	0	0	0	0	1	0	1	0	YES	
<b>Format</b>	Linear, two's complement binary																																																																																				
<b>Bit Position</b>	7	6	5	4	3	2	1	0																																																																													
<b>Access</b>	r	r	r	r	r	r	r	r																																																																													
<b>Function</b>	Exponent				Mantissa																																																																																
<b>Default Value</b>	1	1	1	1	0	0	0	0																																																																													
<b>Bit Position</b>	7	6	5	4	3	2	1	0																																																																													
<b>Access</b>	r	r/w	r/w	r/w	r/w	r/w	r/w	r/w																																																																													
<b>Function</b>	Mantissa																																																																																				
<b>Default Value</b>	0	0	0	0	1	0	1	0																																																																													
38	IOUT_CAL_GAIN	<p>Returns the value of the gain correction term used to correct the measured output current</p> <table border="1"> <tr> <td><b>Format</b></td> <td colspan="8">Linear, two's complement binary</td> </tr> <tr> <td><b>Bit Position</b></td> <td>7</td><td>6</td><td>5</td><td>4</td><td>3</td><td>2</td><td>1</td><td>0</td> </tr> <tr> <td><b>Access</b></td> <td>r</td><td>r</td><td>r</td><td>r</td><td>r</td><td>r</td><td>r</td><td>r/w</td> </tr> <tr> <td><b>Function</b></td> <td colspan="4">Exponent</td> <td colspan="4">Mantissa</td> </tr> <tr> <td><b>Default Value</b></td> <td>1</td><td>0</td><td>0</td><td>0</td><td>1</td><td>0</td><td>0</td><td>V</td> </tr> <tr> <td><b>Bit Position</b></td> <td>7</td><td>6</td><td>5</td><td>4</td><td>3</td><td>2</td><td>1</td><td>0</td> </tr> <tr> <td><b>Access</b></td> <td>r/w</td><td>r/w</td><td>r/w</td><td>r/w</td><td>r/w</td><td>r/w</td><td>r/w</td><td>r/w</td> </tr> <tr> <td><b>Function</b></td> <td colspan="8">Mantissa</td> </tr> <tr> <td><b>Default Value</b></td> <td colspan="8">V: Variable based on factory calibration</td> </tr> </table>	<b>Format</b>	Linear, two's complement binary								<b>Bit Position</b>	7	6	5	4	3	2	1	0	<b>Access</b>	r	r	r	r	r	r	r	r/w	<b>Function</b>	Exponent				Mantissa				<b>Default Value</b>	1	0	0	0	1	0	0	V	<b>Bit Position</b>	7	6	5	4	3	2	1	0	<b>Access</b>	r/w	r/w	r/w	r/w	r/w	r/w	r/w	r/w	<b>Function</b>	Mantissa								<b>Default Value</b>	V: Variable based on factory calibration								YES	
<b>Format</b>	Linear, two's complement binary																																																																																				
<b>Bit Position</b>	7	6	5	4	3	2	1	0																																																																													
<b>Access</b>	r	r	r	r	r	r	r	r/w																																																																													
<b>Function</b>	Exponent				Mantissa																																																																																
<b>Default Value</b>	1	0	0	0	1	0	0	V																																																																													
<b>Bit Position</b>	7	6	5	4	3	2	1	0																																																																													
<b>Access</b>	r/w	r/w	r/w	r/w	r/w	r/w	r/w	r/w																																																																													
<b>Function</b>	Mantissa																																																																																				
<b>Default Value</b>	V: Variable based on factory calibration																																																																																				
39	IOUT_CAL_OFFSET	<p>Returns the value of the offset correction term used to correct the measured output current</p> <table border="1"> <tr> <td><b>Format</b></td> <td colspan="8">Linear, two's complement binary</td> </tr> <tr> <td><b>Bit Position</b></td> <td>7</td><td>6</td><td>5</td><td>4</td><td>3</td><td>2</td><td>1</td><td>0</td> </tr> <tr> <td><b>Access</b></td> <td>r</td><td>r</td><td>r</td><td>r</td><td>r</td><td>r/w</td><td>r</td><td>r</td> </tr> <tr> <td><b>Function</b></td> <td colspan="4">Exponent</td> <td colspan="4">Mantissa</td> </tr> <tr> <td><b>Default Value</b></td> <td>1</td><td>1</td><td>1</td><td>0</td><td>0</td><td>V</td><td>0</td><td>0</td> </tr> <tr> <td><b>Bit Position</b></td> <td>7</td><td>6</td><td>5</td><td>4</td><td>3</td><td>2</td><td>1</td><td>0</td> </tr> <tr> <td><b>Access</b></td> <td>r</td><td>r</td><td>r/w</td><td>r/w</td><td>r/w</td><td>r/w</td><td>r/w</td><td>r/w</td> </tr> <tr> <td><b>Function</b></td> <td colspan="8">Mantissa</td> </tr> <tr> <td><b>Default Value</b></td> <td>0</td><td>0</td><td colspan="6">V: Variable based on factory calibration</td><td></td> </tr> </table>	<b>Format</b>	Linear, two's complement binary								<b>Bit Position</b>	7	6	5	4	3	2	1	0	<b>Access</b>	r	r	r	r	r	r/w	r	r	<b>Function</b>	Exponent				Mantissa				<b>Default Value</b>	1	1	1	0	0	V	0	0	<b>Bit Position</b>	7	6	5	4	3	2	1	0	<b>Access</b>	r	r	r/w	r/w	r/w	r/w	r/w	r/w	<b>Function</b>	Mantissa								<b>Default Value</b>	0	0	V: Variable based on factory calibration							YES
<b>Format</b>	Linear, two's complement binary																																																																																				
<b>Bit Position</b>	7	6	5	4	3	2	1	0																																																																													
<b>Access</b>	r	r	r	r	r	r/w	r	r																																																																													
<b>Function</b>	Exponent				Mantissa																																																																																
<b>Default Value</b>	1	1	1	0	0	V	0	0																																																																													
<b>Bit Position</b>	7	6	5	4	3	2	1	0																																																																													
<b>Access</b>	r	r	r/w	r/w	r/w	r/w	r/w	r/w																																																																													
<b>Function</b>	Mantissa																																																																																				
<b>Default Value</b>	0	0	V: Variable based on factory calibration																																																																																		
40	VOUT_OV_FAULT_LIMIT	<p>Sets the voltage level for an output overvoltage fault. Exponent is fixed at -10. Suggested value shown for 1.2Vo. Should be changed for different output voltage. Values can be 108%, 110%, 112% or 115% of output voltage</p> <table border="1"> <tr> <td><b>Format</b></td> <td colspan="8">Linear, two's complement binary</td> </tr> <tr> <td><b>Bit Position</b></td> <td>7</td><td>6</td><td>5</td><td>4</td><td>3</td><td>2</td><td>1</td><td>0</td> </tr> <tr> <td><b>Access</b></td> <td>r</td><td>r/w</td><td>r/w</td><td>r/w</td><td>r/w</td><td>r/w</td><td>r/w</td><td>r/w</td> </tr> <tr> <td><b>Function</b></td> <td colspan="8">High Byte</td> </tr> <tr> <td><b>Default Value</b></td> <td>0</td><td>0</td><td>0</td><td>0</td><td>0</td><td>1</td><td>0</td><td>1</td> </tr> <tr> <td><b>Bit Position</b></td> <td>7</td><td>6</td><td>5</td><td>4</td><td>3</td><td>2</td><td>1</td><td>0</td> </tr> <tr> <td><b>Access</b></td> <td>r/w</td><td>r/w</td><td>r/w</td><td>r/w</td><td>r/w</td><td>r/w</td><td>r/w</td><td>r/w</td> </tr> <tr> <td><b>Function</b></td> <td colspan="8">Low Byte</td> </tr> <tr> <td><b>Default Value</b></td> <td>0</td><td>1</td><td>1</td><td>0</td><td>0</td><td>0</td><td>0</td><td>0</td> </tr> </table>	<b>Format</b>	Linear, two's complement binary								<b>Bit Position</b>	7	6	5	4	3	2	1	0	<b>Access</b>	r	r/w	r/w	r/w	r/w	r/w	r/w	r/w	<b>Function</b>	High Byte								<b>Default Value</b>	0	0	0	0	0	1	0	1	<b>Bit Position</b>	7	6	5	4	3	2	1	0	<b>Access</b>	r/w	r/w	r/w	r/w	r/w	r/w	r/w	r/w	<b>Function</b>	Low Byte								<b>Default Value</b>	0	1	1	0	0	0	0	0	YES	
<b>Format</b>	Linear, two's complement binary																																																																																				
<b>Bit Position</b>	7	6	5	4	3	2	1	0																																																																													
<b>Access</b>	r	r/w	r/w	r/w	r/w	r/w	r/w	r/w																																																																													
<b>Function</b>	High Byte																																																																																				
<b>Default Value</b>	0	0	0	0	0	1	0	1																																																																													
<b>Bit Position</b>	7	6	5	4	3	2	1	0																																																																													
<b>Access</b>	r/w	r/w	r/w	r/w	r/w	r/w	r/w	r/w																																																																													
<b>Function</b>	Low Byte																																																																																				
<b>Default Value</b>	0	1	1	0	0	0	0	0																																																																													

Hex Code	Command	Brief Description	Non-Volatile Memory Storage																																																																																	
41	VOUT_OV_FAULT_RESPONSE	<p>Instructs the module on what action to take in response to a output overvoltage fault</p> <table border="1"> <tr> <td><b>Format</b></td> <td colspan="8">Unsigned Binary</td> </tr> <tr> <td><b>Bit Position</b></td> <td>7</td> <td>6</td> <td>5</td> <td>4</td> <td>3</td> <td>2</td> <td>1</td> <td>0</td> </tr> <tr> <td><b>Access</b></td> <td>r/w</td> <td>r/w</td> <td>r/w</td> <td>r/w</td> <td>r/w</td> <td>r</td> <td>r</td> <td>r</td> </tr> <tr> <td><b>Function</b></td> <td>RSP [1]</td> <td>RSP [0]</td> <td>RS[2]</td> <td>RS[1]</td> <td>RS[0]</td> <td>X</td> <td>X</td> <td>X</td> </tr> <tr> <td><b>Default Value</b></td> <td>1</td> <td>1</td> <td>1</td> <td>1</td> <td>1</td> <td>1</td> <td>0</td> <td>0</td> </tr> </table>	<b>Format</b>	Unsigned Binary								<b>Bit Position</b>	7	6	5	4	3	2	1	0	<b>Access</b>	r/w	r/w	r/w	r/w	r/w	r	r	r	<b>Function</b>	RSP [1]	RSP [0]	RS[2]	RS[1]	RS[0]	X	X	X	<b>Default Value</b>	1	1	1	1	1	1	0	0	YES																																				
<b>Format</b>	Unsigned Binary																																																																																			
<b>Bit Position</b>	7	6	5	4	3	2	1	0																																																																												
<b>Access</b>	r/w	r/w	r/w	r/w	r/w	r	r	r																																																																												
<b>Function</b>	RSP [1]	RSP [0]	RS[2]	RS[1]	RS[0]	X	X	X																																																																												
<b>Default Value</b>	1	1	1	1	1	1	0	0																																																																												
44	VOUT_UV_FAULT_LIMIT	<p>Sets the voltage level for an output undervoltage fault. Exponent is fixed at -10. Suggested value shown for 1.2Vo. Should be changed for different output voltage. Values can be 92%, 90%, 88% or 85% of output voltage</p> <table border="1"> <tr> <td><b>Format</b></td> <td colspan="8">Linear, two's complement binary</td> </tr> <tr> <td><b>Bit Position</b></td> <td>7</td> <td>6</td> <td>5</td> <td>4</td> <td>3</td> <td>2</td> <td>1</td> <td>0</td> </tr> <tr> <td><b>Access</b></td> <td>r</td> <td>r/w</td> <td>r/w</td> <td>r/w</td> <td>r/w</td> <td>r/w</td> <td>r/w</td> <td>r/w</td> </tr> <tr> <td><b>Function</b></td> <td colspan="8">High Byte</td> </tr> <tr> <td><b>Default Value</b></td> <td>0</td> <td>0</td> <td>0</td> <td>0</td> <td>0</td> <td>1</td> <td>0</td> <td>0</td> </tr> <tr> <td><b>Bit Position</b></td> <td>7</td> <td>6</td> <td>5</td> <td>4</td> <td>3</td> <td>2</td> <td>1</td> <td>0</td> </tr> <tr> <td><b>Access</b></td> <td>r/w</td> <td>r/w</td> <td>r/w</td> <td>r/w</td> <td>r/w</td> <td>r/w</td> <td>r/w</td> <td>r/w</td> </tr> <tr> <td><b>Function</b></td> <td colspan="8">Low Byte</td> </tr> <tr> <td><b>Default Value</b></td> <td>0</td> <td>0</td> <td>1</td> <td>1</td> <td>1</td> <td>0</td> <td>0</td> <td>1</td> </tr> </table>	<b>Format</b>	Linear, two's complement binary								<b>Bit Position</b>	7	6	5	4	3	2	1	0	<b>Access</b>	r	r/w	r/w	r/w	r/w	r/w	r/w	r/w	<b>Function</b>	High Byte								<b>Default Value</b>	0	0	0	0	0	1	0	0	<b>Bit Position</b>	7	6	5	4	3	2	1	0	<b>Access</b>	r/w	r/w	r/w	r/w	r/w	r/w	r/w	r/w	<b>Function</b>	Low Byte								<b>Default Value</b>	0	0	1	1	1	0	0	1	YES
<b>Format</b>	Linear, two's complement binary																																																																																			
<b>Bit Position</b>	7	6	5	4	3	2	1	0																																																																												
<b>Access</b>	r	r/w	r/w	r/w	r/w	r/w	r/w	r/w																																																																												
<b>Function</b>	High Byte																																																																																			
<b>Default Value</b>	0	0	0	0	0	1	0	0																																																																												
<b>Bit Position</b>	7	6	5	4	3	2	1	0																																																																												
<b>Access</b>	r/w	r/w	r/w	r/w	r/w	r/w	r/w	r/w																																																																												
<b>Function</b>	Low Byte																																																																																			
<b>Default Value</b>	0	0	1	1	1	0	0	1																																																																												
45	VOUT_UV_FAULT_RESPONSE	<p>Instructs the module on what action to take in response to a output undervoltage fault</p> <table border="1"> <tr> <td><b>Format</b></td> <td colspan="8">Unsigned Binary</td> </tr> <tr> <td><b>Bit Position</b></td> <td>7</td> <td>6</td> <td>5</td> <td>4</td> <td>3</td> <td>2</td> <td>1</td> <td>0</td> </tr> <tr> <td><b>Access</b></td> <td>r/w</td> <td>r/w</td> <td>r/w</td> <td>r/w</td> <td>r/w</td> <td>r</td> <td>r</td> <td>r</td> </tr> <tr> <td><b>Function</b></td> <td>RSP [1]</td> <td>RSP [0]</td> <td>RS[2]</td> <td>RS[1]</td> <td>RS[0]</td> <td>X</td> <td>X</td> <td>X</td> </tr> <tr> <td><b>Default Value</b></td> <td>0</td> <td>0</td> <td>0</td> <td>0</td> <td>0</td> <td>1</td> <td>0</td> <td>0</td> </tr> </table>	<b>Format</b>	Unsigned Binary								<b>Bit Position</b>	7	6	5	4	3	2	1	0	<b>Access</b>	r/w	r/w	r/w	r/w	r/w	r	r	r	<b>Function</b>	RSP [1]	RSP [0]	RS[2]	RS[1]	RS[0]	X	X	X	<b>Default Value</b>	0	0	0	0	0	1	0	0	YES																																				
<b>Format</b>	Unsigned Binary																																																																																			
<b>Bit Position</b>	7	6	5	4	3	2	1	0																																																																												
<b>Access</b>	r/w	r/w	r/w	r/w	r/w	r	r	r																																																																												
<b>Function</b>	RSP [1]	RSP [0]	RS[2]	RS[1]	RS[0]	X	X	X																																																																												
<b>Default Value</b>	0	0	0	0	0	1	0	0																																																																												
46	IOUT_OC_FAULT_LIMIT	<p>Sets the output overcurrent fault level in A (cannot be changed)</p> <table border="1"> <tr> <td><b>Format</b></td> <td colspan="8">Linear, two's complement binary</td> </tr> <tr> <td><b>Bit Position</b></td> <td>7</td> <td>6</td> <td>5</td> <td>4</td> <td>3</td> <td>2</td> <td>1</td> <td>0</td> </tr> <tr> <td><b>Access</b></td> <td>r</td> <td>r</td> <td>r</td> <td>r</td> <td>r</td> <td>r</td> <td>r</td> <td>r</td> </tr> <tr> <td><b>Function</b></td> <td colspan="4">Exponent</td> <td colspan="4">Mantissa</td> </tr> <tr> <td><b>Default Value</b></td> <td>1</td> <td>1</td> <td>1</td> <td>1</td> <td>1</td> <td>0</td> <td>0</td> <td>0</td> </tr> <tr> <td><b>Bit Position</b></td> <td>7</td> <td>6</td> <td>5</td> <td>4</td> <td>3</td> <td>2</td> <td>1</td> <td>0</td> </tr> <tr> <td><b>Access</b></td> <td>r</td> <td>r</td> <td>r</td> <td>r</td> <td>r</td> <td>r</td> <td>r</td> <td>R</td> </tr> <tr> <td><b>Function</b></td> <td colspan="8">Mantissa</td> </tr> <tr> <td><b>Default Value</b></td> <td>0</td> <td>0</td> <td>0</td> <td>1</td> <td>0</td> <td>0</td> <td>0</td> <td>0</td> </tr> </table>	<b>Format</b>	Linear, two's complement binary								<b>Bit Position</b>	7	6	5	4	3	2	1	0	<b>Access</b>	r	r	r	r	r	r	r	r	<b>Function</b>	Exponent				Mantissa				<b>Default Value</b>	1	1	1	1	1	0	0	0	<b>Bit Position</b>	7	6	5	4	3	2	1	0	<b>Access</b>	r	r	r	r	r	r	r	R	<b>Function</b>	Mantissa								<b>Default Value</b>	0	0	0	1	0	0	0	0	YES
<b>Format</b>	Linear, two's complement binary																																																																																			
<b>Bit Position</b>	7	6	5	4	3	2	1	0																																																																												
<b>Access</b>	r	r	r	r	r	r	r	r																																																																												
<b>Function</b>	Exponent				Mantissa																																																																															
<b>Default Value</b>	1	1	1	1	1	0	0	0																																																																												
<b>Bit Position</b>	7	6	5	4	3	2	1	0																																																																												
<b>Access</b>	r	r	r	r	r	r	r	R																																																																												
<b>Function</b>	Mantissa																																																																																			
<b>Default Value</b>	0	0	0	1	0	0	0	0																																																																												
4A	IOUT_OC_WARN_LIMIT	<p>Sets the output overcurrent warning level in A</p> <table border="1"> <tr> <td><b>Format</b></td> <td colspan="8">Linear, two's complement binary</td> </tr> <tr> <td><b>Bit Position</b></td> <td>7</td> <td>6</td> <td>5</td> <td>4</td> <td>3</td> <td>2</td> <td>1</td> <td>0</td> </tr> <tr> <td><b>Access</b></td> <td>r</td> <td>r</td> <td>r</td> <td>r</td> <td>r</td> <td>r</td> <td>r</td> <td>r</td> </tr> <tr> <td><b>Function</b></td> <td colspan="4">Exponent</td> <td colspan="4">Mantissa</td> </tr> <tr> <td><b>Default Value</b></td> <td>1</td> <td>1</td> <td>1</td> <td>1</td> <td>1</td> <td>0</td> <td>0</td> <td>0</td> </tr> <tr> <td><b>Bit Position</b></td> <td>7</td> <td>6</td> <td>5</td> <td>4</td> <td>3</td> <td>2</td> <td>1</td> <td>0</td> </tr> <tr> <td><b>Access</b></td> <td>r</td> <td>r</td> <td>r/w</td> <td>r/w</td> <td>r/w</td> <td>r/w</td> <td>r/w</td> <td>r/w</td> </tr> <tr> <td><b>Function</b></td> <td colspan="8">Mantissa</td> </tr> <tr> <td><b>Default Value</b></td> <td>0</td> <td>0</td> <td>0</td> <td>0</td> <td>1</td> <td>1</td> <td>1</td> <td>0</td> </tr> </table>	<b>Format</b>	Linear, two's complement binary								<b>Bit Position</b>	7	6	5	4	3	2	1	0	<b>Access</b>	r	r	r	r	r	r	r	r	<b>Function</b>	Exponent				Mantissa				<b>Default Value</b>	1	1	1	1	1	0	0	0	<b>Bit Position</b>	7	6	5	4	3	2	1	0	<b>Access</b>	r	r	r/w	r/w	r/w	r/w	r/w	r/w	<b>Function</b>	Mantissa								<b>Default Value</b>	0	0	0	0	1	1	1	0	YES
<b>Format</b>	Linear, two's complement binary																																																																																			
<b>Bit Position</b>	7	6	5	4	3	2	1	0																																																																												
<b>Access</b>	r	r	r	r	r	r	r	r																																																																												
<b>Function</b>	Exponent				Mantissa																																																																															
<b>Default Value</b>	1	1	1	1	1	0	0	0																																																																												
<b>Bit Position</b>	7	6	5	4	3	2	1	0																																																																												
<b>Access</b>	r	r	r/w	r/w	r/w	r/w	r/w	r/w																																																																												
<b>Function</b>	Mantissa																																																																																			
<b>Default Value</b>	0	0	0	0	1	1	1	0																																																																												

Hex Code	Command	Brief Description	Non-Volatile Memory Storage																																																																																	
5E	POWER_GOOD_ON	<p>Sets the output voltage level at which the PGOOD pin is asserted high</p> <table border="1"> <tr> <td><b>Format</b></td> <td colspan="8">Linear, two's complement binary</td> </tr> <tr> <td><b>Bit Position</b></td> <td>7</td><td>6</td><td>5</td><td>4</td><td>3</td><td>2</td><td>1</td><td>0</td> </tr> <tr> <td><b>Access</b></td> <td>r</td><td>r/w</td><td>r/w</td><td>r/w</td><td>r/w</td><td>r/w</td><td>r/w</td><td>r/w</td> </tr> <tr> <td><b>Function</b></td> <td colspan="8">High Byte</td> </tr> <tr> <td><b>Default Value</b></td> <td>0</td><td>0</td><td>0</td><td>0</td><td>0</td><td>1</td><td>0</td><td>0</td> </tr> <tr> <td><b>Bit Position</b></td> <td>7</td><td>6</td><td>5</td><td>4</td><td>3</td><td>2</td><td>1</td><td>0</td> </tr> <tr> <td><b>Access</b></td> <td>r/w</td><td>r/w</td><td>r/w</td><td>r/w</td><td>r/w</td><td>r/w</td><td>r/w</td><td>r/w</td> </tr> <tr> <td><b>Function</b></td> <td colspan="8">Low Byte</td> </tr> <tr> <td><b>Default Value</b></td> <td>0</td><td>1</td><td>1</td><td>0</td><td>1</td><td>0</td><td>1</td><td>0</td> </tr> </table>	<b>Format</b>	Linear, two's complement binary								<b>Bit Position</b>	7	6	5	4	3	2	1	0	<b>Access</b>	r	r/w	r/w	r/w	r/w	r/w	r/w	r/w	<b>Function</b>	High Byte								<b>Default Value</b>	0	0	0	0	0	1	0	0	<b>Bit Position</b>	7	6	5	4	3	2	1	0	<b>Access</b>	r/w	r/w	r/w	r/w	r/w	r/w	r/w	r/w	<b>Function</b>	Low Byte								<b>Default Value</b>	0	1	1	0	1	0	1	0	YES
<b>Format</b>	Linear, two's complement binary																																																																																			
<b>Bit Position</b>	7	6	5	4	3	2	1	0																																																																												
<b>Access</b>	r	r/w	r/w	r/w	r/w	r/w	r/w	r/w																																																																												
<b>Function</b>	High Byte																																																																																			
<b>Default Value</b>	0	0	0	0	0	1	0	0																																																																												
<b>Bit Position</b>	7	6	5	4	3	2	1	0																																																																												
<b>Access</b>	r/w	r/w	r/w	r/w	r/w	r/w	r/w	r/w																																																																												
<b>Function</b>	Low Byte																																																																																			
<b>Default Value</b>	0	1	1	0	1	0	1	0																																																																												
5F	POWER_GOOD_OFF	<p>Sets the output voltage level at which the PGOOD pin is de-asserted low</p> <table border="1"> <tr> <td><b>Format</b></td> <td colspan="8">Linear, two's complement binary</td> </tr> <tr> <td><b>Bit Position</b></td> <td>7</td><td>6</td><td>5</td><td>4</td><td>3</td><td>2</td><td>1</td><td>0</td> </tr> <tr> <td><b>Access</b></td> <td>r</td><td>r/w</td><td>r/w</td><td>r/w</td><td>r/w</td><td>r/w</td><td>r/w</td><td>r/w</td> </tr> <tr> <td><b>Function</b></td> <td colspan="8">High Byte</td> </tr> <tr> <td><b>Default Value</b></td> <td>0</td><td>0</td><td>0</td><td>0</td><td>0</td><td>1</td><td>0</td><td>0</td> </tr> <tr> <td><b>Bit Position</b></td> <td>7</td><td>6</td><td>5</td><td>4</td><td>3</td><td>2</td><td>1</td><td>0</td> </tr> <tr> <td><b>Access</b></td> <td>r/w</td><td>r/w</td><td>r/w</td><td>r/w</td><td>r/w</td><td>r/w</td><td>r/w</td><td>r/w</td> </tr> <tr> <td><b>Function</b></td> <td colspan="8">Low Byte</td> </tr> <tr> <td><b>Default Value</b></td> <td>0</td><td>1</td><td>0</td><td>1</td><td>0</td><td>0</td><td>1</td><td>0</td> </tr> </table>	<b>Format</b>	Linear, two's complement binary								<b>Bit Position</b>	7	6	5	4	3	2	1	0	<b>Access</b>	r	r/w	r/w	r/w	r/w	r/w	r/w	r/w	<b>Function</b>	High Byte								<b>Default Value</b>	0	0	0	0	0	1	0	0	<b>Bit Position</b>	7	6	5	4	3	2	1	0	<b>Access</b>	r/w	r/w	r/w	r/w	r/w	r/w	r/w	r/w	<b>Function</b>	Low Byte								<b>Default Value</b>	0	1	0	1	0	0	1	0	YES
<b>Format</b>	Linear, two's complement binary																																																																																			
<b>Bit Position</b>	7	6	5	4	3	2	1	0																																																																												
<b>Access</b>	r	r/w	r/w	r/w	r/w	r/w	r/w	r/w																																																																												
<b>Function</b>	High Byte																																																																																			
<b>Default Value</b>	0	0	0	0	0	1	0	0																																																																												
<b>Bit Position</b>	7	6	5	4	3	2	1	0																																																																												
<b>Access</b>	r/w	r/w	r/w	r/w	r/w	r/w	r/w	r/w																																																																												
<b>Function</b>	Low Byte																																																																																			
<b>Default Value</b>	0	1	0	1	0	0	1	0																																																																												
61	TON_RISE	<p>Sets the rise time of the output voltage during startup</p> <table border="1"> <tr> <td><b>Format</b></td> <td colspan="8">Linear, two's complement binary</td> </tr> <tr> <td><b>Bit Position</b></td> <td>7</td><td>6</td><td>5</td><td>4</td><td>3</td><td>2</td><td>1</td><td>0</td> </tr> <tr> <td><b>Access</b></td> <td>r</td><td>r</td><td>r</td><td>r</td><td>r</td><td>r</td><td>r</td><td>r/w</td> </tr> <tr> <td><b>Function</b></td> <td colspan="4">Exponent</td> <td colspan="4">Mantissa</td> </tr> <tr> <td><b>Default Value</b></td> <td>1</td><td>1</td><td>1</td><td>0</td><td>0</td><td>0</td><td>0</td><td>0</td> </tr> <tr> <td><b>Bit Position</b></td> <td>7</td><td>6</td><td>5</td><td>4</td><td>3</td><td>2</td><td>1</td><td>0</td> </tr> <tr> <td><b>Access</b></td> <td>r/w</td><td>r/w</td><td>r/w</td><td>r/w</td><td>r/w</td><td>r/w</td><td>r/w</td><td>r/w</td> </tr> <tr> <td><b>Function</b></td> <td colspan="8">Mantissa</td> </tr> <tr> <td><b>Default Value</b></td> <td>0</td><td>0</td><td>1</td><td>0</td><td>1</td><td>0</td><td>1</td><td>0</td> </tr> </table>	<b>Format</b>	Linear, two's complement binary								<b>Bit Position</b>	7	6	5	4	3	2	1	0	<b>Access</b>	r	r	r	r	r	r	r	r/w	<b>Function</b>	Exponent				Mantissa				<b>Default Value</b>	1	1	1	0	0	0	0	0	<b>Bit Position</b>	7	6	5	4	3	2	1	0	<b>Access</b>	r/w	r/w	r/w	r/w	r/w	r/w	r/w	r/w	<b>Function</b>	Mantissa								<b>Default Value</b>	0	0	1	0	1	0	1	0	YES
<b>Format</b>	Linear, two's complement binary																																																																																			
<b>Bit Position</b>	7	6	5	4	3	2	1	0																																																																												
<b>Access</b>	r	r	r	r	r	r	r	r/w																																																																												
<b>Function</b>	Exponent				Mantissa																																																																															
<b>Default Value</b>	1	1	1	0	0	0	0	0																																																																												
<b>Bit Position</b>	7	6	5	4	3	2	1	0																																																																												
<b>Access</b>	r/w	r/w	r/w	r/w	r/w	r/w	r/w	r/w																																																																												
<b>Function</b>	Mantissa																																																																																			
<b>Default Value</b>	0	0	1	0	1	0	1	0																																																																												
78	STATUS_BYTE	<p>Returns one byte of information with a summary of the most critical module faults</p> <table border="1"> <tr> <td><b>Format</b></td> <td colspan="8">Unsigned Binary</td> </tr> <tr> <td><b>Bit Position</b></td> <td>7</td><td>6</td><td>5</td><td>4</td><td>3</td><td>2</td><td>1</td><td>0</td> </tr> <tr> <td><b>Access</b></td> <td>r</td><td>r</td><td>r</td><td>r</td><td>r</td><td>r</td><td>r</td><td>r</td> </tr> <tr> <td><b>Flag</b></td> <td>X</td><td>OFF</td><td>VOUT_OV</td><td>IOUT_OC</td><td>VIN_UV</td><td>TEMP</td><td>CML</td><td>OTHE R</td> </tr> <tr> <td><b>Default Value</b></td> <td>0</td><td>0</td><td>0</td><td>0</td><td>0</td><td>0</td><td>0</td><td>0</td> </tr> </table>	<b>Format</b>	Unsigned Binary								<b>Bit Position</b>	7	6	5	4	3	2	1	0	<b>Access</b>	r	r	r	r	r	r	r	r	<b>Flag</b>	X	OFF	VOUT_OV	IOUT_OC	VIN_UV	TEMP	CML	OTHE R	<b>Default Value</b>	0	0	0	0	0	0	0	0																																					
<b>Format</b>	Unsigned Binary																																																																																			
<b>Bit Position</b>	7	6	5	4	3	2	1	0																																																																												
<b>Access</b>	r	r	r	r	r	r	r	r																																																																												
<b>Flag</b>	X	OFF	VOUT_OV	IOUT_OC	VIN_UV	TEMP	CML	OTHE R																																																																												
<b>Default Value</b>	0	0	0	0	0	0	0	0																																																																												
79	STATUS_WORD	<p>Returns two bytes of information with a summary of the module's fault/warning conditions</p> <table border="1"> <tr> <td><b>Format</b></td> <td colspan="8">Unsigned Binary</td> </tr> <tr> <td><b>Bit Position</b></td> <td>7</td><td>6</td><td>5</td><td>4</td><td>3</td><td>2</td><td>1</td><td>0</td> </tr> <tr> <td><b>Access</b></td> <td>r</td><td>r</td><td>r</td><td>r</td><td>r</td><td>r</td><td>r</td><td>r</td> </tr> <tr> <td><b>Flag</b></td> <td>VOUT</td><td>IOUT_OC</td><td>X</td><td>X</td><td>PGOOD</td><td>X</td><td>X</td><td>X</td> </tr> <tr> <td><b>Default Value</b></td> <td>0</td><td>0</td><td>0</td><td>0</td><td>0</td><td>0</td><td>0</td><td>0</td> </tr> <tr> <td><b>Bit Position</b></td> <td>7</td><td>6</td><td>5</td><td>4</td><td>3</td><td>2</td><td>1</td><td>0</td> </tr> <tr> <td><b>Access</b></td> <td>r</td><td>r</td><td>r</td><td>r</td><td>r</td><td>r</td><td>r</td><td>r</td> </tr> <tr> <td><b>Flag</b></td> <td>X</td><td>OFF</td><td>VOUT_OV</td><td>IOUT_OC</td><td>VIN_UV</td><td>TEMP</td><td>CML</td><td>OTHE R</td> </tr> <tr> <td><b>Default Value</b></td> <td>0</td><td>0</td><td>0</td><td>0</td><td>0</td><td>0</td><td>0</td><td>0</td> </tr> </table>	<b>Format</b>	Unsigned Binary								<b>Bit Position</b>	7	6	5	4	3	2	1	0	<b>Access</b>	r	r	r	r	r	r	r	r	<b>Flag</b>	VOUT	IOUT_OC	X	X	PGOOD	X	X	X	<b>Default Value</b>	0	0	0	0	0	0	0	0	<b>Bit Position</b>	7	6	5	4	3	2	1	0	<b>Access</b>	r	r	r	r	r	r	r	r	<b>Flag</b>	X	OFF	VOUT_OV	IOUT_OC	VIN_UV	TEMP	CML	OTHE R	<b>Default Value</b>	0	0	0	0	0	0	0	0	
<b>Format</b>	Unsigned Binary																																																																																			
<b>Bit Position</b>	7	6	5	4	3	2	1	0																																																																												
<b>Access</b>	r	r	r	r	r	r	r	r																																																																												
<b>Flag</b>	VOUT	IOUT_OC	X	X	PGOOD	X	X	X																																																																												
<b>Default Value</b>	0	0	0	0	0	0	0	0																																																																												
<b>Bit Position</b>	7	6	5	4	3	2	1	0																																																																												
<b>Access</b>	r	r	r	r	r	r	r	r																																																																												
<b>Flag</b>	X	OFF	VOUT_OV	IOUT_OC	VIN_UV	TEMP	CML	OTHE R																																																																												
<b>Default Value</b>	0	0	0	0	0	0	0	0																																																																												



Hex Code	Command	Brief Description	Non-Volatile Memory Storage																																																																																	
7A	STATUS_VOUT	<p>Returns one byte of information with the status of the module's output voltage related faults</p> <table border="1"> <tr> <th>Format</th> <td colspan="8">Unsigned Binary</td> </tr> <tr> <th>Bit Position</th> <td>7</td> <td>6</td> <td>5</td> <td>4</td> <td>3</td> <td>2</td> <td>1</td> <td>0</td> </tr> <tr> <th>Access</th> <td>r</td> <td>r</td> <td>r</td> <td>r</td> <td>r</td> <td>r</td> <td>r</td> <td>r</td> </tr> <tr> <th>Flag</th> <td>VOUT_OV</td> <td>X</td> <td>X</td> <td>VOUT_UV</td> <td>X</td> <td>X</td> <td>X</td> <td>X</td> </tr> <tr> <th>Default Value</th> <td>0</td> <td>0</td> <td>0</td> <td>0</td> <td>0</td> <td>0</td> <td>0</td> <td>0</td> </tr> </table>	Format	Unsigned Binary								Bit Position	7	6	5	4	3	2	1	0	Access	r	r	r	r	r	r	r	r	Flag	VOUT_OV	X	X	VOUT_UV	X	X	X	X	Default Value	0	0	0	0	0	0	0	0																																					
Format	Unsigned Binary																																																																																			
Bit Position	7	6	5	4	3	2	1	0																																																																												
Access	r	r	r	r	r	r	r	r																																																																												
Flag	VOUT_OV	X	X	VOUT_UV	X	X	X	X																																																																												
Default Value	0	0	0	0	0	0	0	0																																																																												
7B	STATUS_IOUT	<p>Returns one byte of information with the status of the module's output current related faults</p> <table border="1"> <tr> <th>Format</th> <td colspan="8">Unsigned Binary</td> </tr> <tr> <th>Bit Position</th> <td>7</td> <td>6</td> <td colspan="2">5</td> <td>4</td> <td>3</td> <td>2</td> <td>1</td> <td>0</td> </tr> <tr> <th>Access</th> <td>r</td> <td>r</td> <td colspan="2">r</td> <td>r</td> <td>r</td> <td>r</td> <td>r</td> <td>r</td> </tr> <tr> <th>Flag</th> <td>IOUT_OC</td> <td>X</td> <td colspan="2">IOUT_OC_WARN</td> <td>X</td> <td>X</td> <td>X</td> <td>X</td> <td>X</td> </tr> <tr> <th>Default Value</th> <td>0</td> <td>0</td> <td colspan="2">0</td> <td>0</td> <td>0</td> <td>0</td> <td>0</td> <td>0</td> </tr> </table>	Format	Unsigned Binary								Bit Position	7	6	5		4	3	2	1	0	Access	r	r	r		r	r	r	r	r	Flag	IOUT_OC	X	IOUT_OC_WARN		X	X	X	X	X	Default Value	0	0	0		0	0	0	0	0																																	
Format	Unsigned Binary																																																																																			
Bit Position	7	6	5		4	3	2	1	0																																																																											
Access	r	r	r		r	r	r	r	r																																																																											
Flag	IOUT_OC	X	IOUT_OC_WARN		X	X	X	X	X																																																																											
Default Value	0	0	0		0	0	0	0	0																																																																											
7D	STATUS_TEMPERATURE	<p>Returns one byte of information with the status of the module's temperature related faults</p> <table border="1"> <tr> <th>Format</th> <td colspan="8">Unsigned Binary</td> </tr> <tr> <th>Bit Position</th> <td>7</td> <td>6</td> <td>5</td> <td>4</td> <td>3</td> <td>2</td> <td>1</td> <td>0</td> </tr> <tr> <th>Access</th> <td>r</td> <td colspan="2">r</td> <td>r</td> <td>r</td> <td>r</td> <td>r</td> <td>r</td> </tr> <tr> <th>Flag</th> <td>OT_FAULT</td> <td colspan="2">OT_WARN</td> <td>X</td> <td>X</td> <td>X</td> <td>X</td> <td>X</td> </tr> <tr> <th>Default Value</th> <td>0</td> <td colspan="2">0</td> <td>0</td> <td>0</td> <td>0</td> <td>0</td> <td>0</td> </tr> </table>	Format	Unsigned Binary								Bit Position	7	6	5	4	3	2	1	0	Access	r	r		r	r	r	r	r	Flag	OT_FAULT	OT_WARN		X	X	X	X	X	Default Value	0	0		0	0	0	0	0																																					
Format	Unsigned Binary																																																																																			
Bit Position	7	6	5	4	3	2	1	0																																																																												
Access	r	r		r	r	r	r	r																																																																												
Flag	OT_FAULT	OT_WARN		X	X	X	X	X																																																																												
Default Value	0	0		0	0	0	0	0																																																																												
7E	STATUS_CML	<p>Returns one byte of information with the status of the module's communication related faults</p> <table border="1"> <tr> <th>Format</th> <td colspan="8">Unsigned Binary</td> </tr> <tr> <th>Bit Position</th> <td>7</td> <td>6</td> <td>5</td> <td>4</td> <td>3</td> <td>2</td> <td>1</td> <td>0</td> </tr> <tr> <th>Access</th> <td>r</td> <td>r</td> <td>r</td> <td>r</td> <td>r</td> <td>r</td> <td>r</td> <td>r</td> </tr> <tr> <th>Flag</th> <td>Invalid Command</td> <td>Invalid Data</td> <td>PEC Fail</td> <td>X</td> <td>X</td> <td>X</td> <td>Other Comm Fault</td> <td>X</td> </tr> <tr> <th>Default Value</th> <td>0</td> <td>0</td> <td>0</td> <td>0</td> <td>0</td> <td>0</td> <td>0</td> <td>0</td> </tr> </table>	Format	Unsigned Binary								Bit Position	7	6	5	4	3	2	1	0	Access	r	r	r	r	r	r	r	r	Flag	Invalid Command	Invalid Data	PEC Fail	X	X	X	Other Comm Fault	X	Default Value	0	0	0	0	0	0	0	0																																					
Format	Unsigned Binary																																																																																			
Bit Position	7	6	5	4	3	2	1	0																																																																												
Access	r	r	r	r	r	r	r	r																																																																												
Flag	Invalid Command	Invalid Data	PEC Fail	X	X	X	Other Comm Fault	X																																																																												
Default Value	0	0	0	0	0	0	0	0																																																																												
88	READ_VIN	<p>Returns the value of the input voltage applied to the module</p> <table border="1"> <tr> <th>Format</th> <td colspan="8">Linear, two's complement binary</td> </tr> <tr> <th>Bit Position</th> <td>7</td> <td>6</td> <td>5</td> <td>4</td> <td>3</td> <td>2</td> <td>1</td> <td>0</td> </tr> <tr> <th>Access</th> <td>r</td> <td>r</td> <td>r</td> <td>r</td> <td>r</td> <td>r</td> <td>r</td> <td>r</td> </tr> <tr> <th>Function</th> <td colspan="4">Exponent</td> <td colspan="4">Mantissa</td> </tr> <tr> <th>Default Value</th> <td>1</td> <td>1</td> <td>0</td> <td>1</td> <td>1</td> <td>0</td> <td>0</td> <td>0</td> </tr> <tr> <th>Bit Position</th> <td>7</td> <td>6</td> <td>5</td> <td>4</td> <td>3</td> <td>2</td> <td>1</td> <td>0</td> </tr> <tr> <th>Access</th> <td>r</td> <td>r</td> <td>r</td> <td>r</td> <td>r</td> <td>r</td> <td>r</td> <td>r</td> </tr> <tr> <th>Function</th> <td colspan="8">Mantissa</td> </tr> <tr> <th>Default Value</th> <td>0</td> <td>0</td> <td>0</td> <td>0</td> <td>0</td> <td>0</td> <td>0</td> <td>0</td> </tr> </table>	Format	Linear, two's complement binary								Bit Position	7	6	5	4	3	2	1	0	Access	r	r	r	r	r	r	r	r	Function	Exponent				Mantissa				Default Value	1	1	0	1	1	0	0	0	Bit Position	7	6	5	4	3	2	1	0	Access	r	r	r	r	r	r	r	r	Function	Mantissa								Default Value	0	0	0	0	0	0	0	0	
Format	Linear, two's complement binary																																																																																			
Bit Position	7	6	5	4	3	2	1	0																																																																												
Access	r	r	r	r	r	r	r	r																																																																												
Function	Exponent				Mantissa																																																																															
Default Value	1	1	0	1	1	0	0	0																																																																												
Bit Position	7	6	5	4	3	2	1	0																																																																												
Access	r	r	r	r	r	r	r	r																																																																												
Function	Mantissa																																																																																			
Default Value	0	0	0	0	0	0	0	0																																																																												
8B	READ_VOUT	<p>Returns the value of the output voltage of the module</p> <table border="1"> <tr> <th>Format</th> <td colspan="8">Linear, two's complement binary</td> </tr> <tr> <th>Bit Position</th> <td>7</td> <td>6</td> <td>5</td> <td>4</td> <td>3</td> <td>2</td> <td>1</td> <td>0</td> </tr> <tr> <th>Access</th> <td>r</td> <td>r</td> <td>r</td> <td>r</td> <td>r</td> <td>r</td> <td>r</td> <td>r</td> </tr> <tr> <th>Function</th> <td colspan="8">Mantissa</td> </tr> <tr> <th>Default Value</th> <td>0</td> <td>0</td> <td>0</td> <td>0</td> <td>0</td> <td>0</td> <td>0</td> <td>0</td> </tr> <tr> <th>Bit Position</th> <td>7</td> <td>6</td> <td>5</td> <td>4</td> <td>3</td> <td>2</td> <td>1</td> <td>0</td> </tr> <tr> <th>Access</th> <td>r</td> <td>r</td> <td>r</td> <td>r</td> <td>r</td> <td>r</td> <td>r</td> <td>r</td> </tr> <tr> <th>Function</th> <td colspan="8">Mantissa</td> </tr> <tr> <th>Default Value</th> <td>0</td> <td>0</td> <td>0</td> <td>0</td> <td>0</td> <td>0</td> <td>0</td> <td>0</td> </tr> </table>	Format	Linear, two's complement binary								Bit Position	7	6	5	4	3	2	1	0	Access	r	r	r	r	r	r	r	r	Function	Mantissa								Default Value	0	0	0	0	0	0	0	0	Bit Position	7	6	5	4	3	2	1	0	Access	r	r	r	r	r	r	r	r	Function	Mantissa								Default Value	0	0	0	0	0	0	0	0	
Format	Linear, two's complement binary																																																																																			
Bit Position	7	6	5	4	3	2	1	0																																																																												
Access	r	r	r	r	r	r	r	r																																																																												
Function	Mantissa																																																																																			
Default Value	0	0	0	0	0	0	0	0																																																																												
Bit Position	7	6	5	4	3	2	1	0																																																																												
Access	r	r	r	r	r	r	r	r																																																																												
Function	Mantissa																																																																																			
Default Value	0	0	0	0	0	0	0	0																																																																												

Hex Code	Command	Brief Description	Non-Volatile Memory Storage																																																																																	
8C	READ_IOUT	<p>Returns the value of the output current of the module</p> <table border="1"> <tr> <td><b>Format</b></td> <td colspan="8">Linear, two's complement binary</td> </tr> <tr> <td><b>Bit Position</b></td> <td>7</td> <td>6</td> <td>5</td> <td>4</td> <td>3</td> <td>2</td> <td>1</td> <td>0</td> </tr> <tr> <td><b>Access</b></td> <td>r</td> <td>r</td> <td>r</td> <td>r</td> <td>r</td> <td>r</td> <td>r</td> <td>r</td> </tr> <tr> <td><b>Function</b></td> <td colspan="4">Exponent</td> <td colspan="4">Mantissa</td> </tr> <tr> <td><b>Default Value</b></td> <td>1</td> <td>1</td> <td>1</td> <td>0</td> <td>0</td> <td>0</td> <td>0</td> <td>0</td> </tr> <tr> <td><b>Bit Position</b></td> <td>7</td> <td>6</td> <td>5</td> <td>4</td> <td>3</td> <td>2</td> <td>1</td> <td>0</td> </tr> <tr> <td><b>Access</b></td> <td>r</td> <td>r</td> <td>r</td> <td>r</td> <td>r</td> <td>r</td> <td>r</td> <td>r</td> </tr> <tr> <td><b>Function</b></td> <td colspan="8">Mantissa</td> </tr> <tr> <td><b>Default Value</b></td> <td>0</td> <td>0</td> <td>0</td> <td>0</td> <td>0</td> <td>0</td> <td>0</td> <td>0</td> </tr> </table>	<b>Format</b>	Linear, two's complement binary								<b>Bit Position</b>	7	6	5	4	3	2	1	0	<b>Access</b>	r	r	r	r	r	r	r	r	<b>Function</b>	Exponent				Mantissa				<b>Default Value</b>	1	1	1	0	0	0	0	0	<b>Bit Position</b>	7	6	5	4	3	2	1	0	<b>Access</b>	r	r	r	r	r	r	r	r	<b>Function</b>	Mantissa								<b>Default Value</b>	0	0	0	0	0	0	0	0	
<b>Format</b>	Linear, two's complement binary																																																																																			
<b>Bit Position</b>	7	6	5	4	3	2	1	0																																																																												
<b>Access</b>	r	r	r	r	r	r	r	r																																																																												
<b>Function</b>	Exponent				Mantissa																																																																															
<b>Default Value</b>	1	1	1	0	0	0	0	0																																																																												
<b>Bit Position</b>	7	6	5	4	3	2	1	0																																																																												
<b>Access</b>	r	r	r	r	r	r	r	r																																																																												
<b>Function</b>	Mantissa																																																																																			
<b>Default Value</b>	0	0	0	0	0	0	0	0																																																																												
98	PMBUS_REVISION	<p>Returns one byte indicating the module is compliant to PMBus Spec. 1.1 (read only)</p> <table border="1"> <tr> <td><b>Format</b></td> <td colspan="8">Unsigned Binary</td> </tr> <tr> <td><b>Bit Position</b></td> <td>7</td> <td>6</td> <td>5</td> <td>4</td> <td>3</td> <td>2</td> <td>1</td> <td>0</td> </tr> <tr> <td><b>Access</b></td> <td>r</td> <td>r</td> <td>r</td> <td>r</td> <td>r</td> <td>r</td> <td>r</td> <td>r</td> </tr> <tr> <td><b>Default Value</b></td> <td>0</td> <td>0</td> <td>0</td> <td>1</td> <td>0</td> <td>0</td> <td>0</td> <td>1</td> </tr> </table>	<b>Format</b>	Unsigned Binary								<b>Bit Position</b>	7	6	5	4	3	2	1	0	<b>Access</b>	r	r	r	r	r	r	r	r	<b>Default Value</b>	0	0	0	1	0	0	0	1	YES																																													
<b>Format</b>	Unsigned Binary																																																																																			
<b>Bit Position</b>	7	6	5	4	3	2	1	0																																																																												
<b>Access</b>	r	r	r	r	r	r	r	r																																																																												
<b>Default Value</b>	0	0	0	1	0	0	0	1																																																																												
A0	MFR_VIN_MIN	<p>Returns the minimum input voltage the module is specified to operate at (read only)</p> <table border="1"> <tr> <td><b>Format</b></td> <td colspan="8">Linear, two's complement binary</td> </tr> <tr> <td><b>Bit Position</b></td> <td>7</td> <td>6</td> <td>5</td> <td>4</td> <td>3</td> <td>2</td> <td>1</td> <td>0</td> </tr> <tr> <td><b>Access</b></td> <td>r</td> <td>r</td> <td>r</td> <td>r</td> <td>r</td> <td>r</td> <td>r</td> <td>r</td> </tr> <tr> <td><b>Function</b></td> <td colspan="4">Exponent</td> <td colspan="4">Mantissa</td> </tr> <tr> <td><b>Default Value</b></td> <td>1</td> <td>1</td> <td>1</td> <td>1</td> <td>0</td> <td>0</td> <td>0</td> <td>0</td> </tr> <tr> <td><b>Bit Position</b></td> <td>7</td> <td>6</td> <td>5</td> <td>4</td> <td>3</td> <td>2</td> <td>1</td> <td>0</td> </tr> <tr> <td><b>Access</b></td> <td>r</td> <td>r</td> <td>r</td> <td>r</td> <td>r</td> <td>r</td> <td>r</td> <td>r</td> </tr> <tr> <td><b>Function</b></td> <td colspan="8">Mantissa</td> </tr> <tr> <td><b>Default Value</b></td> <td>0</td> <td>0</td> <td>0</td> <td>0</td> <td>1</td> <td>1</td> <td>0</td> <td>0</td> </tr> </table>	<b>Format</b>	Linear, two's complement binary								<b>Bit Position</b>	7	6	5	4	3	2	1	0	<b>Access</b>	r	r	r	r	r	r	r	r	<b>Function</b>	Exponent				Mantissa				<b>Default Value</b>	1	1	1	1	0	0	0	0	<b>Bit Position</b>	7	6	5	4	3	2	1	0	<b>Access</b>	r	r	r	r	r	r	r	r	<b>Function</b>	Mantissa								<b>Default Value</b>	0	0	0	0	1	1	0	0	YES
<b>Format</b>	Linear, two's complement binary																																																																																			
<b>Bit Position</b>	7	6	5	4	3	2	1	0																																																																												
<b>Access</b>	r	r	r	r	r	r	r	r																																																																												
<b>Function</b>	Exponent				Mantissa																																																																															
<b>Default Value</b>	1	1	1	1	0	0	0	0																																																																												
<b>Bit Position</b>	7	6	5	4	3	2	1	0																																																																												
<b>Access</b>	r	r	r	r	r	r	r	r																																																																												
<b>Function</b>	Mantissa																																																																																			
<b>Default Value</b>	0	0	0	0	1	1	0	0																																																																												
A4	MFR_VOUT_MIN	<p>Returns the minimum output voltage possible from the module (read only)</p> <table border="1"> <tr> <td><b>Format</b></td> <td colspan="8">Linear, two's complement binary</td> </tr> <tr> <td><b>Bit Position</b></td> <td>7</td> <td>6</td> <td>5</td> <td>4</td> <td>3</td> <td>2</td> <td>1</td> <td>0</td> </tr> <tr> <td><b>Access</b></td> <td>r</td> <td>r</td> <td>r</td> <td>r</td> <td>r</td> <td>r</td> <td>r</td> <td>r</td> </tr> <tr> <td><b>Function</b></td> <td colspan="4">Exponent</td> <td colspan="4">Mantissa</td> </tr> <tr> <td><b>Default Value</b></td> <td>0</td> <td>0</td> <td>0</td> <td>0</td> <td>0</td> <td>0</td> <td>1</td> <td>0</td> </tr> <tr> <td><b>Bit Position</b></td> <td>7</td> <td>6</td> <td>5</td> <td>4</td> <td>3</td> <td>2</td> <td>1</td> <td>0</td> </tr> <tr> <td><b>Access</b></td> <td>r</td> <td>r</td> <td>r</td> <td>r</td> <td>r</td> <td>r</td> <td>r</td> <td>r</td> </tr> <tr> <td><b>Function</b></td> <td colspan="8">Mantissa</td> </tr> <tr> <td><b>Default Value</b></td> <td>0</td> <td>1</td> <td>1</td> <td>0</td> <td>0</td> <td>1</td> <td>1</td> <td>0</td> </tr> </table>	<b>Format</b>	Linear, two's complement binary								<b>Bit Position</b>	7	6	5	4	3	2	1	0	<b>Access</b>	r	r	r	r	r	r	r	r	<b>Function</b>	Exponent				Mantissa				<b>Default Value</b>	0	0	0	0	0	0	1	0	<b>Bit Position</b>	7	6	5	4	3	2	1	0	<b>Access</b>	r	r	r	r	r	r	r	r	<b>Function</b>	Mantissa								<b>Default Value</b>	0	1	1	0	0	1	1	0	YES
<b>Format</b>	Linear, two's complement binary																																																																																			
<b>Bit Position</b>	7	6	5	4	3	2	1	0																																																																												
<b>Access</b>	r	r	r	r	r	r	r	r																																																																												
<b>Function</b>	Exponent				Mantissa																																																																															
<b>Default Value</b>	0	0	0	0	0	0	1	0																																																																												
<b>Bit Position</b>	7	6	5	4	3	2	1	0																																																																												
<b>Access</b>	r	r	r	r	r	r	r	r																																																																												
<b>Function</b>	Mantissa																																																																																			
<b>Default Value</b>	0	1	1	0	0	1	1	0																																																																												
D0	MFR_SPECIFIC_00	<p>Returns module name information (read only)</p> <table border="1"> <tr> <td><b>Format</b></td> <td colspan="8">Unsigned Binary</td> </tr> <tr> <td><b>Bit Position</b></td> <td>7</td> <td>6</td> <td>5</td> <td>4</td> <td>3</td> <td>2</td> <td>1</td> <td>0</td> </tr> <tr> <td><b>Access</b></td> <td>r</td> <td>r</td> <td>r</td> <td>r</td> <td>r</td> <td>r</td> <td>r</td> <td>r</td> </tr> <tr> <td><b>Function</b></td> <td colspan="8">Reserved</td> </tr> <tr> <td><b>Default Value</b></td> <td>0</td> <td>0</td> <td>0</td> <td>0</td> <td>0</td> <td>0</td> <td>0</td> <td>0</td> </tr> <tr> <td><b>Bit Position</b></td> <td>7</td> <td>6</td> <td>5</td> <td>4</td> <td>3</td> <td>2</td> <td>1</td> <td>0</td> </tr> <tr> <td><b>Access</b></td> <td>r</td> <td>r</td> <td>r</td> <td>r</td> <td>r</td> <td>r</td> <td>r</td> <td>r</td> </tr> <tr> <td><b>Function</b></td> <td colspan="6">Module Name</td> <td colspan="2">Reserved</td> </tr> <tr> <td><b>Default Value</b></td> <td>0</td> <td>0</td> <td>0</td> <td>1</td> <td>1</td> <td>0</td> <td>1</td> <td>0</td> </tr> </table>	<b>Format</b>	Unsigned Binary								<b>Bit Position</b>	7	6	5	4	3	2	1	0	<b>Access</b>	r	r	r	r	r	r	r	r	<b>Function</b>	Reserved								<b>Default Value</b>	0	0	0	0	0	0	0	0	<b>Bit Position</b>	7	6	5	4	3	2	1	0	<b>Access</b>	r	r	r	r	r	r	r	r	<b>Function</b>	Module Name						Reserved		<b>Default Value</b>	0	0	0	1	1	0	1	0	YES
<b>Format</b>	Unsigned Binary																																																																																			
<b>Bit Position</b>	7	6	5	4	3	2	1	0																																																																												
<b>Access</b>	r	r	r	r	r	r	r	r																																																																												
<b>Function</b>	Reserved																																																																																			
<b>Default Value</b>	0	0	0	0	0	0	0	0																																																																												
<b>Bit Position</b>	7	6	5	4	3	2	1	0																																																																												
<b>Access</b>	r	r	r	r	r	r	r	r																																																																												
<b>Function</b>	Module Name						Reserved																																																																													
<b>Default Value</b>	0	0	0	1	1	0	1	0																																																																												

Hex Code	Command	Brief Description	Non-Volatile Memory Storage																																																																																	
D4	VOUT_CAL_OFFSET	<p>Applies an offset to the READ_VOUT command results to calibrate out offset errors in module measurements of the output voltage (between -125mV and +124mV)</p> <table border="1"> <tr> <td><b>Format</b></td> <td colspan="8">Linear, two's complement binary</td> </tr> <tr> <td><b>Bit Position</b></td> <td>7</td><td>6</td><td>5</td><td>4</td><td>3</td><td>2</td><td>1</td><td>0</td> </tr> <tr> <td><b>Access</b></td> <td>r/w</td><td>r</td><td>r</td><td>r</td><td>r</td><td>r</td><td>r</td><td>r</td> </tr> <tr> <td><b>Function</b></td> <td colspan="8">Mantissa</td> </tr> <tr> <td><b>Default Value</b></td> <td>V</td><td>0</td><td>0</td><td>0</td><td>0</td><td>0</td><td>0</td><td>0</td> </tr> <tr> <td><b>Bit Position</b></td> <td>7</td><td>6</td><td>5</td><td>4</td><td>3</td><td>2</td><td>1</td><td>0</td> </tr> <tr> <td><b>Access</b></td> <td>r</td><td>r/w</td><td>r/w</td><td>r/w</td><td>r/w</td><td>r/w</td><td>r/w</td><td>r/w</td> </tr> <tr> <td><b>Function</b></td> <td colspan="8">Mantissa</td> </tr> <tr> <td><b>Default Value</b></td> <td>V</td><td>V</td><td>V</td><td>V</td><td>V</td><td>V</td><td>V</td><td>V</td> </tr> </table>	<b>Format</b>	Linear, two's complement binary								<b>Bit Position</b>	7	6	5	4	3	2	1	0	<b>Access</b>	r/w	r	r	r	r	r	r	r	<b>Function</b>	Mantissa								<b>Default Value</b>	V	0	0	0	0	0	0	0	<b>Bit Position</b>	7	6	5	4	3	2	1	0	<b>Access</b>	r	r/w	r/w	r/w	r/w	r/w	r/w	r/w	<b>Function</b>	Mantissa								<b>Default Value</b>	V	V	V	V	V	V	V	V	YES
<b>Format</b>	Linear, two's complement binary																																																																																			
<b>Bit Position</b>	7	6	5	4	3	2	1	0																																																																												
<b>Access</b>	r/w	r	r	r	r	r	r	r																																																																												
<b>Function</b>	Mantissa																																																																																			
<b>Default Value</b>	V	0	0	0	0	0	0	0																																																																												
<b>Bit Position</b>	7	6	5	4	3	2	1	0																																																																												
<b>Access</b>	r	r/w	r/w	r/w	r/w	r/w	r/w	r/w																																																																												
<b>Function</b>	Mantissa																																																																																			
<b>Default Value</b>	V	V	V	V	V	V	V	V																																																																												
D5	VOUT_CAL_GAIN	<p>Applies a gain correction to the READ_VOUT command results to calibrate out gain errors in module measurements of the output voltage (between -0.125 and 0.121)</p> <table border="1"> <tr> <td><b>Format</b></td> <td colspan="8">Linear, two's complement binary</td> </tr> <tr> <td><b>Bit Position</b></td> <td>7</td><td>6</td><td>5</td><td>4</td><td>3</td><td>2</td><td>1</td><td>0</td> </tr> <tr> <td><b>Access</b></td> <td>r</td><td>r</td><td>r</td><td>r</td><td>r</td><td>r/w</td><td>r</td><td>r</td> </tr> <tr> <td><b>Function</b></td> <td colspan="4">Exponent</td> <td colspan="4">Mantissa</td> </tr> <tr> <td><b>Default Value</b></td> <td>1</td><td>1</td><td>0</td><td>0</td><td>0</td><td>0</td><td>0</td><td>V</td> </tr> <tr> <td><b>Bit Position</b></td> <td>7</td><td>6</td><td>5</td><td>4</td><td>3</td><td>2</td><td>1</td><td>0</td> </tr> <tr> <td><b>Access</b></td> <td>r</td><td>r</td><td>r</td><td>r/w</td><td>r/w</td><td>r/w</td><td>r/w</td><td>r/w</td> </tr> <tr> <td><b>Function</b></td> <td colspan="8">Mantissa</td> </tr> <tr> <td><b>Default Value</b></td> <td>V</td><td>V</td><td>V</td><td>V</td><td>V</td><td>V</td><td>V</td><td>V</td> </tr> </table>	<b>Format</b>	Linear, two's complement binary								<b>Bit Position</b>	7	6	5	4	3	2	1	0	<b>Access</b>	r	r	r	r	r	r/w	r	r	<b>Function</b>	Exponent				Mantissa				<b>Default Value</b>	1	1	0	0	0	0	0	V	<b>Bit Position</b>	7	6	5	4	3	2	1	0	<b>Access</b>	r	r	r	r/w	r/w	r/w	r/w	r/w	<b>Function</b>	Mantissa								<b>Default Value</b>	V	V	V	V	V	V	V	V	YES
<b>Format</b>	Linear, two's complement binary																																																																																			
<b>Bit Position</b>	7	6	5	4	3	2	1	0																																																																												
<b>Access</b>	r	r	r	r	r	r/w	r	r																																																																												
<b>Function</b>	Exponent				Mantissa																																																																															
<b>Default Value</b>	1	1	0	0	0	0	0	V																																																																												
<b>Bit Position</b>	7	6	5	4	3	2	1	0																																																																												
<b>Access</b>	r	r	r	r/w	r/w	r/w	r/w	r/w																																																																												
<b>Function</b>	Mantissa																																																																																			
<b>Default Value</b>	V	V	V	V	V	V	V	V																																																																												
D6	VIN_CAL_OFFSET	<p>Applies an offset correction to the READ_VIN command results to calibrate out offset errors in module measurements of the input voltage (between -2V and +1.968V)</p> <table border="1"> <tr> <td><b>Format</b></td> <td colspan="8">Linear, two's complement binary</td> </tr> <tr> <td><b>Bit Position</b></td> <td>7</td><td>6</td><td>5</td><td>4</td><td>3</td><td>2</td><td>1</td><td>0</td> </tr> <tr> <td><b>Access</b></td> <td>r</td><td>r</td><td>r</td><td>r</td><td>r</td><td>r/w</td><td>r</td><td>r</td> </tr> <tr> <td><b>Function</b></td> <td colspan="4">Exponent</td> <td colspan="4">Mantissa</td> </tr> <tr> <td><b>Default Value</b></td> <td>1</td><td>1</td><td>0</td><td>1</td><td>V</td><td>0</td><td>0</td><td>V</td> </tr> <tr> <td><b>Bit Position</b></td> <td>7</td><td>6</td><td>5</td><td>4</td><td>3</td><td>2</td><td>1</td><td>0</td> </tr> <tr> <td><b>Access</b></td> <td>r</td><td>r</td><td>r/w</td><td>r/w</td><td>r/w</td><td>r/w</td><td>r/w</td><td>r/w</td> </tr> <tr> <td><b>Function</b></td> <td colspan="8">Mantissa</td> </tr> <tr> <td><b>Default Value</b></td> <td>0</td><td>0</td><td>V</td><td>V</td><td>V</td><td>V</td><td>V</td><td>V</td> </tr> </table>	<b>Format</b>	Linear, two's complement binary								<b>Bit Position</b>	7	6	5	4	3	2	1	0	<b>Access</b>	r	r	r	r	r	r/w	r	r	<b>Function</b>	Exponent				Mantissa				<b>Default Value</b>	1	1	0	1	V	0	0	V	<b>Bit Position</b>	7	6	5	4	3	2	1	0	<b>Access</b>	r	r	r/w	r/w	r/w	r/w	r/w	r/w	<b>Function</b>	Mantissa								<b>Default Value</b>	0	0	V	V	V	V	V	V	YES
<b>Format</b>	Linear, two's complement binary																																																																																			
<b>Bit Position</b>	7	6	5	4	3	2	1	0																																																																												
<b>Access</b>	r	r	r	r	r	r/w	r	r																																																																												
<b>Function</b>	Exponent				Mantissa																																																																															
<b>Default Value</b>	1	1	0	1	V	0	0	V																																																																												
<b>Bit Position</b>	7	6	5	4	3	2	1	0																																																																												
<b>Access</b>	r	r	r/w	r/w	r/w	r/w	r/w	r/w																																																																												
<b>Function</b>	Mantissa																																																																																			
<b>Default Value</b>	0	0	V	V	V	V	V	V																																																																												
D7	VIN_CAL_GAIN	<p>Applies a gain correction to the READ_VIN command results to calibrate out gain errors in module measurements of the input voltage (between -0.125 and 0.121)</p> <table border="1"> <tr> <td><b>Format</b></td> <td colspan="8">Linear, two's complement binary</td> </tr> <tr> <td><b>Bit Position</b></td> <td>7</td><td>6</td><td>5</td><td>4</td><td>3</td><td>2</td><td>1</td><td>0</td> </tr> <tr> <td><b>Access</b></td> <td>r</td><td>r</td><td>r</td><td>r</td><td>r</td><td>r/w</td><td>r</td><td>r</td> </tr> <tr> <td><b>Function</b></td> <td colspan="4">Exponent</td> <td colspan="4">Mantissa</td> </tr> <tr> <td><b>Default Value</b></td> <td>1</td><td>1</td><td>0</td><td>0</td><td>V</td><td>0</td><td>0</td><td>V</td> </tr> <tr> <td><b>Bit Position</b></td> <td>7</td><td>6</td><td>5</td><td>4</td><td>3</td><td>2</td><td>1</td><td>0</td> </tr> <tr> <td><b>Access</b></td> <td>r</td><td>r</td><td>r</td><td>r/w</td><td>r/w</td><td>r/w</td><td>r/w</td><td>r/w</td> </tr> <tr> <td><b>Function</b></td> <td colspan="8">Mantissa</td> </tr> <tr> <td><b>Default Value</b></td> <td>0</td><td>0</td><td>0</td><td>V</td><td>V</td><td>V</td><td>V</td><td>V</td> </tr> </table>	<b>Format</b>	Linear, two's complement binary								<b>Bit Position</b>	7	6	5	4	3	2	1	0	<b>Access</b>	r	r	r	r	r	r/w	r	r	<b>Function</b>	Exponent				Mantissa				<b>Default Value</b>	1	1	0	0	V	0	0	V	<b>Bit Position</b>	7	6	5	4	3	2	1	0	<b>Access</b>	r	r	r	r/w	r/w	r/w	r/w	r/w	<b>Function</b>	Mantissa								<b>Default Value</b>	0	0	0	V	V	V	V	V	YES
<b>Format</b>	Linear, two's complement binary																																																																																			
<b>Bit Position</b>	7	6	5	4	3	2	1	0																																																																												
<b>Access</b>	r	r	r	r	r	r/w	r	r																																																																												
<b>Function</b>	Exponent				Mantissa																																																																															
<b>Default Value</b>	1	1	0	0	V	0	0	V																																																																												
<b>Bit Position</b>	7	6	5	4	3	2	1	0																																																																												
<b>Access</b>	r	r	r	r/w	r/w	r/w	r/w	r/w																																																																												
<b>Function</b>	Mantissa																																																																																			
<b>Default Value</b>	0	0	0	V	V	V	V	V																																																																												

**56. THERMAL CONSIDERATIONS**

The SLDN-06D1Ax power modules operate in a variety of thermal environments; however, sufficient cooling should always be provided to help ensure reliable operation.

Considerations include ambient temperature, airflow, module power dissipation, and the need for increased reliability. A reduction in the operating temperature of the module will result in an increase in reliability. The thermal data presented here is based on physical measurements taken in a wind tunnel. The test set-up is shown in Figure 49. The preferred airflow direction for the module is in Figure 50.

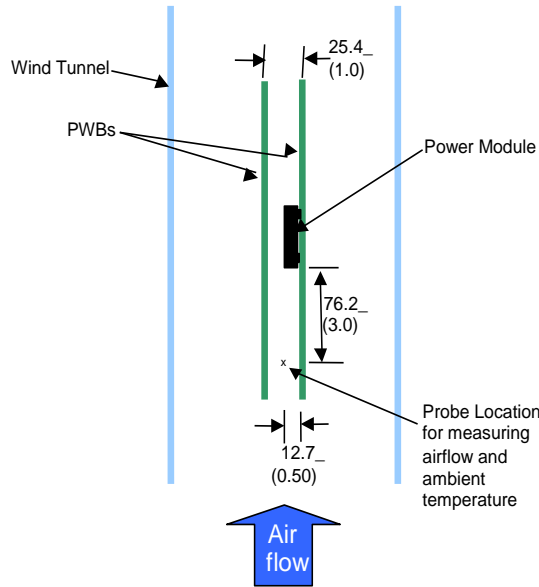

Figure 49. Thermal Test Setup

The thermal reference points, Tref used in the specifications are also shown in Figure 50. For reliable operation the temperatures at these points should not exceed 120°C. The output power of the module should not exceed the rated power of the module (Vo, set x Io, max)

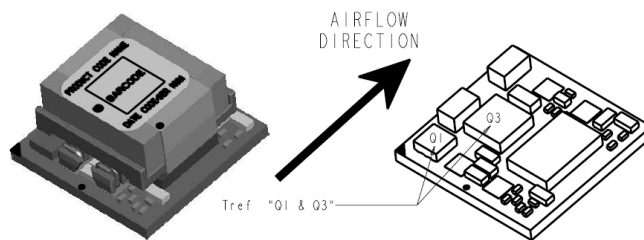

Figure 50.

Preferred airflow direction and location of hot spot of the module (Tref)

## 57. EXAMPLE APPLICATION CIRCUIT

### Requirements:

Vin:	12 V
Vout:	1.8 V
Iout:	4.5 A max., worst case load transient is from 3 to 4.5 A
$\Delta V_{out}$ :	1.5% of Vout (27 mV) for worst case load transient
Vin, ripple	1.5% of Vin (50 mV, p-p)

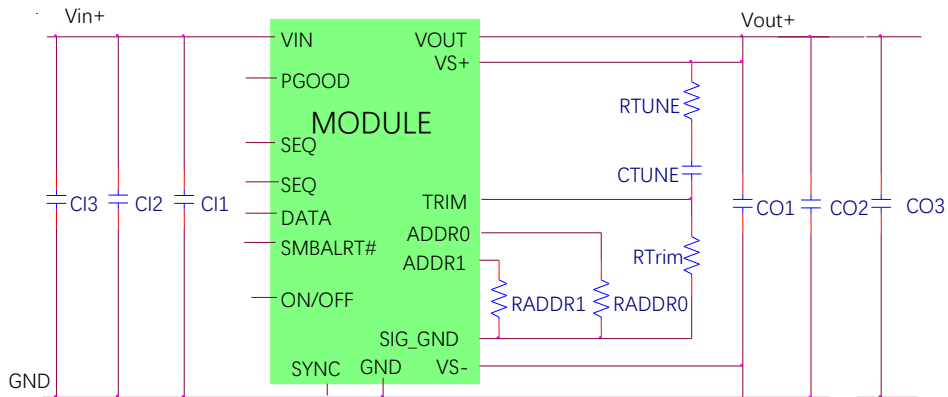

Figure 51.

CI1	Decoupling cap - 1x0.047 $\mu$ F/16 V ceramic capacitor (e.g. Murata LLL185R71C473MA01)
CI2	1x22 $\mu$ F/16 V ceramic capacitor (e.g. Murata GRM32ER61C226KE20)
CI3	470 $\mu$ F/16 V bulk electrolytic
CO1	Decoupling cap - 1x0.047 $\mu$ F/16 V ceramic capacitor (e.g. Murata LLL185R71C473MA01)
CO2	1 x 47 $\mu$ F/6.3 V ceramic capacitor (e.g. Murata GRM31CR60J476ME19)
CO3	1 x 330 $\mu$ F/6.3 V Polymer (e.g. Sanyo Poscap)
CTune	2200 pF ceramic capacitor (can be 1206, 0805 or 0603 size)
RTune	178 $\Omega$ SMT resistor (can be 1206, 0805 or 0603 size)
RTrim	10 k $\Omega$ SMT resistor (can be 1206, 0805 or 0603 size, recommended tolerance of 0.1%)

**Note:** The DATA, CLK and SMBALRT pins do not have any pull-up resistors inside the module. Typically, the SMBus master controller will have the pull-up resistors as well as provide the driving source for these signals.

58. MECHANICAL DIMENSIONS

OUTLINE

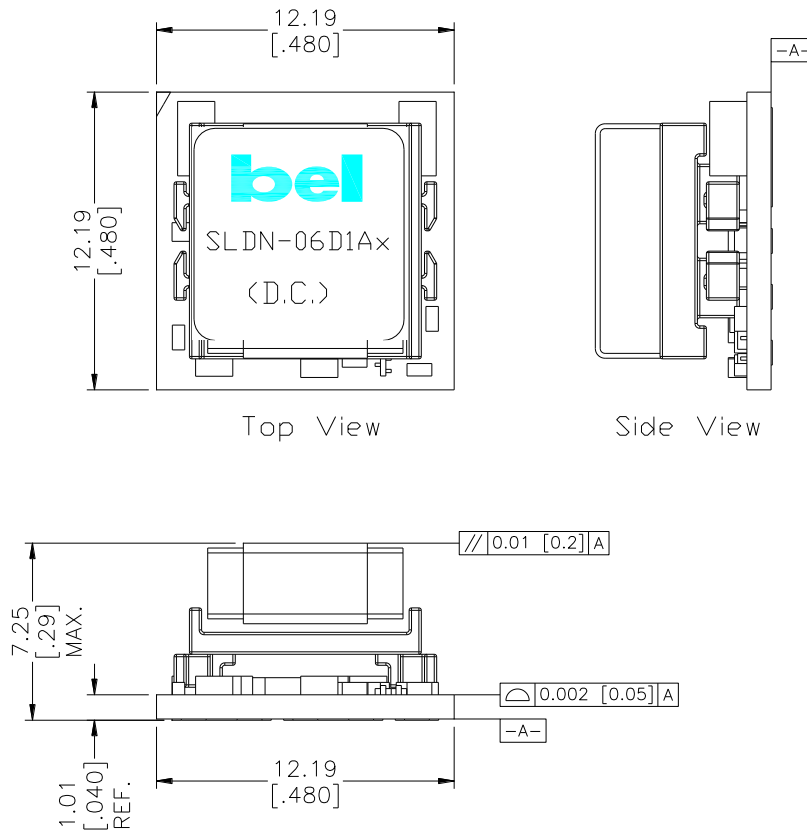

Figure 52.

Dimensions are in mm [inch].

Tolerances: x.x ± 0.5 mm [± 0.02 inch] [unless otherwise indicated].

x.xx ± 0.25 mm [± 0.010 inch].

**Note:** This module is recommended and compatible with Pb-Free Reflow Soldering and must be soldered using a reflow profile with a peak temperature of no more than 260 °C for less than 5 seconds.

**PIN DEFINITIONS**

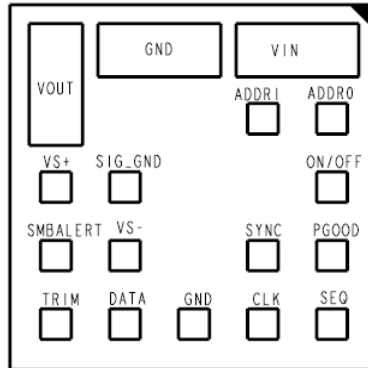

BOTTOM VIEW  
Figure 53. Pins

PIN	FUNCTION	PIN	FUNCTION
1	ON/OFF	10	PGOOD
2	VIN	11	SYNC <sup>1</sup>
3	GND	12	VS-
4	VOUT	13	SIG. GND
5	SENSE	14	SMBALERT
6	TRIM	15	DATA
7	GND	16	ADDR0
8	CLK	17	ADDR1
9	SEQ		

**RECOMMENDED PAD LAYOUT**

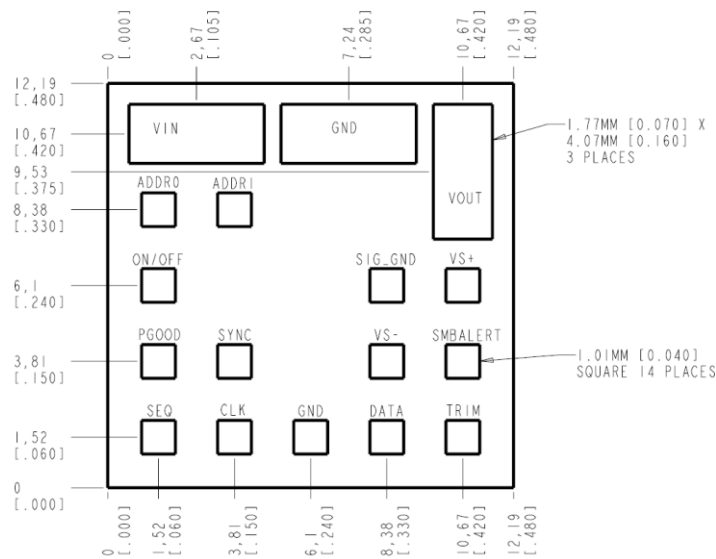

RECOMMENDED FOOTPRINT  
- THROUGH THE BOARD -

Figure 54. Recommended pad layout



**Asia-Pacific**  
+86 755 298 85888

**Europe, Middle East**  
+353 61 49 8941

**North America**  
+1 866 513 2839

**59. PACKAGING DETAILS**

The SLDN-06D1Ax modules are supplied in tape & reel as standard.

All Dimensions are in mm [inch].

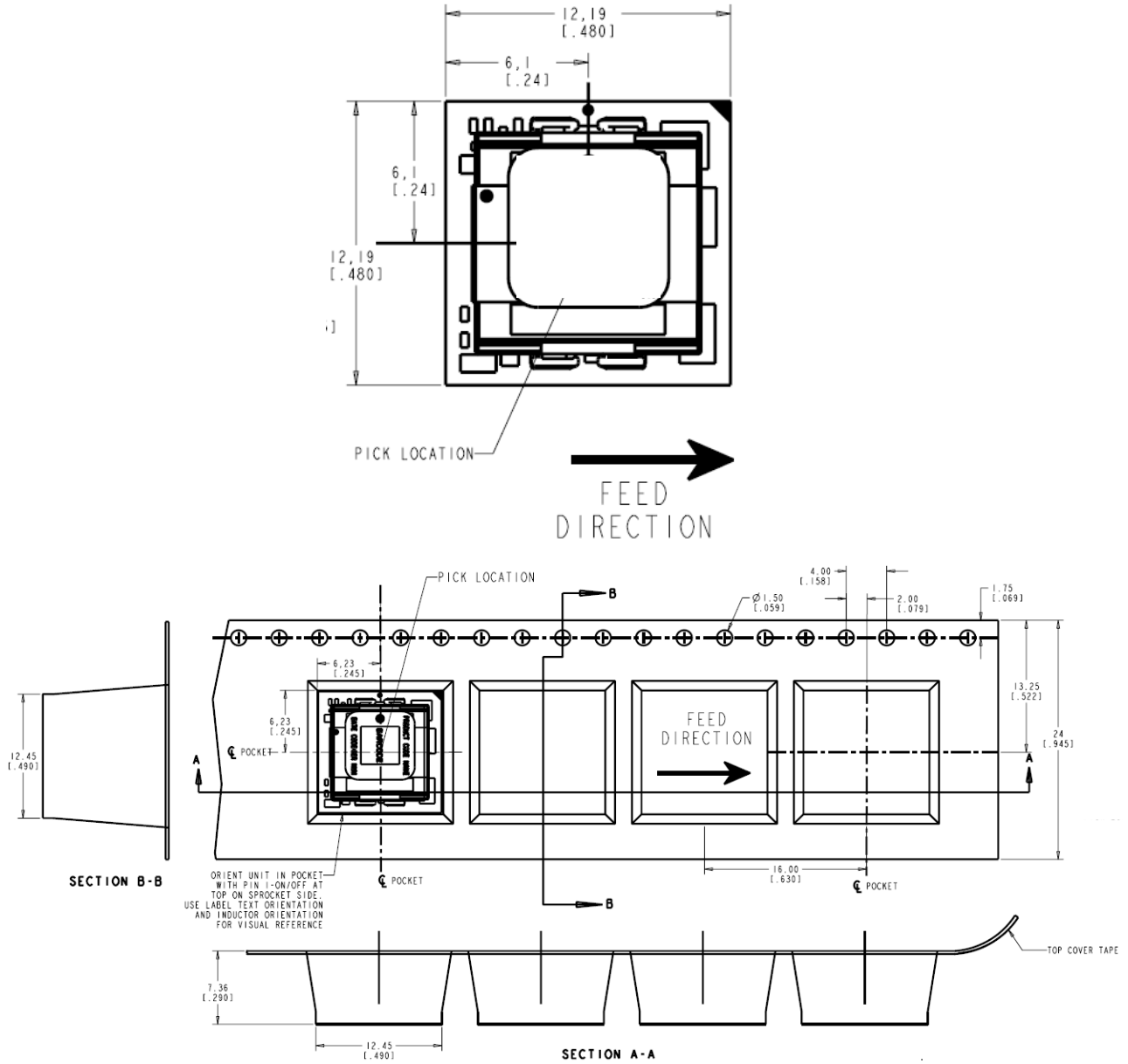

Figure 55.

- Reel Dimensions:
- Outside Dimensions: 330.2 mm [13.00 inch]
- Inside Dimensions: 177.8 mm [7.00 inch]
- Tape Width: 24.00 mm [0.945 inch]



## 60. SURFACE MOUNT INFORMATION

### Pick and Place

The SLDN-06D1Ax modules use an open frame construction and are designed for a fully automated assembly process. The modules are fitted with a label designed to provide a large surface area for pick and place operations. The label meets all the requirements for surface mount processing, as well as safety standards, and is able to withstand reflow temperatures of up to 300°C. The label also carries product information such as product code, serial number and the location of manufacture.

### Nozzle Recommendations

The module weight has been kept to a minimum by using open frame construction. Variables such as nozzle size, tip style, vacuum pressure and placement speed should be considered to optimize this process. The minimum recommended inside nozzle diameter for reliable operation is 3mm. The maximum nozzle outer diameter, which will safely fit within the allowable component spacing, is 7 mm.

### Bottom Side / First Side Assembly

This SLDN-06D1Ax module is not recommended for assembly on the bottom side of a customer board. If such an assembly is attempted, components may fall off the module during the second reflow process.

### Lead Free Soldering

The SLDN-06D1Ax modules are lead-free (Pb-free) and RoHS compliant and are both forward and backward compatible in a Pb-free and a SnPb soldering process. Failure to observe the instructions below may result in the failure of or cause damage to the modules and can adversely affect long-term reliability.

### Pb-free Reflow Profile

Power Systems will comply with J-STD-020 Rev. C (Moisture/Reflow Sensitivity Classification for Nonhermetic Solid State Surface Mount Devices) for both Pb-free solder profiles and MSL classification procedures. This standard provides a recommended forced-air-convection reflow profile based on the volume and thickness of the package (table 5-2). The suggested Pb-free solder paste is Sn/Ag/Cu (SAC). The recommended linear reflow profile using Sn/Ag/Cu solder is shown in Fig. 56. Soldering outside of the recommended profile requires testing to verify results and performance.

It is recommended that the pad layout include a test pad where the output pin is in the ground plane. The thermocouple should be attached to this test pad since this will be the coolest solder joints. The temperature of this point should be:

Maximum peak temperature is 260 °C.

Minimum temperature is 235 °C.

Dwell time above 217 °C: 60 seconds minimum Dwell time above 235 °C: 5 to 15 second.

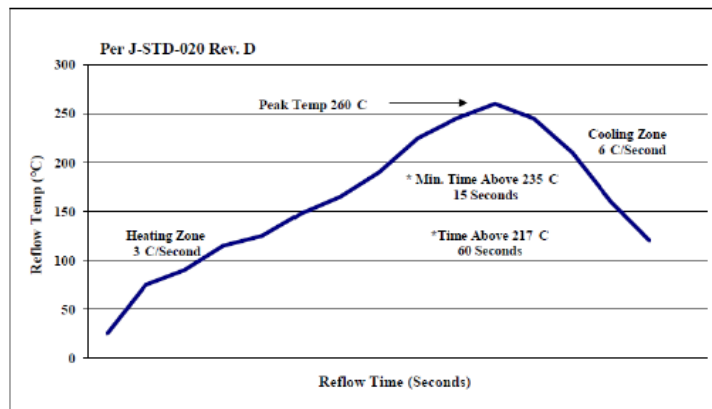

Figure 56. Recommended linear reflow profile using Sn/Ag/Cu solder



<b>Asia-Pacific</b>	<b>Europe, Middle East</b>	<b>North America</b>
+86 755 298 85888	+353 61 49 8941	+1 866 513 2839

**MSL Rating**

The SLDN-06D1Ax modules have a MSL rating of 2 A.

**Storage and Handling**

The recommended storage environment and handling procedures for moisture-sensitive surface mount packages is detailed in J-STD-033 Rev. B (Handling, Packing, Shipping and Use of Moisture/Reflow Sensitive Surface Mount Devices). Moisture barrier bags (MBB) with desiccant are required for MSL ratings of 2 or greater. These sealed packages should not be broken until time of use. Once the original package is broken, the floor life of the product at conditions of  $\leq 30^{\circ}\text{C}$  and 60% relative humidity varies according to the MSL rating (see J-STD-033A). The shelf life for dry packed SMT packages will be a minimum of 12 months from the bag seal date, when stored at the following conditions:  $< 40^{\circ}\text{C}$ ,  $< 90\%$  relative humidity.

**Post Solder Cleaning and Drying Considerations**

Post solder cleaning is usually the final circuit-board assembly process prior to electrical board testing. The result of inadequate cleaning and drying can affect both the reliability of a power module and the testability of the finished circuit-board assembly. For guidance on appropriate soldering, cleaning and drying procedures, refer to Board Mounted Power Modules: Soldering and Cleaning Application Note (AN04-001).

## 61. REVISION HISTORY

DATE	REVISION	CHANGES DETAIL	APPROVAL
2012-03-20	A	First release.	HL.Lu
2012-05-09	B	Adding patent info.	HL.Lu
2015-07-02	C	Update part selection, output specifications, general specifications, safety considerations, analog voltage margining, output voltage adjustment using the POWER MANAGEMENT BUS, POWER MANAGEMENT BUS adjustable overcurrent warning, POWER MANAGEMENT BUS adjustable input undervoltage lockout, measuring output current using the POWER MANAGEMENT BUS, summary of supported POWER MANAGEMENT BUS commands, thermal considerations, example application circuit, packaging details, MSL rating.	XF.Jiang
2017-05-31	AD	Update the version.	HL.Lu
2021-08-12	AE	Add object ID. Update safety certificate and altitude.	XF.Jiang

For more information on these products consult: [tech.support@psbel.com](mailto:tech.support@psbel.com)

**NUCLEAR AND MEDICAL APPLICATIONS** - Products are not designed or intended for use as critical components in life support systems, equipment used in hazardous environments, or nuclear control systems.

**TECHNICAL REVISIONS** - The appearance of products, including safety agency certifications pictured on labels, may change depending on the date manufactured. Specifications are subject to change without notice.



<b>Asia-Pacific</b>	<b>Europe, Middle East</b>	<b>North America</b>
+86 755 298 85888	+353 61 49 8941	+1 866 513 2839