

Low Cost Passive Input RS-485 and RS-422 Isolated Transceivers

Functional Diagrams

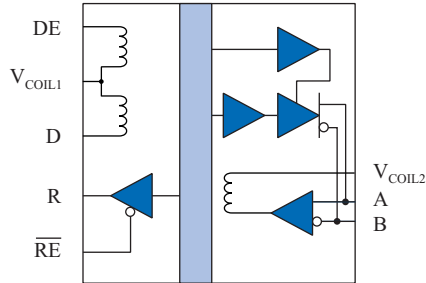

IL3185

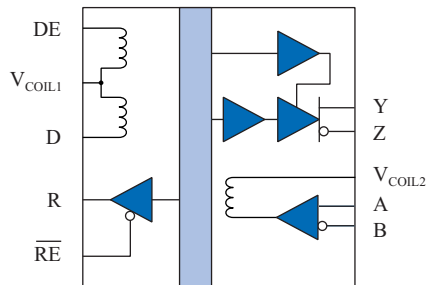

IL3122

Features

- 5 Mbps data rate
- 3 V to 5 V power supplies
- Supports up to 32 nodes
- 15 kV bus ESD protection
- 20 kV/μs typical common mode rejection
- No carrier or clock for low EMI emissions and susceptibility
- -40 °C to +85 °C temperature range
- Thermal shutdown protection
- 2500 V_{RMS} isolation
- VDE V 0884-11 / IEC 60747-17 certified; UL 1577 recognized
- 0.15" or 0.3" True 8TM mm 16-pin SOIC packages

Applications

- P.O.S. systems
- Security networks
- Building environmental controls
- Industrial control networks
- Gaming systems
- Factory automation

IL3185 Truth Table

| V _{ID} (A-B) | DE | RE-bar | R | D | Mode | Notes |
|-----------------------|----|--------|---|---|----------|----------------------------|
| ≥ 200 mV | L | L | H | X | Receive | |
| ≤ -200mV | L | L | L | X | | |
| Open | L | L | H | X | | A/B failsafe |
| ≥ 1.5 V | H | L | H | H | Drive | R reads back D information |
| ≤ -1.5 V | H | L | L | L | | |
| ≥ 1.5 V | H | H | Z | H | | R tri-state (no output) |
| ≤ -1.5 V | H | H | Z | L | | |
| X | L | H | Z | X | Disabled | R tri-state; A/B failsafe |

Z = High Impedance X = Irrelevant

IL3122 Receiver

| RE-bar | R | V _(A-B) |
|--------|---|--------------------|
| H | Z | X |
| L | H | ≥ 200 mV |
| L | L | ≤ -200 mV |
| L | H | Open |

IL3122 Driver

| DE | D | V _(Y-Z) |
|----|---|--------------------|
| L | X | Z |
| H | H | ≥ 200 mV |
| H | L | ≤ -200 mV |

Selection Table

| Model | Full/Half Duplex | No. of Devices Allowed on Bus | Data Rate Mbps | Fail-Safe |
|--------|------------------|-------------------------------|----------------|-----------|
| IL3185 | half | 32 | 5 | yes |
| IL3122 | full | 32 | 5 | yes |

IsoLoop® is a registered trademark of NVE Corporation.

*U.S. Patent numbers 5,831,426; 6,300,617 and others.

REV. Q

Absolute Maximum Ratings

Operating at absolute maximum ratings will not damage the device. However, extended periods of operation at the absolute maximum ratings may affect performance and reliability.

| Parameters | Symbol | Min. | Typ. | Max. | Units | Test Conditions |
|----------------------------------|--------------------|------|------|--------------|-------|-----------------|
| Storage Temperature | T_S | -55 | | 150 | °C | |
| Junction Temperature | T_J | -55 | | 150 | °C | |
| Voltage Range at A or B Bus Pins | | -7 | | 12 | V | |
| Supply Voltage ⁽¹⁾ | V_{DD1}, V_{DD2} | -0.5 | | 7 | V | |
| Digital Input Voltage | | -0.5 | | $V_{DD}+0.5$ | V | |
| Digital Output Voltage | | -0.5 | | $V_{DD}+1$ | V | |
| ESD Protection | | ±15 | | | kV | |
| Input Current | I_{IN} | -25 | | +25 | mA | |
| ESD (all bus nodes) | | 15 | | | kV | HBM |

Note 1. All voltage values are with respect to network ground except differential I/O bus voltages.

Recommended Operating Conditions

| Parameters | Symbol | Min. | Typ. | Max. | Units | Test Conditions |
|---|------------------------|------------|------|------------|-------|-----------------|
| Supply Voltage | V_{DD1} V_{DD2} | 3.0 4.5 | | 5.5 5.5 | V | |
| Ambient Operating Temperature | T_A | -40 | | 85 | °C | |
| Junction Temperature | T_J | -40 | | 100 | °C | |
| Input Voltage at any Bus Terminal (separately or common mode) | V_I V_{IC} | | | 12 -7 | V | |
| Input Threshold for Output Logic High | I_{INH} | | 1.5 | 0.8 | mA | |
| Input Threshold for Output Logic Low | I_{INL} | 5 | 3.5 | | mA | |
| Differential Input Voltage | V_{ID} | | | +12/-7 | V | |
| High-Level Output Current (Driver) | I_{OH} | -60 | | 60 | mA | |
| High-Level Digital Output Current (Receiver) | I_{OH} | -8 | | 8 | mA | |
| Low-Level Output Current (Driver) | I_{OL} | -60 | | 60 | mA | |
| Low-Level Digital Output Current (Receiver) | I_{OL} | -8 | | 8 | mA | |
| Digital Input Signal Rise, Fall Times | t_{IR}, t_{IF} | | | 1 | µs | |

Safety Approvals

VDE V 0884-11 / IEC 60747-17 (Basic Isolation; VDE File Number 5016933-4880-0001)

- Isolation voltage (V_{ISO}): 2500 V_{RMS}
- Transient overvoltage (V_{IOTM}): 4000 V_{PK}
- Surge rating: 4000 V_{PK}
- Each part tested at 1590 V_{PK} for 1 second, 5 pC partial discharge limit.
- Samples tested at 4000 V_{PK} for 60 sec.; then 1358 V_{PK} for 10 sec. with 5 pC partial discharge limit.
- Working Voltage (V_{IORM} ; pollution degree 2): 600 V_{RMS}

| Safety-Limiting Values | Symbol | Value | Units |
|--|--------|-------|-------------|
| Safety rating ambient temperature | T_S | 180 | $^{\circ}C$ |
| Safety rating power (180 $^{\circ}C$) | P_S | 270 | mW |
| Supply current safety rating (total of supplies) | I_S | 54 | mA |

UL 1577 (Component Recognition Program File Number E207481)

- 2500 V rating
- Each part tested at 3000 V_{RMS} (4243 V_{PK}) for 1 second
- Each lot sample tested at 2500 V_{RMS} (3536 V_{PK}) for 1 minute

Soldering Profile

Per JEDEC J-STD-020C, MSL 1

Electrostatic Discharge Sensitivity

This product has been tested for electrostatic sensitivity to the limits stated in the specifications. However, NVE recommends that all integrated circuits be handled with appropriate care to avoid damage. Damage caused by inappropriate handling or storage could range from performance degradation to complete failure.

IL3185-3 Pin Connections (0.15" SOIC Package)

| | | |
|----|------------------------|--|
| 1 | V _{DD1} | Input power supply |
| 2 | GND ₁ | Ground return for V _{DD1} |
| 3 | R | Output data from bus |
| 4 | $\overline{\text{RE}}$ | Read enable (if RE is high, R is high impedance) |
| 5 | DE | Drive enable |
| 6 | V _{COIL1} | Coils for DE and D (connect to V _{DD1}) |
| 7 | D | Data input to bus |
| 8 | DNC | Do not connect |
| 9 | GND ₂ | Ground return for V _{DD2} (internally connected to pin 15) |
| 10 | NC | No internal connection |
| 11 | V _{DD2} | Output power supply |
| 12 | A | Non-inverting bus line |
| 13 | B | Inverting bus line |
| 14 | NC | No internal connection |
| 15 | GND ₂ | Ground return for V _{DD2} (internally connected to pin 9) |
| 16 | V _{COIL2} | Coil for R |

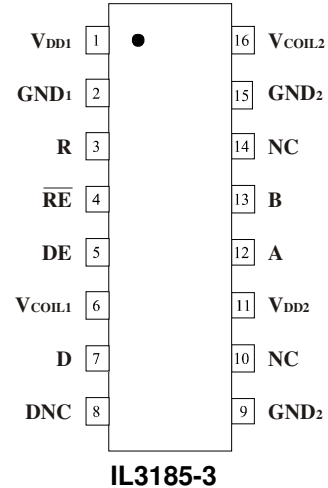

IL3122-3 Pin Connections (0.15" SOIC Package)

| | | |
|----|------------------------|--|
| 1 | V _{DD1} | Input power supply |
| 2 | GND ₁ | Ground return for V _{DD1} |
| 3 | R | Output data from bus |
| 4 | $\overline{\text{RE}}$ | Read enable (if RE is high, R is high impedance) |
| 5 | DE | Drive enable |
| 6 | V _{COIL1} | Coils for DE and D (connect to V _{DD1}) |
| 7 | D | Data input to bus |
| 8 | DNC | Do not connect |
| 9 | GND ₂ | Ground return for V _{DD2} (internally connected to pin 15) |
| 10 | Y | Non-inverting driver bus line |
| 11 | V _{DD2} | Output power supply |
| 12 | Z | Inverting driver bus line |
| 13 | B | Inverting receiver bus line |
| 14 | A | Non-inverting receiver bus line |
| 15 | GND ₂ | Ground return for V _{DD2} (internally connected to pin 9) |
| 16 | V _{COIL2} | Coil for R |

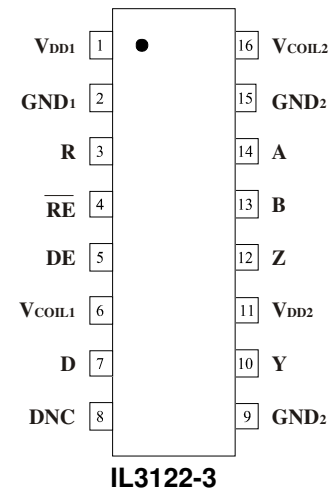

IL3185 Pin Connections (0.3" SOIC Package)

| | | |
|----|------------------------|---|
| 1 | V _{DD1} | Input power supply |
| 2 | GND ₁ | Ground return for V _{DD1} |
| 3 | R | Output data from bus |
| 4 | $\overline{\text{RE}}$ | Read enable (if RE is high, R is high impedance) |
| 5 | DE | Drive enable |
| 6 | V _{COIL1} | Coils for DE and D (connect to V _{DD1}) |
| 7 | D | Data input to bus |
| 8 | GND ₁ | Internally connected to pin 2 for 0.3" package; no internal connection on 0.15" IL3185-3 |
| 9 | GND ₂ | Ground return for V _{DD2} (internally connected to pin 15) |
| 10 | NC | No internal connection |
| 11 | V _{DD2} | Output power supply |
| 12 | A | Non-inverting bus line |
| 13 | B | Inverting bus line |
| 14 | NC | No internal connection |
| 15 | GND ₂ | Ground return for V _{DD2} (internally connected to pin 9) |
| 16 | V _{COIL2} | Coil for R |

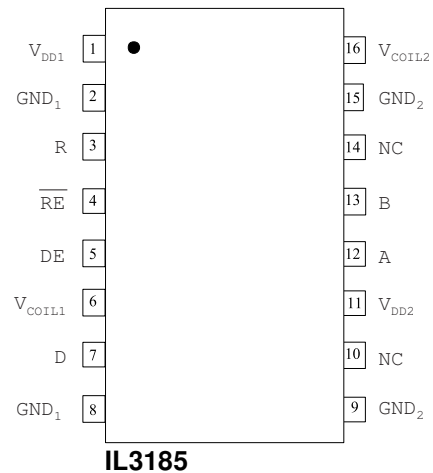

IL3122 Pin Connections (0.3" SOIC Package)

| | | |
|----|------------------------|---|
| 1 | V _{DD1} | Input power supply |
| 2 | GND ₁ | Ground return for V _{DD1} |
| 3 | R | Output data from bus |
| 4 | $\overline{\text{RE}}$ | Read enable (if RE is high, R is high impedance) |
| 5 | DE | Drive enable |
| 6 | V _{COIL1} | Coils for DE and D (connect to V _{DD1}) |
| 7 | D | Data input to bus |
| 8 | GND ₁ | Internally connected to pin 2 for 0.3" package; no internal connection on 0.15" IL3122-3 |
| 9 | GND ₂ | Ground return for V _{DD2} (internally connected to pin 15) |
| 10 | Y | Non-inverting driver bus line |
| 11 | V _{DD2} | Output power supply |
| 12 | Z | Inverting driver bus line |
| 13 | B | Inverting receiver bus line |
| 14 | A | Non-inverting receiver bus line |
| 15 | GND ₂ | Ground return for V _{DD2} (internally connected to pin 9) |
| 16 | V _{COIL2} | Coil for R |

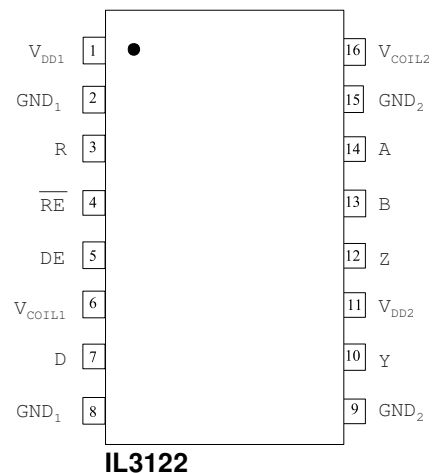

Driver Section

| Electrical Specifications (V _{DD1} = 3 V – 5.5 V; V _{DD2} = 4.5 V – 5.5 V; T = –40°C – 85°C unless otherwise stated) | | | | | | |
|--|---------------------------------------|------------------|------|-----------------|----------|--|
| Parameters | Symbol | Min. | Typ. | Max. | Units | Test Conditions |
| Coil Input Resistance | R _{COIL} | 47 | 85 | 112 | Ω | T = 25°C |
| Coil Input Resistance | R _{COIL} | 31 | 85 | 128 | Ω | T = –40°C – 85°C |
| Coil Resistance Temperature Coefficient | TC R _{COIL} | | 0.2 | 0.25 | Ω/°C | |
| Coil Inductance | L _{COIL} | | 9 | | nH | |
| High Level Input Current | I _{INH} | 0.5 | 1 | | mA | t _{IR} = t _{IF} = 3 ns; |
| Low Level Input Current | I _{INL} | | 3.5 | 5 | mA | C _{BOOST} = 16 pF |
| Output voltage | | | | V _{DD} | V | I _O = 0 |
| Differential Output Voltage | V _{OD1} | | | V _{DD} | V | I _O = 0 |
| Differential Output Voltage | V _{OD2} | 2 | 3 | | V | R _L = 100 Ω, V _{DD} = 5 V |
| Differential Output Voltage ⁽⁶⁾ | V _{OD3} | 1.5 | 2.3 | | V | R _L = 54 Ω, V _{DD} = 5 V |
| Change in Magnitude ⁽⁷⁾ of Differential Output Voltage | Δ V _{OD} | | | ±0.2 | V | R _L = 54 Ω or 100 Ω |
| Common Mode Output Voltage | V _{OC} | | | 3 | V | R _L = 54 Ω or 100 Ω |
| Change in Magnitude ⁽⁷⁾ of Common Mode Output Voltage | Δ V _{OC} | | | 0.2 | V | R _L = 54 Ω or 100 Ω |
| Output Current ⁽⁴⁾ | | | | 1 –0.8 | mA mA | Output disabled, V _O = 12 V V _O = –7 V |
| Short-circuit Output Current ¹ | I _{OS} | 60 | | 250 | mA | –7 V < V _O < 12 V |
| Supply Current | (V _{DD2} = +5 V) | I _{DD2} | 6 | 7 | mA | No Load (Outputs Enabled) |
| | (V _{DD1} = +5 V) | I _{DD1} | 2.5 | 3 | | |
| Supply Current (V _{DD1} = +3.3 V) | | I _{DD2} | 1.3 | 2 | mA | No Load (Outputs Enabled) |
| Common Mode Rejection | CM _{HL} , CM _{LL} | 15 | 20 | | kV/μs | V _T = 300 V _{peak} |

| Switching Specifications (V _{DD1} = 5 V; V _{DD2} = 5 V; T = –40°C – 85°C) | | | | | | |
|---|-----------------------|------|------|------|-------|--|
| Parameters | Symbol | Min. | Typ. | Max. | Units | Test Conditions |
| Data Rate | | 5 | | | Mbps | R _L = 54 Ω; C _L = 50 pF; C _{boost} = 16pF |
| Differential Output Prop Delay | t _D (OD) | | 40 | 65 | ns | |
| Pulse Skew ⁽¹⁰⁾ | t _{SK} (P) | | 6 | 15 | ns | |
| Differential Output Rise and Fall Time | t _r (OD) | 3 | 12 | 25 | ns | |
| Drive Enable Time to High Level | t _{PZH} | | 25 | 40 | ns | |
| Drive Enable Time to Low Level | t _{PZL} | | 25 | 40 | ns | |
| Drive Disable Time from High Level | t _{PHZ} | | 25 | 40 | ns | |
| Drive Disable Time from Low Level | t _{PLZ} | | 25 | 40 | ns | |
| Skew Limit ⁽³⁾ | t _{SK} (LIM) | | | 8 | ns | |

| Switching Specifications (V _{DD1} = 3.3 V; V _{DD2} = 5 V; T = –40°C – 85°C) | | | | | | |
|---|-----------------------|------|------|------|-------|--|
| Parameters | Symbol | Min. | Typ. | Max. | Units | Test Conditions |
| Data Rate | | 5 | | | Mbps | R _L = 54 Ω; C _L = 50 pF; C _{boost} = 16pF |
| Differential Output Prop Delay | t _D (OD) | | 40 | 65 | ns | |
| Pulse Skew ⁽¹⁰⁾ | t _{SK} (P) | | 6 | 20 | ns | |
| Differential Output Rise and Fall Time | t _r (OD) | 3 | 12 | 25 | ns | |
| Drive Enable Time to High Level | t _{PZH} | | 25 | 40 | ns | |
| Drive Enable Time to Low Level | t _{PZL} | | 25 | 40 | ns | |
| Drive Disable Time from High Level | t _{PHZ} | | 25 | 40 | ns | |
| Drive Disable Time from Low Level | t _{PLZ} | | 25 | 40 | ns | |
| Skew Limit ⁽³⁾ | t _{SK} (LIM) | | | 8 | ns | |

Receiver Section

| Electrical Specifications (V _{DD1} = 3 V – 5.5 V; V _{DD2} = 4.5 V – 5.5 V; T = –40°C – 85°C unless otherwise stated) | | | | | | |
|--|----------------------|-----------------------|-----------------------|------|-------|---|
| Parameters | Symbol | Min. | Typ. | Max. | Units | Test Conditions |
| Coil Resistance | R _{COIL} | 47 | 85 | 112 | Ω | T = 25°C |
| | | 31 | 85 | 128 | Ω | T = –40°C – 85°C |
| Coil Resistance Temperature Coefficient | TC R _{COIL} | | 0.2 | 0.25 | Ω/°C | |
| Positive-going Input Threshold | V _{IT+} | | | 0.2 | V | –7 V < V _{CM} < 12 V |
| Negative-going Input Threshold | V _{IT–} | –0.2 | | | V | –7 V < V _{CM} < 12 V |
| Hysteresis Voltage (V _{it+} – V _{it–}) | V _{HYS} | | 70 | | mV | V _{CM} = 0V, T = 25°C |
| High Level Digital Output Voltage | V _{OH} | V _{DD} – 0.2 | V _{DD} – 0.2 | | V | V _{ID} = 200 mV I _{OH} = 4 mA |
| Low Level Digital Output Voltage | V _{OL} | | | 0.8 | V | V _{ID} = –200 mV I _{OL} = 4 mA |
| High impedance state output current | I _{OZ} | | | 10 | μA | 0.4 ≤ V _O ≤ (V _{DD2} – 0.5) V |
| Line Input Current ⁽⁸⁾ | I _I | | | 1 | mA | V _I = 12 V |
| | | | | –0.8 | | V _I = –7 V |
| Input Resistance | r _I | 12 | 25 | | kΩ | |

| Switching Specifications (V _{DD1} = 5 V; V _{DD2} = 5 V; C _{boost} = 16pF; T = –40°C – 85°C) | | | | | | |
|--|----------------------|------|------|------|-------|--|
| Parameters | Symbol | Min. | Typ. | Max. | Units | Test Conditions |
| Data Rate | | 5 | | | Mbps | R _L = 54 Ω, C _L = 50 pF |
| Propagation Delay ⁽⁹⁾ | t _{PD} | | 50 | 85 | ns | –1.5 ≤ V _O ≤ 1.5 V, C _L = 15 pF |
| Pulse Skew ⁽¹⁰⁾ | t _{SK(P)} | | 10 | 17 | ns | –1.5 ≤ V _O ≤ 1.5 V, C _L = 15 pF |
| Skew Limit ⁽³⁾ | t _{SK(LIM)} | | 2 | 8 | ns | R _L = 54 Ω, C _L = 50 pF |
| Read Enable Time to High Level | t _{PZH} | | 4 | 40 | ns | C _L = 15 pF |
| Read Enable Time to Low Level | t _{PZL} | | 4 | 40 | ns | |
| Read Disable Time from High Level | t _{PHZ} | | 4 | 40 | ns | |
| Read Disable Time from Low Level | t _{PLZ} | | 4 | 40 | ns | |

| Switching Specifications (V _{DD1} = 3.3 V; V _{DD2} = 5 V; C _{boost} = 16pF; T = –40°C – 85°C) | | | | | | |
|--|----------------------|------|------|------|-------|--|
| Parameters | Symbol | Min. | Typ. | Max. | Units | Test Conditions |
| Data Rate | | 5 | | | Mbps | R _L = 54 Ω, C _L = 50 pF |
| Propagation Delay ⁽⁹⁾ | t _{PD} | | 55 | 85 | ns | –1.5 ≤ V _O ≤ 1.5 V, C _L = 15 pF |
| Pulse Skew ⁽¹⁰⁾ | t _{SK(P)} | | 12 | 20 | ns | –1.5 ≤ V _O ≤ 1.5 V, C _L = 15 pF |
| Skew Limit ⁽³⁾ | t _{SK(LIM)} | | 4 | 10 | ns | R _L = 54 Ω, C _L = 50 pF |
| Read Enable Time to High Level | t _{PZH} | | 5 | 10 | ns | C _L = 15 pF |
| Read Enable Time to Low Level | t _{PZL} | | 5 | 10 | ns | |
| Read Disable Time from High Level | t _{PHZ} | | 5 | 10 | ns | |
| Read Disable Time from Low Level | t _{PLZ} | | 17 | 10 | ns | |

Insulation Specifications

| Parameters | Symbol | Min. | Typ. | Max. | Units | Test Conditions |
|---|-----------------|-------|-------------------|------|------------------|-------------------------------------|
| Comparative Tracking Index | CTI | ≥175 | | | V | Per IEC 60112 |
| Endurance Voltage (Maximum Working Voltage for Indefinite Life) | AC | 1000 | | | V _{RMS} | At maximum operating temperature |
| | DC | 1500 | | | V _{DC} | |
| Creepage Distance (external) | 0.15" SOIC | 4.03 | | | mm | Per IEC 60601 |
| | 0.3" SOIC | 8.03 | 8.3 | | | |
| Total Barrier Thickness (internal) | | 0.012 | 0.013 | | mm | |
| Barrier Resistance ⁽⁵⁾ | R _{IO} | | >10 ¹⁴ | | Ω | 500 V |
| Barrier Capacitance ⁽⁵⁾ | C _{IO} | | 7 | | pF | f = 1 MHz |
| Leakage Current | | | 0.2 | | μA | 240 V _{RMS} , 60 Hz |

Thermal Characteristics

| Parameter | | Symbol | Min. | Typ. | Max. | Units | Test Conditions |
|--|-------------------------|---------------|------|----------|-------------|-------|---------------------------------|
| Junction–Ambient Thermal Resistance | 0.15" SOIC 0.3" SOIC | θ_{JA} | | 82 67 | | °C/W | Double-sided PCB in free air |
| Junction–Case (Top) Thermal Resistance | 0.15" SOIC 0.3" SOIC | θ_{JC} | | 8 12 | | | |
| Junction–Ambient Thermal Resistance | 0.3" SOIC | θ_{JA} | | 46 | | | 2s2p PCB in free air per JESD51 |
| Junction–Case (Top) Thermal Resistance | | θ_{JC} | | 9 | | | |
| Power Dissipation | 0.15" SOIC 0.3" SOIC | P_D | | | 700 1500 | mW | |

Notes:

1. All voltages are with respect to network ground except differential I/O bus voltages.
2. Differential input/output voltage is measured at the non-inverting terminal A with respect to the inverting terminal B.
3. Skew limit is the maximum difference in any two channels in one device.
4. The power-off measurement in ANSI Standard EIA/TIA-422-B applies to disabled outputs only and is not applied to combined inputs and outputs.
5. All typical values are at V_{DD1} , $V_{DD2} = 5\text{ V}$ or $V_{DD1} = 3.3\text{ V}$ and $T_A = 25^\circ\text{C}$.
6. While $-7\text{ V} < V_{CM} < 12\text{ V}$, the minimum V_{OD2} with a $54\ \Omega$ load is either $\frac{1}{2} V_{OD1}$ or 1.5 V , whichever is greater.
7. $\Delta|V_{OD}|$ and $\Delta|V_{OC}|$ are the changes in magnitude of V_{OD} and V_{OC} , respectively, that occur when the input is changed from one logic state to the other.
8. This applies for both power on and power off; refer to ANSI standard RS-485 for exact condition. The EIA/TIA-422-B limit does not apply for a combined driver and receiver terminal.
9. Includes 10 ns read enable time. Maximum propagation delay is 25 ns after read assertion.
10. Pulse skew is defined as the $|t_{PLH} - t_{PHL}|$ of each channel.

Applications Information

Input Resistor Values

The IL3122 and IL3185 are current-mode devices. Changes in input coil current switch internal spintronic GMR sensors. Inputs are logically high when the coil voltage is high, that is when there is no coil current.

A single resistor is required to limit the input coil current to the 5 mA threshold current. The absolute maximum current through any coil is 25 mA.

Typical Input Resistor Values

| V _{COIL} | 0.125W, 5% Resistor |
|-------------------|---------------------|
| 3.3 V | 510 Ω |
| 5 V | 820 Ω |

The table shows typical values for the external resistor in 5 V and 3 V logic systems. As always, these values are approximate and should be adjusted for temperature or other application specifics. If the expected temperature range is large, 1% tolerance resistors may provide additional design margin.

Boost Capacitor

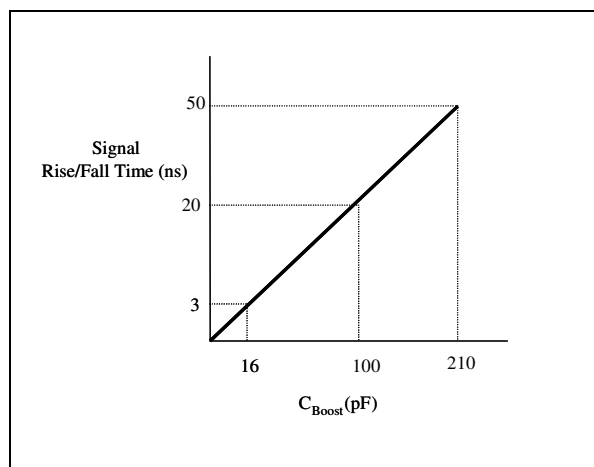

Figure 2. C_{boost} Selector

The boost capacitor in parallel with the current-limiting resistor boosts the instantaneous coil current at the signal transition. This ensures switching and reduces propagation delay and reduces pulse-width distortion.

Select the value of the boost capacitor based on the rise and fall times of the signal driving the inputs. The instantaneous boost capacitor current is proportional to input edge speeds ($C \frac{dV}{dt}$). Select a capacitor value based on the rise and fall times of the input signal to be isolated that provides approximately 20 mA of additional “boost” current. Figure 2 is a guide to boost capacitor selection. For high-speed logic signals ($t_r, t_f < 10$ ns), a 16 pF capacitor is recommended. The capacitor value is generally not critical; if in doubt, choose a higher value up to a maximum of 470 pF.

RS-485 and RS-422 Busses

RS-485 and RS-422 are differential (balanced) data transmission standards for use over long distances or in noisy environments. RS-422 is an RS-485 subset, so RS-485 transceivers are also RS-422-compliant. RS-422 is a multi-drop standard allowing only one driver and up to 10 receivers on each bus (assuming unit load receivers). RS-485 is a true multipoint standard which allows up to 32 unit load devices (any combination of drivers and receivers) on each bus. To allow for multipoint operation, RS-485 requires drivers to handle bus contention without damage. Another important advantage of RS-485 is the extended common-mode range (CMR), which requires driver outputs and receiver inputs withstand +12 V to -7 V. RS-422 and RS-485 are intended for runs as long as 4,000 feet (1,200 m), so the wide CMR is necessary for ground potential differences, as well as voltages induced in the cable by external fields.

Receiver Features

IL3000 transceivers have differential input receivers for maximum noise immunity and common-mode rejection. Input sensitivity is ± 200 mV as required by the RS-422 and RS-485 specifications. The receivers include a “fail-safe if open” function that guarantees a high level receiver output if the receiver inputs are unconnected (floating). Receivers easily meet the data rates supported by the corresponding driver. IL3000-Series receiver outputs have tri-state capabilities with active low RE inputs.

Driver Features

The RS485/422 driver is a differential output device that delivers at least 1.5 V across a 54 Ω load (RS-485), and at least 2 V across a 100 Ω load (RS-422). The driver features low propagation delay skew to maximize bit width and minimize EMI. IL3122 and IL3185 drivers have tri-state capability with an active high DE input.

Cabling, Data Rate and Terminations

Cabling

Use twisted-pair cable. The cable can be unshielded if it is short (less than 10 meters) and the data rate is slow (less than 100 Kbps). Otherwise, use screened cable with the shield tied to earth ground at one end only. Do not tie the shield to digital ground. The other end of the shield may be tied to earth ground through an RC network. This prevents a DC ground loop in the shield. Shielded cable minimizes EMI emissions and external noise coupling to the bus.

Data Rate

The longer the cable, the slower the data rate. The RS-485 bus can transmit ground over 4,000 feet (1,200 meters) or at 10 Mbps, but not both at the same time. Transducer and cable characteristics combine to act as a filter with the general response shown in Figure 3. Other parameters such as acceptable jitter affect the final cable length versus data rate tradeoff. Less jitter means better signal quality but shorter cable lengths or slower data rates. Figure 4 shows a generally accepted 30% jitter and a corresponding data rate versus cable length.

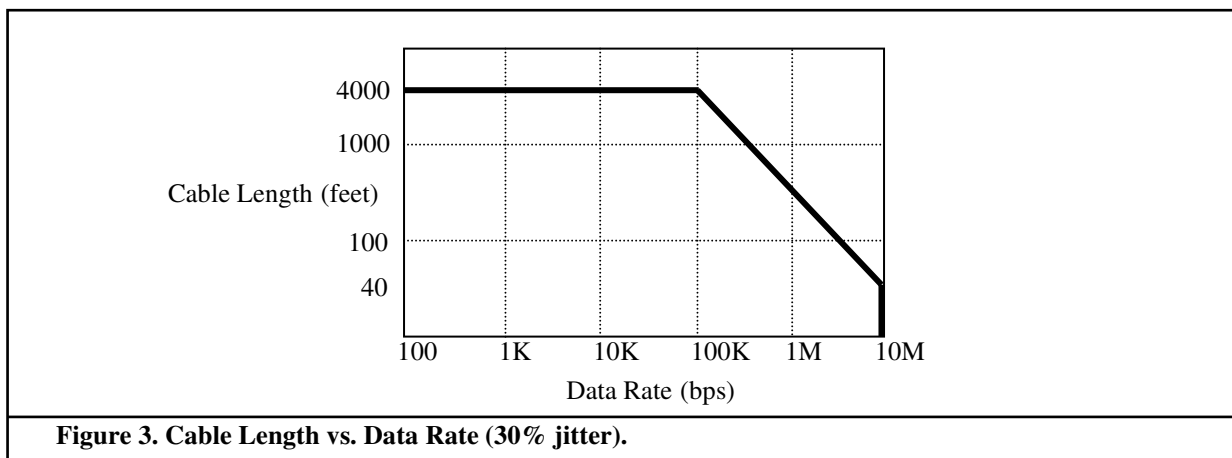

Terminations

Transmission lines should be terminated to avoid reflections that cause data errors. In RS-485 systems both ends of the bus, not every node, should be terminated. In RS-422 systems only the receiver end should be terminated.

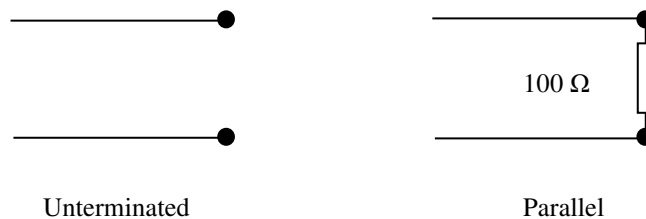

Proper termination is imperative when using IL3185 and IL3122 to minimize reflections. Unterminated lines are only suitable for very low data rates and very short cable runs, otherwise line reflections cause problems. Parallel terminations are the most popular. They allow high data rates and excellent signal quality.

Occasionally in noisy environments, fast pulses or noise appearing on the bus lines cause errors. One way of alleviating such errors without adding circuit delays is to place a series resistor in the bus line. Depending on the power supply, the resistor should be between 300 Ω (3 V supply) and 500 Ω (5 V supply).

Typical Coil Connections

| | |
|---|---|
| | |
| <p>$V_{DD1} = V_{DD2} = 5\text{ V}$ $R1, R2, R3 = 820\ \Omega$ $V_{DD1} = 3.3\text{ V}$ $R1, R2 = 510\ \Omega; R3 = 820\ \Omega$</p> | <p>$V_{DD1} = V_{DD2} = 5\text{ V}$ $R1, R2, R3 = 820\ \Omega$ $V_{DD1} = 3.3\text{ V}$ $R1, R2 = 510\ \Omega; R3 = 820\ \Omega$</p> |

Fail-Safe Operation

“Fail-safe operation” is defined here as the forcing of a logic high state on the “R” output in response to an open-circuit condition between the “A” and “B” lines of the bus, or when no drivers are active on the bus.

Proper biasing can ensure fail-safe operation, that is a known state when there are no active drivers on the bus. IL3185 and IL3122 Isolated Transceivers include internal pull-up and pull-down resistors of approximately 30 kΩ in the receiver section (R_{FS-INT}; see figure on following page). These internal resistors are designed to ensure failsafe operation but only if there are no termination resistors. The entire V_{DD} will appear between inputs “A” and “B” if there is no loading and no termination resistors, and there will be more than the required 200 mV with up to four RS-485/RS-422 worst-case Unit Loads of 12 kΩ. Many designs operating below 1 Mbps or less than 1,000 feet are unterminated. Termination resistors may not be necessary for very low data rates and very short cable runs because reflections have time to settle before data sampling, which occurs at the middle of the bit interval.

In busses with low-impedance termination resistors, however, the differential voltage across the conductor pair will be close to zero with no active drivers. In this case the state of the bus is indeterminate, and the idle bus will be susceptible to noise. For example, with 120 Ω termination resistors (R_T) on each end of the cable, and four Unit Loads (12 kΩ each), without external fail-safe biasing resistors the internal pull-up and pull-down resistors will produce a voltage between inputs “A” and “B” of only about 5 mV. This is not nearly enough to ensure a known state. External fail-safe biasing resistors (R_{FS-EXT}) at one end of the bus can ensure fail-safe operation with a terminated bus. Resistors should be selected so that under worst-case power supply and resistor tolerances there is at least 200 mV across the conductor pair with no active drivers to meet the input sensitivity specification of the RS-422 and RS-485 standards.

Using the same value for pull-up and pull-down biasing resistors maintains balance for positive- and negative going transitions. Lower-value resistors increase inactive noise immunity at the expense of quiescent power consumption. Note that each Unit Load on the bus adds a worst-case loading of 12 kΩ across the conductor pair, and 32 Unit Loads add 375 Ω worst-case loading. The more loads on the bus, the lower the required values of the biasing resistors.

In the example with two 120 Ω termination resistors and four Unit Loads, 560 Ω external biasing resistors provide more than 200 mV between “A” and “B” with adequate margin for power supply variations and resistor tolerances. This ensures a known state when there are no active drivers. Other illustrative examples are shown in the following table:

Fail-Safe Biasing

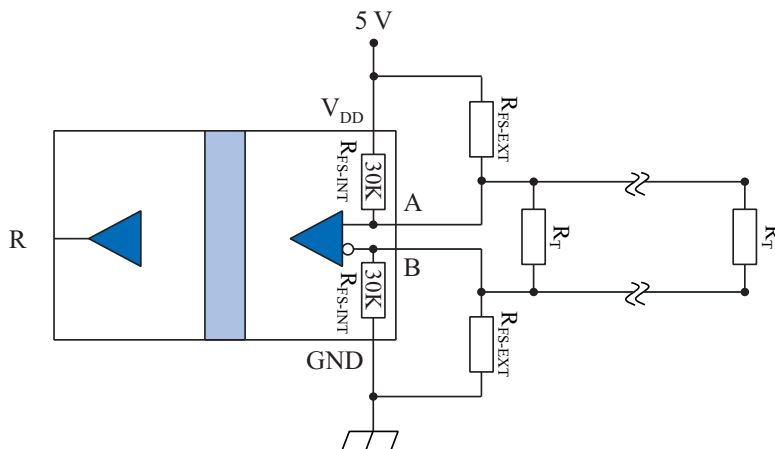

| R_{FS-EXT} | R_T | Loading | Nominal V_{A-B} (inactive) | Fail-Safe Operation? |
|---------------|--------------|-------------------------------------|---------------------------------|-------------------------|
| Internal Only | None | Four unit loads (12 k Ω ea.) | 238 mV | Yes |
| Internal Only | 120 Ω | Four unit loads (12 k Ω ea.) | 5 mV | No |
| 560 Ω | 120 Ω | Four unit loads (12 k Ω ea.) | 254 mV | Yes |
| 510 Ω | 120 Ω | 32 unit loads (12 k Ω ea.) | 247 mV | Yes |

Power Supply Decoupling

Both V_{DD1} and V_{DD2} should be bypassed with 0.1 μ F typical (0.047 μ F minimum) capacitors placed as close as possible to the V_{DD} pins.

Maintaining Creepage

Creepage distances are often critical in isolated circuits. In addition to meeting JEDEC standards, NVE isolator packages have unique creepage specifications. Standard pad libraries often extend under the package, compromising creepage and clearance. Similarly, ground planes, if used, should be spaced to avoid compromising clearance. Package drawings and recommended pad layouts are included in this datasheet.

Magnetic Field Immunity

IsoLoop Isolators operate by imposing a magnetic field on a GMR sensor, which translates the change in field into a change in logic state. A magnetic shield and a Wheatstone Bridge configuration provide good immunity to external magnetic fields. Immunity to external magnetic fields can be enhanced by proper orientation of the device with respect to the field direction and larger boost capacitors.

An applied field in the “H1” direction is the worst case for magnetic immunity. In this case the external field is in the same direction as the applied internal field. In one direction it will tend to help switching; in the other it will hinder switching. This can cause unpredictable operation.

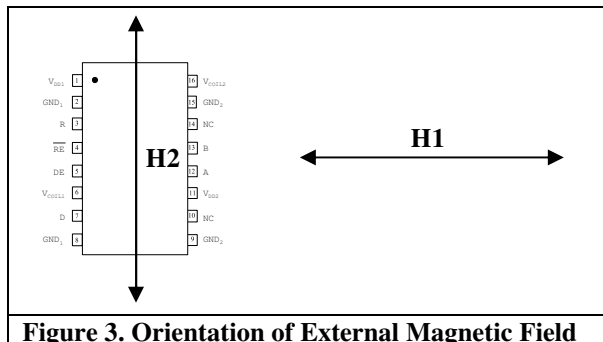

An applied field in the direction of “H2” has considerably less effect on the sensor and will result in significantly higher immunity levels as shown in Table 1.

The greatest magnetic immunity is achieved by adding a larger boost capacitor across the input resistor. Very high immunity can be achieved with this method.

Figure 3. Orientation of External Magnetic Field

| Method | Approximate Immunity | Immunity Description |
|---|----------------------|---|
| Field applied in direction H1 | ±20 Gauss | A DC current of 16 A flowing in a conductor 1 cm from the device could cause disturbance |
| Field applied in direction H2 | ±70 Gauss | A DC current of 56 A flowing in a conductor 1 cm from the device could cause disturbance |
| Field applied in any direction but with boost capacitor (470 pF) in circuit | ±250 Gauss | A DC current of 200 A flowing in a conductor 1 cm from the device could cause disturbance |
| Table 1. Magnetic Immunity | | |

Data Rate and Magnetic Field Immunity

It is easier to disrupt an isolated DC signal with an external magnetic field than it is to disrupt an isolated AC signal. Similarly, a DC magnetic field will have a greater effect on the device than an AC magnetic field of the same effective magnitude. For example, signals with pulses longer than 100 μ s are more susceptible to magnetic fields than shorter pulse widths. For input signals faster than 1 MHz, rising in less than 3 ns, a 470 pF field-boost capacitor provides as much as 400 Gauss immunity, while the same input capacitor might provide just 70 Gauss immunity at 50 kHz.

Package Drawings

0.15" 16-pin SOIC Package (-3 suffix)

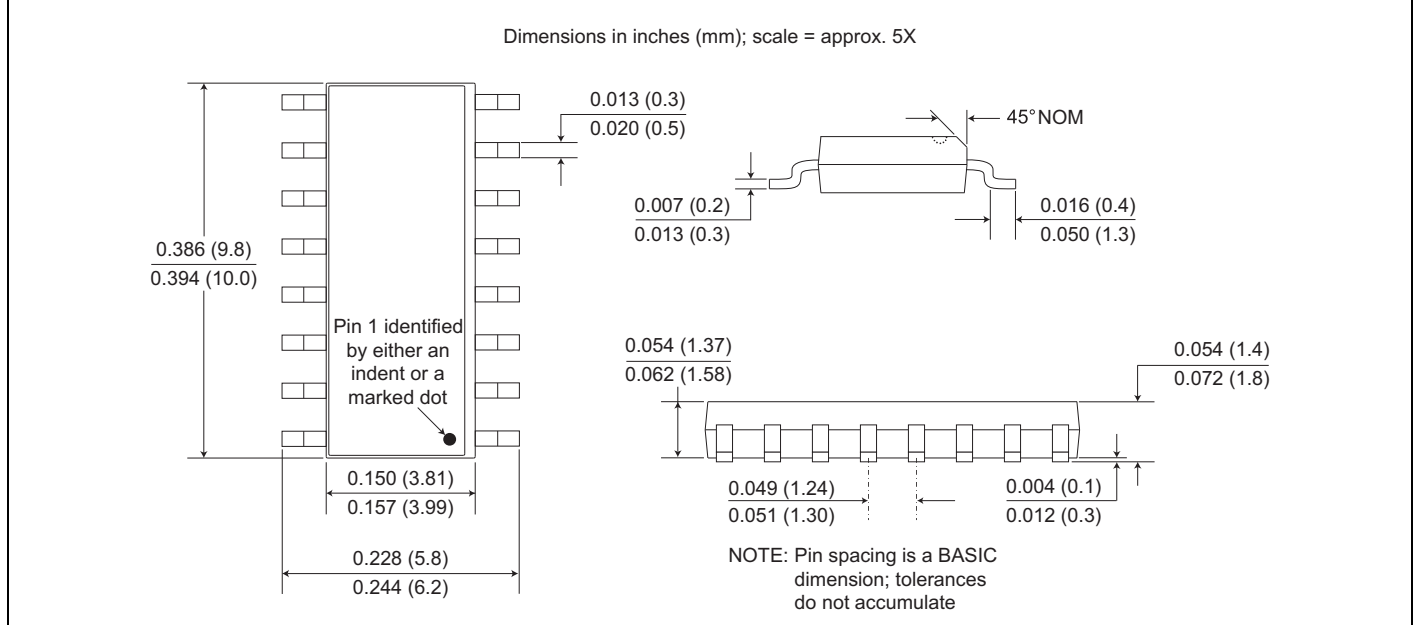

0.3" 16-pin SOIC Package (no suffix)

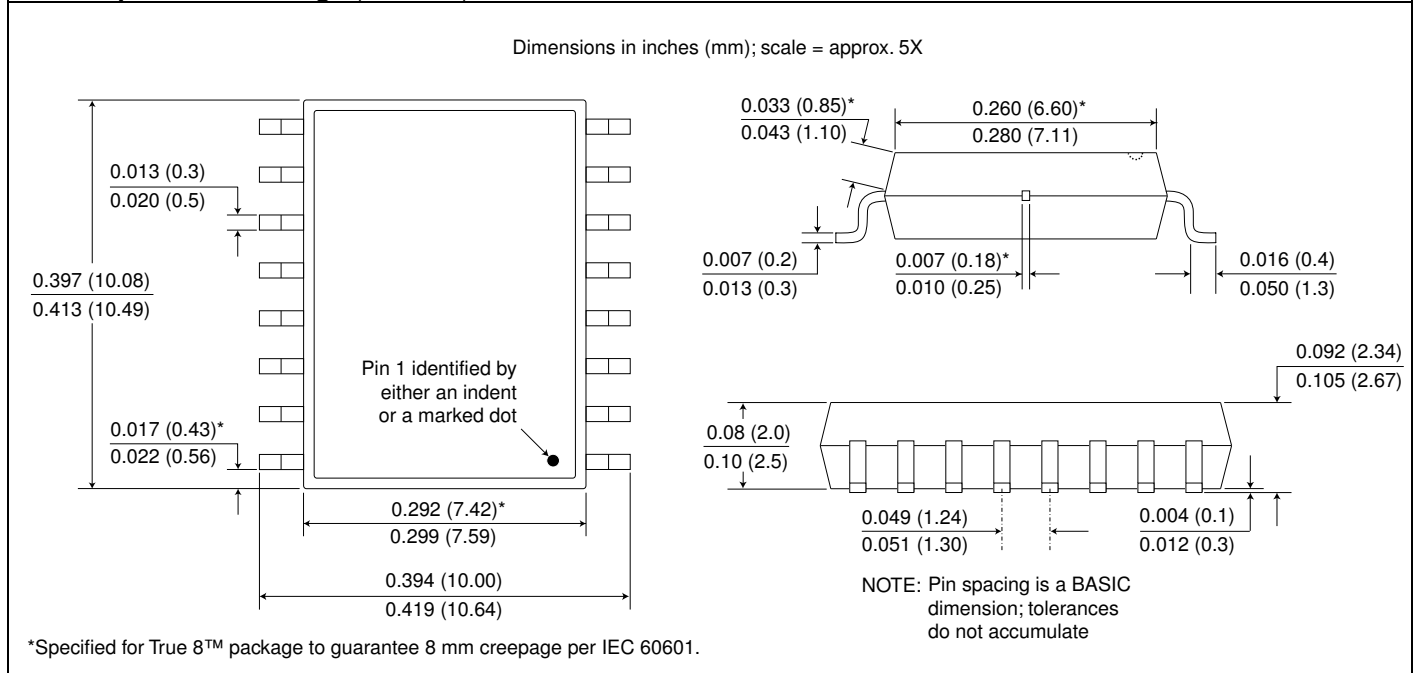

Recommended Pad Layouts

0.15" 16-pin SOIC Pad Layout

Dimensions in inches (mm); scale = approx. 5X

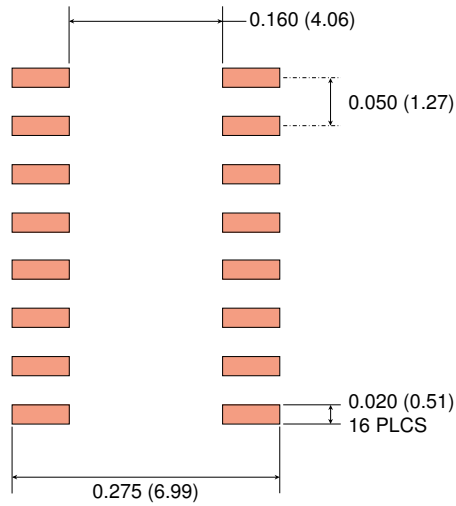

0.3" 16-pin SOIC Pad Layout

Dimensions in inches (mm); scale = approx. 5X

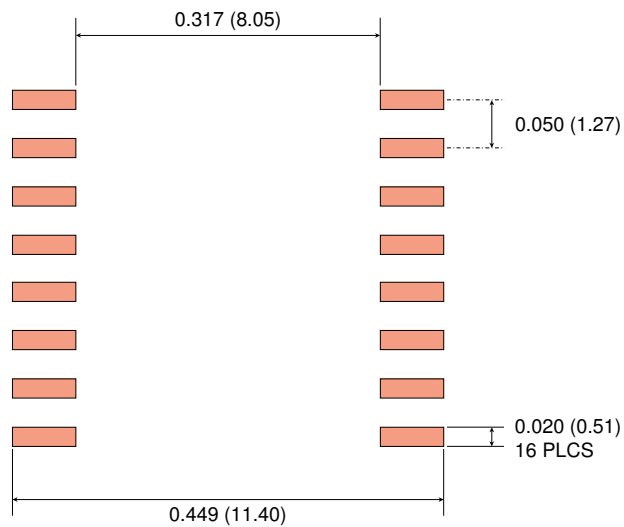

Ordering Information and Valid Part Numbers

IL 31 85 -3 E TR13

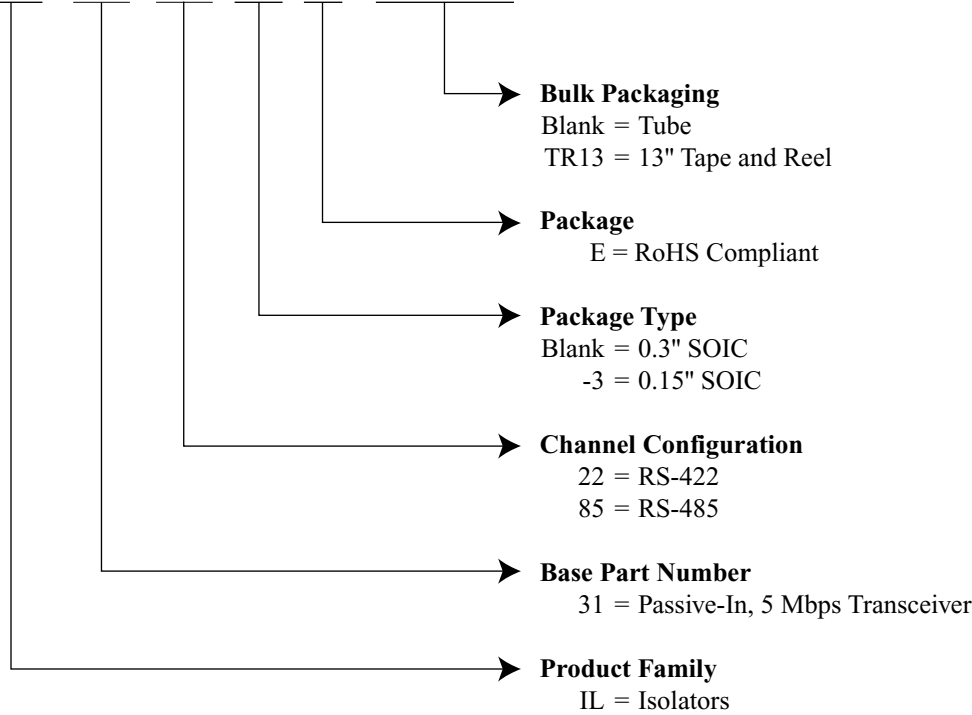

Valid Part Numbers

- IL3185E
- IL3185E TR13
- IL3185-3E
- IL3185-3E TR13

- IL3122E
- IL3122E TR13
- IL3122-3E
- IL3122-3E TR13



Revision History

ISB-DS-001 IL3185/22-Q October 2021

Changes

- Clarified RS-485 truth table (p. 1).
- Increased Working Voltage (V_{IORM}) to 600 V_{RMS} (p.3).
- Upgraded from VDE V 0884-10 to VDE V 0884-11 / IEC 60747-17 (p. 3).
- Clarified IL3185-3E and IL3122-3E pin 8 should not be connected (p. 4).
- Added thermal characteristics (p. 8).

ISB-DS-001 IL3185/22-P

Changes

- IEC 60747-5-5 (VDE 0884) certification.
- Upgraded from MSL 2 to MSL 1.
- Rearranged low level input current specification so maximum is more than minimum.

ISB-DS-001 IL3185/22-O

Changes

- Added VDE 0884 pending.
- Clarified switching specifications.
- Updated package drawings.
- Added recommended solder pad layouts.

ISB-DS-001 IL3185/22-N

Changes

- Detailed isolation and barrier specifications.
- Cosmetic changes.

ISB-DS-001-IL3185/22-M

Changes

- Added minimum/maximum coil resistance specifications.
- Misc. cosmetic changes.

ISB-DS-001-IL3185/22-L

Changes

- Update terms and conditions.

ISB-DS-001-IL3185/22-K

Changes

- Clarified ground pin connections (pp. 3-4).

ISB-DS-001-IL3185/22-J

Changes

- Changes to current-limiting resistor values (pp. 7 and 10).
- Details for boost capacitor selection (p. 7).

ISB-DS-001-IL3185/22-I

Changes

- Noted UL1577 approval.

ISB-DS-001-IL3185/22-H

Changes

- Added bus-protection ESD specification (15 kV).

ISB-DS-001-IL3185/22-G

Changes

- Added typical coil resistance and temperature coefficient specifications.
- Added note on package drawings that pin-spacing tolerances are non-accumulating.

Datasheet Limitations

The information and data provided in datasheets shall define the specification of the product as agreed between NVE and its customer, unless NVE and customer have explicitly agreed otherwise in writing. All specifications are based on NVE test protocols. In no event however, shall an agreement be valid in which the NVE product is deemed to offer functions and qualities beyond those described in the datasheet.

Limited Warranty and Liability

Information in this document is believed to be accurate and reliable. However, NVE does not give any representations or warranties, expressed or implied, as to the accuracy or completeness of such information and shall have no liability for the consequences of use of such information.

In no event shall NVE be liable for any indirect, incidental, punitive, special or consequential damages (including, without limitation, lost profits, lost savings, business interruption, costs related to the removal or replacement of any products or rework charges) whether or not such damages are based on tort (including negligence), warranty, breach of contract or any other legal theory.

Right to Make Changes

NVE reserves the right to make changes to information published in this document including, without limitation, specifications and product descriptions at any time and without notice. This document supersedes and replaces all information supplied prior to its publication.

Use in Life-Critical or Safety-Critical Applications

Unless NVE and a customer explicitly agree otherwise in writing, NVE products are not designed, authorized or warranted to be suitable for use in life support, life-critical or safety-critical devices or equipment. NVE accepts no liability for inclusion or use of NVE products in such applications and such inclusion or use is at the customer's own risk. Should the customer use NVE products for such application whether authorized by NVE or not, the customer shall indemnify and hold NVE harmless against all claims and damages.

Applications

Applications described in this datasheet are illustrative only. NVE makes no representation or warranty that such applications will be suitable for the specified use without further testing or modification.

Customers are responsible for the design and operation of their applications and products using NVE products, and NVE accepts no liability for any assistance with applications or customer product design. It is customer's sole responsibility to determine whether the NVE product is suitable and fit for the customer's applications and products planned, as well as for the planned application and use of customer's third party customers. Customers should provide appropriate design and operating safeguards to minimize the risks associated with their applications and products.

NVE does not accept any liability related to any default, damage, costs or problem which is based on any weakness or default in the customer's applications or products, or the application or use by customer's third party customers. The customer is responsible for all necessary testing for the customer's applications and products using NVE products in order to avoid a default of the applications and the products or of the application or use by customer's third party customers. NVE accepts no liability in this respect.

Limiting Values

Stress above one or more limiting values (as defined in the Absolute Maximum Ratings System of IEC 60134) will cause permanent damage to the device. Limiting values are stress ratings only and operation of the device at these or any other conditions above those given in the recommended operating conditions of the datasheet is not warranted. Constant or repeated exposure to limiting values will permanently and irreversibly affect the quality and reliability of the device.

Terms and Conditions of Sale

In case an individual agreement is concluded only the terms and conditions of the respective agreement shall apply. NVE hereby expressly objects to applying the customer's general terms and conditions with regard to the purchase of NVE products by customer.

No Offer to Sell or License

Nothing in this document may be interpreted or construed as an offer to sell products that is open for acceptance or the grant, conveyance or implication of any license under any copyrights, patents or other industrial or intellectual property rights.

Export Control

This document as well as the items described herein may be subject to export control regulations. Export might require a prior authorization from national authorities.

Automotive Qualified Products

Unless the datasheet expressly states that a specific NVE product is automotive qualified, the product is not suitable for automotive use. It is neither qualified nor tested in accordance with automotive testing or application requirements. NVE accepts no liability for inclusion or use of non-automotive qualified products in automotive equipment or applications.

In the event that customer uses the product for design-in and use in automotive applications to automotive specifications and standards, customer (a) shall use the product without NVE's warranty of the product for such automotive applications, use and specifications, and (b) whenever customer uses the product for automotive applications beyond NVE's specifications such use shall be solely at customer's own risk, and (c) customer fully indemnifies NVE for any liability, damages or failed product claims resulting from customer design and use of the product for automotive applications beyond NVE's standard warranty and NVE's product specifications.

An ISO 9001 Certified Company

NVE Corporation
11409 Valley View Road
Eden Prairie, MN 55344-3617 USA
Telephone: (952) 829-9217

www.nve.com
e-mail: iso-info@nve.com

©NVE Corporation
All rights are reserved. Reproduction in whole or in part is prohibited without the prior written consent of the copyright owner.

ISB-DS-001-IL3185/22-Q

October 2021