

- Ideal for 303.825 MHz Remote Control and Security Transmitters
- Very Low Series Resistance
- Quartz Frequency Stability
- Complies with Directive 2002/95/EC (RoHS)
- Tape and Reel Standard per ANSI/EIA-481
- Moisture Sensitivity Level: 1
- AEC-Q200 Qualified

RoHS
Compliant

RO3104E

**303.825 MHz
SAW
Resonator**

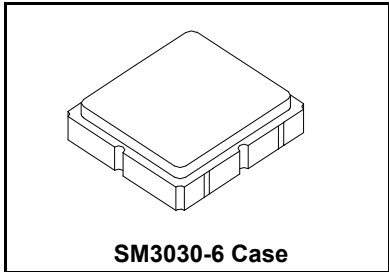

The RO3104E is a true one-port, surface-acoustic-wave (SAW) resonator in a surface-mount ceramic case. It provides reliable, fundamental mode quartz frequency stabilization of fixed-frequency transmitters operating at 303.825 MHz. This SAW is designed specifically for AM transmitters used in wireless security and remote control applications.

Absolute Maximum Ratings

Rating	Value	Units
CW RF Power Dissipation (See Typical Test Circuit)	0	dBm
DC Voltage Between Terminals (Observe ESD Precautions)	12	VDC
Case Temperature	-40 to +85	°C
Soldering Temperature (10 seconds, 5 cycles maximum)	+260	°C

Electrical Characteristics

Characteristic	Sym	Notes	Minimum	Typical	Maximum	Units
Frequency, +25 °C	Nominal Frequency	f_C	303.750		303.900	MHz
	Tolerance from 303.825 MHz	Δf_C			±75	kHz
Insertion Loss		IL		1.35	2.0	dB
Quality Factor	Unloaded Q	Q_U		10000		
	50 Ω Loaded Q	Q_L		1400		
Temperature Stability	Turnover Temperature	T_O	10	25	40	°C
	Turnover Frequency	f_O		f_C		
	Frequency Temperature Coefficient	FTC		0.032		ppm/°C ²
Frequency Aging	Absolute Value during the First Year	$ f_A $		10		ppm/yr
DC Insulation Resistance between Any Two Terminals			1.0			MΩ
RF Equivalent RLC Model	Motional Resistance	R_M		16		Ω
	Motional Inductance	L_M		85		μH
	Motional Capacitance	C_M		3.2		fF
	Transducer Static Capacitance	C_O		3.2		pF
Test Fixture Shunt Inductance		L_{TEST}		85		nH
Lid Symbolization			690, YWWS			
Standard Reel Quantity	Reel Size 7 Inch		500 Pieces/Reel			
	Reel Size 13 Inch		3000 Pieces/Reel			

 **CAUTION: Electrostatic Sensitive Device. Observe precautions for handling.**

NOTES:

1. The design, manufacturing process, and specifications of this device are subject to change.
2. US or International patents may apply.
3. RoHS compliant from the first date of manufacture.

Electrical Connections

The SAW resonator is bidirectional and may be installed with either orientation. The two terminals are interchangeable and unnumbered. The callout NC indicates no internal connection. The NC pads assist with mechanical positioning and stability. External grounding of the NC pads is recommended to help reduce parasitic capacitance in the circuit.

Pin	Connection
1	NC
2	Terminal
3	NC
4	NC
5	Terminal
6	NC

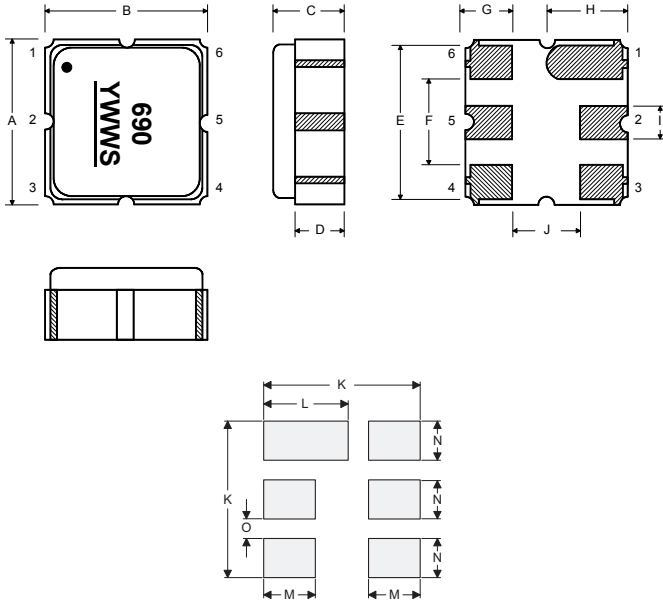

Case and Typical PCB Land Dimensions

Ref	mm			Inches		
	Min	Nom	Max	Min	Nom	Max
A	2.87	3.00	3.13	0.113	0.118	0.123
B	2.87	3.00	3.13	0.113	0.118	0.123
C	1.12	1.25	1.38	0.044	0.049	0.054
D	0.77	0.90	1.03	0.030	0.035	0.040
E	2.67	2.80	2.93	0.105	0.110	0.115
F	1.47	1.60	1.73	0.058	0.063	0.068
G	0.72	0.85	0.98	0.028	0.033	0.038
H	1.37	1.50	1.63	0.054	0.059	0.064
I	0.47	0.60	0.73	0.019	0.024	0.029
J	1.17	1.30	1.43	0.046	0.051	0.056
K		3.20			0.126	
L		1.70			0.067	
M		1.05			0.041	
N		0.81			0.032	
O		0.38			0.015	

Equivalent RLC Model



Temperature Characteristics

The curve shown accounts for resonator contribution only and does not include external LC component temperature effects.

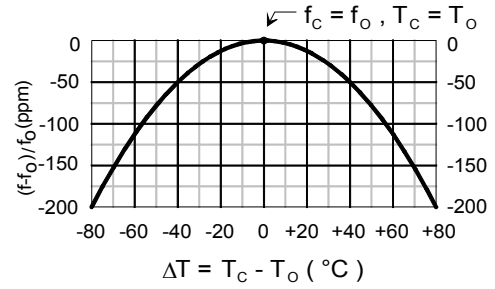

Characterization Test Circuit

Inductor L_{TEST} is tuned to resonate with the static capacitance, C_0 , at F_c .

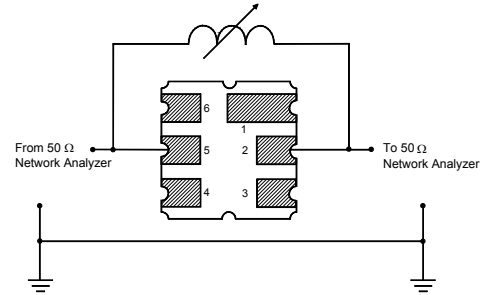

Power Dissipation Test

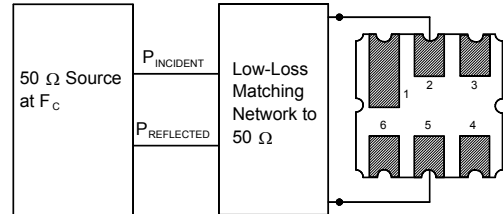

Example Application Circuits

Typical Low-Power Transmitter Application

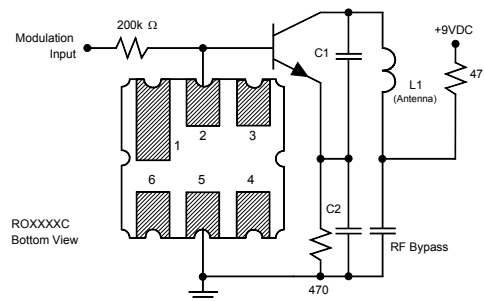

Typical Local Oscillator Application

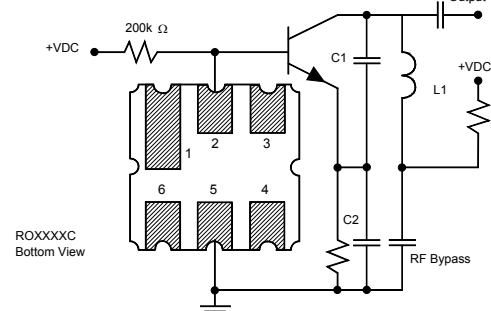

Recommended Reflow Profile

1. Preheating shall be fixed at 150~180°C for 60~90 seconds.
2. Ascending time to preheating temperature 150°C shall be 30 seconds min.
3. Heating shall be fixed at 220°C for 50~80 seconds and at 260°C +0/-5°C peak (10 seconds).
4. Time: 5 times maximum.

