

Description: 25x25x4mm GPS/Glonass SMD Mount

Series: Ceramic Patch

PART NUMBER: W3225

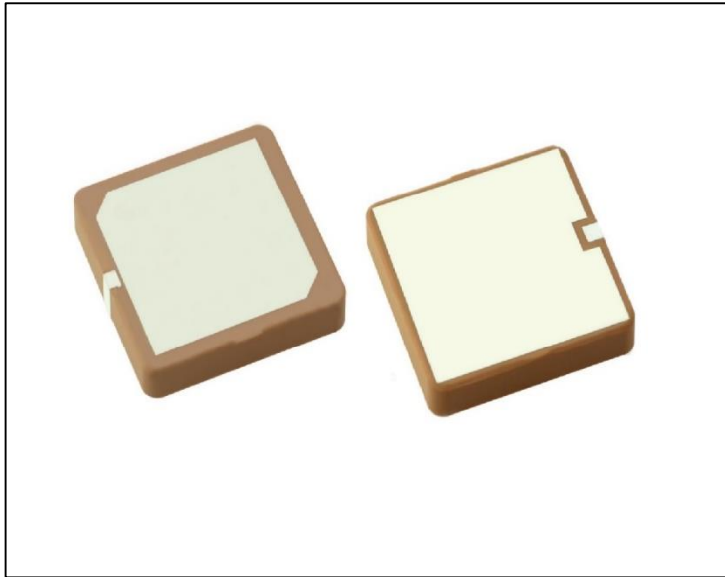

Features:

- 1575/1602MHz Dualband single feed antenna
- RHCP Polarization
- Zenith Gain +3dBic
- SMD compatible
- Tape & Reel packing

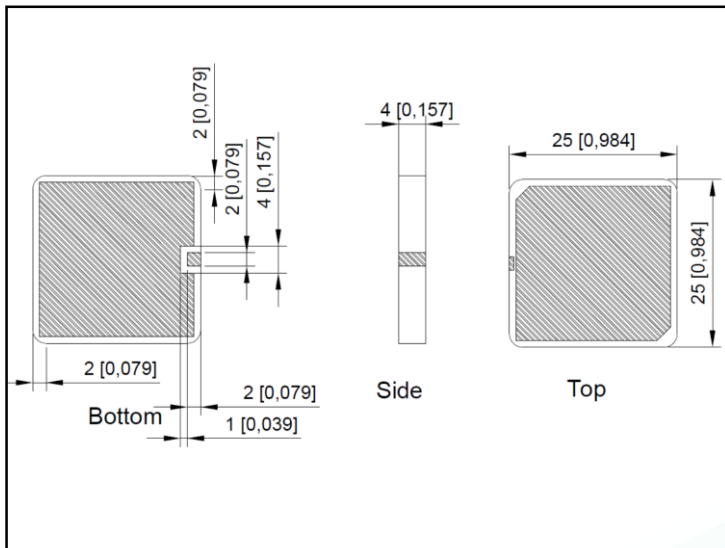

Applications:

- GPS and Glonass satellite receivers
- Tracking, Navigation, Satellite Positioning
- Fleet management
- Asset tracking

All dimensions are in mm / inches

Issue: 1652

In the effort to improve our products, we reserve the right to make changes judged to be necessary.

CONFIDENTIAL AND PROPRIETARY INFORMATION

This document contains confidential and proprietary information of Pulse Electronics, Inc. (Pulse) and is protected by copyright, trade secret and other state and federal laws. Its receipt or possession does not convey any rights to reproduce, disclose its contents, or to manufacture, use or sell anything it may describe. Reproduction, disclosure or use without specific written authorization of Pulse is strictly forbidden.

For more information:

Pulse Worldwide Headquarters
12220 World Trade Drive
San Diego, CA 92128
USA
Tel: 1-858-674-8100

Pulse/Larsen Antennas
18110 SE 34th St Bldg 2 Suite 250
Vancouver, WA 98683
USA
Tel: 1-360-944-7551

Europe Headquarters
Pulse GmbH & Do, KG
Zeppelinstrasse 15
Herrenberg, Germany
Tel: 49 7032 7806 0

Pulse (Suzhou) Wireless Products Co, Inc.
99 Huo Ju Road(#29 Bldg,4th Phase
Suzhou New District
Jiangsu Province, Suzhou 215009 PR China
Tel: 86 512 6807 9998



Description: 25x25x4mm GPS/Glonass SMD
Mount**Series:** Ceramic Patch**PART NUMBER:** W3225**ELECTRICAL SPECIFICATIONS**

Frequency	1575.42±1.023/1602.5625±4 MHz
Nominal Impedance	50 Ω
Return Loss*	<-10 dB
RHCP Gain (typical)*	3 dBiC
Zenith Axial Ratio(typical)*	4.2
Polarization:	RHCP

* Measured on 70 x 70 mm reference board

Description: 25x25x4mm GPS/Glonass SMD
Mount**Series:** Ceramic Patch**PART NUMBER:** W3225**MECHANICAL SPECIFICATIONS**

Material	Ceramic
Metallization	Silver
Size	25 x 24 x 4 mm
Weight	9.2 g
Mounting type	SMD

ENVIRONMENTAL SPECIFICATIONS

Operating temperature	-40/+85 ° C
-----------------------	-------------

Description: 25x25x4mm GPS/Glonass SMD Mount

Series: Ceramic Patch

PART NUMBER: W3225

MECHANICAL DRAWING

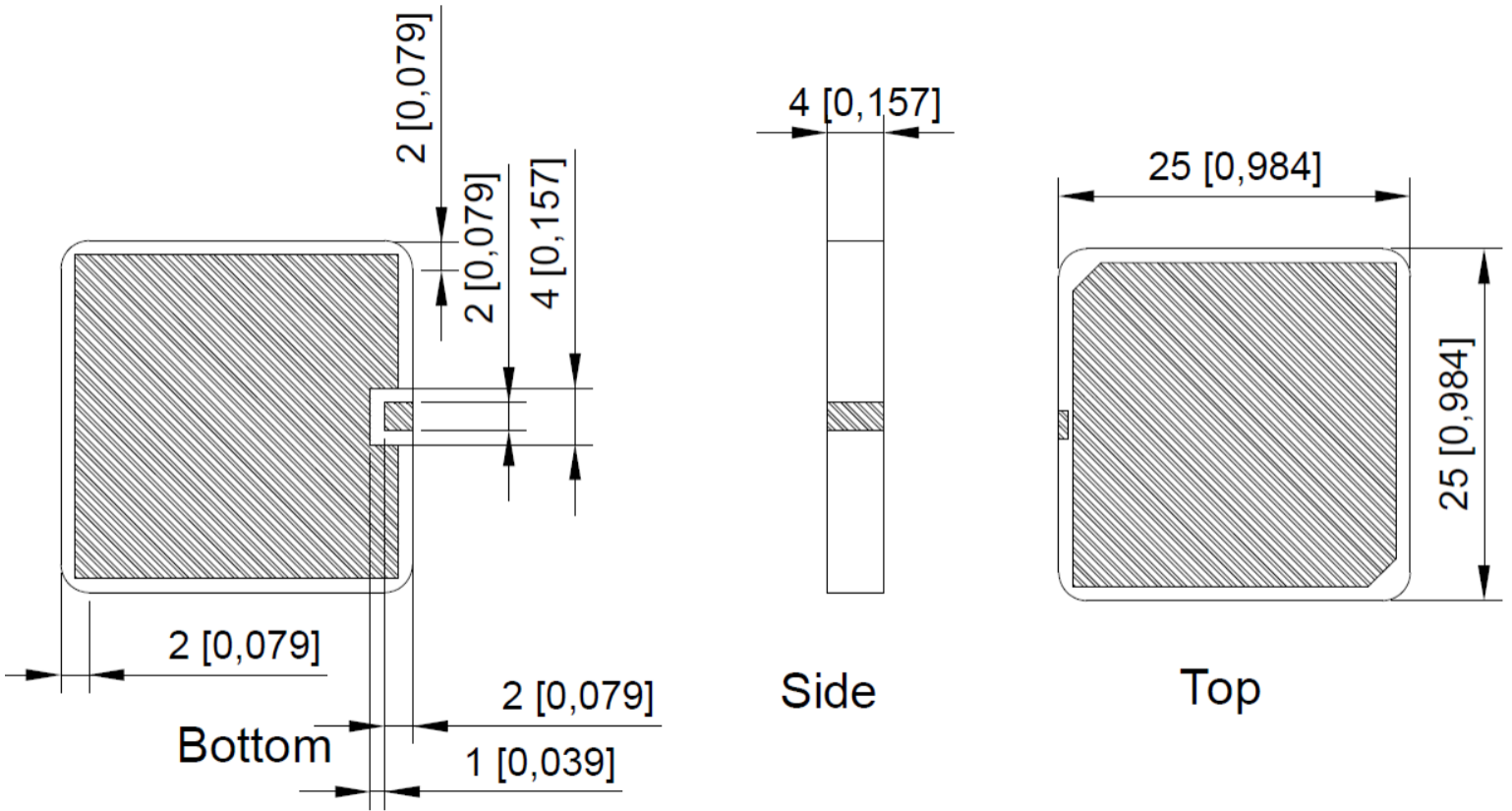

Issue: 1652

In the effort to improve our products, we reserve the right to make changes judged to be necessary.

CONFIDENTIAL AND PROPRIETARY INFORMATION

This document contains confidential and proprietary information of Pulse Electronics, Inc. (Pulse) and is protected by copyright, trade secret and other state and federal laws. Its receipt or possession does not convey any rights to reproduce, disclose its contents, or to manufacture, use or sell anything it may describe. Reproduction, disclosure or use without specific written authorization of Pulse is strictly forbidden.

Description: 25x25x4mm GPS/Glonass SMD Mount

Series: Ceramic Patch

PART NUMBER: W3225

OTHER SPECIFICATIONS

Test Condition Ground Plane (Example for PCB 1 mm)

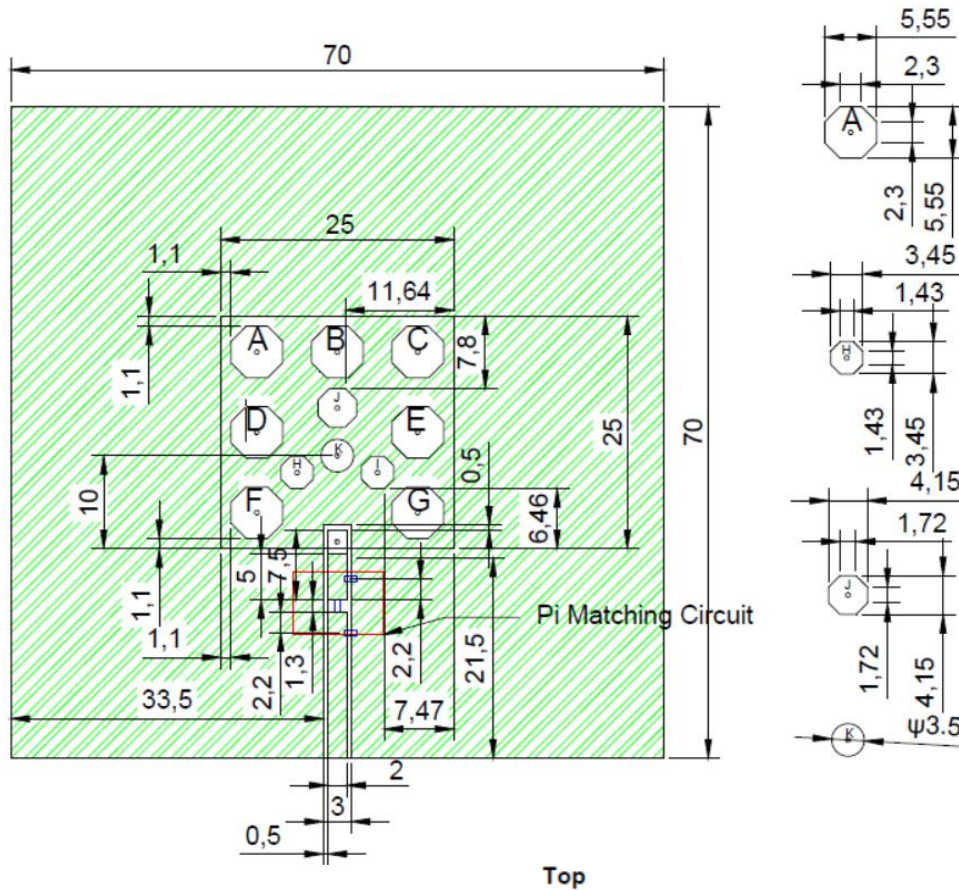

A.B.C.D.E.F.G. are same soldering pads.
 H.I are same soldering pads.
 Bottom side needs π matching circuit.
 Tolerance : ± 0.2 mm
 A.B.C.D.E.F.G.H.I.J.K are ground pads

Unit : mm

π matching circuit :

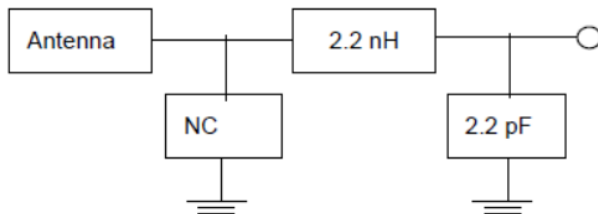

Issue: 1652

In the effort to improve our products, we reserve the right to make changes judged to be necessary.
 CONFIDENTIAL AND PROPRIETARY INFORMATION

This document contains confidential and proprietary information of Pulse Electronics, Inc. (Pulse) and is protected by copyright, trade secret and other state and federal laws. Its receipt or possession does not convey any rights to reproduce, disclose its contents, or to manufacture, use or sell anything it may describe. Reproduction, disclosure or use without specific written authorization of Pulse is strictly forbidden.

Description: 25x25x4mm GPS/Glonass SMD Mount

Series: Ceramic Patch

PART NUMBER: W3225

OTHER SPECIFICATIONS

Recommended Reflow Soldering Profile

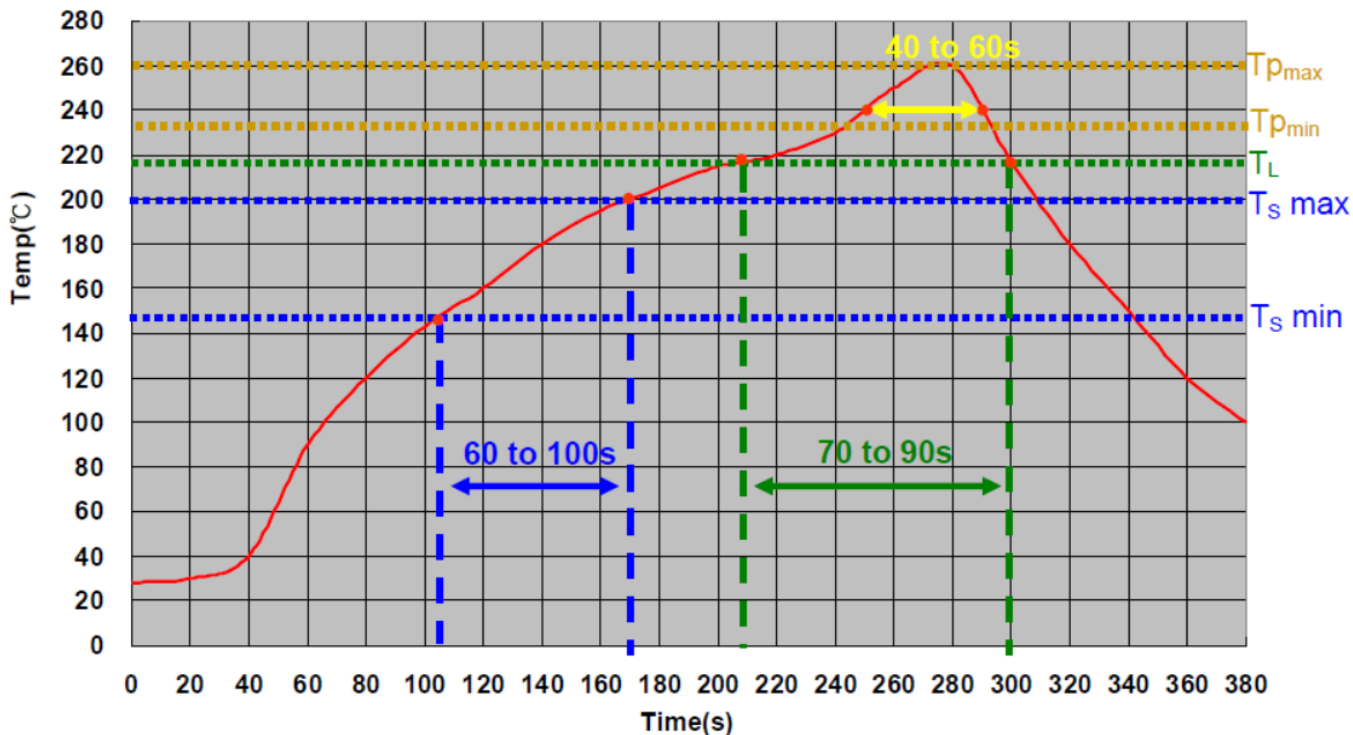

Ts Min	150°C
Ts Max	200°C
Time Tsm in to Tsm ax	60s to 100s
Liquidus	217°C
Time above Liquidus	70 to 90s
Minimum Peak Temperature	235°C
Maximum Peak Temperature	260°C

* The thickness of Solder should be controlled to be higher than 0.1 mm.

Description: 25x25x4mm GPS/Glonass SMD Mount

Series: Ceramic Patch

PART NUMBER: W3225

CHARTS

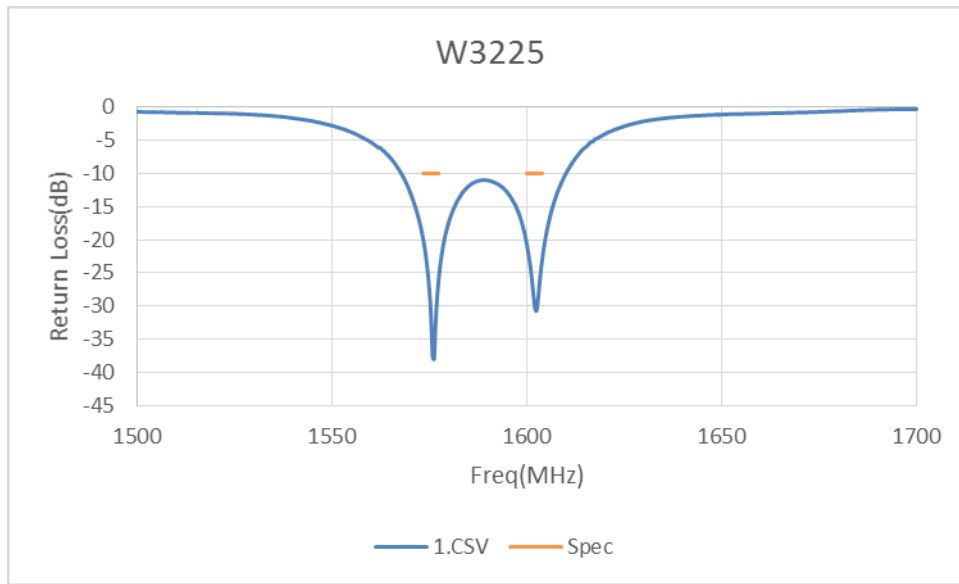

Return Loss

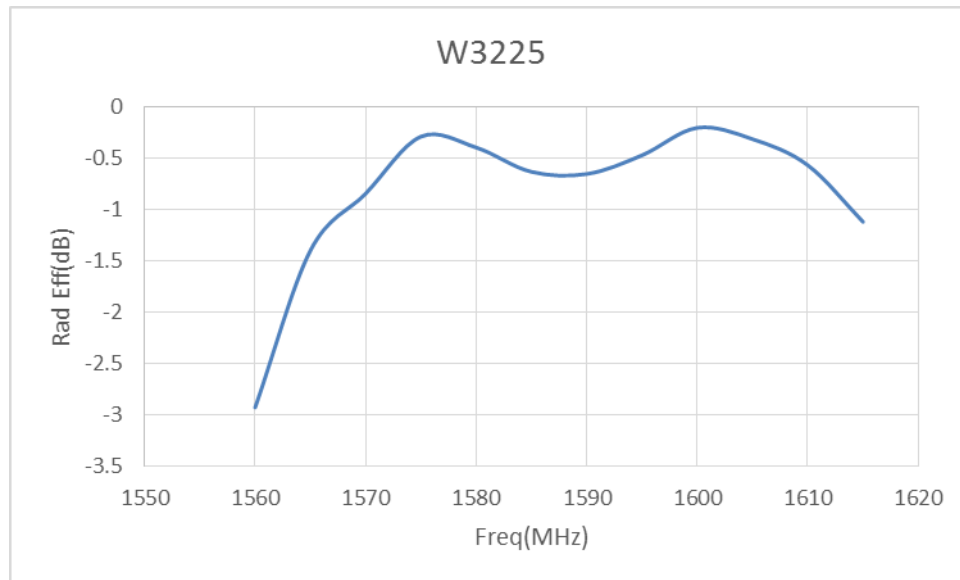

Total Radiation Efficiency

Issue: 1652

In the effort to improve our products, we reserve the right to make changes judged to be necessary.

CONFIDENTIAL AND PROPRIETARY INFORMATION

This document contains confidential and proprietary information of Pulse Electronics, Inc. (Pulse) and is protected by copyright, trade secret and other state and federal laws. Its receipt or possession does not convey any rights to reproduce, disclose its contents, or to manufacture, use or sell anything it may describe. Reproduction, disclosure or use without specific written authorization of Pulse is strictly forbidden.

Description: 25x25x4mm GPS/Glonass SMD Mount

Series: Ceramic Patch

PART NUMBER: W3225

CHARTS

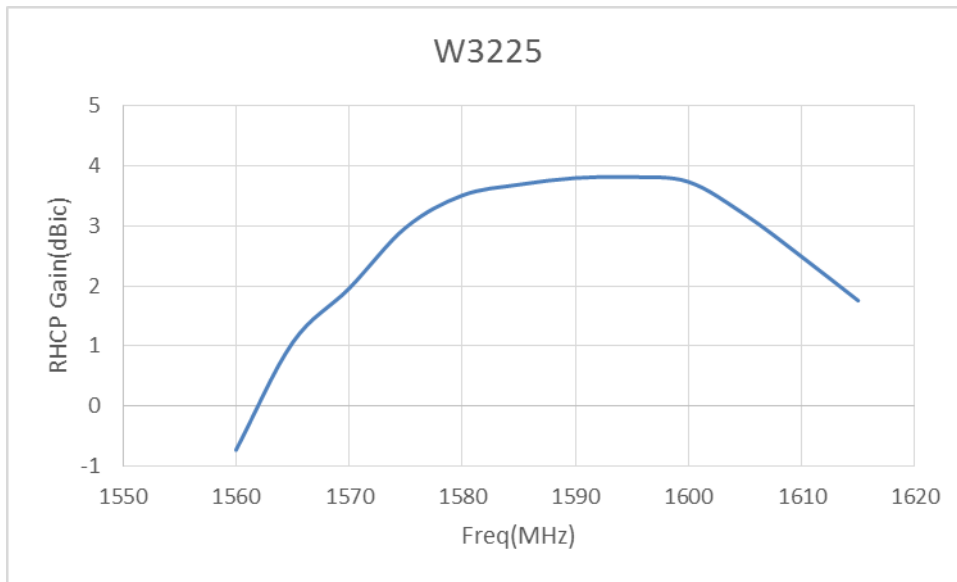

Zenith RHCP Gain

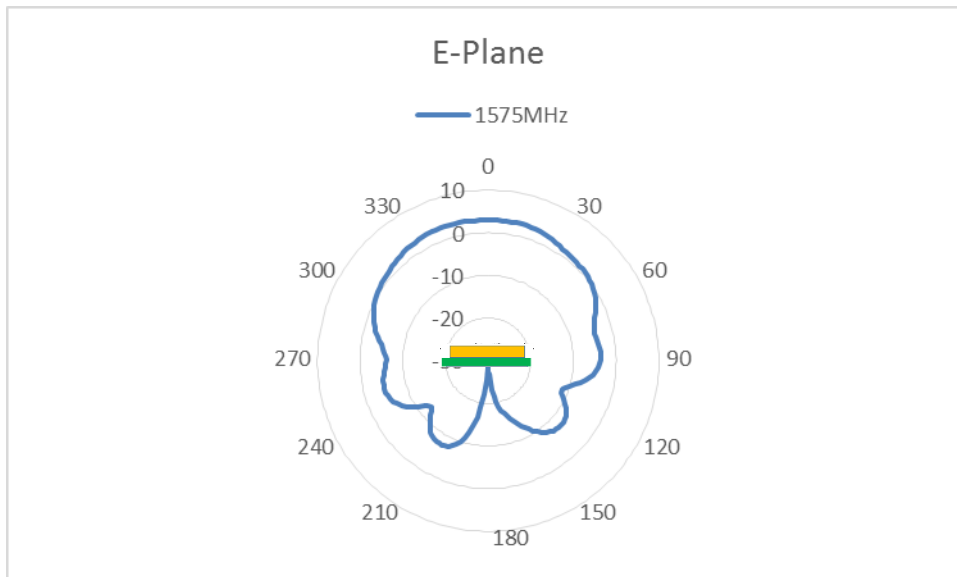

GPS Radiation pattern on 70mmX70mm metal plane

Issue: 1652

In the effort to improve our products, we reserve the right to make changes judged to be necessary.

CONFIDENTIAL AND PROPRIETARY INFORMATION

This document contains confidential and proprietary information of Pulse Electronics, Inc. (Pulse) and is protected by copyright, trade secret and other state and federal laws. Its receipt or possession does not convey any rights to reproduce, disclose its contents, or to manufacture, use or sell anything it may describe. Reproduction, disclosure or use without specific written authorization of Pulse is strictly forbidden.

Description: 25x25x4mm GPS/Glonass SMD Mount

Series: Ceramic Patch

PART NUMBER: W3225

CHARTS

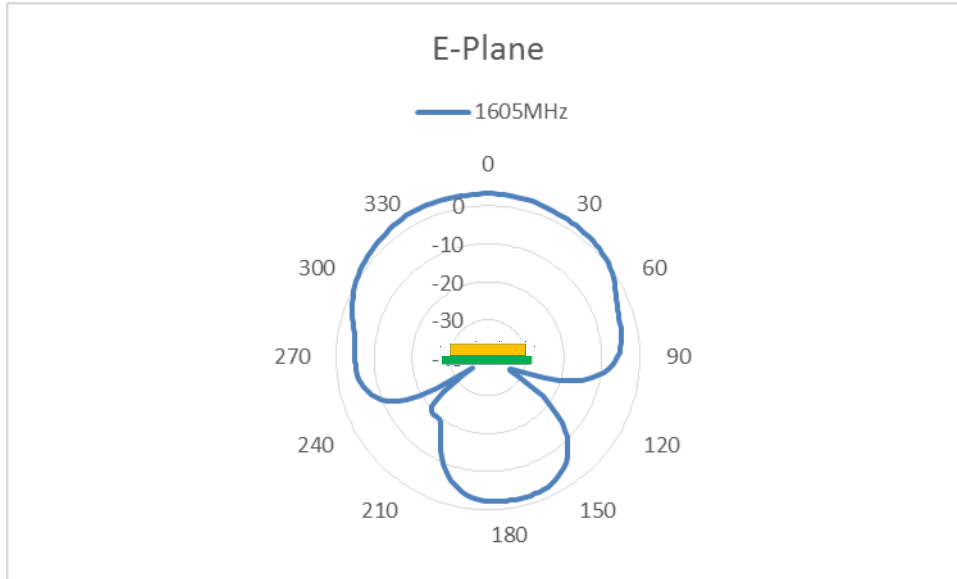

Glonass Radiation pattern on 70mmX70mm metal plane

Description: 25x25x4mm GPS/Glonass SMD Mount

Series: Ceramic Patch

PART NUMBER: W3225

PACKAGING

Tape packing
200PCS/reel

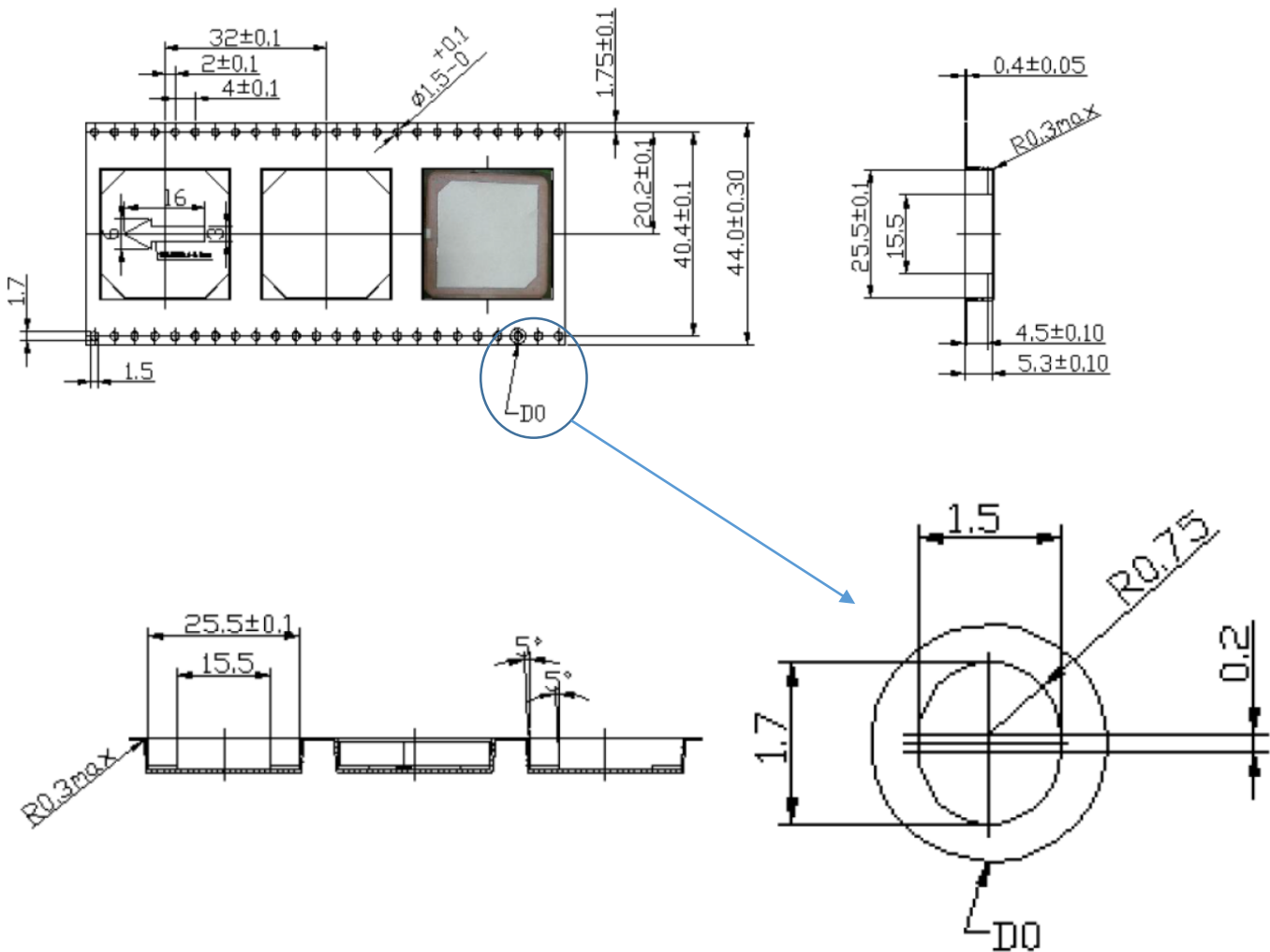

Issue: 1652

In the effort to improve our products, we reserve the right to make changes judged to be necessary.

CONFIDENTIAL AND PROPRIETARY INFORMATION

This document contains confidential and proprietary information of Pulse Electronics, Inc. (Pulse) and is protected by copyright, trade secret and other state and federal laws. Its receipt or possession does not convey any rights to reproduce, disclose its contents, or to manufacture, use or sell anything it may describe. Reproduction, disclosure or use without specific written authorization of Pulse is strictly forbidden.

Description: 25x25x4mm GPS/Glonass SMD Mount

Series: Ceramic Patch

PART NUMBER: W3225

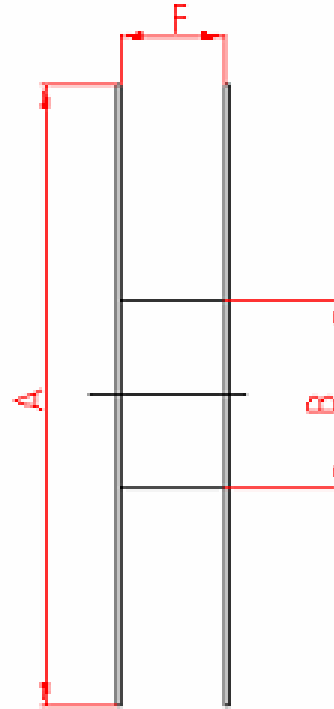
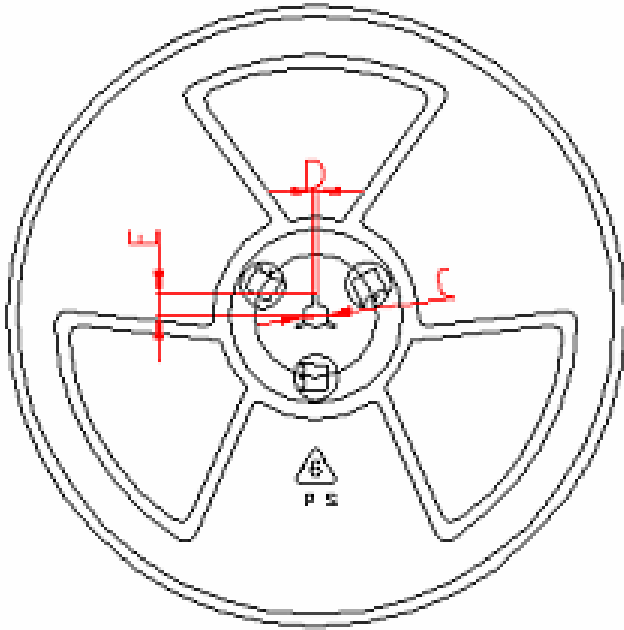

A	B	C	D	E	F
±2.0	±4.0	±0.2	±0.2	±0.25	±2.0
330	100	13.2	2	10.75	44.4

Issue: 1652

In the effort to improve our products, we reserve the right to make changes judged to be necessary.

CONFIDENTIAL AND PROPRIETARY INFORMATION

This document contains confidential and proprietary information of Pulse Electronics, Inc. (Pulse) and is protected by copyright, trade secret and other state and federal laws. Its receipt or possession does not convey any rights to reproduce, disclose its contents, or to manufacture, use or sell anything it may describe. Reproduction, disclosure or use without specific written authorization of Pulse is strictly forbidden.