

- **Designed for SDARS IF Receiver**
- **Low Insertion Loss**
- **5.0 X 7.0 mm Surface-Mount Case**
- **Differential or Single Ended Input and Output**
- **Complies with Directive 2002/95/EC (RoHS)**
- **Moisture Sensitivity Level: 1**
- **AEC-Q200 Qualified**

RoHS
Compliant

SF2038B

76.500 MHz
SAW Filter

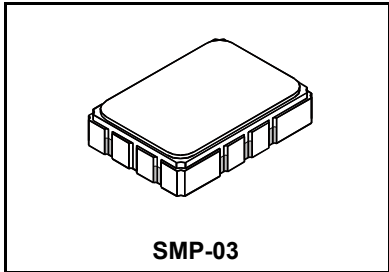

Absolute Maximum Ratings

Rating	Value	Units
Maximum Incident Power in Passband	+10	dBm
Max. DC voltage between any 2 terminals	30	VDC
Storage Temperature Range	-40 to +85	°C
Max Soldering Profile	265°C for 10 s	

Characteristic	Sym	Notes	Min	Typ	Max	Units	
Nominal Center Frequency	f_c			76.500		MHz	
Passband	Insertion Loss	IL		10.0	12.0	dB	
		1dB Passband	BW ₁	12.5	14.0	MHz	
		15dB Bandwidth	BW ₁₅		16.8	18.0	MHz
		30dB Bandwidth	BW ₃₀		18.0	19.2	MHz
Amplitude Ripple over $f_c \pm 6.25$ MHz				0.70	1.3	dB _{P-P}	
Group Delay Variation over $f_c \pm 6.25$ MHz		GDV		40	150	ns _{P-P}	
Rejection	50 to 64.44 MHz		40	46		dB	
		64.44 to 66.70 MHz	36	41			
		66.70 to 68.96 MHz					
		68.96 to 71.22 MHz					
		71.22 to 73.48 MHz					
	73.48 to 75.74 MHz		*30	44			
	75.74 to 78.00 MHz		36	44			
	78.00 to 80.26 MHz		40	47			
Operating Temperature Range	T _A		-40		+85	°C	
Frequency Coefficient	FTC			-87		ppm/°C	
Differential Input			175 ohms				
Differential Output			180 ohms				
Case Style			SMP-03 7 x 5 mm Nominal Footprint				
Lid Symbolization (YY=year, WW=week, S=shift)			RFM, SF2038B, YYWWS				

*At low temperature extreme -40°C

Electrical Connections

Connection	Terminals
Port 1 Hot	10
Port 1 Ground Return	1
Port 2 Hot	5
Port 2 Ground Return	6
Case Ground	All Others



CAUTION: Electrostatic Sensitive Device. Observe precautions for handling.

NOTES:

- 1. The design, manufacturing process, and specifications of this device are subject to change.
- 2. US or International patents may apply.
- 3. RoHS compliant from the first date of manufacture.

Matching Circuit and Matching Component Values Used in G3 Sirius Radios

(Refer to Sirius Radio G3 Chipset Application Note, Doc. #RX000104-B, Sec. 4.2.2)

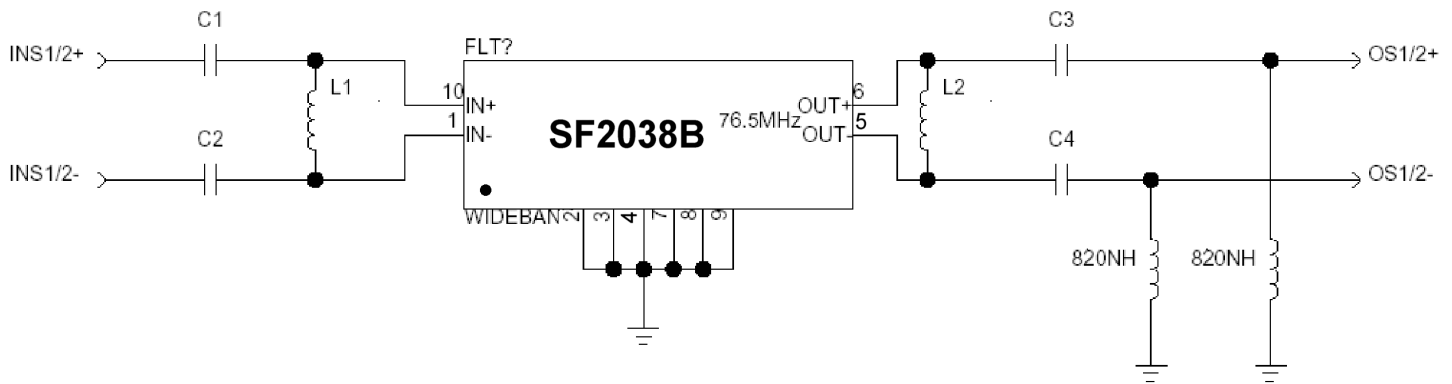

Wideband SAW Matching Circuit

Wideband SAW Matching Values

Reference Designator	Value
C1	15 pF
C2	15 pF
L1	270 nH
L2	270 nH
C3	27 pF
C4	27 pF

Matching Circuit and Matching Component Values Used on Filter Demo Board

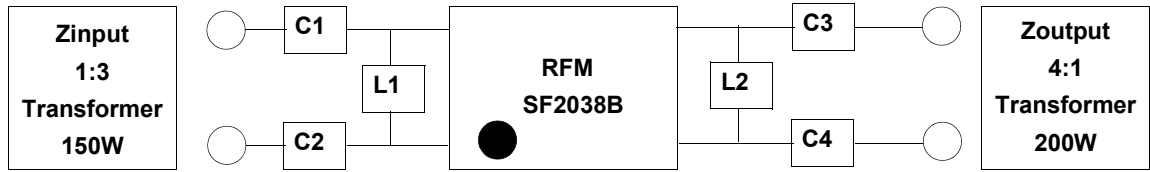

SF2038B
76.500 MHz

C1 = 22pF
C2 = 22pF
L1 = 220nH
L2 = 270nH
C3 = 22pF
C4 = 22pF

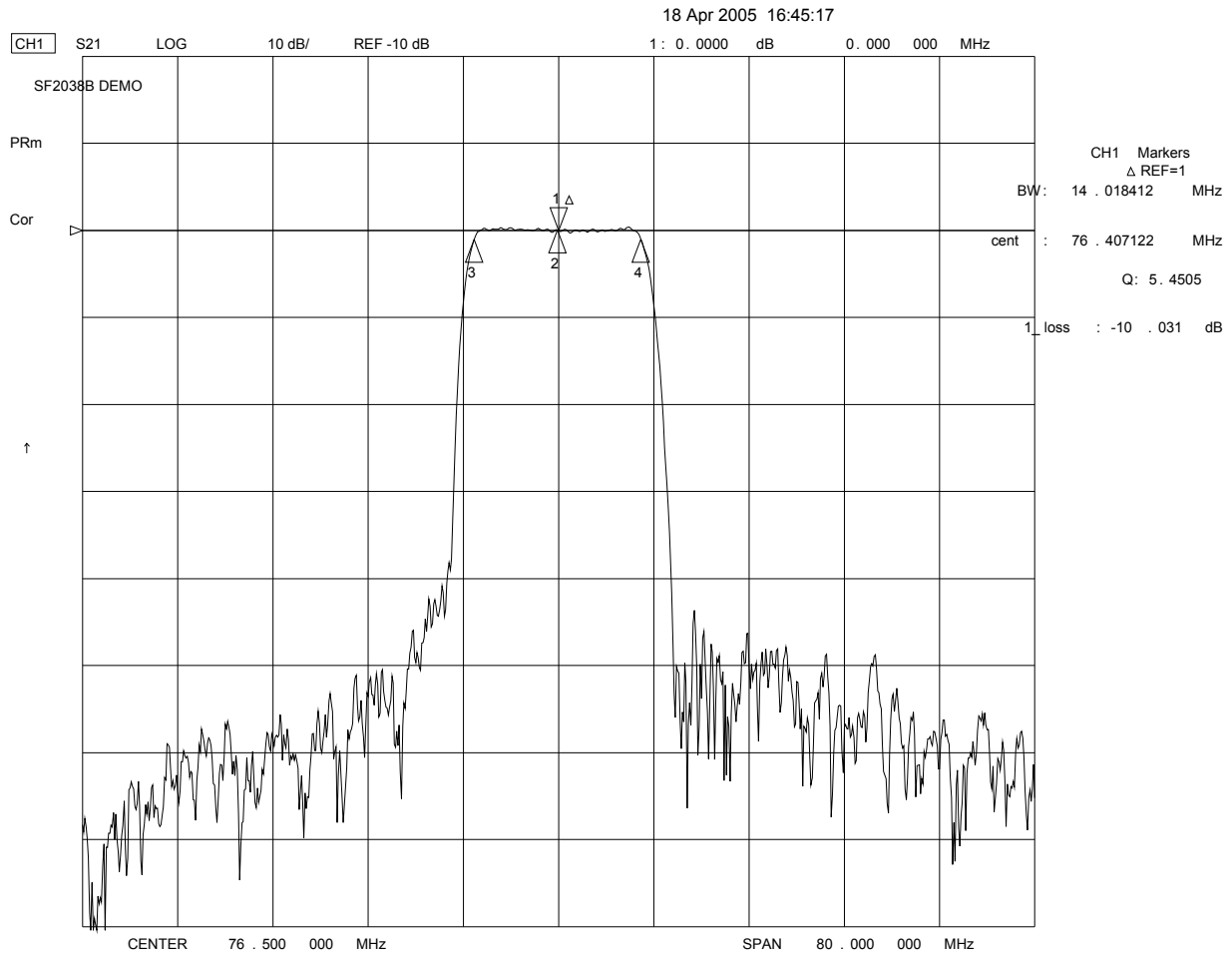

18 Apr 2005 16:42:05

CH1 S21 LOG 1 dB/ REF -10.4 dB 2 :- .29950 dB 12 .722 641 MHz

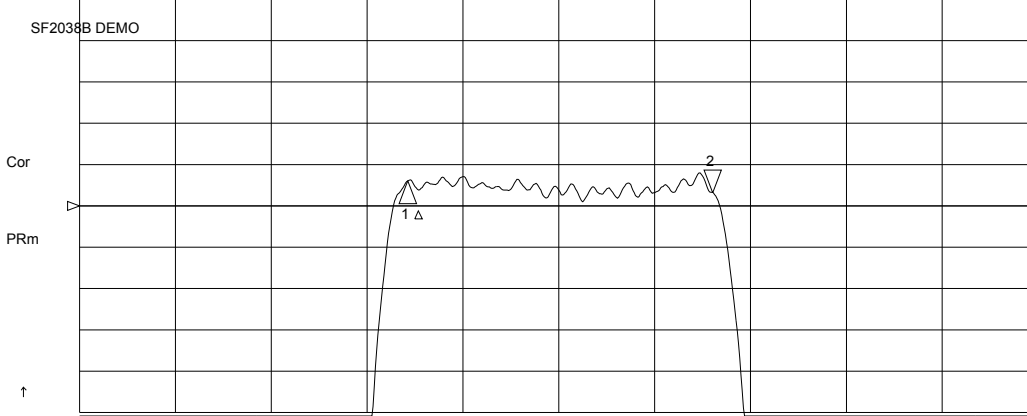

CH1 Markers
Δ REF=1
mean : -9 .9489 dB
s. dev : .13250 dB
p-p : .69240 dB

CH2 S21 DEL 50 ns/ REF 640 ns 2 :-31 .395 ns 12 .500 000 MHz

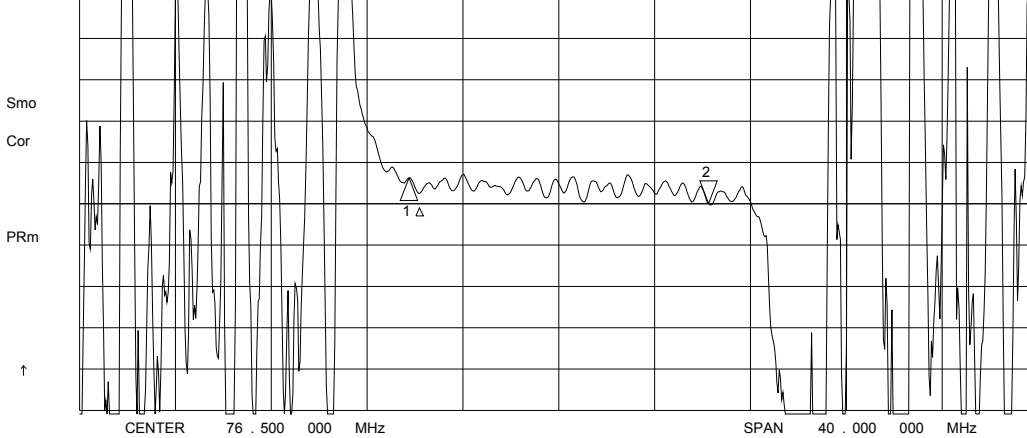

CH2 Markers
Δ REF=1
mean : 659 .90 ns
s. dev : 7 .6786 ns
p-p : 35 .477 ns

18 Apr 2005 16:35:10

CH1 S11 1 UFS

1: 44.537 Ω 19.910 Ω 41.422 nH 76.500 000 MHz

SF2038B DEMO

Cor

PRm

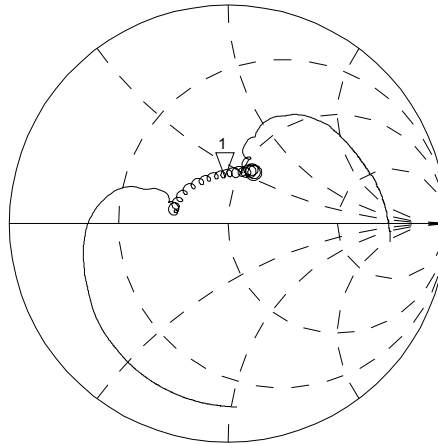

CH2 S22 1 UFS

1: 53.521 Ω 19.055 Ω 39.642 nH 76.500 000 MHz

Cor

PRm

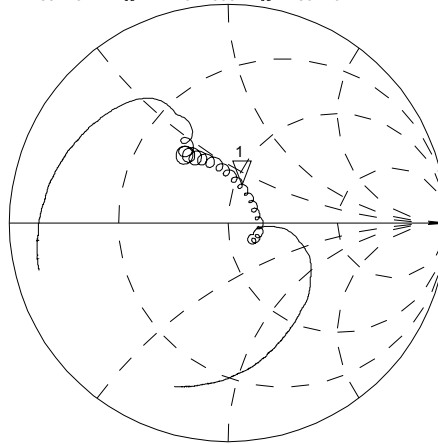

CENTER 76.500 000 MHz

SPAN 40.000 000 MHz

SMP-03 Case

10-Terminal Ceramic Surface-Mount Case

7 x 5 mm Nominal Footprint

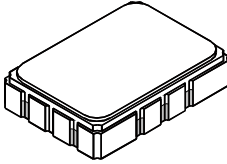

Recommended PCB Footprint

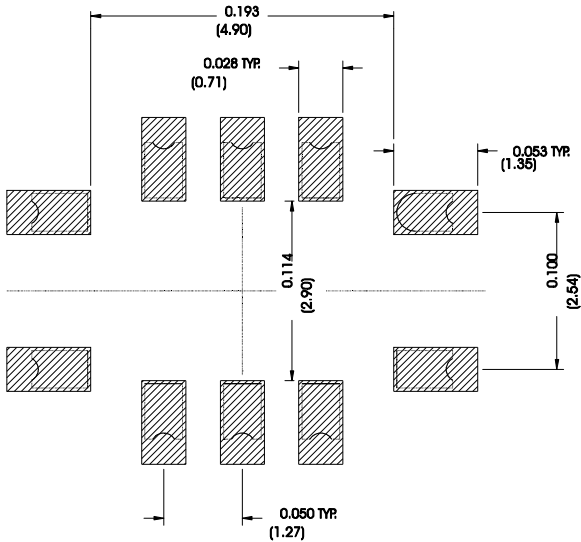

Case Dimensions						
Dimension	mm			Inches		
	Min	Nom	Max	Min	Nom	Max
A	6.80	7.00	7.20	0.268	0.276	0.283
B	4.80	5.00	5.20	0.189	0.197	0.205
C		1.65	2.00		0.065	0.079
D	.47	0.60	.73	0.019	0.024	0.029
E	2.41	2.54	2.67	0.095	0.100	0.105
H	0.87	1.0	1.13	0.034	0.039	0.044
J	4.87	5.00	5.13	0.192	0.197	0.202
K	2.87	3.00	3.13	0.113	0.118	0.123
P	1.14	1.27	1.40	0.045	0.050	0.055

Materials	
Solder Pad Termination	Au plating 30 - 60 ulnches (76.2-152 uM) over 80-200 ulnches (203-508 uM) Ni.
Lid	Fe-Ni-Co Alloy Electroless Nickel Plate (8-11% Phosphorus) 100-200 ulnches Thick
Body	Al ₂ O ₃ Ceramic

Electrical Connections		
	Connection	Terminals
Port 1	Input or Return	10
	Return or Input	1
Port 2	Output or Return	5
	Return or Output	6
	Ground	All others
Single Ended Operation		Return is ground
Differential Operation		Return is hot

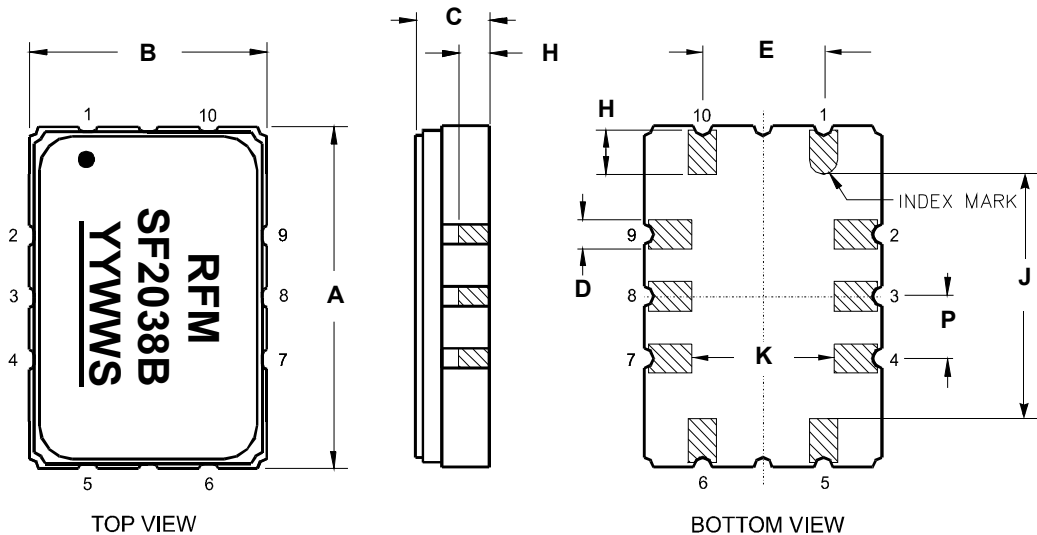

Tape and Reel Specifications

Tape and Reel Standard per ANSI/EIA-481

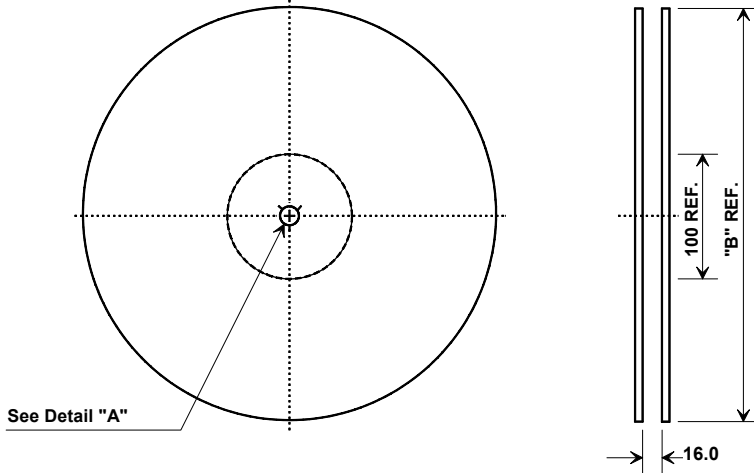

"B" Nominal Size		Quantity Per Reel
Inches	millimeters	
7	178	500
13	330	2000

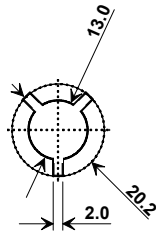

COMPONENT ORIENTATION and DIMENSIONS

Carrier Tape Dimensions	
Ao	5.5 mm
Bo	7.5 mm
Ko	2.0 mm
Pitch	8.0 mm
W	16.0 mm

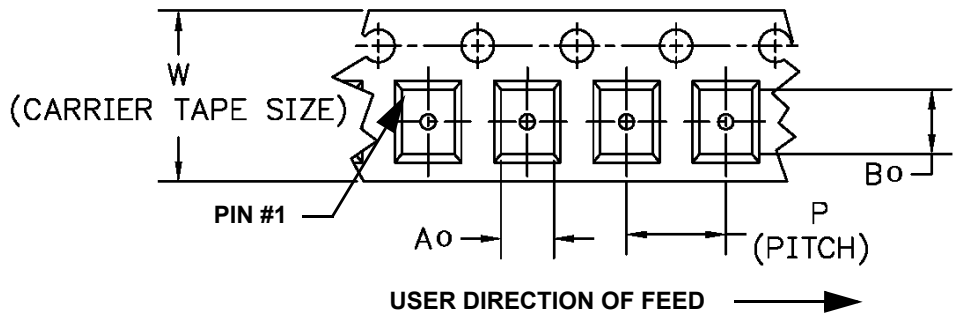
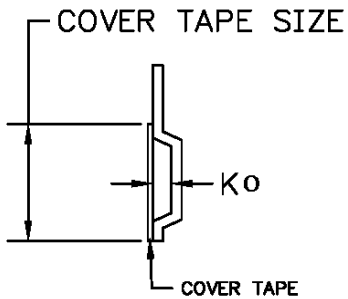

Recommended Reflow Profile

1. Preheating shall be fixed at 150~180°C for 60~90 seconds.
2. Ascending time to preheating temperature 150°C shall be 30 seconds min.
3. Heating shall be fixed at 220°C for 50~80 seconds and at 260°C+0/-5°C peak (10 seconds).
4. Time: 5 times maximum.

