



# WSE16P-34162100A00

W16

SMALL PHOTOELECTRIC SENSORS

**SICK**  
Sensor Intelligence.



Illustration may differ

### Ordering information

Type	Part no.
WSE16P-34162100A00	1088330

Other models and accessories → [www.sick.com/W16](http://www.sick.com/W16)



### Detailed technical data

#### Features

<b>Device type</b>	Photoelectric sensors
<b>Sensor/ detection principle</b>	Through-beam photoelectric sensor
<b>Dimensions (W x H x D)</b>	20 mm x 55.7 mm x 42 mm
<b>Housing design (light emission)</b>	Rectangular
<b>Sensing range max.</b>	0 m ... 45 m
<b>Type of light</b>	Visible red light
<b>Light source</b>	PinPoint LED <sup>1)</sup>
<b>Light spot size (distance)</b>	Ø 90 mm (8 m)
<b>Wave length</b>	635 nm
<b>Adjustment</b>	
	IO-Link For configuring the sensor parameters and Smart Task functions
	Wire/pin For activating the test input
<b>Indication</b>	
	LED blue BluePilot: Alignment aid
	LED green Operating indicator Static: power on Flashing: IO-Link mode
	LED yellow Status of received light beam Static: object not present

<sup>1)</sup> Average service life: 100,000 h at T<sub>U</sub> = +25 °C.

	Static off: object present Flashing: Below the 1.5 function reserve
<b>Pin 2 configuration</b>	External input, Teach-in, switching signal

<sup>1)</sup> Average service life: 100,000 h at  $T_U = +25 \text{ °C}$ .

## Mechanics/electronics

<b>Supply voltage</b>	10 V DC ... 30 V DC <sup>1)</sup>
<b>Ripple</b>	< 5 V <sub>pp</sub>
<b>Power consumption, sender</b>	≤ 30 mA <sup>2)</sup> < 50 mA <sup>3)</sup>
<b>Power consumption, receiver</b>	≤ 30 mA <sup>2)</sup> < 50 mA <sup>3)</sup>
<b>Switching output</b>	Push-pull: PNP/NPN
<b>Output: Q<sub>L1</sub> / C</b>	Switching output or IO-Link mode
<b>Output function</b>	Factory setting: Pin 2 / white (MF): NPN normally closed (light switching), PNP normally open (dark switching), Pin 4 / black (QL1 / C): NPN normally open (dark switching), PNP normally closed (light switching), IO-Link
<b>Switching mode</b>	Light/dark switching
<b>Signal voltage PNP HIGH/LOW</b>	Approx. $V_S - 2.5 \text{ V} / 0 \text{ V}$
<b>Signal voltage NPN HIGH/LOW</b>	Approx. $V_S / < 2.5 \text{ V}$
<b>Output current I<sub>max</sub></b>	≤ 100 mA
<b>Response time</b>	≤ 500 μs <sup>4)</sup>
<b>Switching frequency</b>	1,000 Hz <sup>5)</sup>
<b>Connection type</b>	Cable with M12 male connector, 4-pin, 270 mm <sup>6)</sup>
<b>Cable material</b>	PVC
<b>Circuit protection</b>	A <sup>7)</sup> B <sup>8)</sup> C <sup>9)</sup> D <sup>10)</sup>
<b>Protection class</b>	III
<b>Weight</b>	140 g
<b>Housing material</b>	Plastic, VISTAL®
<b>Optics material</b>	Plastic, PMMA
<b>Enclosure rating</b>	IP66 (According to EN 60529) IP67 (According to EN 60529) IP69 (According to EN 60529) <sup>11)</sup>

<sup>1)</sup> Limit values.

<sup>2)</sup> 16 V DC ... 30 V DC, without load.

<sup>3)</sup> 10 V DC ... 16 V DC, without load.

<sup>4)</sup> Signal transit time with resistive load in switching mode. Different values possible in COM2 mode.

<sup>5)</sup> With light/dark ratio 1:1 in switching mode. Different values possible in IO-Link mode.

<sup>6)</sup> Do not bend below 0 °C.

<sup>7)</sup> A =  $V_S$  connections reverse-polarity protected.

<sup>8)</sup> B = inputs and output reverse-polarity protected.

<sup>9)</sup> C = interference suppression.

<sup>10)</sup> D = outputs overcurrent and short-circuit protected.

<sup>11)</sup> Replaces IP69K with ISO 20653: 2013-03.

<b>Test input sender off</b>	Test at 0 V
<b>Ambient operating temperature</b>	-40 °C ... +60 °C
<b>Ambient temperature, storage</b>	-40 °C ... +75 °C
<b>UL File No.</b>	NRKH.E181493 & NRKH7.E181493

- 1) Limit values.
- 2) 16 V DC ... 30 V DC, without load.
- 3) 10 V DC ... 16 V DC, without load.
- 4) Signal transit time with resistive load in switching mode. Different values possible in COM2 mode.
- 5) With light/dark ratio 1:1 in switching mode. Different values possible in IO-Link mode.
- 6) Do not bend below 0 °C.
- 7) A = V<sub>S</sub> connections reverse-polarity protected.
- 8) B = inputs and output reverse-polarity protected.
- 9) C = interference suppression.
- 10) D = outputs overcurrent and short-circuit protected.
- 11) Replaces IP69K with ISO 20653: 2013-03.

### Safety-related parameters

<b>MTTF<sub>D</sub></b>	539 years
<b>DC<sub>avg</sub></b>	0 %

### Communication interface

<b>Communication interface</b>	IO-Link V1.1
<b>Communication Interface detail</b>	COM2 (38,4 kBaud)
<b>Cycle time</b>	2.3 ms
<b>Process data length</b>	16 Bit
<b>Process data structure</b>	Bit 0 = switching signal Q <sub>L1</sub> Bit 1 = switching signal Q <sub>L2</sub> Bit 2 ... 15 = empty
<b>VendorID</b>	26
<b>DeviceID HEX</b>	0x800174
<b>DeviceID DEC</b>	8388980

### Smart Task

<b>Smart Task name</b>	Base logics
<b>Logic function</b>	Direct AND OR Window Hysteresis
<b>Timer function</b>	Deactivated On delay Off delay ON and OFF delay Impulse (one shot)
<b>Inverter</b>	Yes
<b>Switching frequency</b>	SIO Direct: 1000 Hz <sup>1)</sup> SIO Logic: 800 Hz <sup>2)</sup> IOL: 650 Hz <sup>3)</sup>

<sup>1)</sup> SIO Direct: sensor operation in standard I/O mode without IO-Link communication and without using internal sensor logic or time parameters (set to "direct"/"deactivated").

<sup>2)</sup> SIO Logic: Sensor operation in standard I/O mode without IO-Link communication. Sensor-internal logic or timing parameters plus Automation Functions used.

<sup>3)</sup> IOL: Sensor operation with full IO-Link communication and usage of logic, timing and Automation Function parameters.

<b>Response time</b>	SIO Direct: 500 $\mu\text{s}$ <sup>1)</sup> SIO Logic: 600 $\mu\text{s}$ <sup>2)</sup> IOL: 750 $\mu\text{s}$ <sup>3)</sup>
<b>Repeatability</b>	SIO Direct: 150 $\mu\text{s}$ <sup>1)</sup> SIO Logic: 300 $\mu\text{s}$ <sup>2)</sup> IOL: 400 $\mu\text{s}$ <sup>3)</sup>
<b>Switching signal</b>	
Switching signal Q <sub>L1</sub>	Switching output
Switching signal Q <sub>L2</sub>	Switching output

<sup>1)</sup> SIO Direct: sensor operation in standard I/O mode without IO-Link communication and without using internal sensor logic or time parameters (set to "direct"/"deactivated").

<sup>2)</sup> SIO Logic: Sensor operation in standard I/O mode without IO-Link communication. Sensor-internal logic or timing parameters plus Automation Functions used.

<sup>3)</sup> IOL: Sensor operation with full IO-Link communication and usage of logic, timing and Automation Function parameters.

## Diagnosis

<b>Status information</b>	
Device status	Yes
Quality of teach	Yes
Quality of run	Yes, Contamination display

## Classifications

<b>ECl@ss 5.0</b>	27270901
<b>ECl@ss 5.1.4</b>	27270901
<b>ECl@ss 6.0</b>	27270901
<b>ECl@ss 6.2</b>	27270901
<b>ECl@ss 7.0</b>	27270901
<b>ECl@ss 8.0</b>	27270901
<b>ECl@ss 8.1</b>	27270901
<b>ECl@ss 9.0</b>	27270901
<b>ECl@ss 10.0</b>	27270901
<b>ECl@ss 11.0</b>	27270901
<b>ETIM 5.0</b>	EC002716
<b>ETIM 6.0</b>	EC002716
<b>ETIM 7.0</b>	EC002716
<b>ETIM 8.0</b>	EC002716
<b>UNSPSC 16.0901</b>	39121528

### Connection diagram

Cd-392

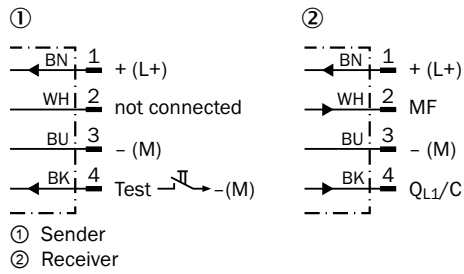

### Characteristic curve

WSE16P-xxxxx1xx, WSE16I-xxxxx1xx

Function reserve

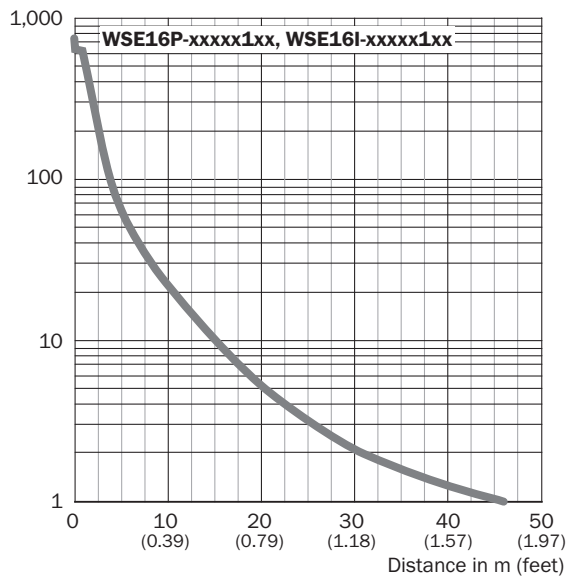

**Light spot size**

Visible red light

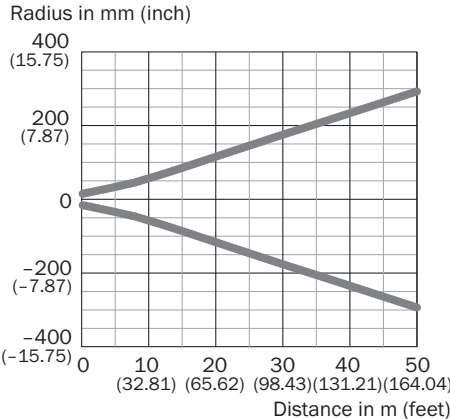

**WSE16P-xxxx1xx**  
**Sensing range diagram**

WSE16P-xxxx1xx, WSE16I-xxxx1xx

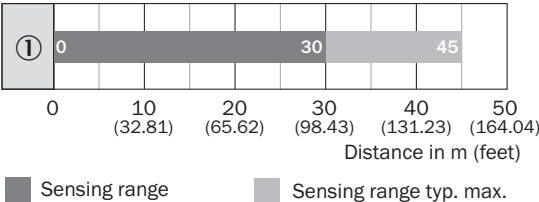

**Functions**

Operation note

**BluePilot: Blue indicator LEDs with double benefits**

Easy and quick sensor alignment with the help of the LED indicator

- All blue LEDs illuminate
  - optimum alignment
  - highest possible operating reserve

**WSE through-beam photoelectric sensor alignment**

**Service note**  
 A reduction in sensor availability is displayed by a decrease of the blue LEDs.

Possible causes:

- insufficient alignment
- contamination of the optical surfaces
- particles in the light beam

### Operation note

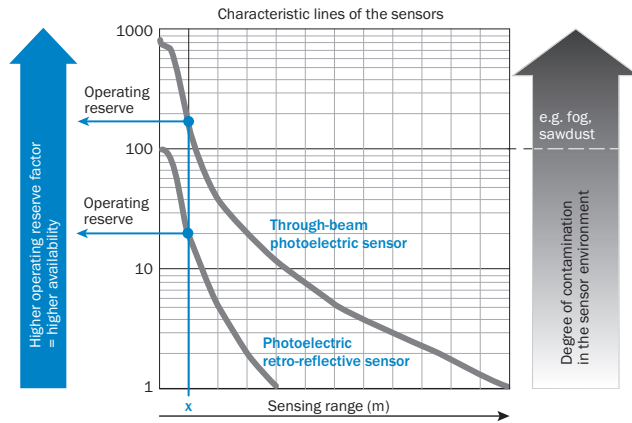

At a sensing range of „x“ the photoelectric retro-reflective and through-beam photoelectric sensors have different operating reserves (see blue arrow). The higher the operating reserve factor, the better the sensor can compensate the contamination in the air or in the light beam and on the optical surfaces (front screen, reflector), i.e. the sensor has the maximum availability, otherwise the sensor switches due to pollution although there is no object in the path of the light beam.

### Adjustments

#### Display and adjustment elements

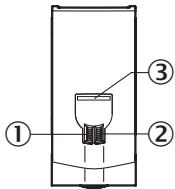

- ① LED indicator green
- ② LED indicator yellow
- ③ LED blue

### Dimensional drawing (Dimensions in mm (inch))

#### WSE16, cable

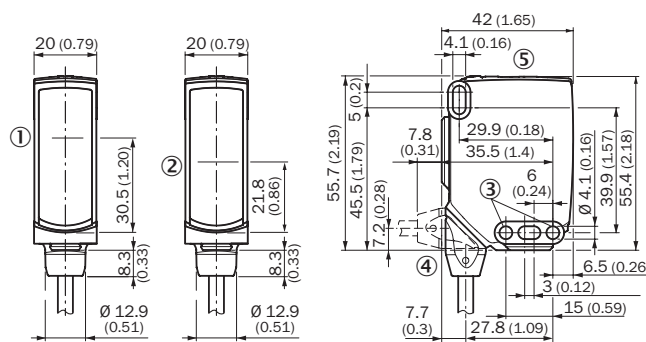





- ① Center of optical axis, sender
- ② Center of optical axis, receiver
- ③ Mounting hole,  $\varnothing$  4.1 mm
- ④ Connection
- ⑤ Display and adjustment elements



## Recommended accessories

Other models and accessories → [www.sick.com/W16](http://www.sick.com/W16)

	Brief description	Type	Part no.
Universal bar clamp systems			
	Plate N02 for universal clamp bracket, Zinc plated steel (sheet), Zinc die cast (clamping bracket), Universal clamp (5322626), mounting hardware	BEF-KHS-N02	2051608
Mounting brackets and plates			
	Adapter for mounting W16 sensors in existing W14-2/W18-3 installations or L25 sensors in existing L28 installations, plastic, fastening screws included	BEF-AP-W16	2095677
Plug connectors and cables			
	Head A: female connector, M12, 4-pin, straight, A-coded Head B: Flying leads Cable: Sensor/actuator cable, PVC, unshielded, 5 m	YF2A14-050VB3XLEAX	2096235
	Head A: male connector, M12, 4-pin, straight Head B: - Cable: unshielded	STE-1204-G	6009932

## Recommended services

Additional services → [www.sick.com/W16](http://www.sick.com/W16)

	Type	Part no.
Function Block Factory		
<ul style="list-style-type: none"> <li><b>Description:</b> The Function Block Factory supports common programmable logic controllers (PLCs) from various manufacturers, such as Siemens, Beckhoff, Rockwell Automation and B&amp;R. More information on the FBF can be found <a href="https://fbf.cloud.sick.com">here</a>.</li> </ul>	Function Block Factory	On request

## SICK AT A GLANCE

SICK is one of the leading manufacturers of intelligent sensors and sensor solutions for industrial applications. A unique range of products and services creates the perfect basis for controlling processes securely and efficiently, protecting individuals from accidents and preventing damage to the environment.

We have extensive experience in a wide range of industries and understand their processes and requirements. With intelligent sensors, we can deliver exactly what our customers need. In application centers in Europe, Asia and North America, system solutions are tested and optimized in accordance with customer specifications. All this makes us a reliable supplier and development partner.

Comprehensive services complete our offering: SICK LifeTime Services provide support throughout the machine life cycle and ensure safety and productivity.

For us, that is “Sensor Intelligence.”

## WORLDWIDE PRESENCE:

Contacts and other locations –[www.sick.com](http://www.sick.com)