

UG132: CPT007B SLEXP8007A Kit User's Guide

The CPT007 Capacitive Sense Evaluation Board is an excellent starting point to get familiar with Capacitive Sense touch pads.

The device serves as a user input peripheral for application development. The device can be configured for different touch sense capabilities and also contains easy access breakout pads and other peripherals for user feedback.

The kit includes the following:

- CPT007B Capacitive Sense Evaluation Board
- Getting Started card
- 1 x mini USB cable
- 1 x acrylic overlay

KEY FEATURES

- CPT007B Capacitive Sense device with GPIO
- 20-pin expansion header for connection with a Silicon Labs Starter Kit (EFM8 or EFM32)
- Breakout test points for easy access to touch pads
- Power sources include USB and EXT Header
- 7 Capacitive Sense touch pads, 7 LEDs
- 1 Buzzer

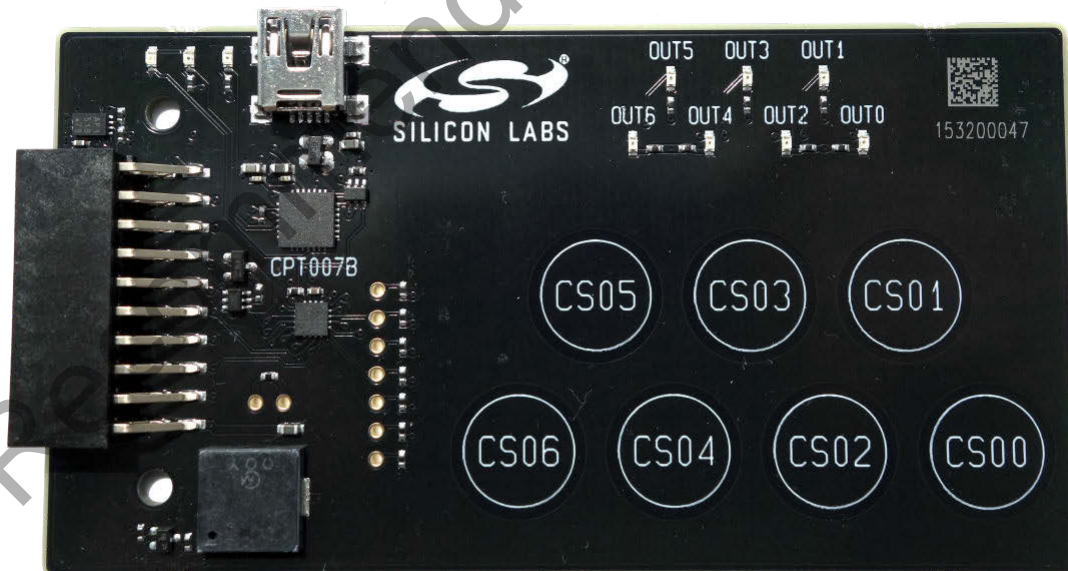

1. Getting Started

Hardware

To set up the hardware for the CPT007B SLEXP8007A kit:

1. Provide power to the board by connecting the DBG USB connector to the PC using the provided USB cable. When a connection has been established successfully, the LED (marked in the picture) lights up.
2. Place the acrylic overlay on the board over the capacitive sense pads.

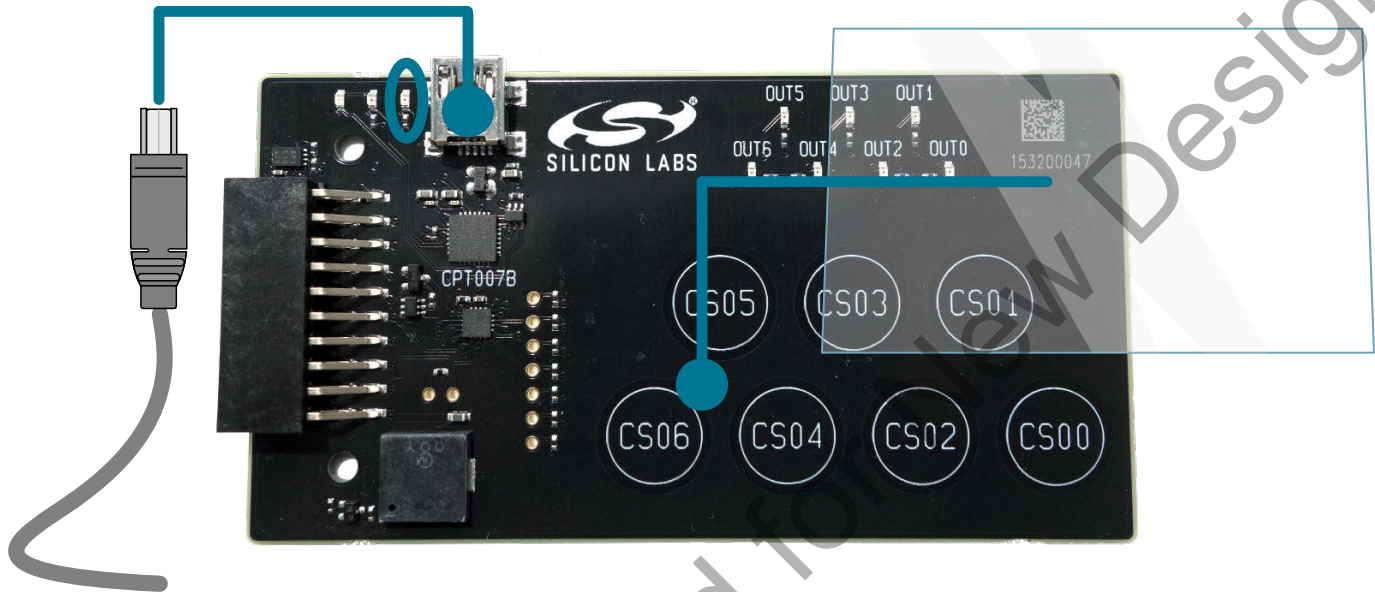

Figure 1.1. Hardware Setup

Software

The first step to get started with your new CPT007B SLEXP8007A kit is to go to

<http://www.silabs.com/simplicity>

The Simplicity Studio software package contains all the tools, drivers, software examples, and documentation needed to use the CPT007B Capacitive Sense Evaluation Board. The board comes preconfigured for a Touch Demo for use with the acrylic overlay. The demo enables the board to recognize touch events and touch release events. Every time a touch is sensed, the paired digital output pin will go high, the corresponding LED will light up, and the buzzer will sound.

After downloading the latest version of Simplicity Studio and installing the software:

1. The auto-detect feature in Simplicity Studio can cause a CPT device to miss touches. First disable automatic detection by clicking the **[Settings]** icon, selecting **[Device Manager]>[TCF Device Discovery]**, and selecting **[Never]** for **[USB Discovery Options]**. Click **[OK]**.
2. Click the **[Refresh detected hardware]** button.
3. Select **[CPT007B]** under **[Detected Hardware]**. On the board, a successful USB connection is established when the LED next to the USB connector turns on.
4. Click the **[Capacitive Sense Profiler]** tile. This utility graphs touch-related data and events received from the CPT007B SLEXP8007A for evaluation and analysis.

2. Kit Block Diagram

An overview of the CPT007B Capacitive Sense Evaluation Board is shown in the figure below.

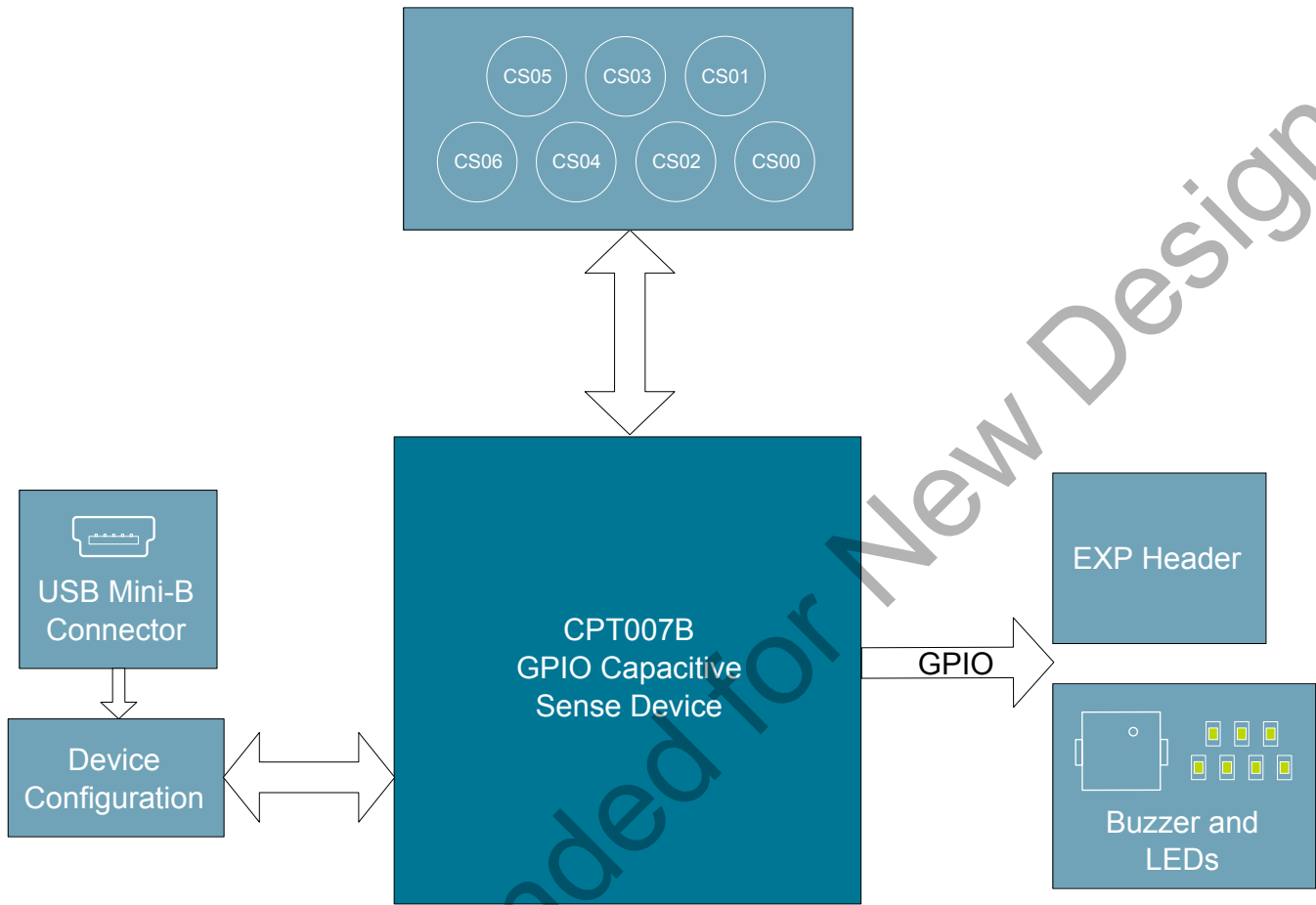

Figure 2.1. CPT007B SLEXP8007A Block Diagram

3. Kit Hardware Layout

The layout of the CPT007B Capacitive Sense Evaluation Board is shown below.

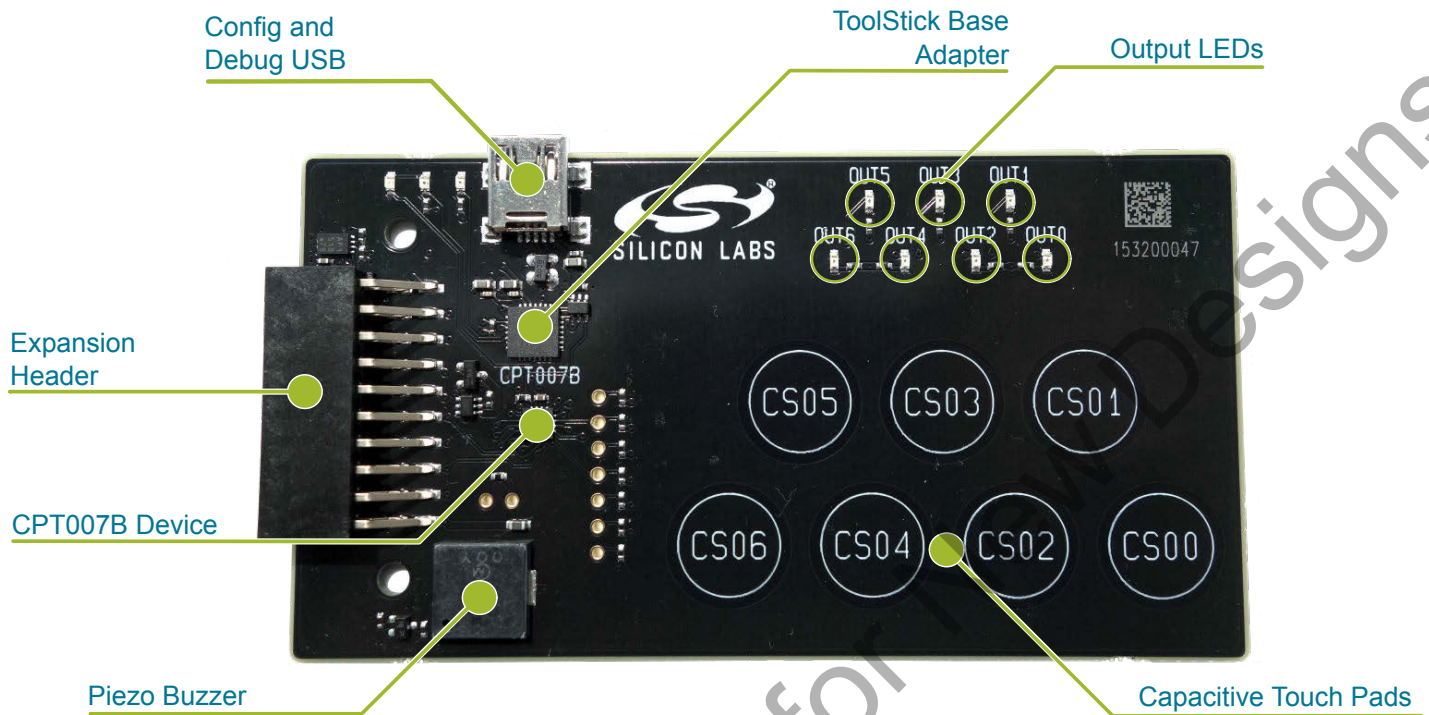

Figure 3.1. CPT007B SLEXP8007A Hardware Layout

The CPT007B device on the kit can be connected to external peripherals other than the assigned pin functions using the vias on the board. The table below shows all of the external connections to the fixed function CPT007B device.

Table 3.1. CPT007B Device Connections

CPT007B Pin	Assigned Function	Expansion Port Connection (EXP)
CS00	Capacitive Sense Pad CS00	—
CS01	Capacitive Sense Pad CS01	—
CS02	Capacitive Sense Pad CS02	—
CS03	Capacitive Sense Pad CS03	—
CS04	Capacitive Sense Pad CS04	—
CS05	Capacitive Sense Pad CS05	—
CS06	Capacitive Sense Pad CS06	—
BUZZER	Piezo Buzzer	—
OUT00	Output corresponding to CS00 and LED OUT0	EXP6
OUT01	Output corresponding to CS01 and LED OUT1	EXP10
OUT02	Output corresponding to CS02 and LED OUT2	EXP16

CPT007B Pin	Assigned Function	Expansion Port Connection (EXP)
OUT03	Output corresponding to CS03 and LED OUT3	EXP15
OUT04	Output corresponding to CS04 and LED OUT4	EXP5
OUT05	Output corresponding to CS05 and LED OUT5	EXP7
OUT06	Output corresponding to CS06 and LED OUT6	EXP9
RSTb / Config Clk	Configuration Clock	—
Config Data	Configuration Data	—

Not Recommended for New Designs

4. Power and Operation

4.1 Power Selection

The CPT007 Capacitive Sense Evaluation Board is designed to be powered by two different sources:

- Through the on-board USB.
- Through the EXP header.

The figure shows how the different power sources are connected to the device.

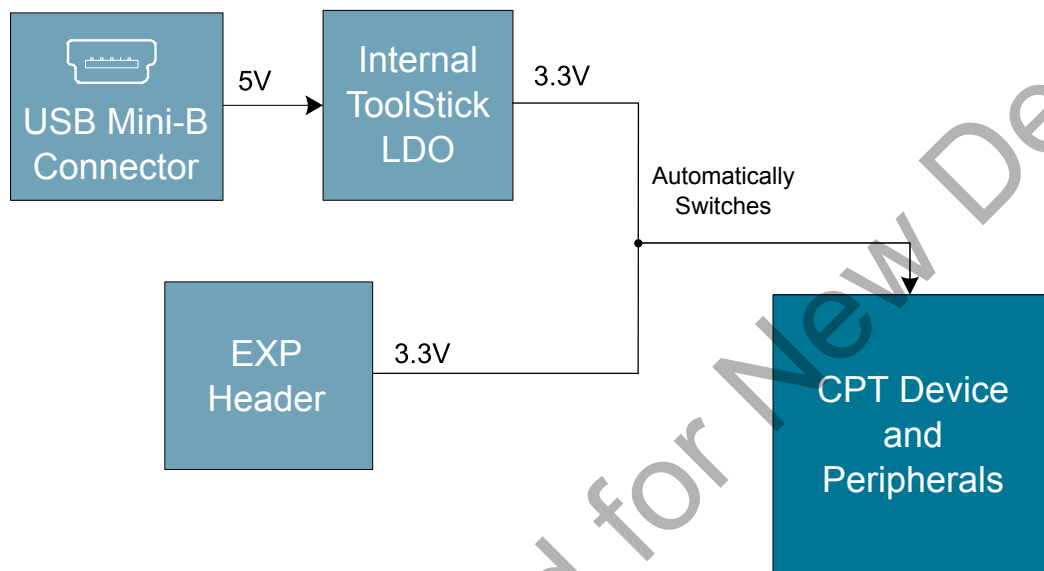

Figure 4.1. CPT007B SLEXP8007A Power Supply

When the USB is connected, the board is powered from the LDO internal to the USB device, which is in turn powered by the USB cable.

The board can also be powered externally through the VMCU and GND pins of the expansion header when the board is attached to a power supply or an EFM MCU Starter Kit.

When power is provided through the USB or an external power supply, the device can act as a stand alone device. When it is connected to an EFM MCU Starter Kit through the expansion header, the device acts as a peripheral to the MCU by providing capacitive sense capabilities.

4.2 Standalone

In standalone mode, the CPT007B SLEXP8007A on the CPT007 Capacitive Sense Evaluation Board is designed to showcase and test the board's features or act as a breakout board for any application. To operate in this mode, apply power using the USB connector or an external supply.

The board can operate on its own to demonstrate and test the board's touch features and functionalities. The CPT007B SLEXP8007A features configurable options such as touch characteristics, output characteristics, and user feedback peripherals. The device's features can be configured in Simplicity Studio using [**Xpress Configurator**], and the capacitive sense data can be viewed in the [**Capacitive Sense Profiler**].

The device can act as a breakout board to extend functionality of a custom board by simply reading the output results on the pins. The touch qualification engine on the device will process the touch information and output the results through GPIO. The device outputs can be accessed through the expansion header, and the capacitive sense inputs can be accessed through the vias on the board.

4.3 Connected to the Expansion Header

The CPT007 Capacitive Sense Evaluation Board is designed to quickly attach to any EFM32 and EFM8 MCU starter kit and jump-start the development of capacitive sense capable applications. Attach the CPT007 Capacitive Sense Evaluation Board to the STK through the expansion header to connect the power and communication pins.

To see how the board works in conjunction with the MCU starter kit, go to the starter kit's [Demos] under [Tools] in Simplicity Studio and run [CPT007B Demo].

For more details on the starter kit, see the corresponding starter kit's user guide.

Note: Not all EFM32 starter kits support this expansion board. See the available demos in Simplicity Studio for more information.

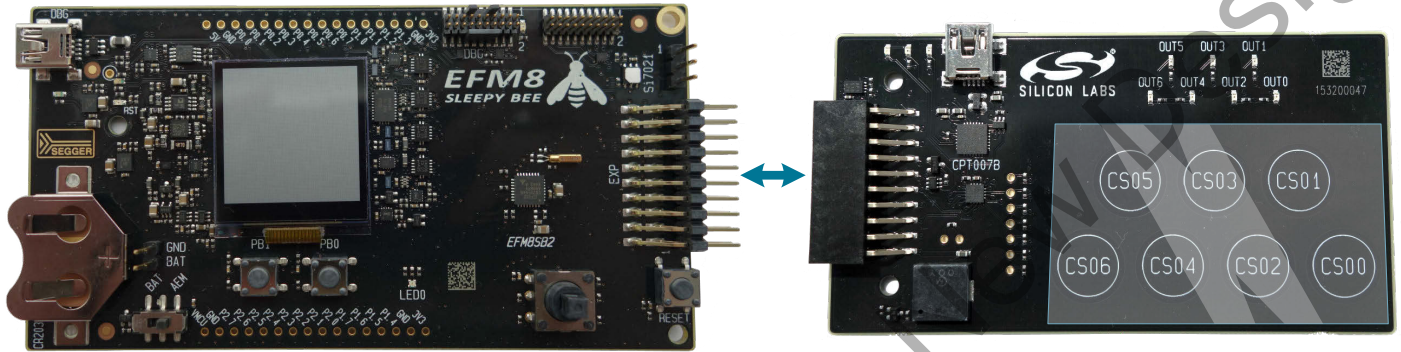

Figure 4.2. CPT007B SLEXP8007A Connected to an Example EFM8SB2 STK

5. Peripherals

The starter kit has a set of peripherals that showcase some of the features of the CPT007B device.

Be aware that some CPT007B I/O routed to peripherals are also routed to the breakout pads. This must be taken into consideration when using the breakout pads for your application.

5.1 Capacitive Sense Touch Pads

The kit has 7 capacitive sense touch pads. The touch pads are connected in order to pins CS00 - CS06 of the CPT007B SLEXP8007A. After the touch pad inputs have been processed by the touch qualification engine, the CPT007B SLEXP8007A will output the result through GPIO.

The capacitive sense inputs can be configured for different thresholds, debounce counter values, scan periods, gain, scanning methods, touch time-outs, and touch exclusiveness using the **[Xpress Configurator]** in Simplicity Studio. The device outputs can also be configured for different pin polarities and drive strength.

See the CPT007B SLEXP8007A Data Sheet for more detailed information on the different configurations.

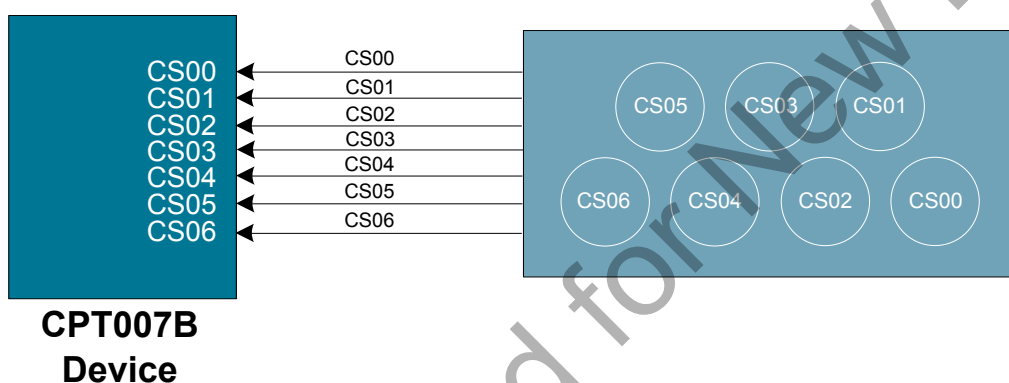

Figure 5.1. Capacitive Sense Touch Pads

5.2 LEDs and Buzzer

The device features LEDs and a buzzer to provide feedback to the user when using the device.

There are 7 LEDs located above the capacitive sense touch pads and corresponds 1-to-1 to the touch pads. The LEDs are connected to the CPT007B on the OUTn pins.

The board's buzzer is located to the bottom left of the board and is connected to the CPT007B on the BUZZER pin.

The LED and BUZZER outputs can be configured to be active or inactive when the touch pads are touched using Configurator.

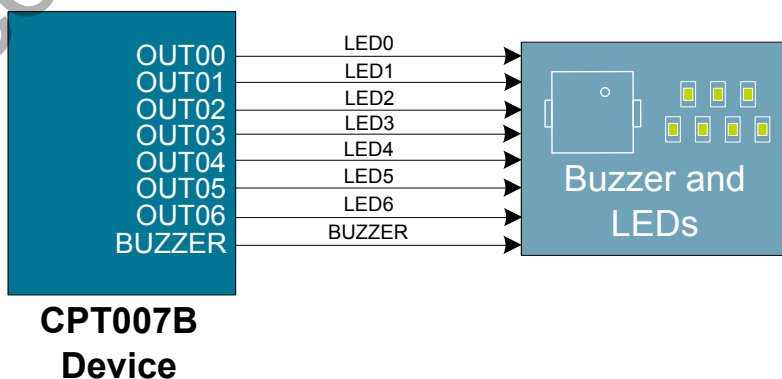

Figure 5.2. LEDs and Buzzer

6. Connectors

6.1 Breakout Pads

The "breakout pads" located on the left of the touch pads are routed to the capacitive sense input traces and power rails.

The capacitive sense input traces can be accessed through the vertically aligned vias located in middle of the board on the left of the pads. All 7 CPT007B capacitive sensing touch pads are bound to each via.

Furthermore, above the buzzer, there are two breakout pads for VMCU and GND to measure the active current of the board using an in-circuit ammeter. A 2.54 mm pitch pin header can be soldered in for easy access to these pins.

Note: In order for the capacitive sense pins to be connected properly to your application or power to be measured correctly, the 0 ohm resistors must be removed. The 0 ohm resistor for a channel can be found next to the corresponding via on the top side of the board.

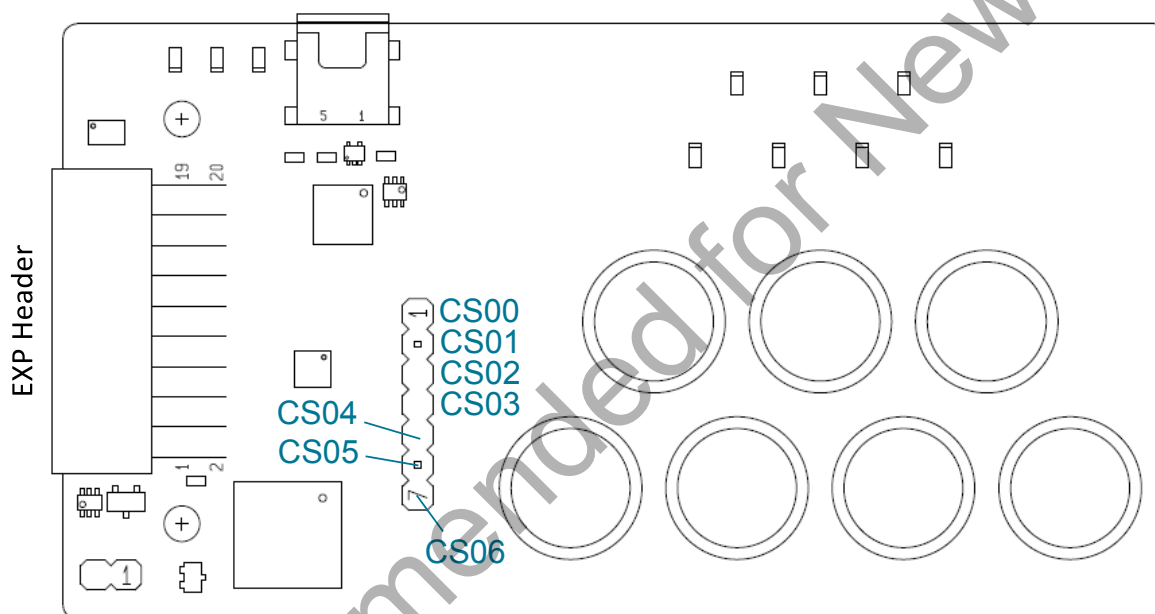

Figure 6.1. Breakout Pads

6.2 Expansion Header

On the left hand side of the board is a female expansion header to connect to a Silicon Labs EFM8 or EFM32 Starter Kit (STK). The connector contains a number of output and communication pins that can be used to communicate with the MCU on the STK. The results from the touch qualification engine are routed out to these pins. Additionally, the VMCU, 3V3, and 5V power rails are also imported. The figure below shows the pin assignment of the expansion header.

The CPT007B SLEXP8007A outputs using GPIO.

The pin assignment of the expansion header and the peripheral function are listed below in the figure and table.

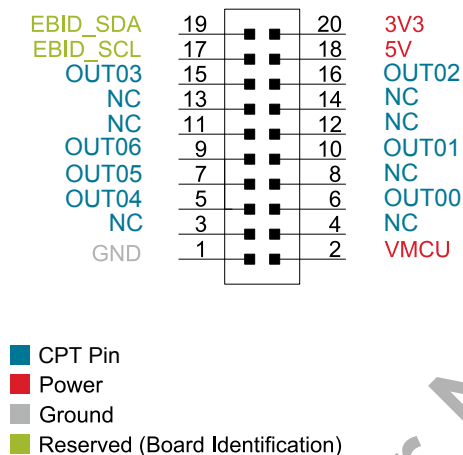

Figure 6.2. Expansion Header

Table 6.1. Pins available on Expansion Header

CPT007B pin	EXP Header pin number
OUT00	6
OUT01	10
OUT02	16
OUT03	15
OUT04	5
OUT05	7
OUT06	9

7. Simplicity Studio

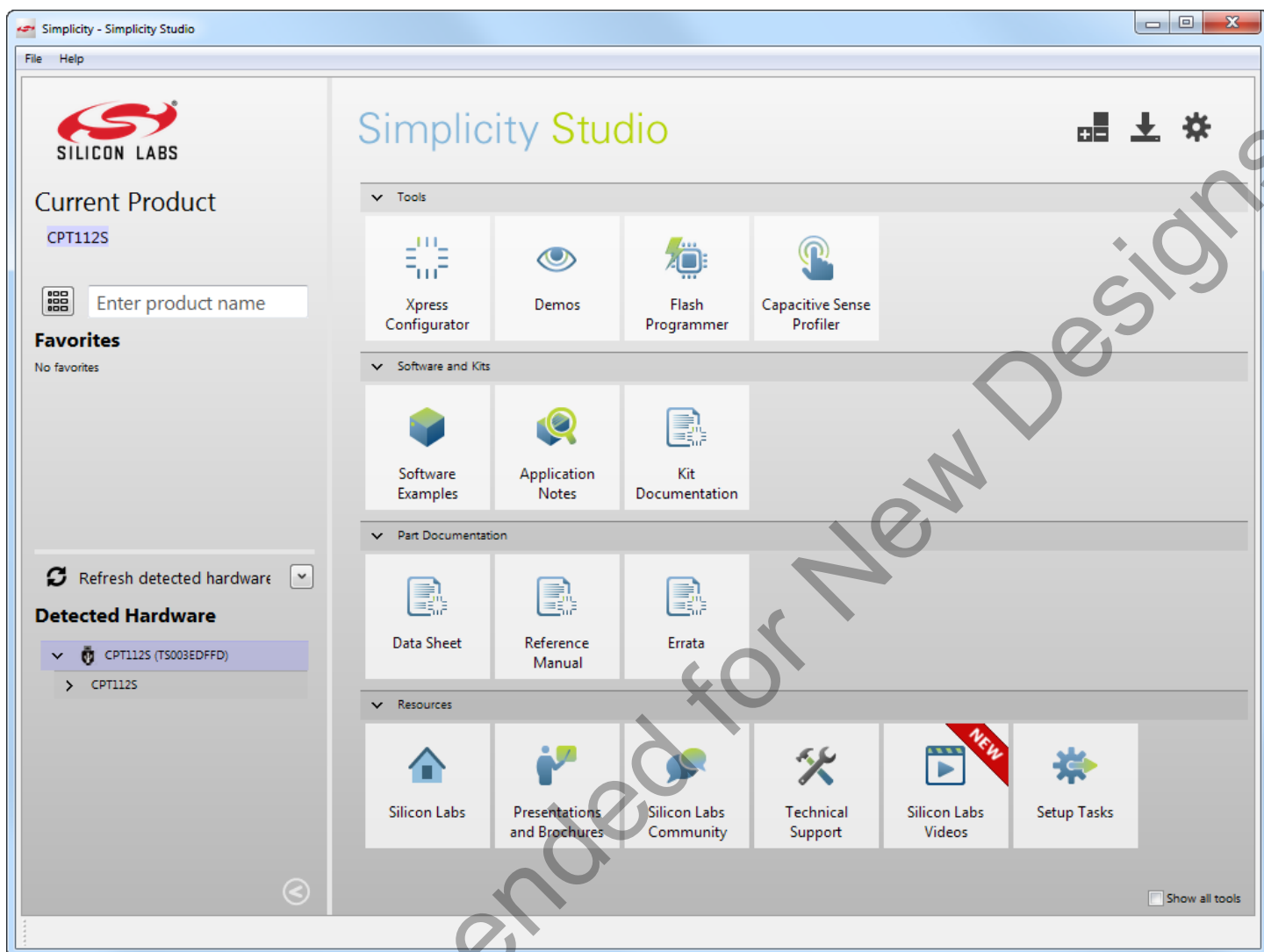

Figure 7.1. Simplicity Studio

7.1 Xpress Configurator

[Xpress Configurator] provides the necessary tools to modify the CPT007B SLEXP8007A's functionalities for a custom application in an easy-to-use GUI. To use [Xpress Configurator] within Simplicity Studio:

1. Provide power to the board by connecting the USB connector to the PC using the provided USB cable.
2. Click the [Refresh detected hardware] button and select [CPT007B] under [Detected Hardware].
3. Go to [Tools] and click the [Xpress Configurator] tile.
4. Select the desired configuration for the engine and peripherals.

More information about each of the options in [Xpress Configurator] is available in AN0829: "Capacitive Sensing Library Configuration Guide." Application notes can be accessed within Simplicity Studio using the [Application Notes] tile or on the Silicon Labs website (www.silabs.com/interface-annotes).

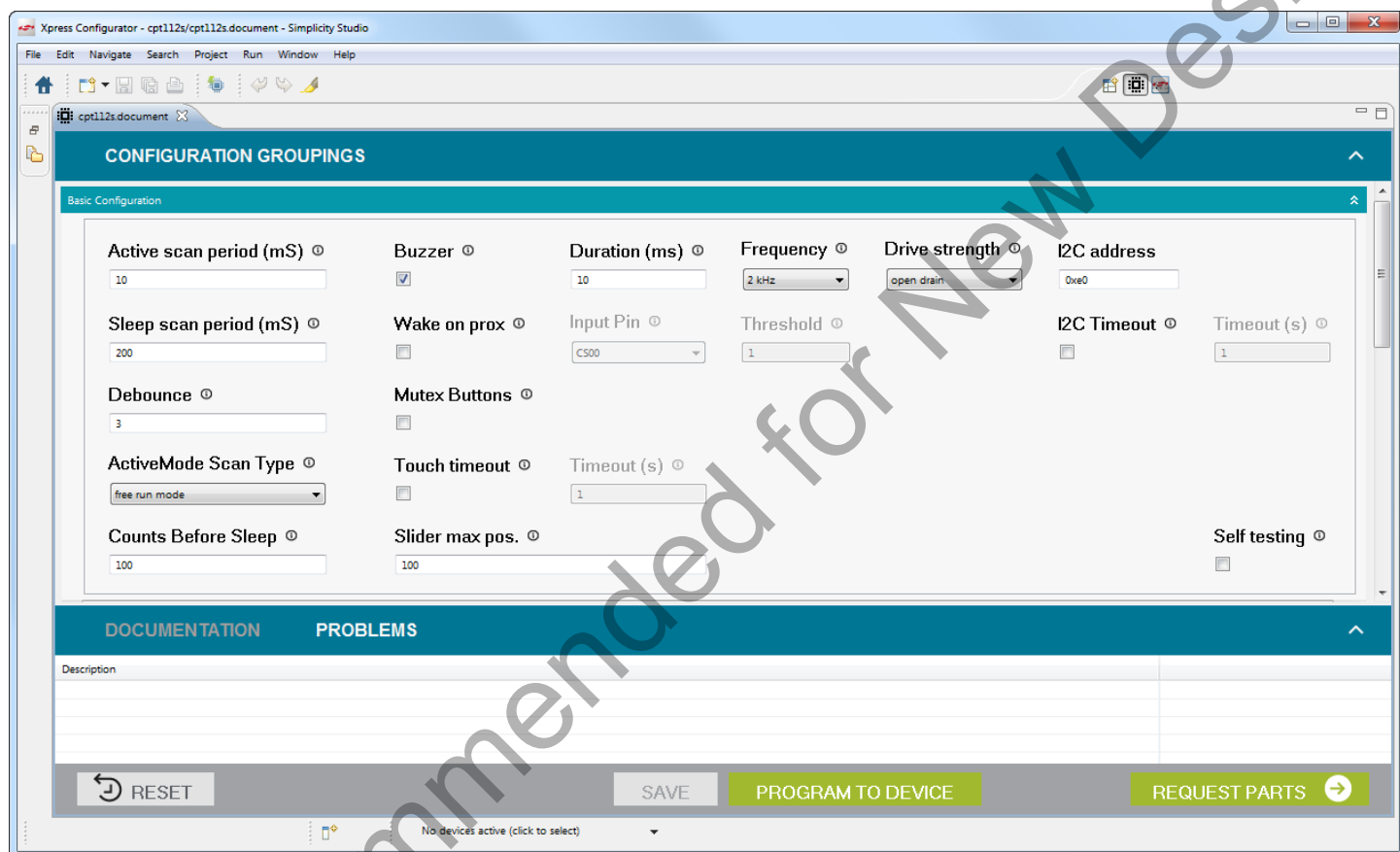

Figure 7.2. Simplicity Studio Xpress Configurator

7.2 Capacitive Sense Profiler

The [Capacitive Sense Profiler] in Simplicity Studio displays touches, raw and processed data, and noise information in a simple-to-use GUI. Touch and release any of the capacitive sensing peripherals on the board and the profiler will display the data in a table and as a graph over time.

To access and setup the [Capacitive Sense Profiler] in [Simplicity Studio]:

1. Provide power to the board by connecting the USB connector to the PC using the provided USB cable.
2. Click the [Refresh detected hardware] button and select the [CPT007B] kit under [Detected Hardware].
3. Go to [Tools] and select the [Capacitive Sense Profiler] tile.
4. In the [Control Panel], click [Use Device...].

Once the board is connected, touch and release any of the capacitive sensing touch peripherals on the board to view the raw and processed data. The profiler can view the data as [Raw Data], [Noise], and [Buttons]. The Buttons view is particularly useful since it shows the state of the capacitive sense touch pads as either on or off.

More information about [Capacitive Sense Profiler] is available in AN0829: "Capacitive Sensing Library Configuration Guide." Application notes can be accessed within Simplicity Studio using the [Application Notes] tile or on the Silicon Labs website (www.silabs.com/interface-appnotes).

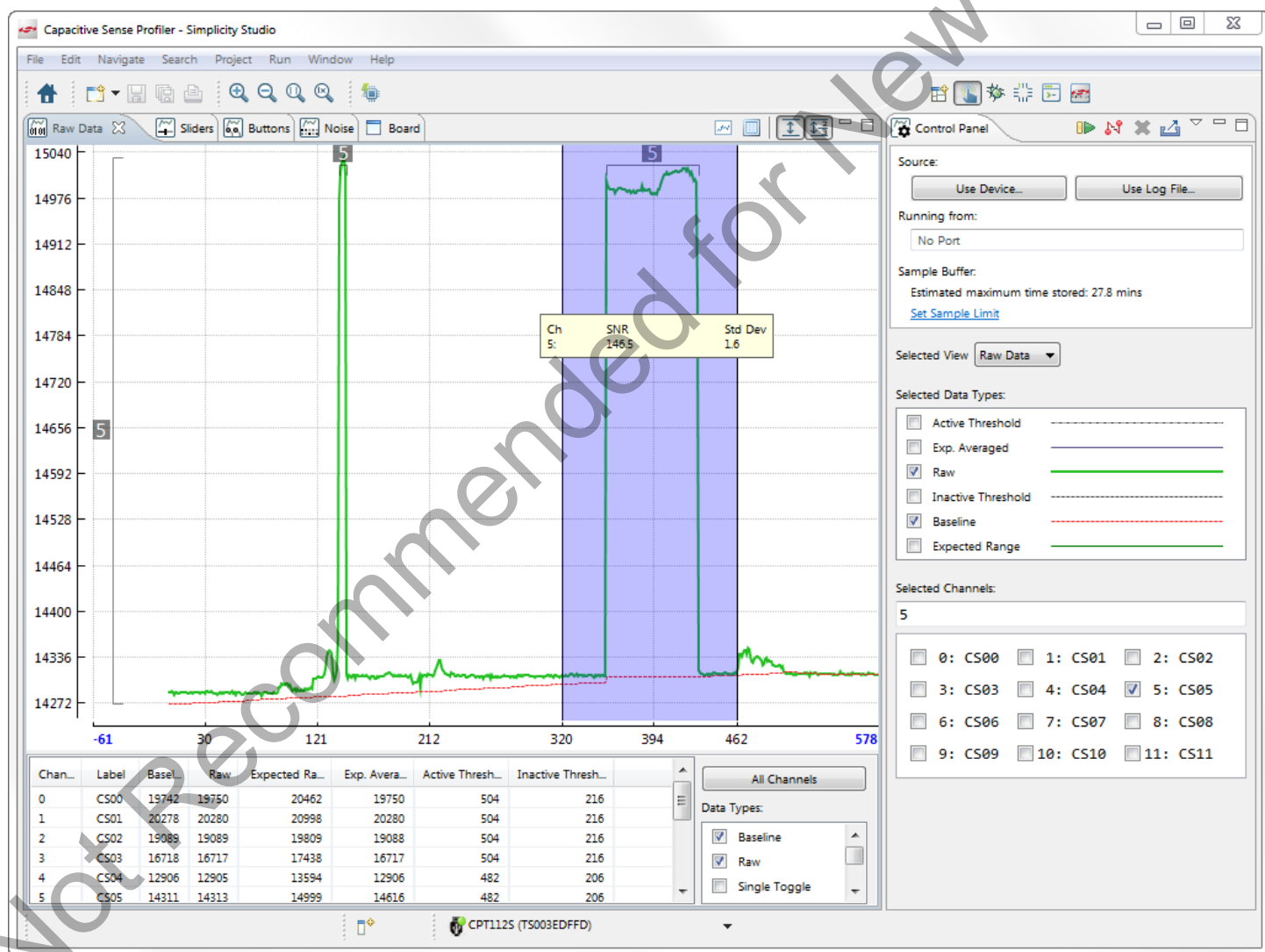

Figure 7.3. Simplicity Studio Capacitive Sense Profiler

8. Advanced Energy Monitor

When the CPT007B Capacitive Sense Evaluation Board is connected to a Silicon Labs STK, the STK's AEM (Advanced Energy Monitor) hardware also measures the CPT007B power consumption using the VMCU connection on the EXP header. By using the [Energy Profiler] in Simplicity Studio, current consumption and voltage can be measured in real time.

More details about AEM and its operation can be found in the STK User Guide. Note that AEM will measure the current for all circuitry connected to VMCU, including the STK MCU and the CPT device.

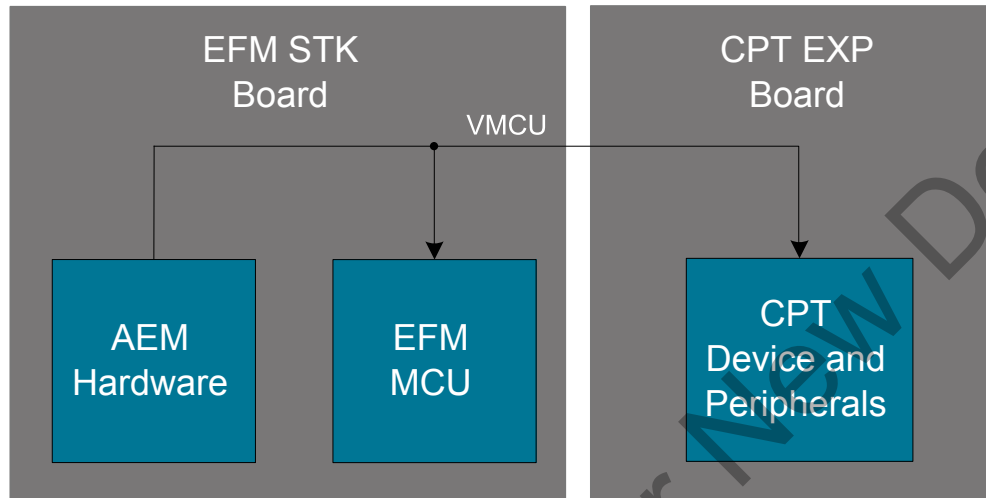
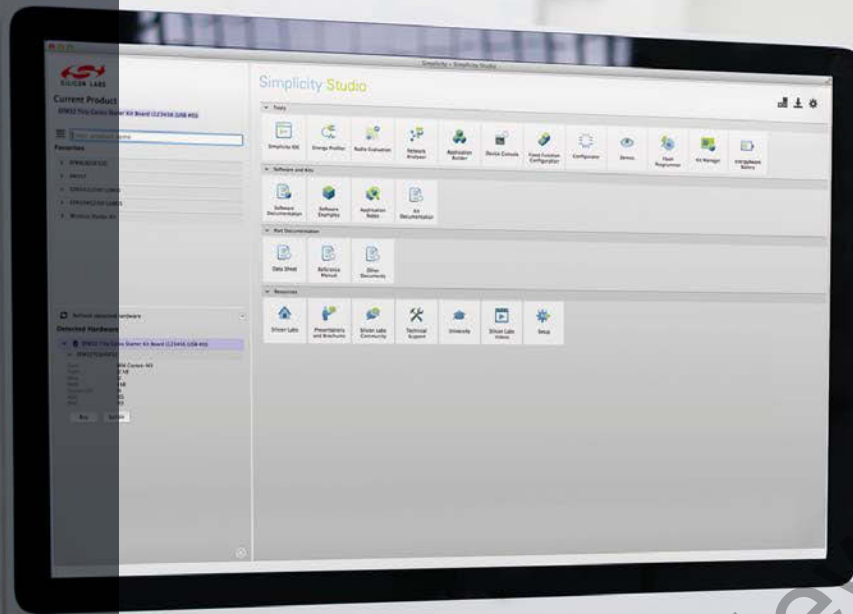

Figure 8.1. Measuring CPT007B SLEXP8007A Current Using AEM

9. Schematics, Assembly Drawings, and BOM

The schematics, assembly drawings and bill of materials (BOM) for the CPT007B Capacitive Sense Evaluation Board are available through Simplicity Studio when the kit documentation package has been installed. To access these documents, click the **[Kit Documentation]** tile after selecting the device in the left pane.

Not Recommended for New Designs



Simplicity Studio

One-click access to MCU and wireless tools, documentation, software, source code libraries & more. Available for Windows, Mac and Linux!



IoT Portfolio
www.silabs.com/loT



SW/HW
www.silabs.com/simplicity



Quality
www.silabs.com/quality



Support and Community
community.silabs.com

Disclaimer

Silicon Laboratories intends to provide customers with the latest, accurate, and in-depth documentation of all peripherals and modules available for system and software implementers using or intending to use the Silicon Laboratories products. Characterization data, available modules and peripherals, memory sizes and memory addresses refer to each specific device, and "Typical" parameters provided can and do vary in different applications. Application examples described herein are for illustrative purposes only. Silicon Laboratories reserves the right to make changes without further notice and limitation to product information, specifications, and descriptions herein, and does not give warranties as to the accuracy or completeness of the included information. Silicon Laboratories shall have no liability for the consequences of use of the information supplied herein. This document does not imply or express copyright licenses granted hereunder to design or fabricate any integrated circuits. The products must not be used within any Life Support System without the specific written consent of Silicon Laboratories. A "Life Support System" is any product or system intended to support or sustain life and/or health, which, if it fails, can be reasonably expected to result in significant personal injury or death. Silicon Laboratories products are generally not intended for military applications. Silicon Laboratories products shall under no circumstances be used in weapons of mass destruction including (but not limited to) nuclear, biological or chemical weapons, or missiles capable of delivering such weapons.

Trademark Information

Silicon Laboratories Inc., Silicon Laboratories, Silicon Labs, SiLabs and the Silicon Labs logo, CMEMS®, EFM, EFM32, EFR, Energy Micro, Energy Micro logo and combinations thereof, "the world's most energy friendly microcontrollers", Ember®, EZLink®, EZMac®, EZRadio®, EZRadioPRO®, DSPLL®, ISOModem®, Precision32®, ProSLIC®, SiPHY®, USBXpress® and others are trademarks or registered trademarks of Silicon Laboratories Inc. ARM, CORTEX, Cortex-M3 and THUMB are trademarks or registered trademarks of ARM Holdings. Keil is a registered trademark of ARM Limited. All other products or brand names mentioned herein are trademarks of their respective holders.



SILICON LABS

Silicon Laboratories Inc.
 400 West Cesar Chavez
 Austin, TX 78701
 USA

<http://www.silabs.com>