

SPECIFICATION

- Part No. : **MA650.ST.AB.003.dz**
- Product Name : Spartan ST Antenna 2in1 MA650
Low Profile Screw Mount (Permanent Mount)
3G/2G, GPS-GLONASS combination antenna
- Feature : **1 x 3G/2G Antenna** (824~960MHz,
1710~2170MHz)
0.3m NFC200 Coaxial Cable with SMA(M)
Connector
1 x GPS/GLONASS/GALILEO 1575.42/1602MHz
Antenna
0.3m RG174 Coaxial Cable with SMA(M) Connector
IP69K and IP67 Waterproof
High Efficiency / Peak Gain Outdoor Antenna
Advanced RF Design and Materials
Heavy Duty – Integrated Metal Base/ Ground-plane
Dims: 147.5mm: Height 35.6mm
Custom cables and connectors available
RoHS Compliant



1. Introduction

The Spartan MA650.ST antenna is an omnidirectional, heavy-duty, fully IP69K and IP67 waterproof external M2M antenna for use in telematics, transportation, and remote monitoring applications.

This unique antenna delivers powerful 3G/2G antenna technology and GPS/GLONASS/GALILEO for next generation high bandwidth telematics navigation systems.

We have packed 2 high efficiency and gain antennas in an extremely robust IP69K direct mount antenna package. The antenna has its own ground-plane and can radiate on any mounting environment like metal or plastic without affecting performance. The cables are low loss allowing for lengths of up to 5 meters (16 ' and 4.85 "), critical for buses, trains and other commercial transport applications.

For industries such as commercial vehicle telematics, remote monitoring, smart meter systems, construction equipment, at only 40mm high, the Spartan provides an unobtrusive, robust, rugged antenna that is durable even in extreme environments.

Customized cable length and connector versions are available upon request.

2. Specification Table

3G/2G Antenna						
Frequency (MHz)		824~894	880~960	1710~1880	1850~1990	1920~2170
Peak Gain (dBi)	30cm	0.65	0.16	4.05	4.05	3.64
	1m	2.64	1.97	3.46	3.97	3.46
	2m	1.60	1.24	3.32	3.26	2.73
	3m	2.17	1.34	2.87	3.01	2.56
	5m	-0.82	-1.34	1.57	2.22	1.72
Average Gain (dBi)	30cm	-4.76	-5.43	-3.48	-2.45	-4.10
	1m	-4.26	-5.78	-3.79	-2.86	-4.23
	2m	-4.46	-6.35	-4.12	-3.38	-5.32
	3m	-4.80	-5.97	-4.91	-3.61	-5.08
	5m	-5.61	-6.56	-6.35	-4.34	-5.81
Efficiency (%)	30cm	33.89	29.95	47.05	57.47	40.88
	1m	38.06	27.70	43.75	52.18	38.82
	2m	36.11	24.40	40.27	46.10	31.16
	3m	33.56	23.25	34.56	43.83	32.12
	5m	27.96	23.10	25.00	36.89	27.06
Return loss (dB)	< -5					
Polarization	Linear					
Impedance	50Ω					
Cable	0.3m CFD200 standard, fully customizable					
Connector	SMA(M), standard, fully customizable					
Maximum Input Power	5W					

GPS-GLONASS-GALILEO	
Center Frequency	GPS/GALILEO:1575.42±3 MHz GLONASS:1602±0.5 MHz
Gain	3 ±1 dBic typ.
VSWR	1.5:1 Max
Impedance	50Ω
Cable	0.3m RG174 standard, fully customizable
Connector	SMA(M), standard, fully customizable

LNA Electrical Properties	
Center Frequency	GPS/GALILEO:1575.42±3 MHz GLONASS:1602±0.5 MHz
Impedance	50 Ohm
VSWR	< 1.5:1
Return Loss	10 dB Min.
Gain	32 dB Min. @ 5.0V 28 dB Min. @ 3.3V 21 dB Min. @ 1.8V
DC Power Input	1.8~5.0V
Noise Figure @3.3V	1.6dB
Power Consumption	10mA @ 3.3V

MECHANICAL	
Antenna Dimensions	147.5*145.6*35.6mm
Casing	Wonderloy PC-540 PC/ABS Alloy
Waterproof	IP69K and IP67
Thread	M20*1.5P
Weight	570g
Recommended Assembly Torque	29.4 N·m
Maximum Assembly Torque	39.2 N·m
ENVIRONMENTAL	
Operation Temperature	-40°C to 85°C
Storage Temperature	-40°C to 90°C
Humidity	Non-condensing 65°C 95% RH

3. Cellular Antenna Characteristics

3.1. Return Loss

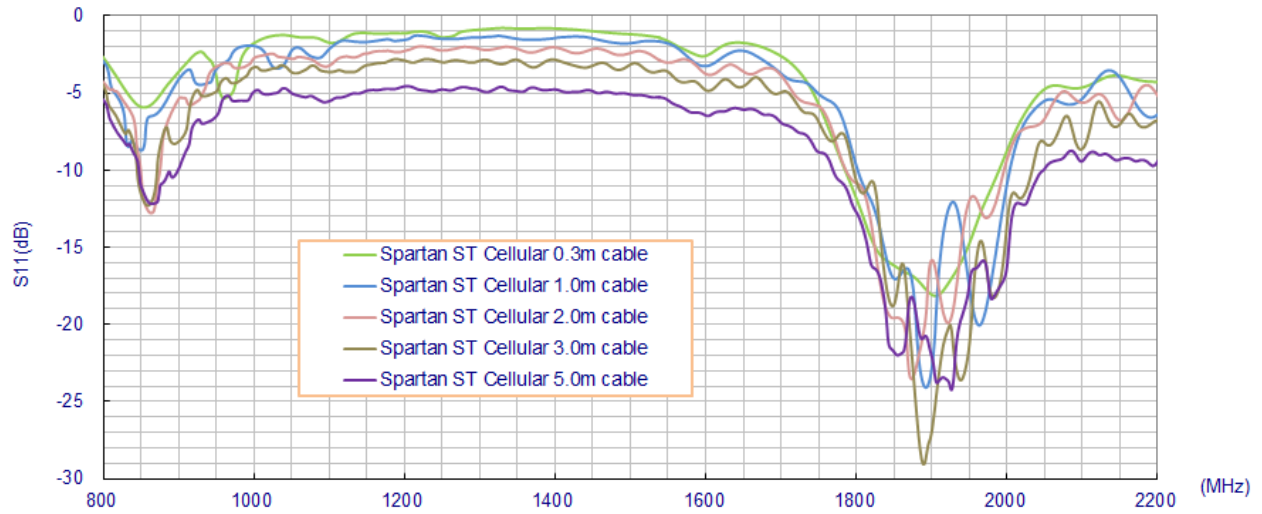

3.2. Peak Gain

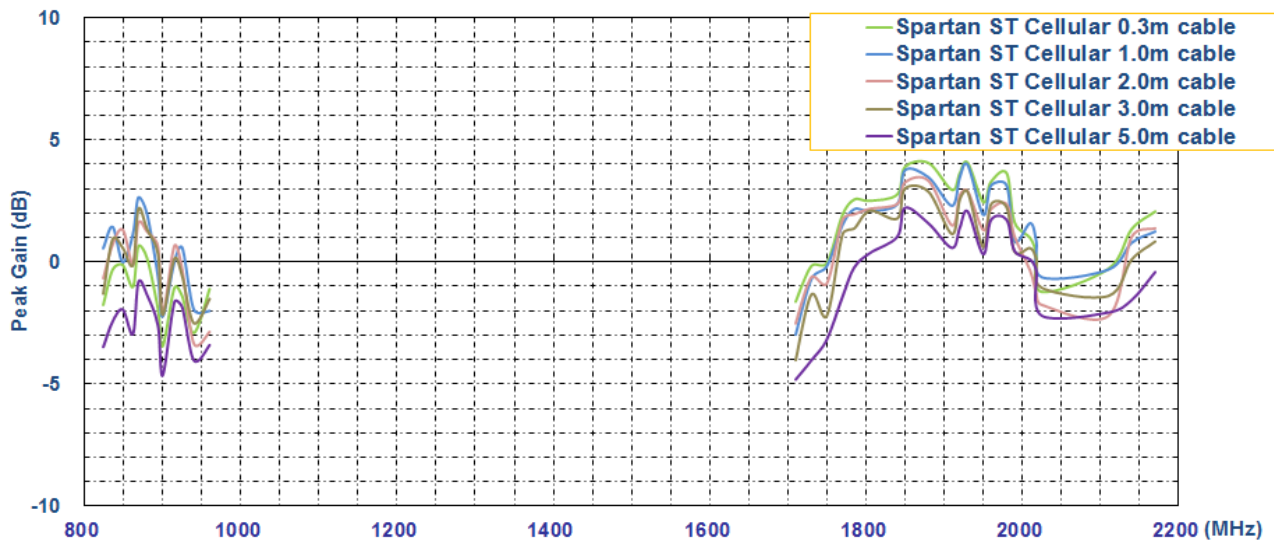

3.3. Average Gain

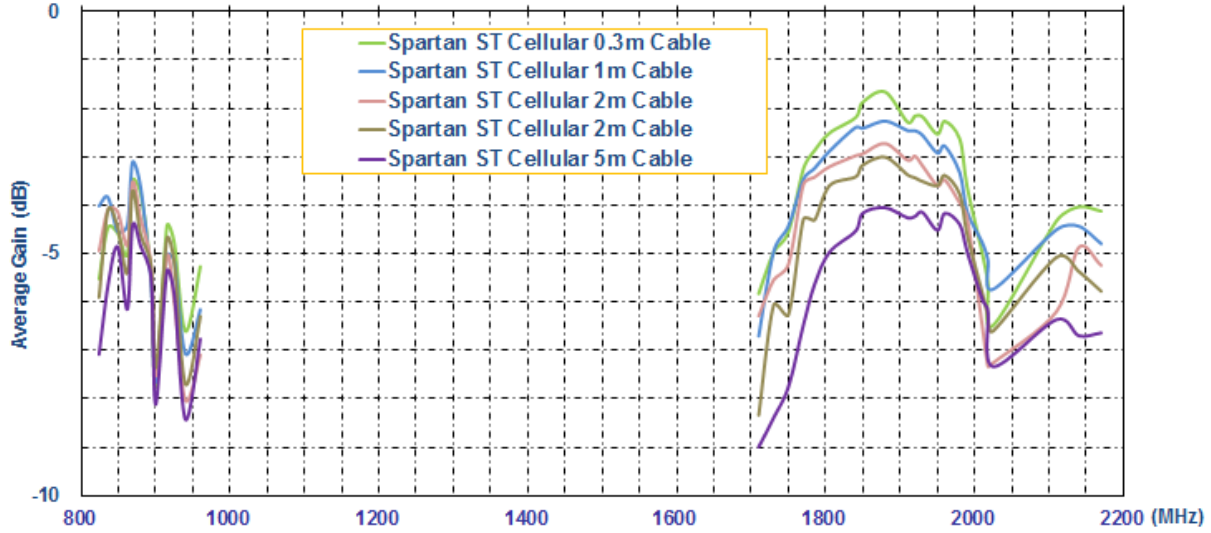

3.4. Efficiency

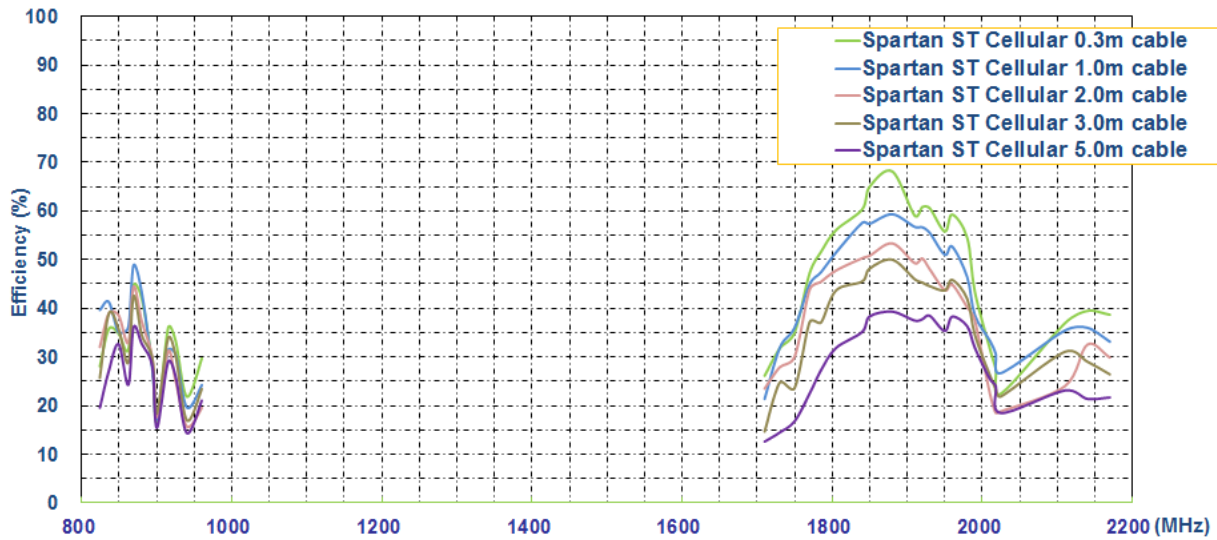

3.5. Radiation Patterns

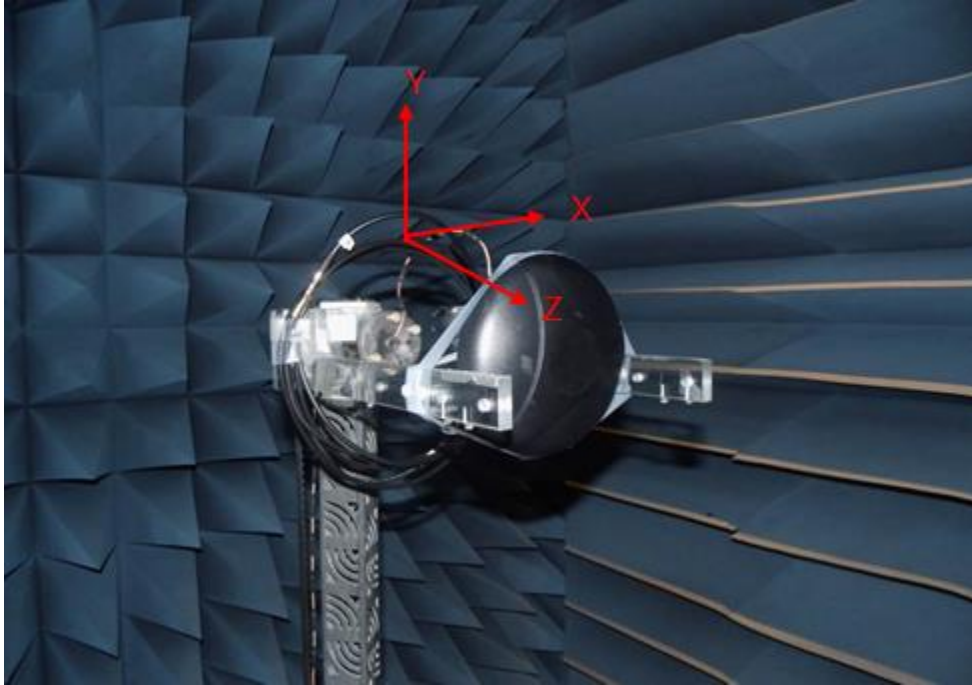

3.5.1. 2D Radiation Patterns

XY Plane

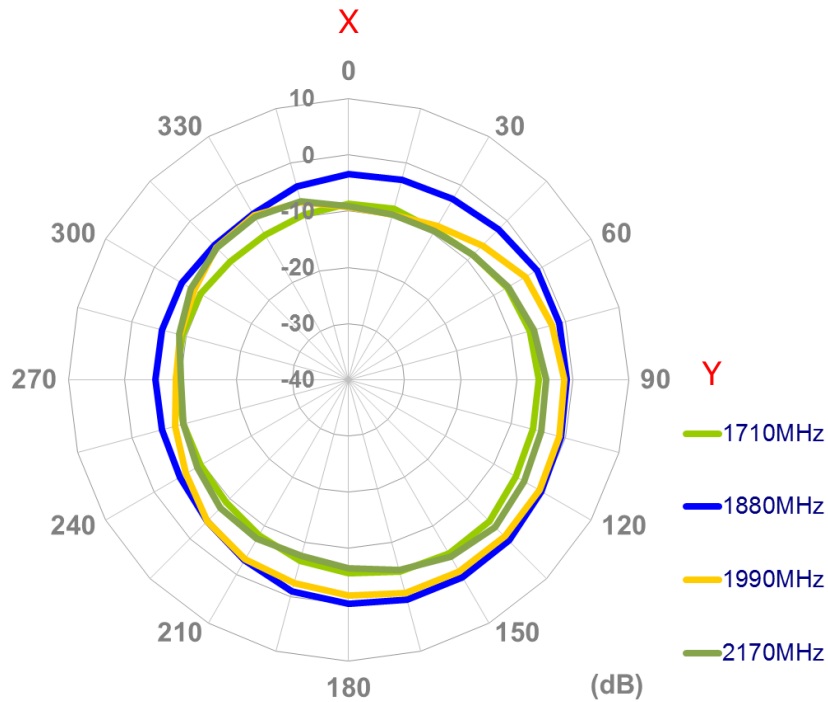
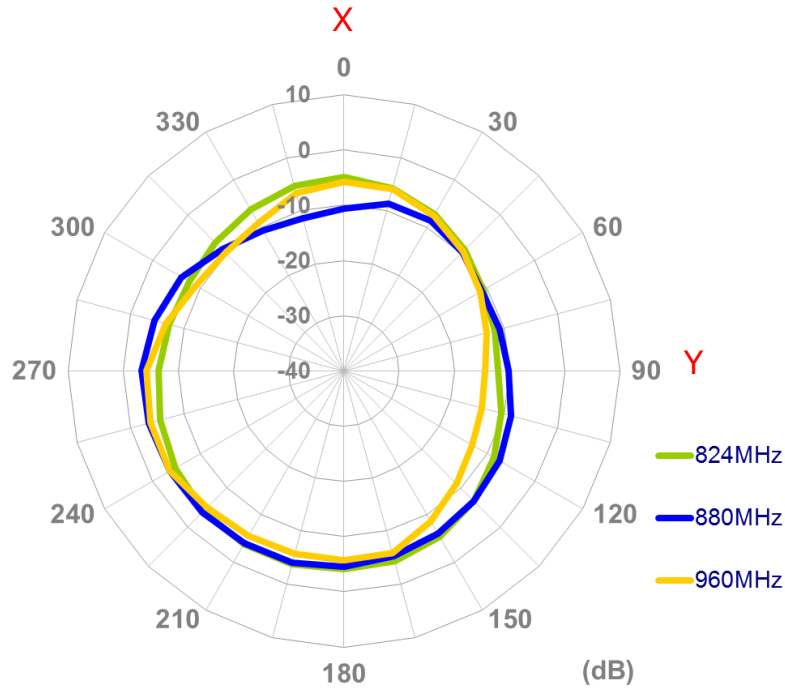

XZ Plane

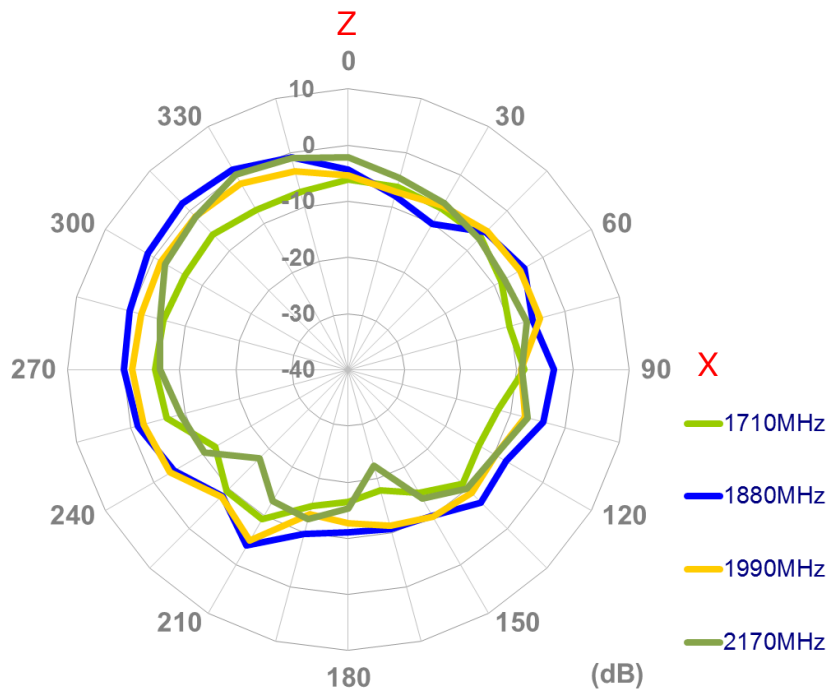
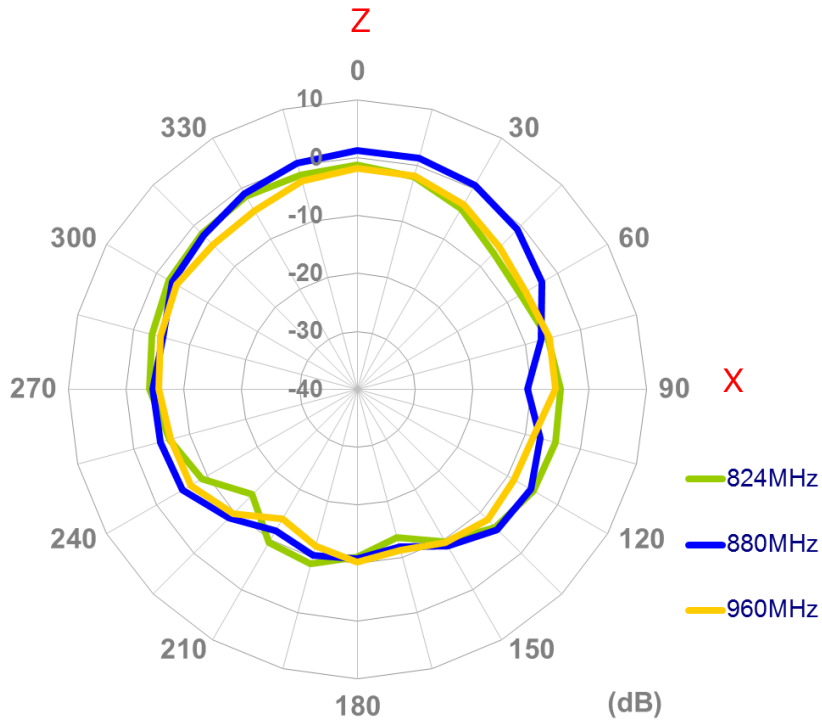

3.5.2. 3D Radiation Patterns

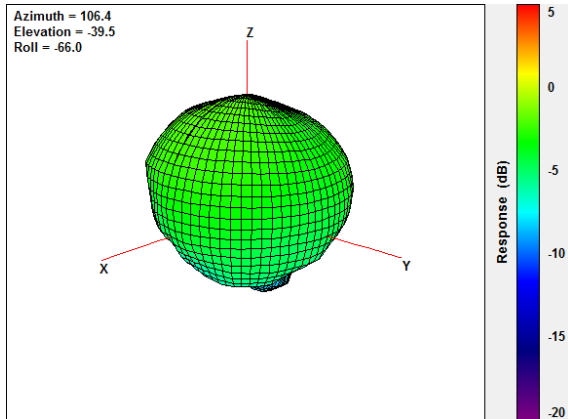

@824MHz

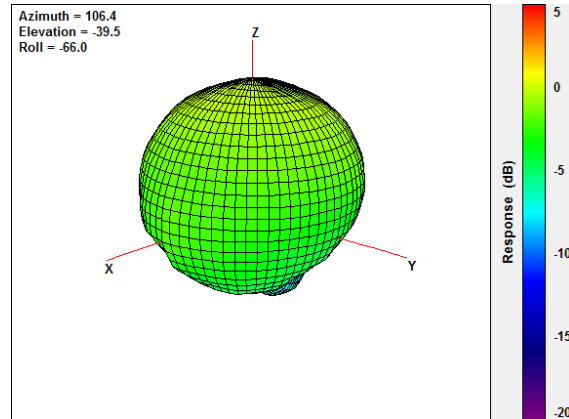

@880MHz

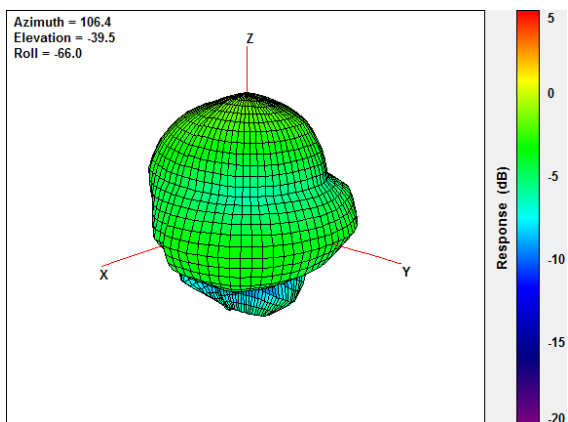

@960MHz

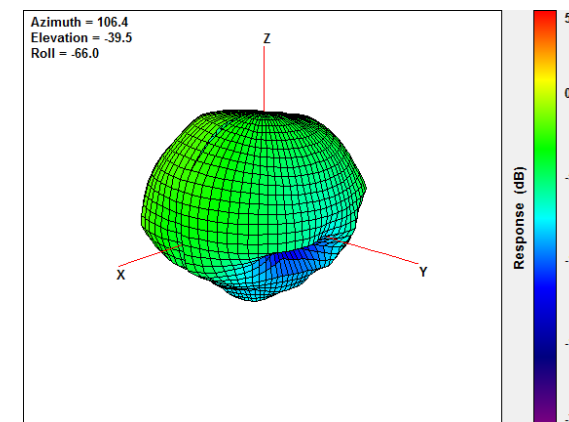

@1710MHz

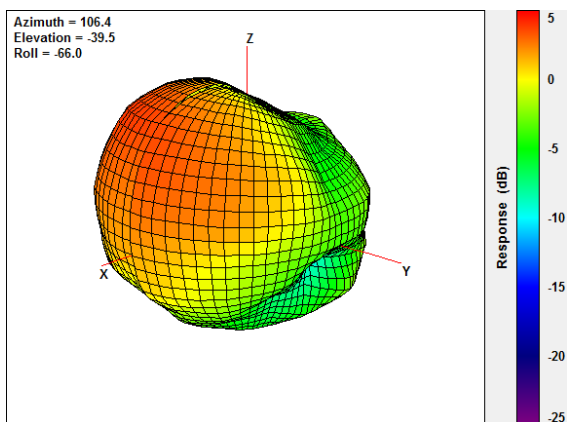

@1880MHz

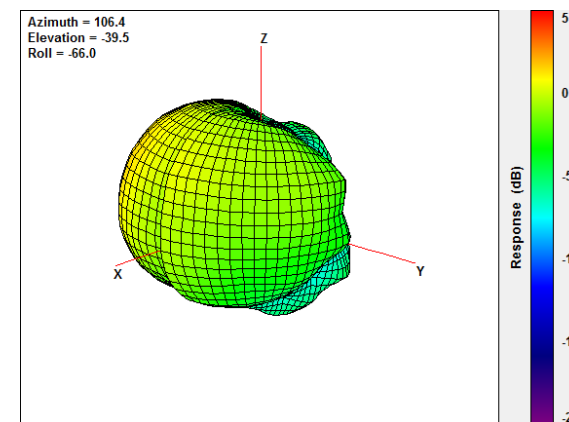

@1990MHz

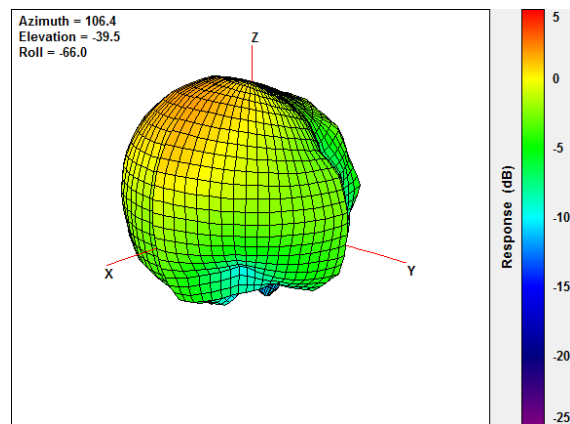

@2170MHz

4. GPS-GLONASS-GALILEO Antenna Characteristics

4.1. Block diagram

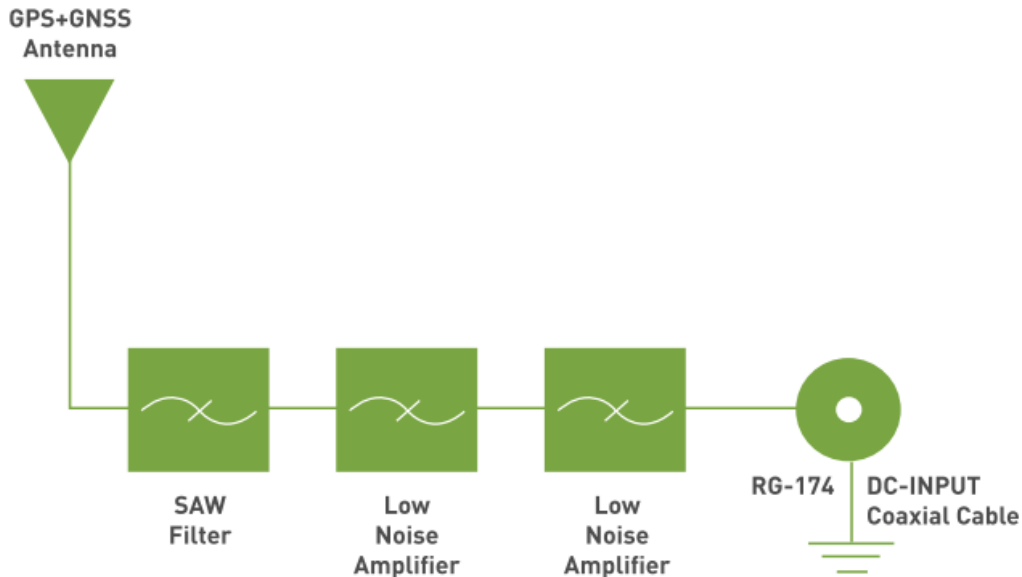

4.2. Return Loss

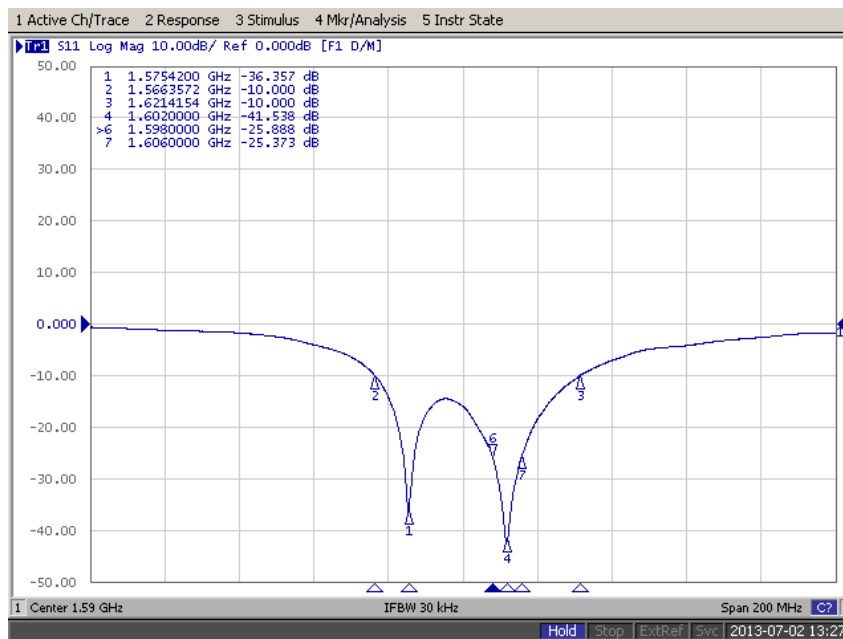

4.3. Smith Chart

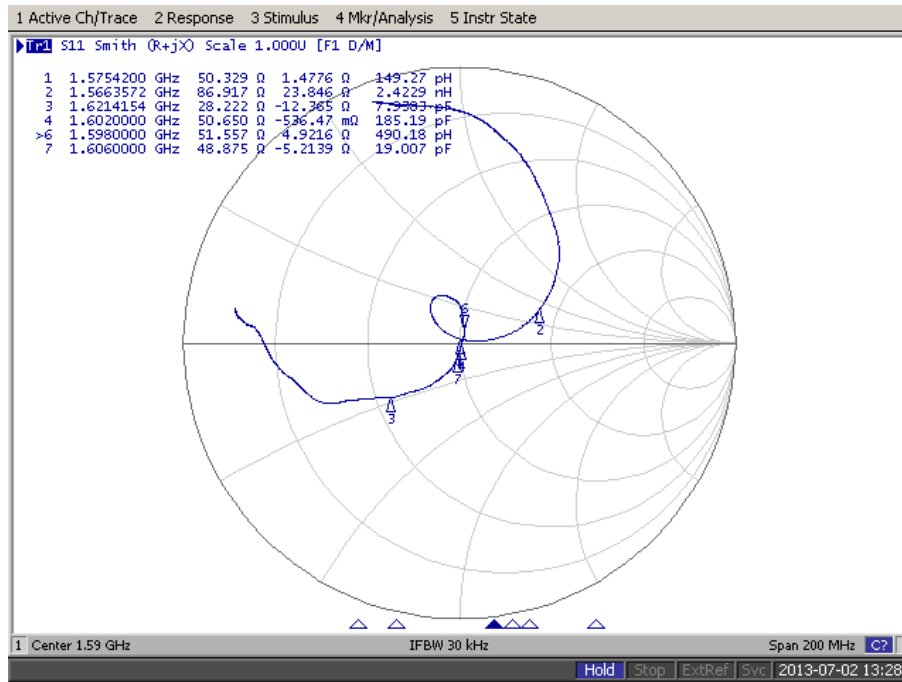

4.4. 3D Efficiency Table (passive antenna)

Frequency (MHz)	Return Loss(dB)	Impedance(Ω)	Gain 0° H-Plane(dBic)	Gain 0° E-Plane(dBic)
1575.42	-36.3	50.3 + j 1.4	3.34	3.77
1598	-25.8	51.5 + j 4.9	3.49	3.63
1602	-41.5	50.6 - j 0.5	3.23	3.35
1606	-25.3	48.8 - j 5.2	2.93	3.05

4.5. LNA S-parameter

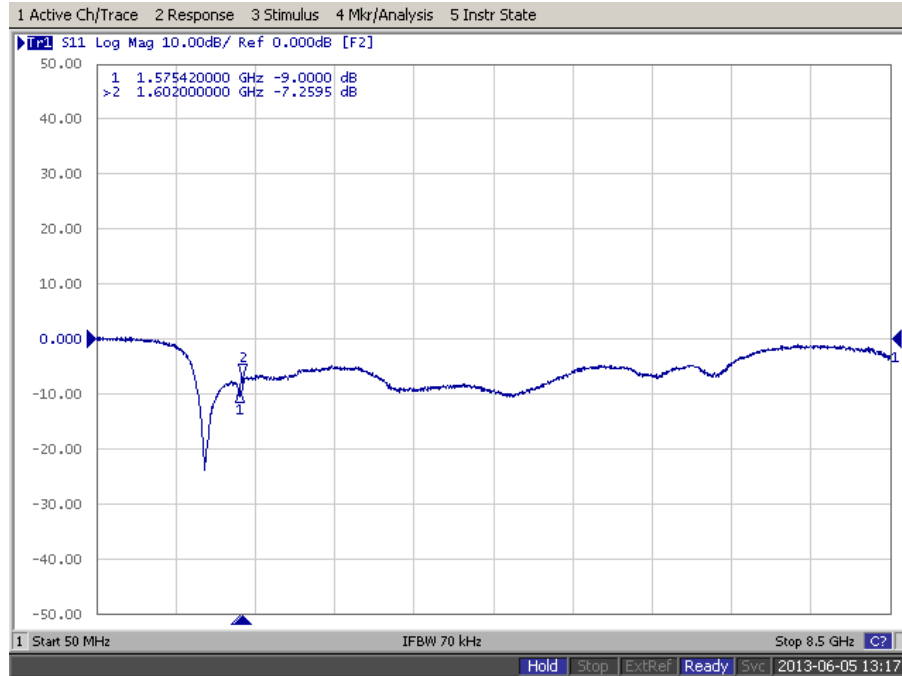

4.6. LNA Noise Figure

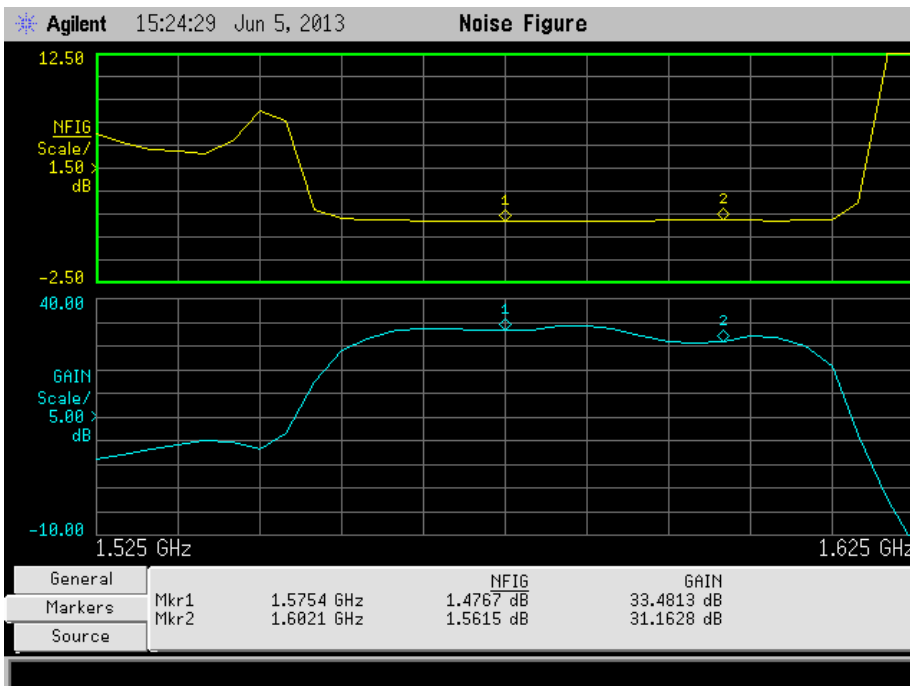

4.7. Radiation Pattern

2D-radiation pattern Free Space @1575.42MHz

Far-field amplitude of ST256-H.nsi

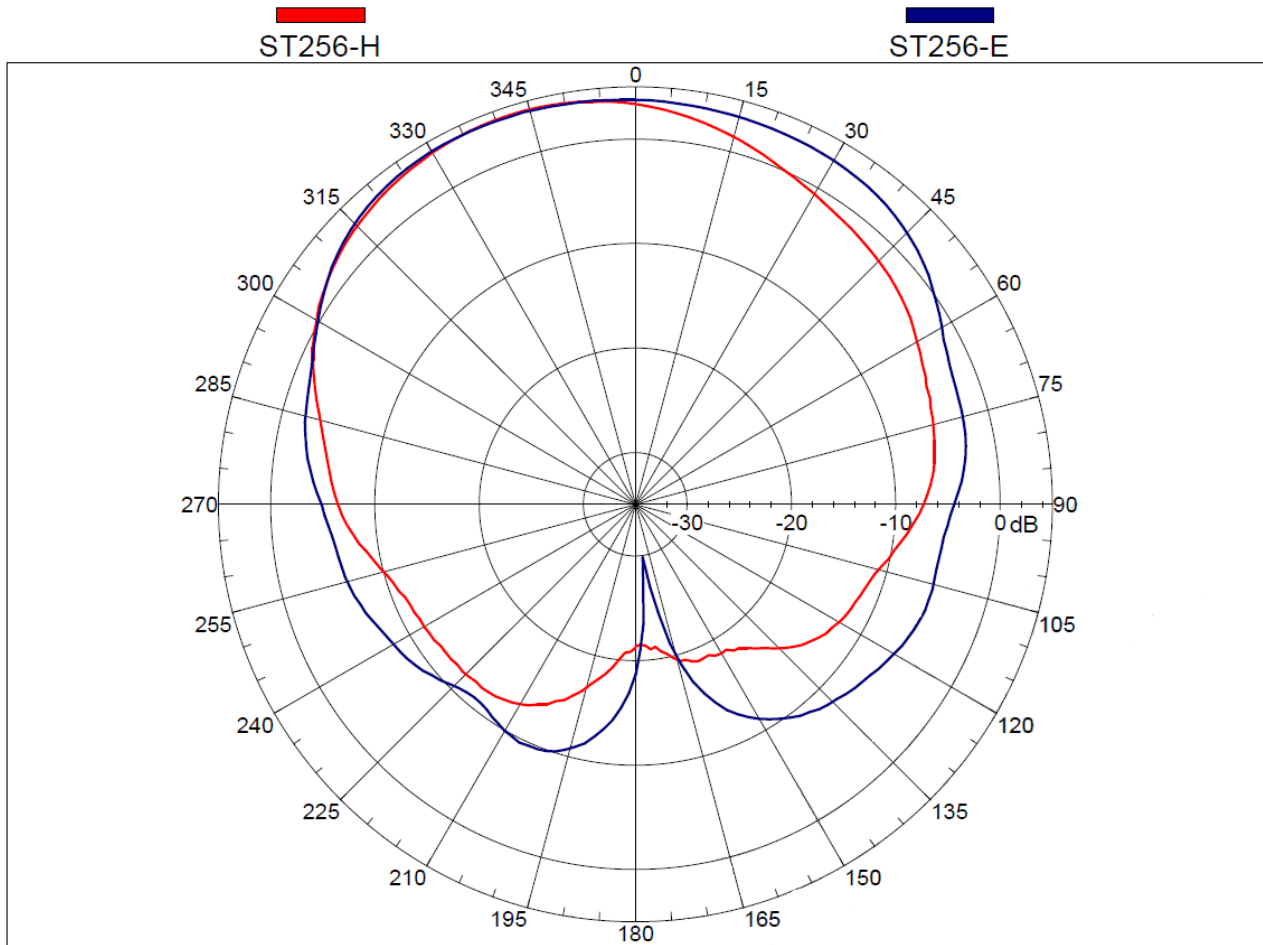

Red Line : H-plane; Blue Line : E-plane

2D-radiation pattern Free Space @1602MHz

Far-field amplitude of ST256-H.nsi

 ST256-H

 ST256-E

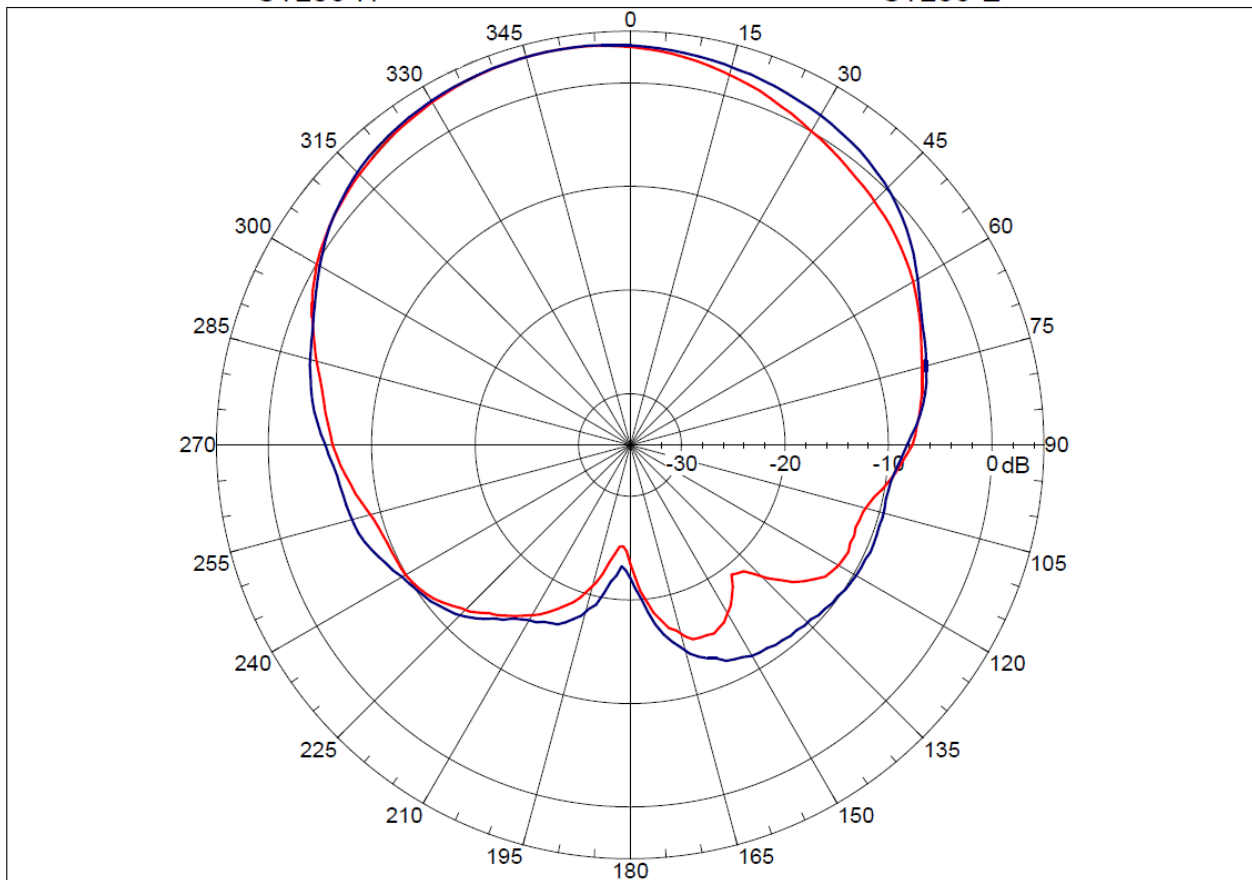

Red Line : H-plane ; Blue Line : E-plane

5. Drawing

Top View

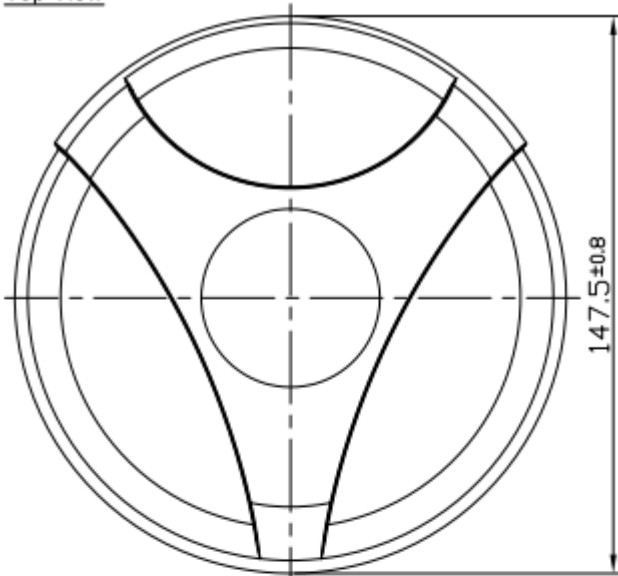

Side View

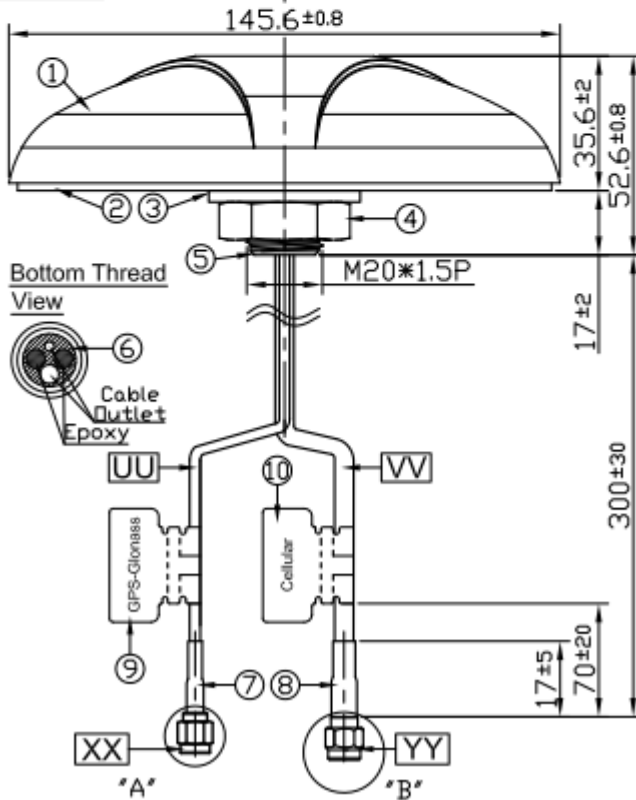

SMA(M) ST For RG174

DETAIL 1'A'
SCALE: 2/1

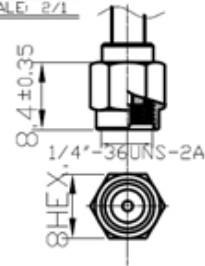

SMA(M) ST For NFC200

DETAIL 1'B'
SCALE: 2/1

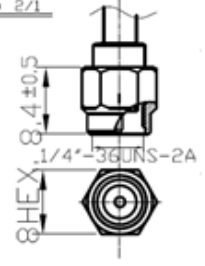

	Name	Material	Finish	QTY
1	Housing Spartan ST	PC+ABS	Black	1
2	Closed Cell Foam	3M 9448+CR-4305	Black	1
3	Nut_M20x1.5Px10H Cut	Steel	Ni Plated	1
4	Washer_Cut	Steel	Ni Plated	1
5	Metal Base ST	Zinc Alloy	Ni Plated	1
6	Cable Rubber ST_4IN1	Silicone Rubber	Black	1
7	Heat Shrink Tube (RG-174)	PE	Black	1
8	Heat Shrink Tube	PE	Black	1
9	GPS-Glonass Label	Coated Paper	Orange	1
10	Cellular Label	Coated Paper	Blue	1

	Name	Spec	Finish	QTY
UU	Cable Type	RG-174	Black	1
VV	Cable Type	NFC-200	Black	1
XX	Connector Type	SMA(M) ST	Gold	1
YY	Connector Type	SMA(M) ST	Gold	1

6. Installation

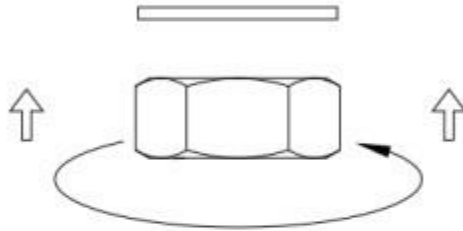
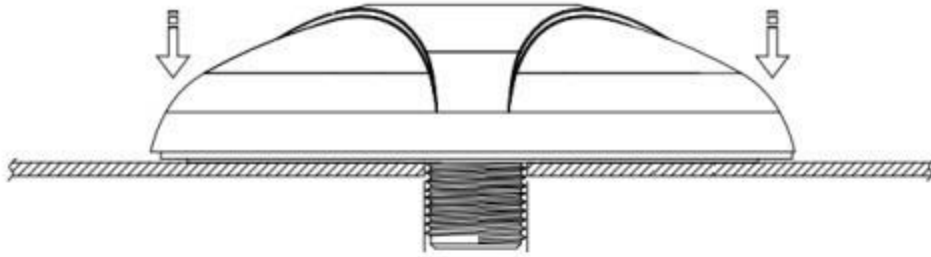

Recommended Torque for Mounting 29.4 N·m
 Maximum Torque for Mounting 39.2N·m

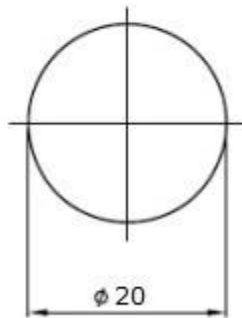

**Thread
 Diameter**

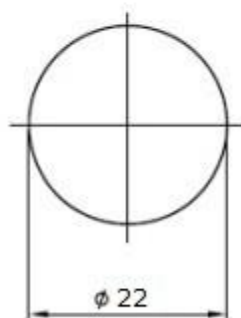

**Recommended
 Mounting Hole**

Unit: mm

7. Packaging

1pc MA650.ST.AB.003.dz per small box
 Box Dimensions - 180*165*130mm
 Weight - 830g

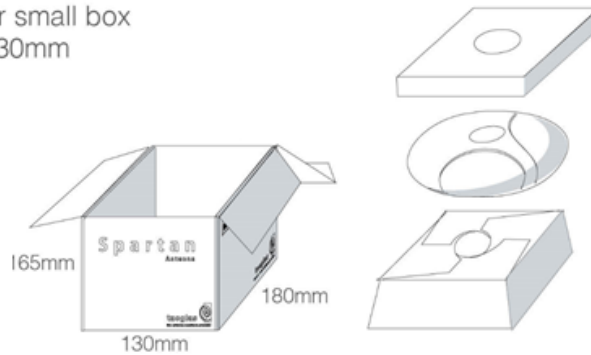

10 small boxes in one carton
 Carton Dimensions - 700*360*220mm
 Weight - 9.4Kg

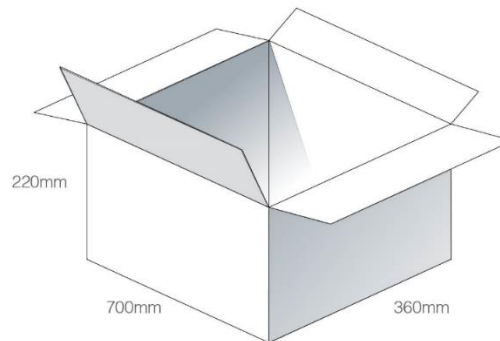

Pallet Dimensions 1100*1100*1450mm
 24 Cartons per Pallet
 4 Cartons per layer
 6 Layers

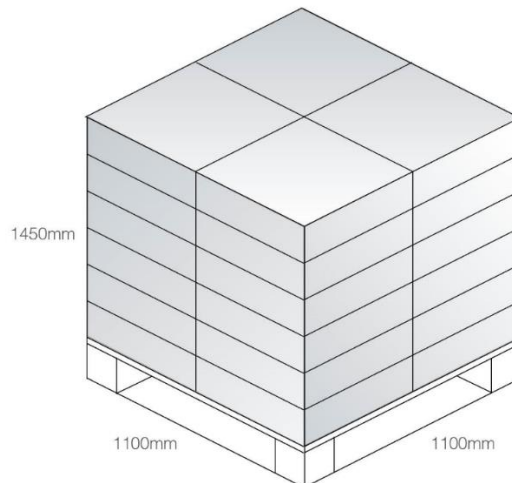

Taoglas makes no warranties based on the accuracy or completeness of the contents of this document and reserves the right to make changes to specifications and product descriptions at any time without notice. Taoglas reserves all rights to this document and the information contained herein.

Reproduction, use or disclosure to third parties without express permission is strictly prohibited.

Copyright © Taoglas Ltd.