

SPECIFICATION

Part No.	:	AA.105.301621
Product Name	:	Titan GPS/GALILEO Antenna AA.105 3M RG174 Fakra Code C Blue SMB(F)
Features	:	Magnetic Mount Covert stylish design Wide band input voltage 28db Gain Gain is Customizable IP-67 Waterproof

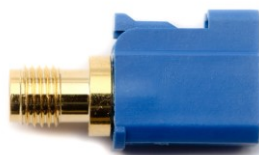

1. Introduction

Our AA.105 Titan magnetic mount external antenna is ideal for robust, covert installations where durability and small size is paramount. It is used in telematics and M2M applications, for example in commercial vehicle installations for fleet management. It is fully waterproof to IP67 rating.

2. Specifications

GPS/GALILEO Antenna	
Outline Dimension	25*25*4mm
Ground Size	25*25*4mm
Center Frequency	1575.42±3MHz
Bandwidth	10MHz
VSWR	1.92 Max
Axial ratio	3dB Typ.
Gain @ Zenith	2dBi Typ.
Impedance	50Ω
Polarization	RHCP

LNA	
Frequency	1575.42MHz
Impedance	50Ω
VSWR	1.92 Max.
Gain	30dB Typ.
Gain at Connector*	28.4dB
DC Power Input	2.7~5V
Noise Figure	1.5dB Typ.
Weight	75g
Power Consumption	4.7mA @2.7V 6mA @3.3V 10.3mA @5V
Operating temp	-40°C ~ +85°C
Storage Temp	-40°C ~ +90°C

3. Ceramic Antenna S11 (with housing)

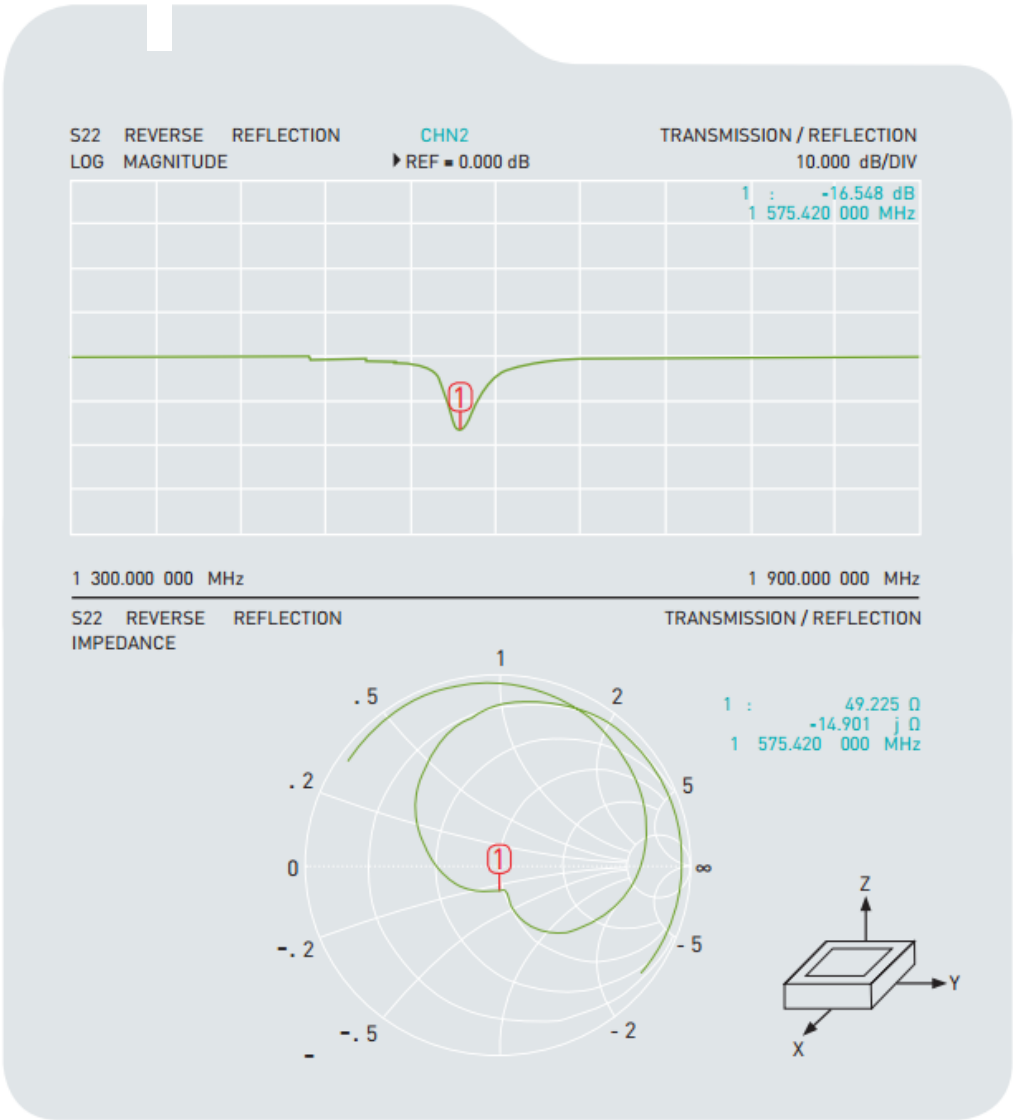

4. Ceramic Antenna Radiation Pattern (with housing)

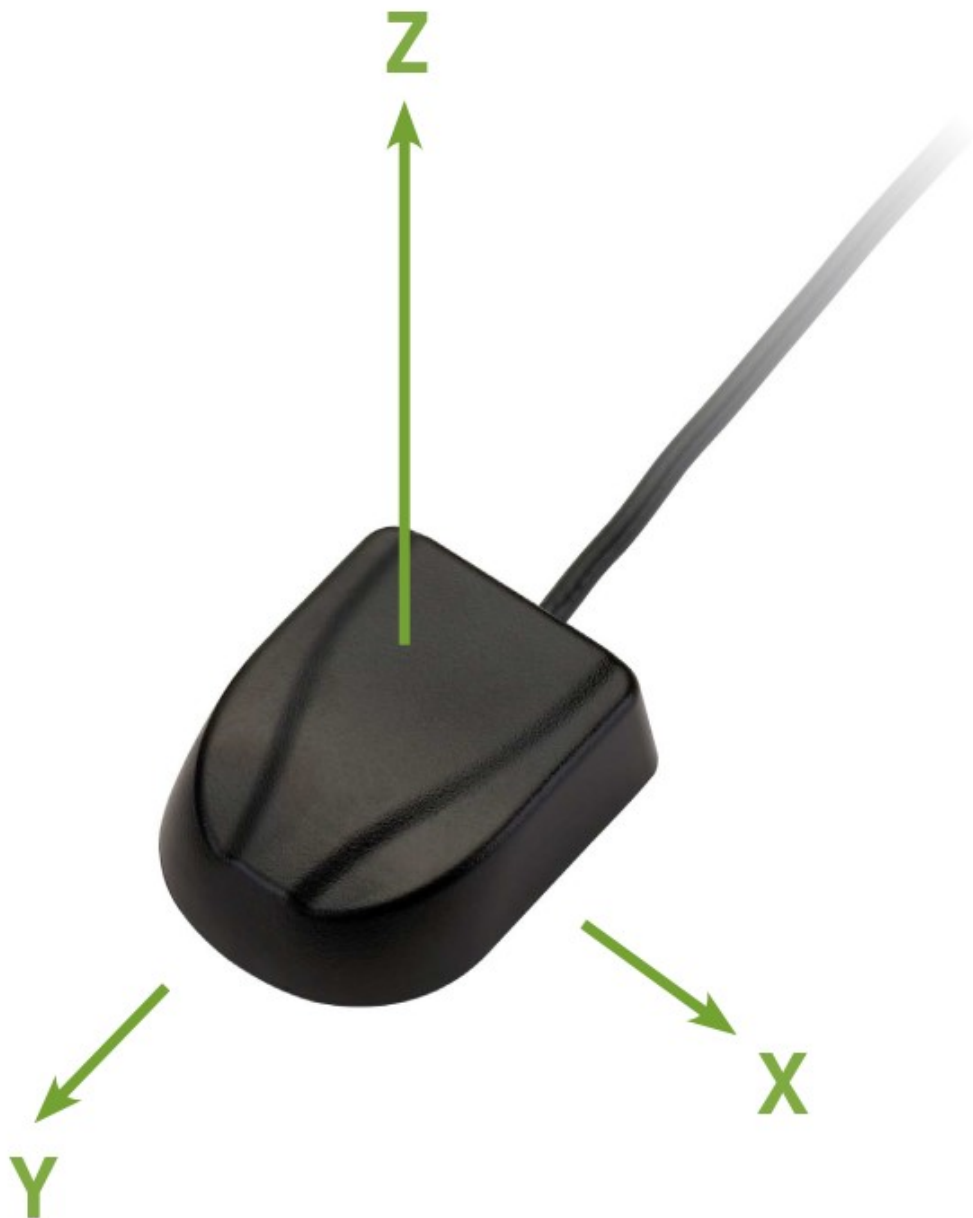

XZ Plane

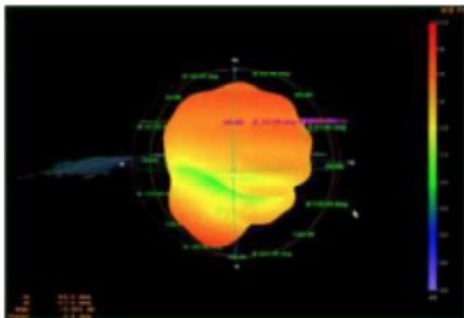

YZ Plane

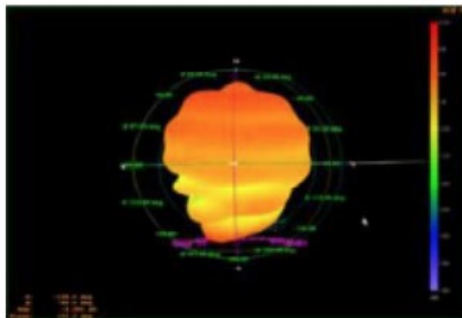

Far-field amplitude of goasial
1583 06-5-8.nsi

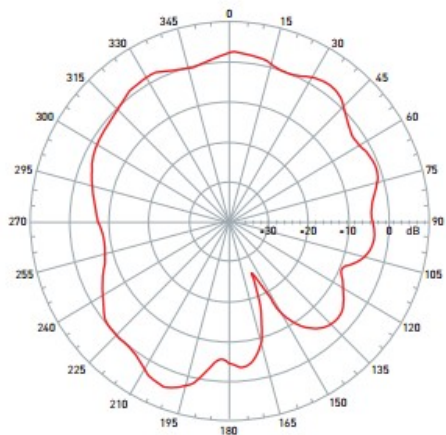

Far-field amplitude of goasial
1583 06-5-8.nsi

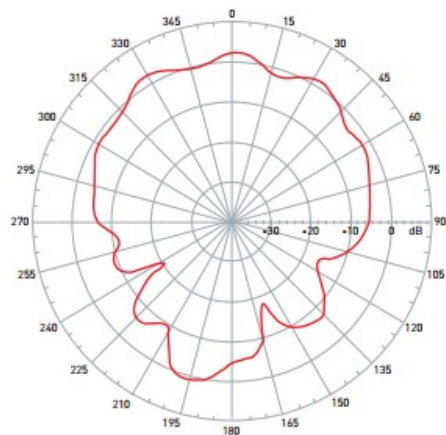

5. LNA gain

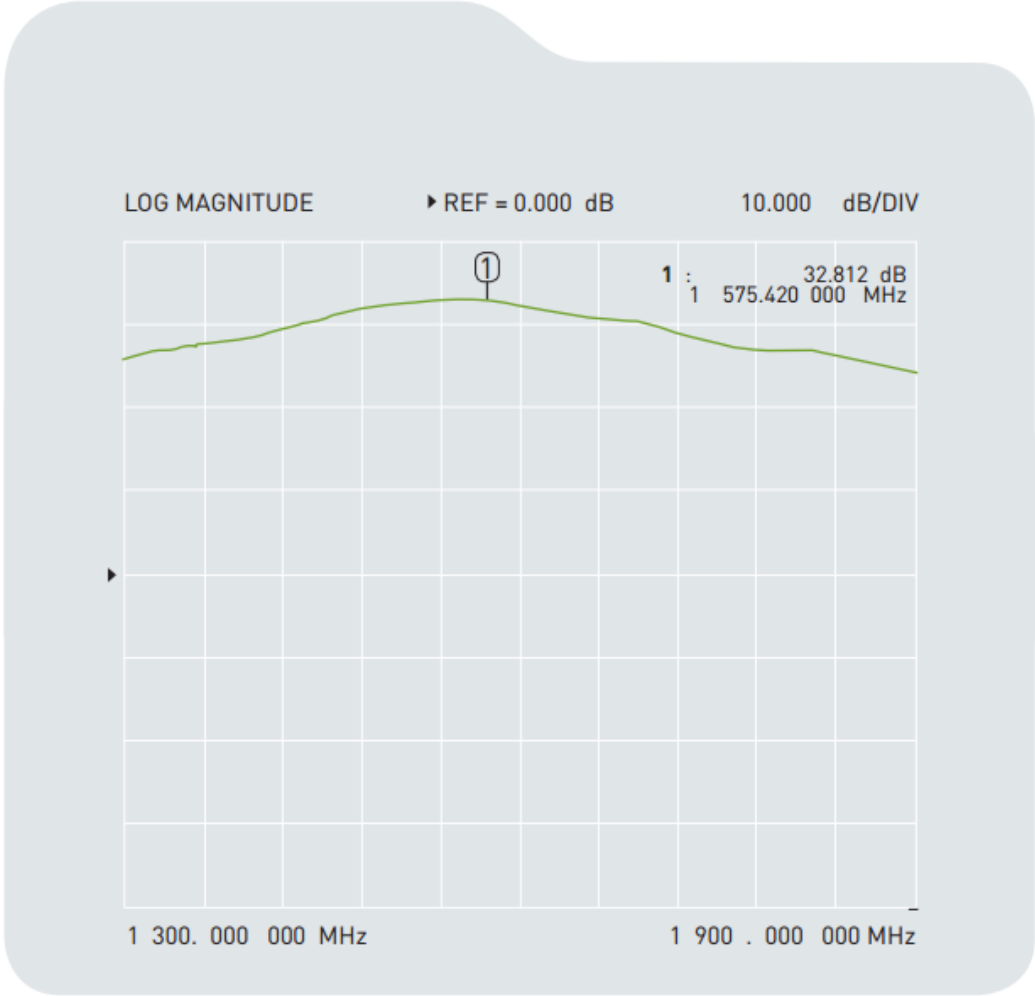

6. LNA S22

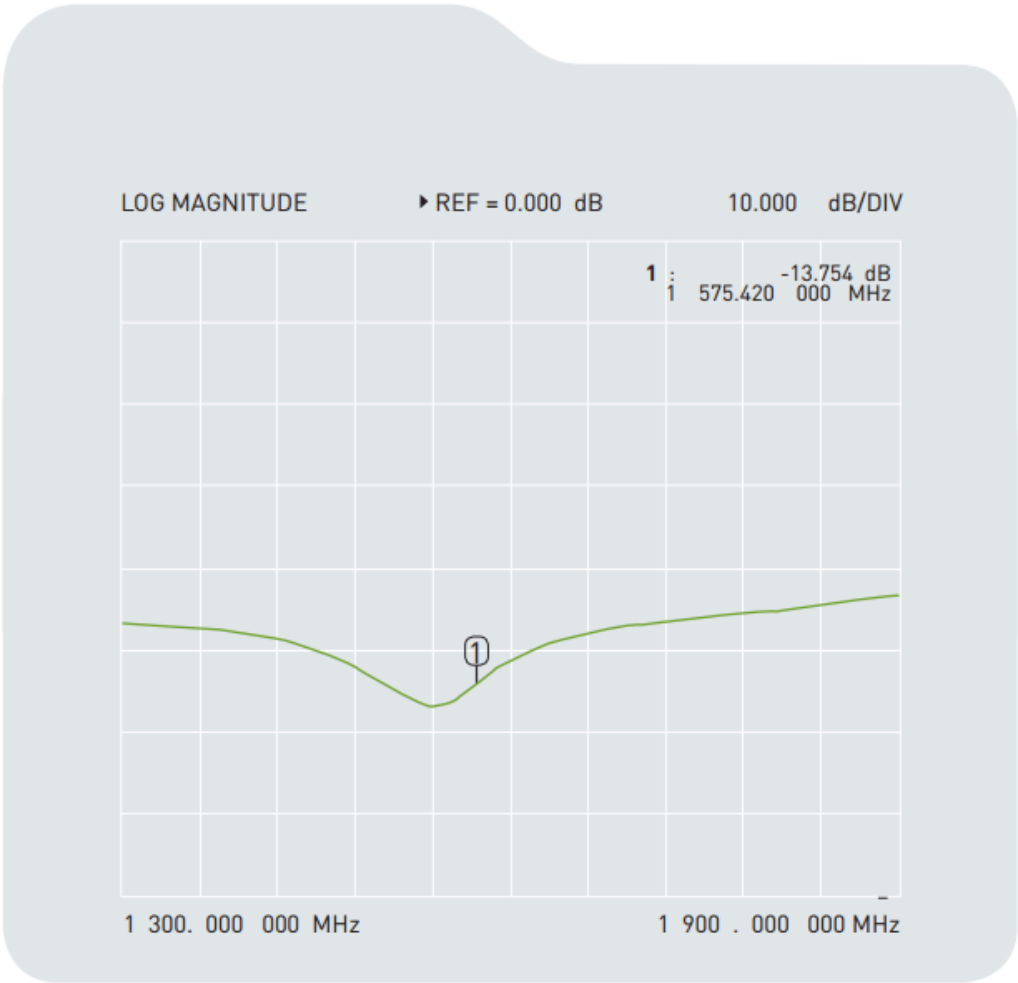

Packaging (Unit: mm)

1 AA.105.301621 per PE bag
 Bag Dimensions - 220*105mm
 Total Weight - 72g



10pcs / PE bags per large PE Bag
 Large Bag Dimensions - 260*460mm
 Weight - 9.1Kg

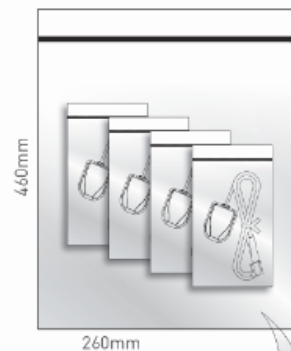

12 Large PE Bags per Outer Carton
 Carton Dimensions - 400*400*220mm
 Weight - 9.6Kg

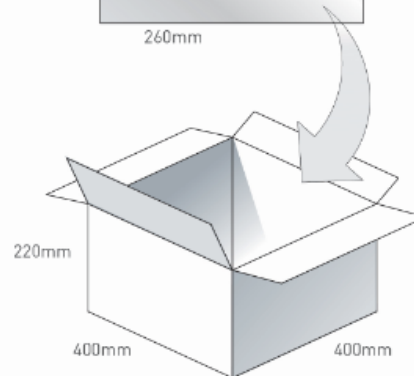

Pallet Dimensions 1100*1100*1500mm
 48 Cartons per pallet
 12 Cartons per layer
 4 Layers

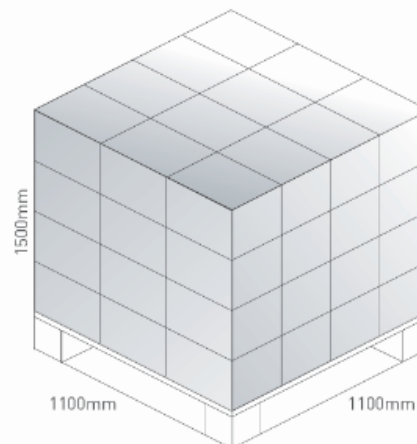

Taoglas makes no warranties based on the accuracy or completeness of the contents of this document and reserves the right to make changes to specifications and product descriptions at any time without notice. Taoglas reserves all rights to this document and the information contained herein.

Reproduction, use or disclosure to third parties without express permission is strictly prohibited.

Copyright © Taoglas Ltd.