

## FLARE-MAXI-TAPE

34 x 33 mm lens with ~100° x 15° oval beam.  
Assembly with installation tape.

### TECHNICAL SPECIFICATIONS:

Dimensions	33.9 x 33.3 mm
Height	16.9 mm
Fastening	tape, pin
ROHS compliant	yes ⓘ



### MATERIAL SPECIFICATIONS:

Component	Type	Material	Colour	Finish
FLARE-MAXI	Single lens	PMMA	clear	
FLARE-MAXI-TAPE	Tape	Acrylic foam	clear	

### ORDERING INFORMATION:

Component		Qty in box	MOQ	MPQ	Box weight (kg)
CA14366_FLARE-MAXI-TAPE	Single lens	864	144	72	9.7
» Box size:					

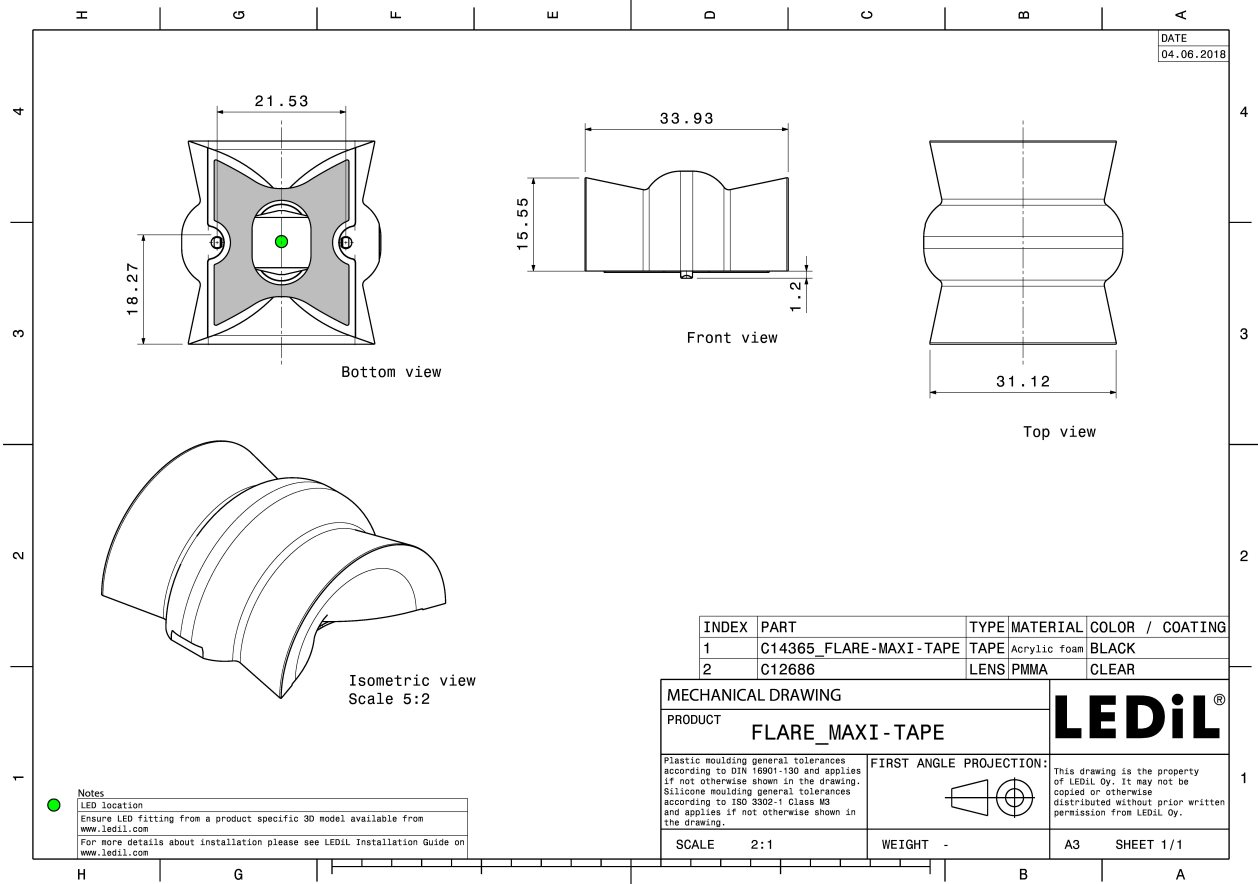

See also our general installation guide: [www.ledil.com/installation\\_guide](http://www.ledil.com/installation_guide)

#### PHOTOMETRIC DATA (MEASURED):

##### CREE LED

LED XM-L  
FWHM / FWTM 96.0 + 15.0° / 175.0°  
Efficiency 94 %  
Peak intensity 2.1 cd/lm  
LEDs/each optic 1  
Light colour White  
Required components:

##### CREE LED

LED XM-L2  
FWHM / FWTM 105.0 + 13.0°  
Efficiency 96 %  
LEDs/each optic 1  
Light colour White  
Required components:

##### CREE LED

LED XP-G  
FWHM / FWTM 105.0 + 11.0° / 174.0°  
Efficiency 94 %  
Peak intensity 2.5 cd/lm  
LEDs/each optic 1  
Light colour White  
Required components:

##### CREE LED

LED XP-G2  
FWHM / FWTM 96.0 + 10.0° / 162.0°  
Efficiency 94 %  
Peak intensity 3.1 cd/lm  
LEDs/each optic 1  
Light colour White  
Required components:

#### PHOTOMETRIC DATA (MEASURED):

##### CREE LED

LED XP-L HD  
 FWHM / FWTM 115.0 + 13.0° / 149.0 + 19.0°  
 Efficiency 94 %  
 Peak intensity 2.1 cd/lm  
 LEDs/each optic 1  
 Light colour White  
 Required components:

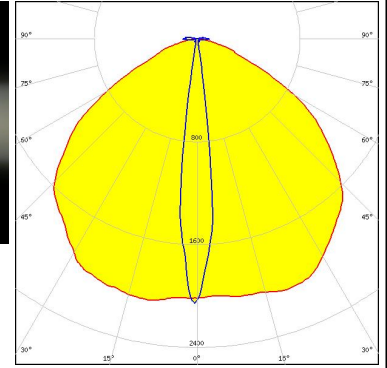
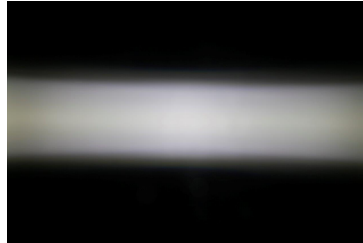

##### CREE LED

LED XP-L2  
 FWHM / FWTM 99.0 + 13.0° / 158.0 + 21.0°  
 Efficiency 94 %  
 Peak intensity 2 cd/lm  
 LEDs/each optic 1  
 Light colour White  
 Required components:

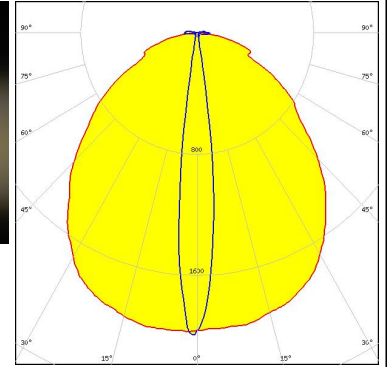

##### CREE LED

LED XT-E  
 FWHM / FWTM 96.0 + 10.0° / 183.0°  
 Efficiency 94 %  
 Peak intensity 2.5 cd/lm  
 LEDs/each optic 1  
 Light colour White  
 Required components:

##### LUMILEDS

LED LUXEON Rebel ES  
 FWHM / FWTM 91.0 + 10.0° / 164.0°  
 Efficiency 94 %  
 Peak intensity 2.8 cd/lm  
 LEDs/each optic 1  
 Light colour White  
 Required components:

### PHOTOMETRIC DATA (MEASURED):

#### LUMILEDS

LED LUXEON T  
FWHM / FWTM 96.0 + 10.0° / 262.0°  
Efficiency 92 %  
Peak intensity 2.9 cd/lm  
LEDs/each optic 1  
Light colour White  
Required components:

#### LUMILEDS

LED LUXEON TX  
FWHM / FWTM 96.0 + 9.0° / 141.0°  
Efficiency 94 %  
Peak intensity 3.2 cd/lm  
LEDs/each optic 1  
Light colour White  
Required components:

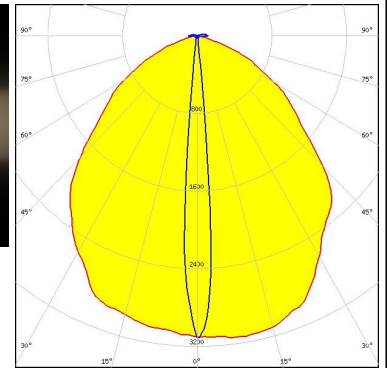

#### NICHIA

LED NCSxx19B  
FWHM / FWTM 98.0 + 9.0° / 170.0°  
Efficiency 94 %  
Peak intensity 3.5 cd/lm  
LEDs/each optic 1  
Light colour White  
Required components:

#### NICHIA

LED NVSxx19B/NVSxx19C  
FWHM / FWTM 98.0 + 11.0° / 176.0°  
Efficiency 94 %  
Peak intensity 2.4 cd/lm  
LEDs/each optic 1  
Light colour White  
Required components:

#### PHOTOMETRIC DATA (MEASURED):

#### OSRAM

Opto Semiconductors

LED OSLON Square PC  
 FWHM / FWTM 98.0 + 13.0° / 178.0°  
 Efficiency 94 %  
 Peak intensity 2.5 cd/lm  
 LEDs/each optic 1  
 Light colour White  
 Required components:

#### SAMSUNG

LED LH351Z  
 FWHM / FWTM 94.0 + 8.8° / 125.0 + 13.0°  
 Efficiency 94 %  
 Peak intensity 3.6 cd/lm  
 LEDs/each optic 1  
 Light colour White  
 Required components:

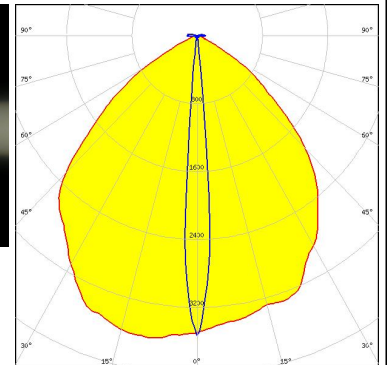
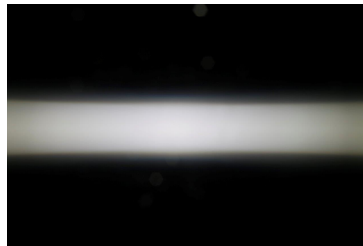

#### SEOUL SEMICONDUCTOR

LED Z5M3  
 FWHM / FWTM 97.0 + 10.0° / 154.0 + 17.0°  
 Efficiency 94 %  
 Peak intensity 2.6 cd/lm  
 LEDs/each optic 1  
 Light colour White  
 Required components:

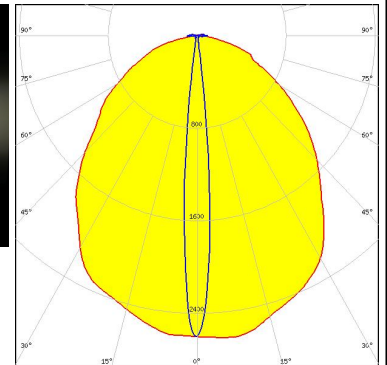
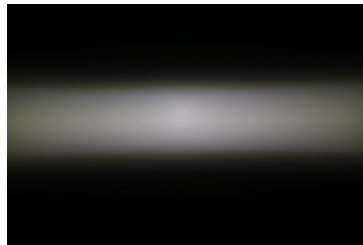

#### SEOUL SEMICONDUCTOR

LED Z8Y22P  
 FWHM / FWTM 104.0 + 10.0° / 160.0 + 17.0°  
 Efficiency 93 %  
 Peak intensity 2.3 cd/lm  
 LEDs/each optic 1  
 Light colour White  
 Required components:

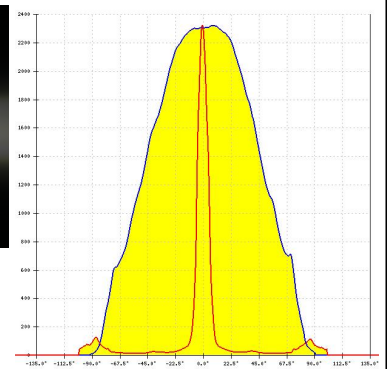
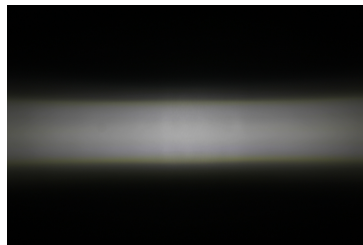

#### PHOTOMETRIC DATA (MEASURED):

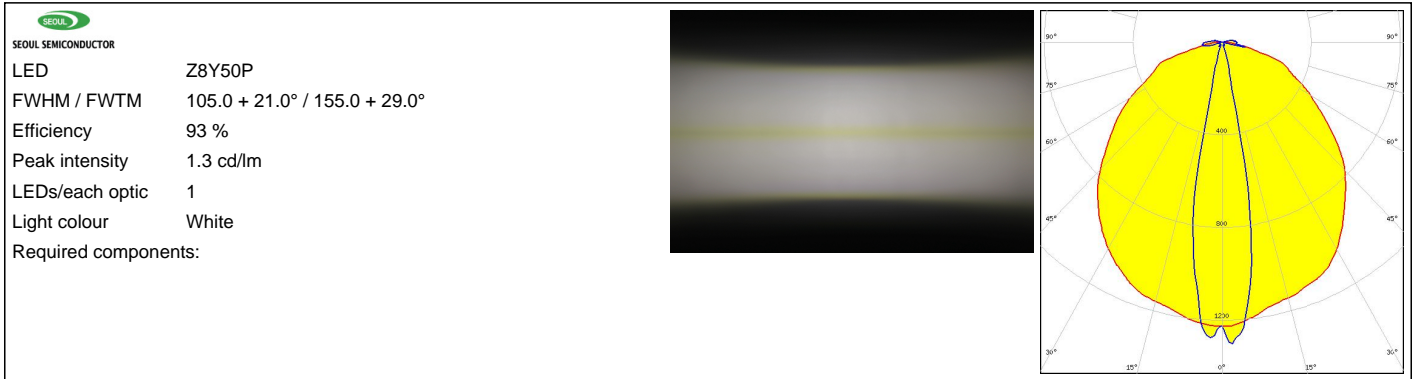

#### PHOTOMETRIC DATA (SIMULATED):



LED XD16  
 FWHM / FWTM 62.0 + 8.0° / 146.0 + 15.0°  
 Efficiency 94 %  
 Peak intensity 3.2 cd/lm  
 LEDs/each optic 1  
 Light colour White  
 Required components:

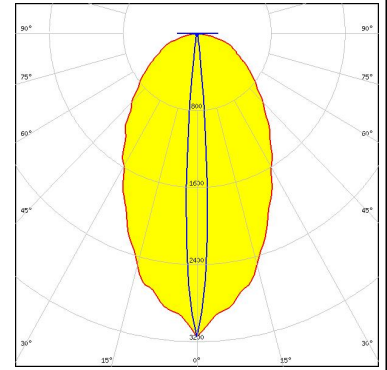

LED XHP35 HD  
 FWHM / FWTM 89.0 + 14.0° / 139.0 + 20.0°  
 Efficiency 91 %  
 Peak intensity 2.2 cd/lm  
 LEDs/each optic 1  
 Light colour White  
 Required components:

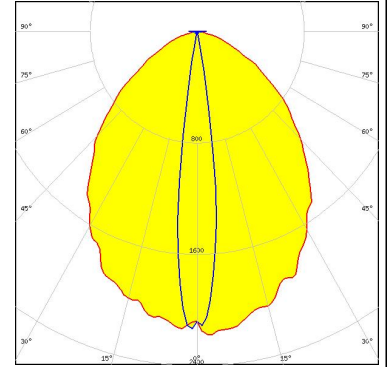

LED XHP35 HI  
 FWHM / FWTM 82.0 + 10.0° / 136.0 + 15.0°  
 Efficiency 93 %  
 Peak intensity 3.2 cd/lm  
 LEDs/each optic 1  
 Light colour White  
 Required components:

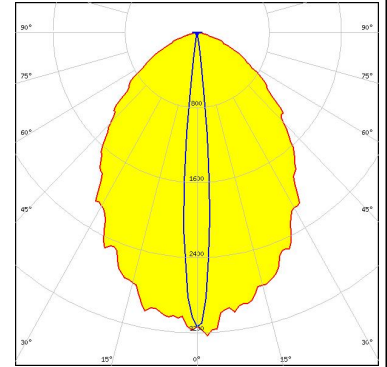

LED XP-E2  
 FWHM / FWTM 6.0 + 41.0° / 13.0 + 109.0°  
 Efficiency 94 %  
 Peak intensity 5.6 cd/lm  
 LEDs/each optic 1  
 Light colour White  
 Required components:

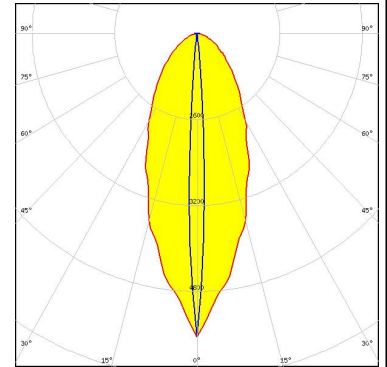



#### PHOTOMETRIC DATA (SIMULATED):

##### LUMILEDS

LED LUXEON CZ  
 FWHM / FWTM 4.0 + 34.0° / 10.0 + 107.0°  
 Efficiency 95 %  
 Peak intensity 7.1 cd/lm  
 LEDs/each optic 1  
 Light colour Red  
 Required components:

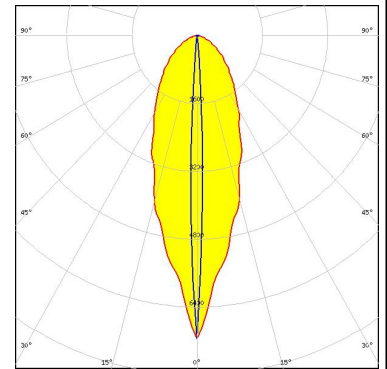

##### LUMILEDS

LED LUXEON H50-2  
 FWHM / FWTM 9.5 + 64.0° / 137.0°  
 Efficiency 92 %  
 Peak intensity 3.6 cd/lm  
 LEDs/each optic 1  
 Light colour White  
 Required components:

##### LUMILEDS

LED LUXEON Rubix  
 FWHM / FWTM 39.0 + 4.0° / 114.0 + 10.0°  
 Efficiency 96 %  
 Peak intensity 7 cd/lm  
 LEDs/each optic 1  
 Light colour Red  
 Required components:

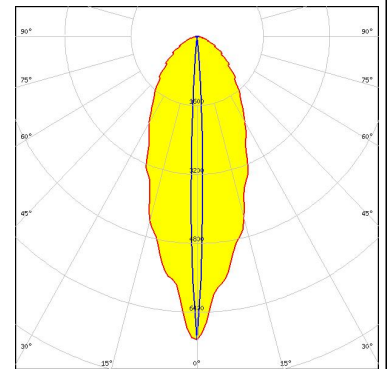

##### LUMILEDS

LED LUXEON Rubix  
 FWHM / FWTM 41.0 + 4.0° / 118.0 + 10.0°  
 Efficiency 96 %  
 Peak intensity 6.6 cd/lm  
 LEDs/each optic 1  
 Light colour Green  
 Required components:

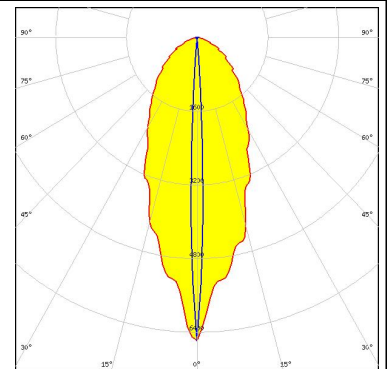

#### PHOTOMETRIC DATA (SIMULATED):

<p><b>LUMILEDS</b></p> <p>LED: LUXEON Rubix</p> <p>FWHM / FWTM: 41.0 + 4.0° / 118.0 + 10.0°</p> <p>Efficiency: 96 %</p> <p>Peak intensity: 6.7 cd/lm</p> <p>LEDs/each optic: 1</p> <p>Light colour: Blue</p> <p>Required components:</p>	
<p><b>LUMILEDS</b></p> <p>LED: LUXEON Rubix</p> <p>FWHM / FWTM: 40.0 + 4.0° / 117.0 + 10.0°</p> <p>Efficiency: 96 %</p> <p>Peak intensity: 6.7 cd/lm</p> <p>LEDs/each optic: 1</p> <p>Light colour: White</p> <p>Required components:</p>	
<p><b>NICHIA</b></p> <p>LED: NCSxE17A</p> <p>FWHM / FWTM: 90.0 + 9.0° / 150.0 + 18.0°</p> <p>Efficiency: 94 %</p> <p>Peak intensity: 3.1 cd/lm</p> <p>LEDs/each optic: 1</p> <p>Light colour: White</p> <p>Required components:</p>	
<p><b>OSRAM</b> Opto Semiconductors</p> <p>LED: OSOLON Square EC</p> <p>FWHM / FWTM: 8.0 + 53.0° / 116.0 + 15.0°</p> <p>Efficiency: 94 %</p> <p>Peak intensity: 4 cd/lm</p> <p>LEDs/each optic: 1</p> <p>Light colour: White</p> <p>Required components:</p>	

#### PHOTOMETRIC DATA (SIMULATED):

#### OSRAM

Opto Semiconductors

LED OSLOM SSL 150  
 FWHM / FWTM 6.0 + 58.0° / 12.0 + 131.0°  
 Efficiency 94 %  
 Peak intensity 4.7 cd/lm  
 LEDs/each optic 1  
 Light colour Red  
 Required components:

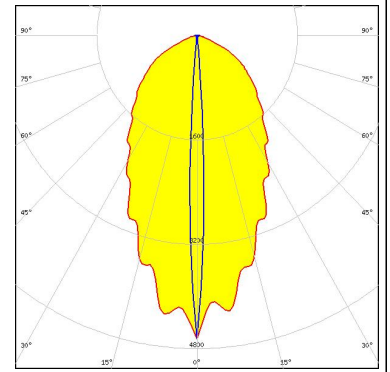

#### SAMSUNG

LED LH351B  
 FWHM / FWTM 67.0 + 10.0° / 126.0 + 17.0°  
 Efficiency 94 %  
 Peak intensity 3.1 cd/lm  
 LEDs/each optic 1  
 Light colour White  
 Required components:

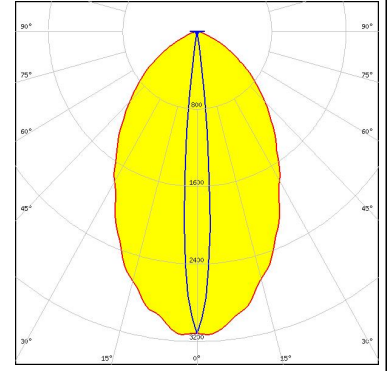

#### SAMSUNG

LED LH351C  
 FWHM / FWTM 71.0 + 11.0° / 126.0 + 18.0°  
 Efficiency 94 %  
 Peak intensity 3 cd/lm  
 LEDs/each optic 1  
 Light colour White  
 Required components:

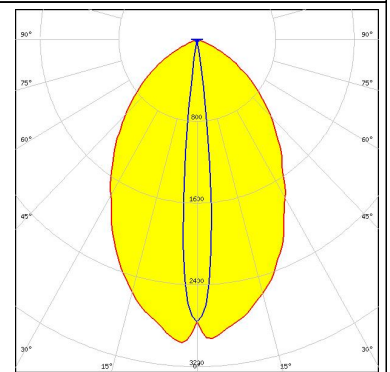

#### GENERAL INFORMATION:

NOTE: The typical beam angle will be changed by different color, chip size and chip position tolerance. The typical total beam angle is the full angle measured where the luminous intensity is half of the peak value.

#### MATERIALS:

As part of our continuous research and improvement processes, and to ensure the best possible quality and availability of our products, LEDiL reserves the right to change material grades without notice.

#### PRODUCT DATA USER AGREEMENT AND DISCLAIMER:

The measured data in the provided downloadable LEDiL Product Datasheets and Mechanical 2D-Drawings is rounded and provided as reference for planning. LEDiL Oy's optical specifications have been verified by conducting performance testing of the products in accordance with the company's quality system. The reported data are averaged results of multiple measurements with typical variation. LEDiL Oy reserves the right to without prior notification make changes and improvements to its products.

LEDiL Oy assumes neither warranty, nor guarantee nor any other liability of any kind for the contents and correctness of the provided data. The provided data has been generated with highest diligence but the provided data may in reality not represent the complete possible variation range of all intrinsic parameters. Therefore, in certain cases a deviation from the provided data could occur.

LEDiL Oy reserves the right to undertake technical changes of its products without further notification which could lead to changes in the provided data. LEDiL Oy assumes no liability of any kind for the possible deviation from any provided data or any other damage resulting from the usage of the provided data.

The user agrees to this disclaimer and user agreement with the download or usage of the provided files.

#### LEDiL Oy

Joensuunkatu 13  
FI-24240 SALO  
Finland

#### LEDiL Inc.

228 West Page Street  
Suite D  
Sycamore IL 60178  
USA

#### Ledil Optics Technology (Shenzhen) Co., Ltd.

# 405 , Block B  
Casic Motor Building  
Shenzhen 518057  
P.R.CHINA

#### Local sales and technical support

[www.ledil.com/  
where\\_to\\_buy](http://www.ledil.com/where_to_buy)

#### Shipping locations

Salo, Finland  
Hong Kong, China

#### Distribution Partners

[www.ledil.com/  
where\\_to\\_buy](http://www.ledil.com/where_to_buy)