



# TF037C

## MICRO BLOWERS

### FEATURES

- Aerodynamic bearings
- Compact / Light weight
- High static pressures
- Low vibration
- Long life due to aerodynamic bearings without heat dependence
- Two type available with or without Fixing Leg
- Resin in full compliance with UL94 V0



### STANDARD SPECIFICATIONS

● Unless otherwise specified, the environmental conditions are 23°C±5°C, normal humidity, and atmospheric pressure range 90 to 106 kPa.

No.	Item	Part number	TF037C-2100-F	TF037C-2000-F	Remarks
1	Operating Voltage Range		10~30 V		
2	Direction of Rotation		(Counterclockwise viewing from the air vent side)		
3	Kind of Gas		Normal Air		Do not use to any corrosive gas.
4	Type of Motor		3 phase 8 pole Brushless (Y Connection)		
5	Number of Poles		8 Poles (4 pole pairs)		
6	Bearing Type		Aero Dynamic Bearing		
7	Recommended Mounting Position		Axis Vertical (Plate Downward)		Avoid vibration and shock while the product is operating. It may damage product
8	Maximum Input Coil Current		3.0 A Max.		In case, the rotor is lock up, the coil may be destroyed by surge current. The protection circuit to prevent surge current must be installed for safety.
9	Power Supply Current		0.9 A Max.		at 3.0 kPa 100 L/min Temperature: 23±5°C, Humidity: 45~85%RH, Air Pressure: 101.3 kPa
10	Power Consumption		21.6 W Max.		
11	Minimum Flowrate		5 L/min		
12	Torque Constant		0.0025 N·m/A		
13	Rotation Speed Range		6,000~45,000 rpm		Rotation Speed = Hole Sensor Frequency×15

# TF037C

## MICRO BLOWERS

No.	Item	Part number	TF037C-2100-F	TF037C-2000-F	Remarks
14	Acoustic Audible Noise		at 3.0 kPa 100 L/min Temperature:23±5°C, Humidity:45~85%RH, Air Pressure:101.3 kPa		Measured 1 m away from the intake vent (Including dark noise as 15 dB)
15	Coil Resistance		0.5 Ω		at 20°C (Between 2 phase)
16	Coil Inductance		20 μH		at 20°C, 10 kHz (Between 2 phase)
17	Insulation Pressure Resistance		E grade (JIS C 4003 Cable for Coil)		
18	Insulation Resistance		20 MΩ Min. between Coil terminal and Plate at 500V DC(JIS C 4003)		
19	Insulation Pressure Resistance		Leak Current: 1 mA Max.		At min 600 VAC between coil terminal and plate more than one second
20	Fixing Leg		With	Without	
21	Weight		94 g	90 g	Reference value
22	Rotor Inertia		2.1×10 <sup>-6</sup> kg·m <sup>2</sup>		
23	Operating Temperature And Humidity		-10~60°C, 10~95%RH		Condensation may cause damage to product.
24	Storage Temperature Humidity range		-20~60°C, 10~95%RH		Condensation may cause damage to product.
25	Operating Ambient Pressure		770~1,060 hPa		

### OPERATING RANGE IN P-Q & Q-I RATING

- P-Q and Q-I conditions must not exceed the ratings listed below.
- The general purpose driver TF037E-1000-D is setup to the configuration for general use. In using the general purpose driver, the output may not reach the maximum ratings listed below.
- P-Q and Q-I characteristics are for reference purpose only. The driver must be configured properly by measuring the actual condition before use.

※ The characteristics below are measured with our company's driver at axis vertical position.

※ Ambient Temperature : 25°C, Barometric Pressure: 101.3 kPa

#### Characteristics at 12 V P-Q/Q-I

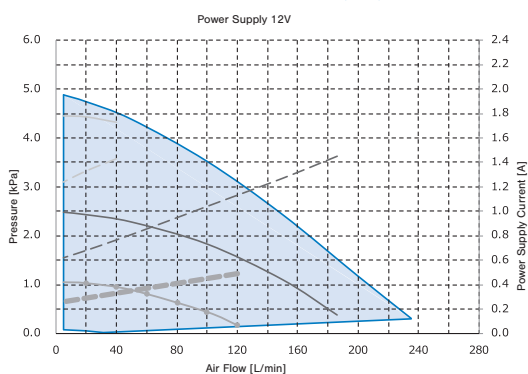

#### Characteristics at 24 V P-Q/Q-I

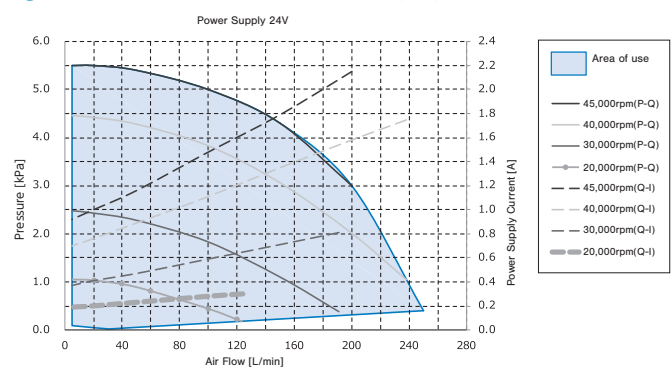

# TF037C

## MICRO BLOWERS

### CONNECTOR

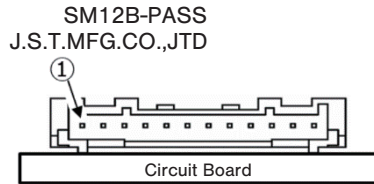

### HARNESS SIDE

J.S.T.MFG.CO.,JTD SM12B-PASS	
Pressure Welding	12PAF-6S (Retainer: PAFS-12V-S)
Crimping	PAP-12V-S (Contact: SPHD-001T-P0.5)

- Both pressure welding and crimping are available.
- Recommended size: AWG#22

### TERMINAL ARRAY

Pin No.	Symbol	Content
①	Vcc	Power for Hall Sensor
②	H2-	Output of Hall 2
③	H2+	
④	H3-	Output of Hall 3
⑤	H3+	
⑥	H1-	Output of Hall 1
⑦	H1+	
⑧	GND	GND
⑨	TH	Thermistor
⑩	V	Coil (V)
⑪	W	Coil (W)
⑫	U	Coil (U)

### INTERNAL CIRCUIT / LIMITING RESISTOR

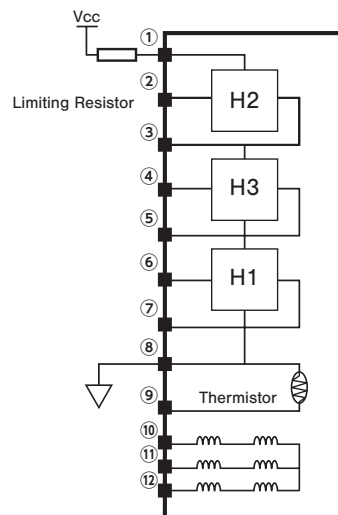

### TIMING CHART

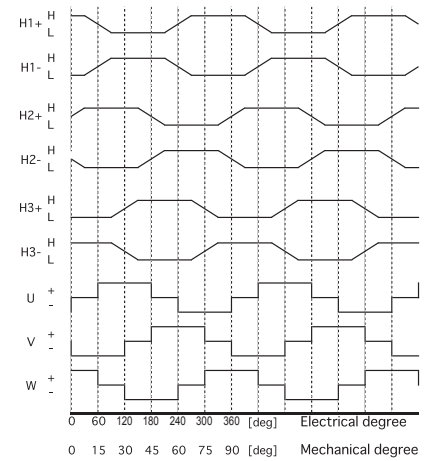

- The current into the hall sensor must be restricted within the rating listed below by using a resistor.

### HALL SENSOR CHARACTERISTIC

Input Current	10 mA Max.	At maximum operating load at temperature 60°C
Input Resistance	250~450 Ω	Per one Hall sensor
Differential Output	300 mV p-p Min.	VH = (VH+)-(VH-) at 10 mA in Input current

• Equivalent of ASAHI KASEI Electronics HW-105A

### THERMISTOR CHARACTERISTIC

Reference Resistance 25°C	10 kΩ
Operating Current 25°C	0.31 mA
B Constant[25/85°C]	4,100 K
Maximum Temperature	86°C (Thermistor Resistance : 0.97 kΩ)

• Equivalent of TDK NTCG164BH103JT



# TF037C

## MICRO BLOWERS

### MARKING

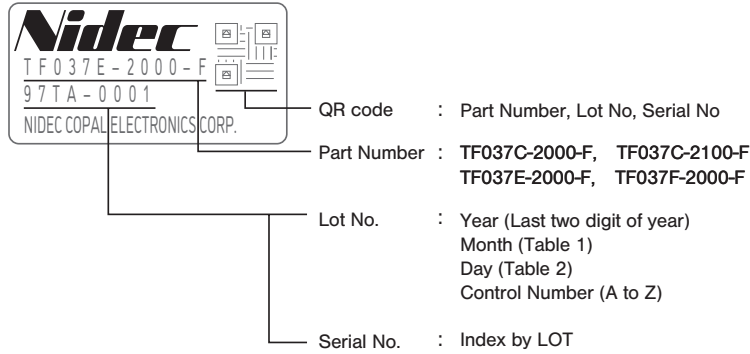

[Table 1]

Month	1	2	3	4	5	6	7	8	9	10	11	12
No.	1	2	3	4	5	6	7	8	9	O	N	D

[Table 2]

Day	1	2	3	4	5	6	7	8	9	10	11	12	13	14	15	16	17	18	19	20
No.	1	2	3	4	5	6	7	8	9	A	B	C	D	E	F	G	H	J	K	L

  

Day	21	22	23	24	25	26	27	28	29	30	31
No.	M	N	P	Q	R	T	U	V	W	X	Y

### Micro Blower Kit with driver

For the model with mounting brackets "TF037C-2100-F", Kits with driver and wire harness for the blower available. They will help customers shorten their evaluation and product development times.

#### Kit Part Number : TF037C-2100-P

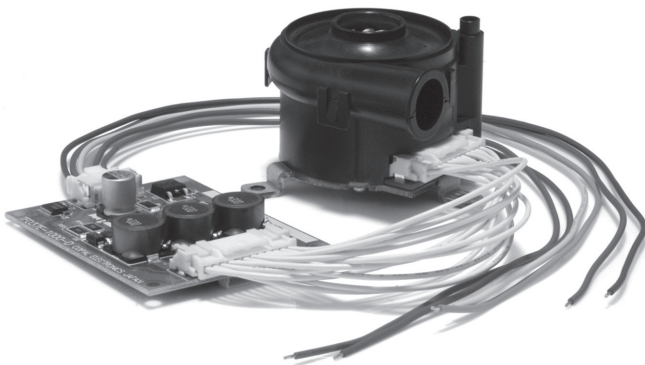

List of the kit	
1	Micro Blower (TF037C-2100-F)
2	Driver (series common)
3	Wire Harness (for Driver-Blower connection)
4	Wire Harness (for Driver-Power connection)

The Drivers are sold separately as an optional item. (Ref.P430)