

## Low Voltage, 0.6 Ω, Dual SPDT Analog Switch

### DESCRIPTION

The DG2735A is a low voltage, low on-resistance, dual single-pole/double-throw (SPDT) monolithic CMOS analog switch designed for high performance switching of analog signals. Combining low-power, high speed, low on-resistance, and small package size, the DG2735A, is ideal for portable and battery powered applications.

The DG2735A has an operation range from 1.65 V to 5.5 V single supply. The DG2735A has two separate control pins for independent control of the two SPDT switches.

The DG2735A is guaranteed 1.65 V logic compatible, allowing easy interface with low voltage DSP or MCU control logic and ideal for one cell Li-ion battery direct power.

The switch conducts signals within the power rails equally well in both directions when on, and blocks up to the power supply level when off. Break-before-make is guaranteed.

The DG2735A is built on Vishay Siliconix's sub micron CMOS low voltage process technology and provides greater than 400 mA latch-up protection, as tested per JESD78A.

As a committed partner to the community and the environment, Vishay Siliconix manufactures this product with lead (Pb)-free device terminations. DG2735A is offered in a miniQFN package. The miniQFN package has a nickel-palladium-gold device termination and is represented by the lead (Pb)-free "-GE4" suffix. The nickel-palladium-gold device terminations meet all JEDEC® standards for reflow and MSL ratings.

### FEATURES

- Low voltage operation (1.65 V to 5.5 V)
- Low on-resistance -  $R_{ON}$ : 0.5 Ω at 2.7 V
- Fast switching:  $t_{ON}$  = 55 ns at 2.7 V
- $T_{OFF}$  = 15 ns at 2.7 V
- Latch-up current > 400 mA (JESD78)
- Material categorization: for definitions of compliance please see [www.vishay.com/doc?99912](http://www.vishay.com/doc?99912)



**RoHS**  
COMPLIANT  
HALOGEN  
**FREE**

### BENEFITS

- Reduced power consumption
- High accuracy
- Reduce board space
- TTL/1.65 V logic compatible

### APPLICATIONS

- Cellular phones
- Speaker headset switching
- Audio and video signal routing
- PCMCIA cards
- Battery operated systems
- Portable media players
- Handheld test instruments

### FUNCTIONAL BLOCK DIAGRAM AND PIN CONFIGURATION

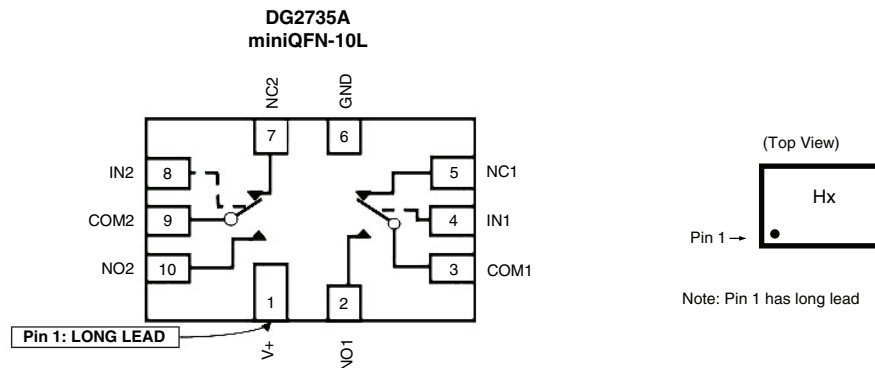

Device Marking: Hx for DG2735A  
x = Date/Lot Traceability Code

TRUTH TABLE		
LOGIC	NC1, 2	NO1, 2
0	ON	OFF
1	OFF	ON



ORDERING INFORMATION					
PART NUMBER	CONFIGURATION	SWITCH FUNCTION	TEMP. RANGE	PACKAGE	REEL QUANTITY
DG2735ADN-T1-GE4	Dual DPST	NC / NO	-40 °C to +85 °C	miniQFN10, 1.4 mm x 1.8 mm	3000

ABSOLUTE MAXIMUM RATINGS (T <sub>A</sub> = 25 °C, unless otherwise noted)				
PARAMETER	SYMBOL		LIMIT	UNIT
Reference to GND	V+		-0.3 V to +6 V	V
	IN, COM, NC, NO <sup>a</sup>		-0.3 V to (V+ + 0.3)	
Current (Any terminal except NO, NC or COM)			30	mA
Continuous Current (NO, NC, or COM)			± 300	
Peak Current (Pulsed at 1 ms, 10 % duty cycle)			± 500	
Storage Temperature (D Suffix)			-65 to +150	°C
Power Dissipation (Packages) <sup>b</sup>	miniQFN10 <sup>c</sup>		208	mW
Latch Up Current	JESD78A		>400	mA
ESD - HBM	ANSI / ESDA / JEDEC JS-001		>5000	V
ESD - CDM	JESD22-C101		>1000	
ESD - MM	JESD22-A115		>200	

**Notes**

- a. Signals on NC, NO, or COM or IN exceeding V+ will be clamped by internal diodes. Limit forward diode current to maximum current ratings.
- b. All leads welded or soldered to PC board.
- c. Derate 4 mW/C above 70 °C.

SPECIFICATIONS (V+ = 3 V)							
PARAMETER	SYMBOL	TEST CONDITIONS UNLESS OTHERWISE SPECIFIED V+ = 3 V, ± 10 %, V <sub>IN</sub> = 0.4 V or 1.65 V <sup>e</sup>	TEMP. <sup>a</sup>	LIMITS -40 °C to +85 °C			UNIT
				MIN. <sup>b</sup>	TYP. <sup>c</sup>	MAX. <sup>b</sup>	
<b>Analog Switch</b>							
Analog Signal Range <sup>d</sup>	V <sub>analog</sub>	R <sub>DS(on)</sub>	Full	0	-	V+	V
On-Resistance	R <sub>DS(on)</sub>	V+ = 2.7 V, I <sub>NO/NC</sub> = 100 mA, V <sub>COM</sub> = 0.5 V	Room	-	0.5	0.7	Ω
		V+ = 2.7 V, I <sub>NO/NC</sub> = 100 mA, V <sub>COM</sub> = 1.5 V					
		V+ = 2.7 V, I <sub>NO/NC</sub> = 100 mA, V <sub>COM</sub> = 0.5 V	Full	-	0.6	-	
		V+ = 2.7 V, I <sub>NO/NC</sub> = 100 mA, V <sub>COM</sub> = 1.5 V					
		V+ = 5.5 V, I <sub>NO/NC</sub> = 100 mA, V <sub>COM</sub> = 0.9 V	Room	-	0.3	0.5	
		V+ = 5.5 V, I <sub>NO/NC</sub> = 100 mA, V <sub>COM</sub> = 2.5 V					
		V+ = 5.5 V, I <sub>NO/NC</sub> = 100 mA, V <sub>COM</sub> = 0.9 V	Full	-	0.4	-	
		V+ = 5.5 V, I <sub>NO/NC</sub> = 100 mA, V <sub>COM</sub> = 2.5 V					
R <sub>ON</sub> Match <sup>d</sup>	ΔR <sub>ON</sub>	V+ = 2.7 V, I <sub>NO/NC</sub> = 100 mA, V <sub>COM</sub> = 0.5 V, 1.5 V V+ = 5.5 V, I <sub>NO/NC</sub> = 100 mA, V <sub>COM</sub> = 0.9 V, 2.5 V	Room	-	0.06	0.08	
R <sub>ON</sub> resistance flatness <sup>d</sup>	R <sub>ON</sub> flatness	V+ = 2.7 V, I <sub>NO/NC</sub> = 100 mA, V <sub>COM</sub> = 0.5 V, 1.5 V	Room	-	-	0.15	
Switch Off Leakage Current	I <sub>NO/NC(off)</sub>	V+ = 5 V, V <sub>NO/NC</sub> = 0.5 V/4.5 V, V <sub>COM</sub> = 4.5 V/0.5 V	Room	-8	-	8	nA
			Full	-50	-	50	
	Room		-8	-	8		
	Full		-50	-	50		
Channel-On Leakage Current	I <sub>COM(on)</sub>	V+ = 5 V, V <sub>NO/NC</sub> = V <sub>COM</sub> = 4.5 V/0.5 V	Room	-10	-	10	
			Full	-50	-	50	



SPECIFICATIONS (V+ = 3 V)							
PARAMETER	SYMBOL	TEST CONDITIONS UNLESS OTHERWISE SPECIFIED V+ = 3 V, ± 10 %, V <sub>IN</sub> = 0.4 V or 1.65 V <sup>e</sup>	TEMP. <sup>a</sup>	LIMITS -40 °C to +85 °C			UNIT
				MIN. <sup>b</sup>	TYP. <sup>c</sup>	MAX. <sup>b</sup>	
<b>Digital Control</b>							
Input High Voltage	V <sub>INH</sub>		Full	1.65	-	-	V
Input Low Voltage	V <sub>INL</sub>		Full	-	-	0.4	
Input Capacitance	C <sub>IN</sub>		Full	-	6	-	pF
Input Current	I <sub>INL</sub> or I <sub>INH</sub>	V <sub>IN</sub> = 0 or V+	Full	-1	-	1	µA
<b>Dynamic Characteristics</b>							
Break-Before-Make Time <sup>e</sup>	t <sub>BBM</sub>	V+ = 3.6 V, V <sub>NO</sub> , V <sub>NC</sub> = 1.5 V, R <sub>L</sub> = 50 Ω, C <sub>L</sub> = 35 pF	Room	1	15	-	ns
Turn-On Time <sup>e</sup>	t <sub>ON</sub>		Room	-	28	78	
			Full	-	-	80	
Turn-Off Time <sup>e</sup>	t <sub>OFF</sub>		Room	-	13	58	
		Full	-	-	60		
Off-Isolation <sup>d</sup>	OIRR	R <sub>L</sub> = 50 Ω, C <sub>L</sub> = 5 pF, f = 100 kHz	Room	-	-70	-	dB
Crosstalk <sup>d</sup>	X <sub>TALK</sub>		-	-90	-		
3dB bandwidth <sup>d</sup>		R <sub>L</sub> = 50 Ω, C <sub>L</sub> = 5 pF	Room	-	120	-	MHz
NO, NC Off Capacitance <sup>d</sup>	C <sub>NO(off)</sub>	V <sub>IN</sub> = 0 V, or V+, f = 1 MHz	Room	-	40	-	pF
	C <sub>NC(off)</sub>			-	40	-	
Channel On Capacitance <sup>d</sup>	C <sub>NO(on)</sub>			-	120	-	
	C <sub>NC(on)</sub>			-	120	-	
<b>Power Supply</b>							
Power Supply Range	V+		-	1.65	-	5.5	V
Power Supply Current	I+	V <sub>IN</sub> = 0 or V+	Full	-	-	1	µA

**Notes**

- a. Room = 25 °C, Full = as determined by the operating suffix.
- b. The algebraic convention whereby the most negative value is a minimum and the most positive a maximum, is used in this data sheet.
- c. Typical values are for design aid only, not guaranteed nor subject to production testing.
- d. Guarantee by design, not subjected to production test.
- e. V<sub>IN</sub> = input voltage to perform proper function.

Stresses beyond those listed under "Absolute Maximum Ratings" may cause permanent damage to the device. These are stress ratings only, and functional operation of the device at these or any other conditions beyond those indicated in the operational sections of the specifications is not implied. Exposure to absolute maximum rating conditions for extended periods may affect device reliability.



**TYPICAL CHARACTERISTICS** ( $T_A = 25\text{ }^\circ\text{C}$ , unless otherwise noted)

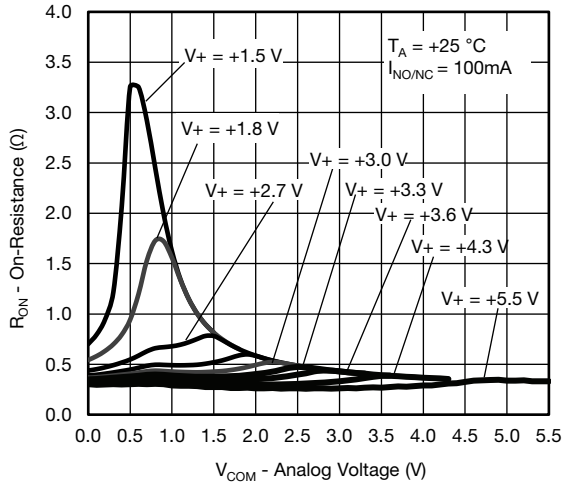

**RON vs. VCOM and Supply Voltage**

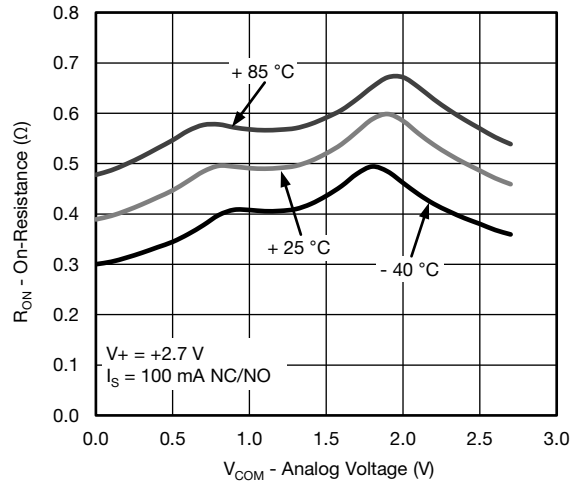

**RON vs. Analog Voltage and Temperature**

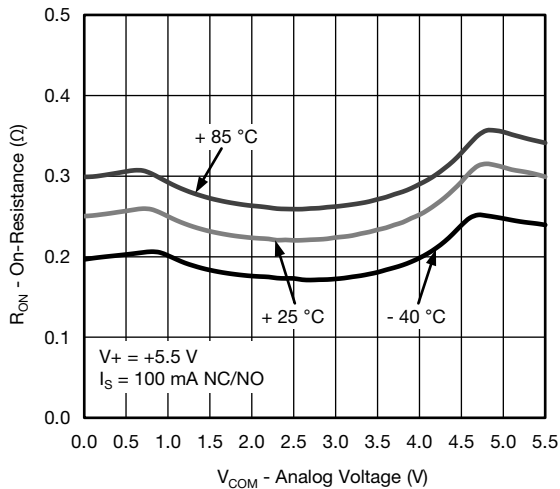

**RON vs. Analog Voltage and Temperature**

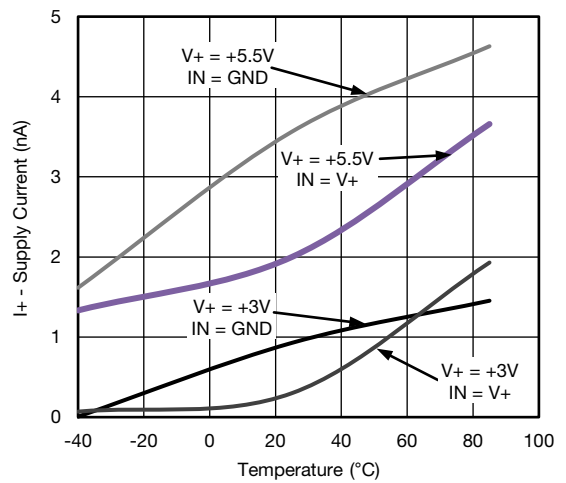

**Supply Current vs. Temperature**

**TYPICAL CHARACTERISTICS** ( $T_A = 25\text{ }^\circ\text{C}$ , unless otherwise noted)

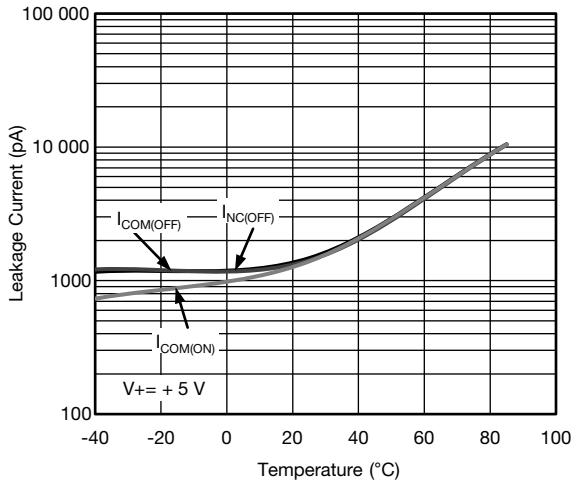

**Leakage Current vs. Temperature**



**Switching Time vs. Temperature**

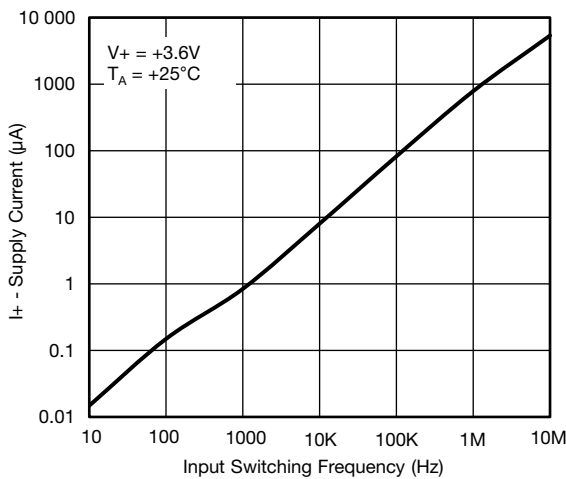

**Supply Current vs. Switching Frequency**

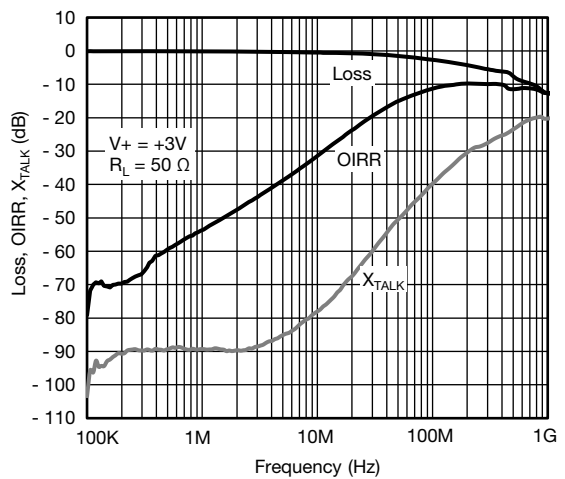

**Insertion Loss, Off-Isolation Crosstalk vs. Frequency**

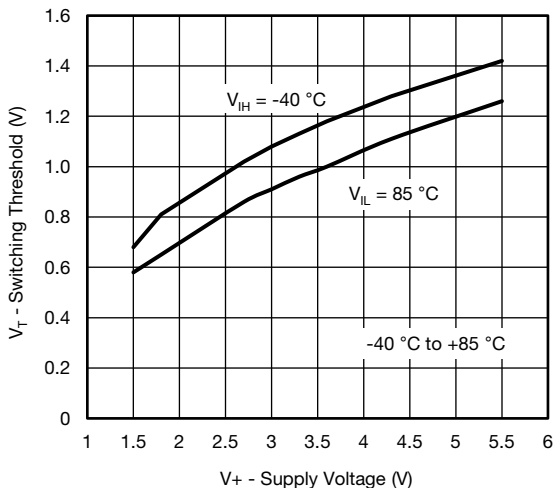

**Switching Threshold vs. Supply Voltage**



**Supply Current vs.  $V_{IN}$**

TEST CIRCUITS



$C_L$  (includes fixture and stray capacitance)

$$V_{OUT} = V_{COM} \left( \frac{R_L}{R_L + R_{ON}} \right)$$



Logic "1" = Switch On  
Logic input waveforms inverted for switches that have the opposite logic sense.

Fig. 1 - Switching Time



$C_L$  (includes fixture and stray capacitance)

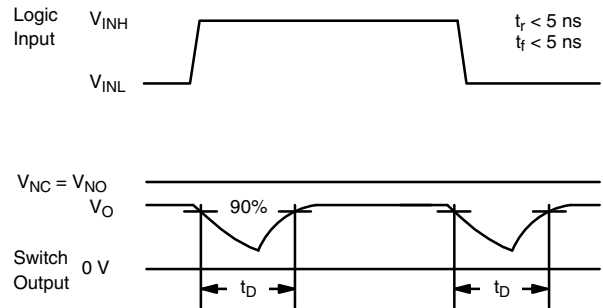

Fig. 2 - Break-Before-Make Interval

TEST CIRCUITS



IN depends on switch configuration: input polarity determined by sense of switch.

Fig. 3 - Charge Injection

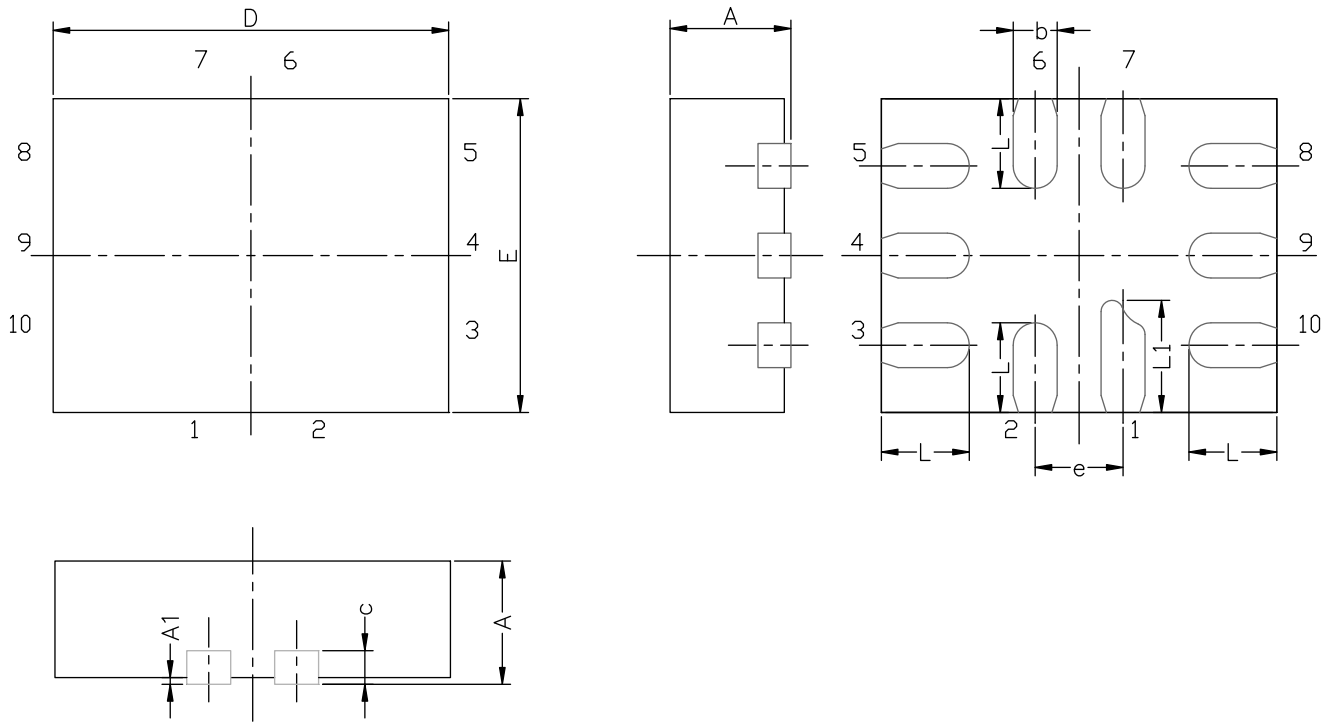

Fig. 4 - Off-Isolation



Fig. 5 - Channel Off/On Capacitance

Vishay Siliconix maintains worldwide manufacturing capability. Products may be manufactured at one of several qualified locations. Reliability data for Silicon Technology and Package Reliability represent a composite of all qualified locations. For related documents such as package/tape drawings, part marking, and reliability data, see [www.vishay.com/ppg?67590](http://www.vishay.com/ppg?67590).

**MINI QFN-10L CASE OUTLINE**

DIM	MILLIMETERS			INCHES		
	MIN.	NAM.	MAX.	MIN.	NAM.	MAX.
A	0.45	0.55	0.60	0.0177	0.0217	0.0236
A1	0.00	-	0.05	0.000	-	0.002
b	0.15	0.20	0.25	0.006	0.008	0.010
c	0.150 or 0.127 REF <sup>(1)</sup>			0.006 or 0.005 REF <sup>(1)</sup>		
D	1.70	1.80	1.90	0.067	0.071	0.075
E	1.30	1.40	1.50	0.051	0.055	0.059
e	0.40 BSC			0.016 BSC		
L	0.35	0.40	0.45	0.014	0.016	0.018
L1	0.45	0.50	0.55	0.0177	0.0197	0.0217

**Note**

<sup>(1)</sup> The dimension depends on the leadframe that assembly house used.

ECN T16-0163-Rev. B, 16-May-16  
DWG: 5957



**RECOMMENDED MINIMUM PADS FOR MINI QFN 10L**



Mounting Footprint  
Dimensions in mm (inch)



## **Disclaimer**

ALL PRODUCT, PRODUCT SPECIFICATIONS AND DATA ARE SUBJECT TO CHANGE WITHOUT NOTICE TO IMPROVE RELIABILITY, FUNCTION OR DESIGN OR OTHERWISE.

Vishay Intertechnology, Inc., its affiliates, agents, and employees, and all persons acting on its or their behalf (collectively, "Vishay"), disclaim any and all liability for any errors, inaccuracies or incompleteness contained in any datasheet or in any other disclosure relating to any product.

Vishay makes no warranty, representation or guarantee regarding the suitability of the products for any particular purpose or the continuing production of any product. To the maximum extent permitted by applicable law, Vishay disclaims (i) any and all liability arising out of the application or use of any product, (ii) any and all liability, including without limitation special, consequential or incidental damages, and (iii) any and all implied warranties, including warranties of fitness for particular purpose, non-infringement and merchantability.

Statements regarding the suitability of products for certain types of applications are based on Vishay's knowledge of typical requirements that are often placed on Vishay products in generic applications. Such statements are not binding statements about the suitability of products for a particular application. It is the customer's responsibility to validate that a particular product with the properties described in the product specification is suitable for use in a particular application. Parameters provided in datasheets and / or specifications may vary in different applications and performance may vary over time. All operating parameters, including typical parameters, must be validated for each customer application by the customer's technical experts. Product specifications do not expand or otherwise modify Vishay's terms and conditions of purchase, including but not limited to the warranty expressed therein.

Except as expressly indicated in writing, Vishay products are not designed for use in medical, life-saving, or life-sustaining applications or for any other application in which the failure of the Vishay product could result in personal injury or death. Customers using or selling Vishay products not expressly indicated for use in such applications do so at their own risk. Please contact authorized Vishay personnel to obtain written terms and conditions regarding products designed for such applications.

No license, express or implied, by estoppel or otherwise, to any intellectual property rights is granted by this document or by any conduct of Vishay. Product names and markings noted herein may be trademarks of their respective owners.