

350-W Interleaved PFC Pre-Regulator

User's Guide

350-W Interleaved PFC Pre-Regulator

User's Guide

Literature Number: SLUU228
September 2005

Contents

1	Introduction	6
2	Description	6
3	Thermal Requirements	6
4	Electrical Specifications	6
5	Schematic	7
6	Test Setup	8
7	Power Up/Power Down	9
8	Performance Data	9
	8.1 Input Ripple Current.....	11
	8.2 Startup Characteristics	12
	8.3 Line Dropout	13
	8.4 Line Transient.....	13
	8.5 2-W Auxiliary Supply (V_{bias})	14
9	Reference Design Assembly Drawing	15
10	Bill of Materials	16
	Important Notices	20

List of Figures

1	Auxiliary Supply and PFC Control Circuitry	7
2	PFC Pre-Regulator Power Stage	8
3	Test Setup	9
4	Efficiency vs. Output Power.....	10
5	PF vs. Output Power.....	10
6	Current THD vs. Output Power.....	10
7	Current Harmonics	10
8	Current Harmonics	10
9	Output Ripple Voltage at Full Load	11
10	Input Current and Inductor Currents	11
11	$V_{IN} = 85 \text{ V RMS}$, $P_{OUT} = 350 \text{ W}$	12
12	$V_{IN} = 265 \text{ V RMS}$, $P_{OUT} = 350 \text{ W}$	12
13	Start-Up at $V_{IN} = 120 \text{ V}$, $P_{OUT} = 350 \text{ W}$	12
14	Start-Up at $V_{IN} = 120 \text{ V}$, $P_{OUT} = 0 \text{ W}$	12
15	$V_{IN} = 120 \text{ V}$, $P_{OUT} = 350 \text{ W}$	13
16	Line Transient, $P_{OUT} = 350 \text{ W}$	13
17	Auxiliary Gate Drive and Current Sense Behavior at No Load.....	14
18	Auxiliary Output with 2-W Load, Gate Drive and Current Sense, $V_{OUT1} = 120 \text{ V}$	14
19	Auxiliary Output with 2-W Load, Gate Drive and Current Sense, $V_{OUT1} = 380 \text{ V}$	15
20	Top Assembly Layer	15
21	Bottom Assembly Layer	16

List of Tables

1	EVM Specifications	6
2	Parts List	16

350-W Interleaved PFC Pre-Regulator

1 Introduction

The evaluation module is a 350-W, two phase interleaved power factor corrected pre-regulator. This evaluation module has a 380-V, 350-W, dc output that operates off a universal input of (85 V to 265 V RMS) and provides power factor correction. The unit meets EN61000-3-2 class B input current harmonic specifications.

2 Description

The pre-regulator uses the UCC28528 PFC/PWM combination controller to shape the input current wave to provide power factor correction. This device also controls a 2-W auxiliary bias supply that can be used to control external circuitry. The UCC28220 interleaved PWM provides OVP protection and provides load sharing between the two interleaved boost converters.

3 Thermal Requirements

1. The evaluation module works up to 200 W without external cooling.
2. If the unit is to be run over 200 W, it requires a fan pointed directly at the converter heat sinks.
3. It is important to keep the ambient temperature around the components below 40°C.

4 Electrical Specifications

Table 1. EVM Specifications

	Parameter	Test Conditions	Min	Typ	Max	Unit
V _{IN}	Line input voltage		85		265	V _{RMS}
P _{OUT}	Output power		25		350	W
	Efficiency	350 W	90%			
V _{OUT}	Output voltage		375	380	400	V
THD	Total harmonic distortion	350 W			10%	

5 Schematic

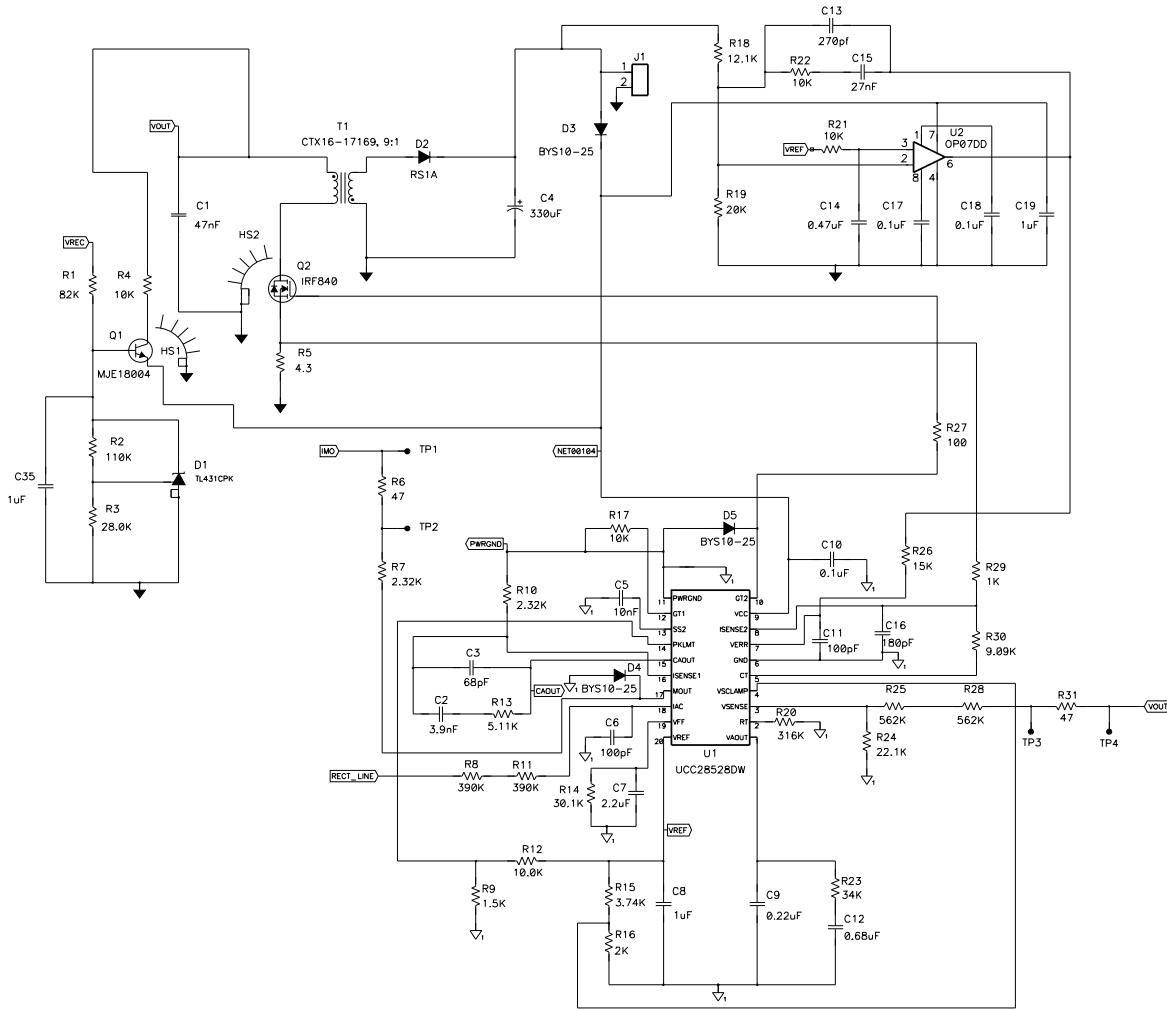

Figure 1. Auxiliary Supply and PFC Control Circuitry

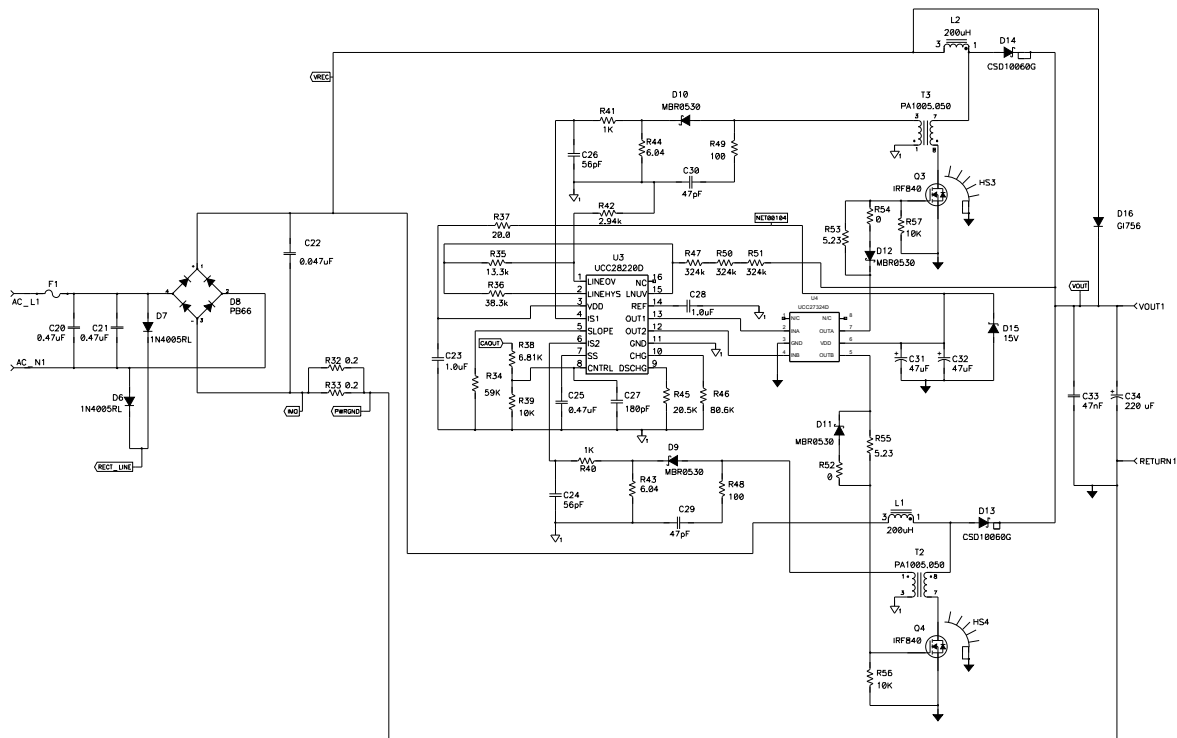

Figure 2. PFC Pre-Regulator Power Stage

6 Test Setup

There are high voltages present on the pre-regulator and it should only be handled by experienced power supply professionals. To evaluate this board as safely as possible the following test set up should be used. An isolation transformer should be connected between the source and unit. Before power is supplied, a volt meter and a resistive or electronic load should be attached to the unit's output.

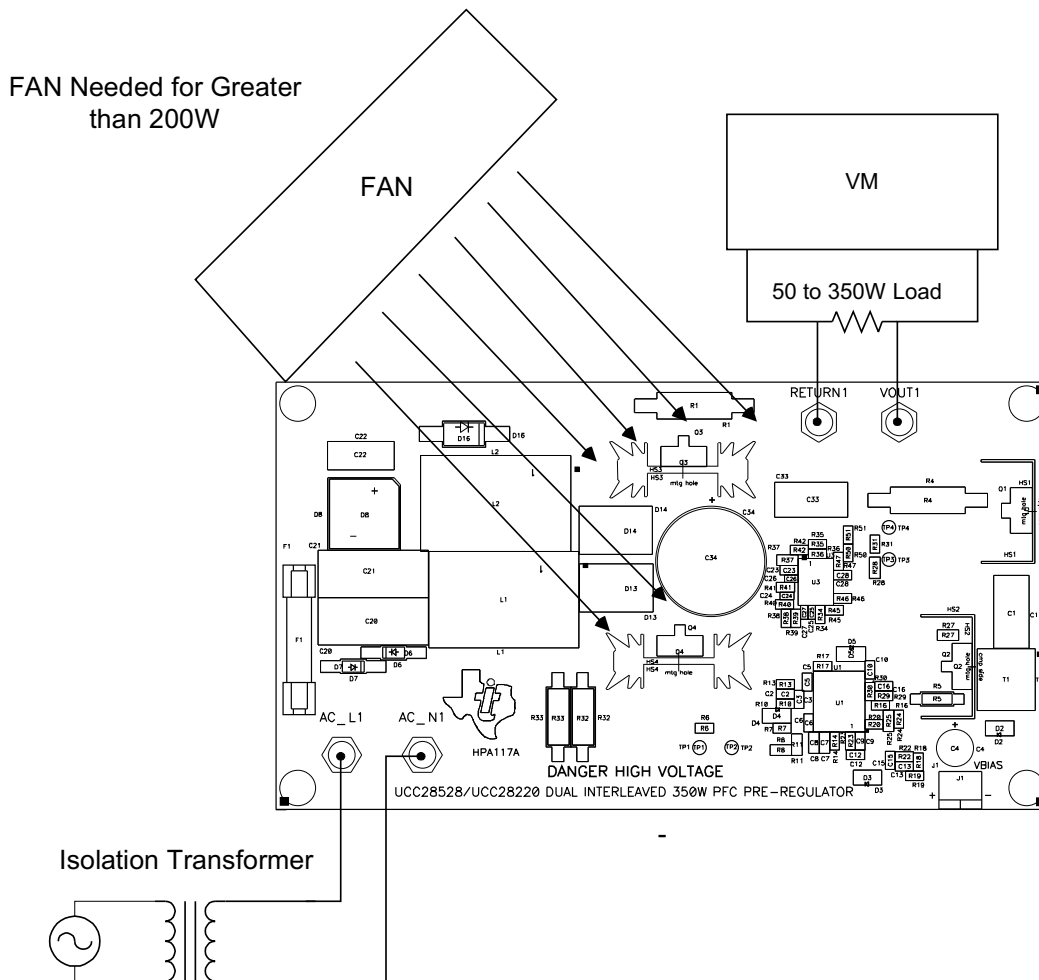

Figure 3. Test Setup

7 Power Up/Power Down

The unit will start up under no load conditions. However, for safety a load should be connected to the output of the device before it is powered up. The unit should also never be handled when power is applied to it or the output voltage is above 50V DC.

WARNING

There are very high voltages on the board and components can and do reach temperatures above 50°C so precautions must be taken in handling the board.

8 Performance Data

The efficiency of the boost pre-regulator is greater than 91% at 20% load. This converter in a normal system would be followed by a step down converter. The new +80 initiative requires the cascaded power supply be 80% efficient at 20% load. This can be accomplished by having the downstream converter being 90% efficient or greater. In high power applications, this can be accomplished with zero voltage switching (ZVS). An active clamp forward using a UCC2894 PWM or a phase shifted full bridge using the UCC2895 PWM could be used to design a step-down converter with greater than 90% efficiency for high power applications.

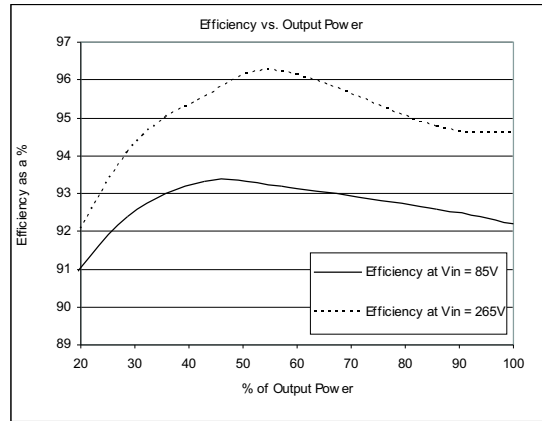

Figure 4. Efficiency vs. Output Power

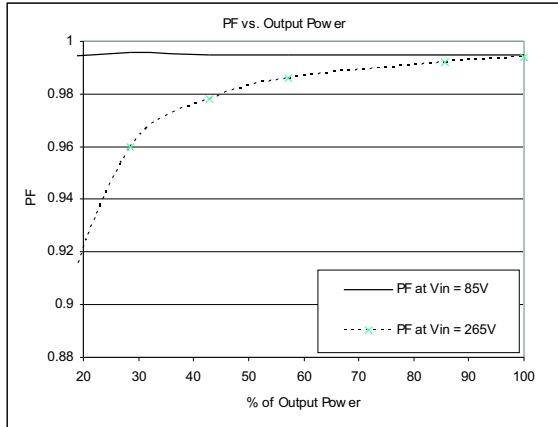

Figure 5. PF vs. Output Power

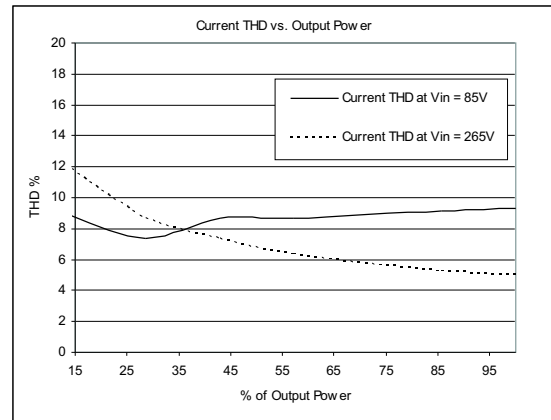

Figure 6. Current THD vs. Output Power

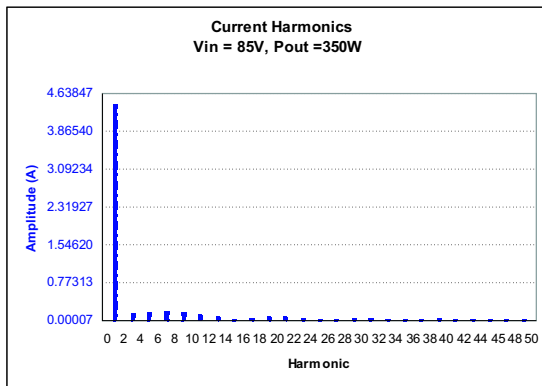

Figure 7. Current Harmonics

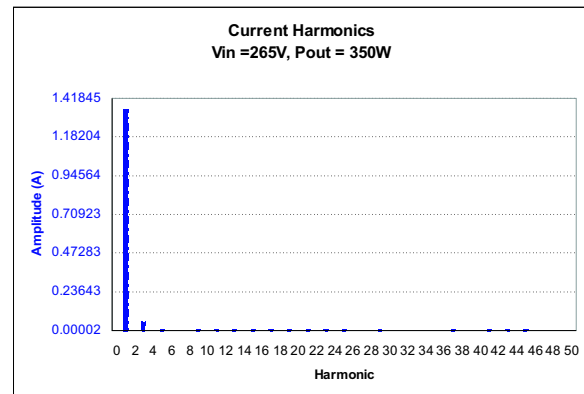

Figure 8. Current Harmonics

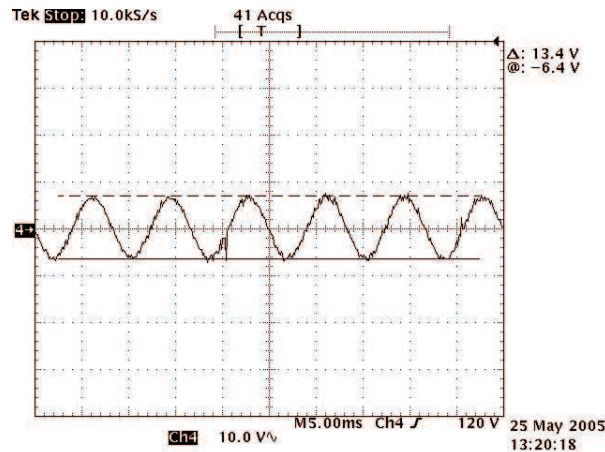

Figure 9. Output Ripple Voltage at Full Load

8.1 Input Ripple Current

Figure 10 shows that the inductor currents cancel each other out leaving the input current wave form clean. CH1 is the rectified line voltage, Ch2 is the inductor current from L1, CH3 is the inductor current of L2, Ch4 is the converter input current; CH1 is the rectified line voltage. Note the conversion ratio for the current waveform is 200 mA/mV.

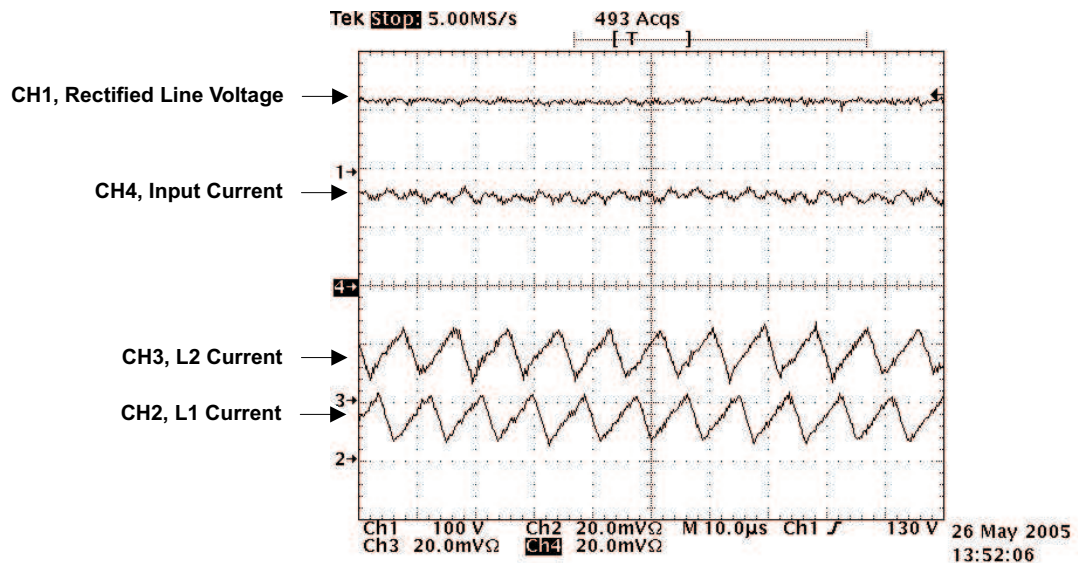

Figure 10. Input Current and Inductor Currents

Figure 11 and Figure 12 show the rectified line voltage (CH1), input current (CH4), and L1 and L2 inductor currents CH2 and CH3 respectively, at maximum load with different line conditions. From these waveforms, it can be observed that the inductor ripple currents are canceling each other out due to the interleaving.

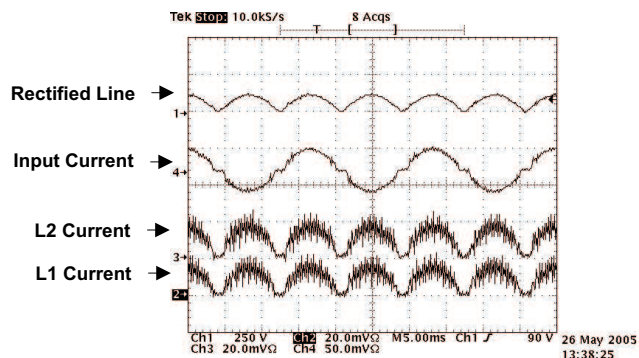

Figure 11. $V_{IN} = 85 \text{ V RMS}$, $P_{OUT} = 350 \text{ W}$

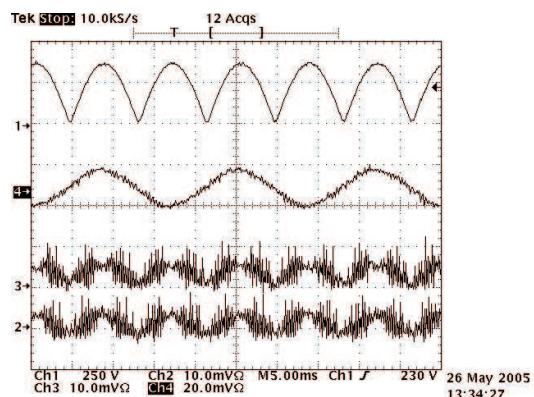

Figure 12. $V_{IN} = 265 \text{ V RMS}$, $P_{OUT} = 350 \text{ W}$

8.2 Startup Characteristics

PFC pre-regulators have a tendency to overshoot during power up. This is due to the voltage loop crossing over at 10 Hz. However, the UCC28528 uses a slew rate comparator that speeds up transient response and reduces overshoot. Figure 13 and Figure 14 show the startup behavior of the EVM at 120-V RMS input at maximum and no load conditions. CH4 is the output voltage and CH3 is the input current. From these figures, it can be observed that there is very little overshoot during startup.

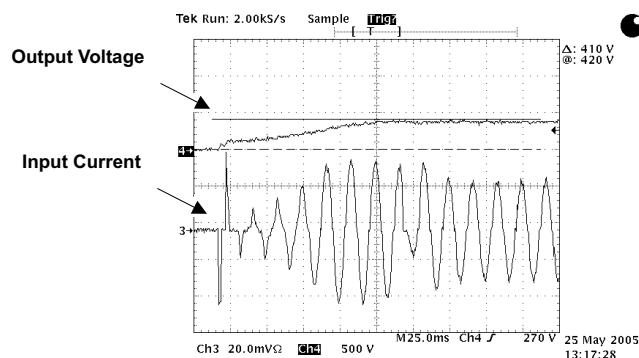

Figure 13. Start-Up at $V_{IN} = 120 \text{ V}$, $P_{OUT} = 350 \text{ W}$

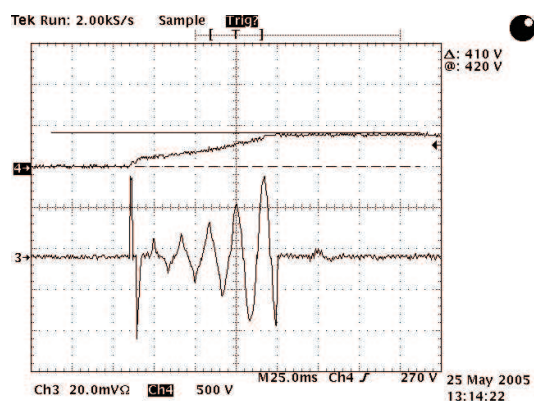

Figure 14. Start-Up at $V_{IN} = 120 \text{ V}$, $P_{OUT} = 0 \text{ W}$

8.3 Line Dropout

The unit was tested under a line dropout condition and the unit came back into regulation within 100 ms. Refer to [Figure 15](#) for details. CH1 is the rectified input voltage and CH2 is the output voltage.

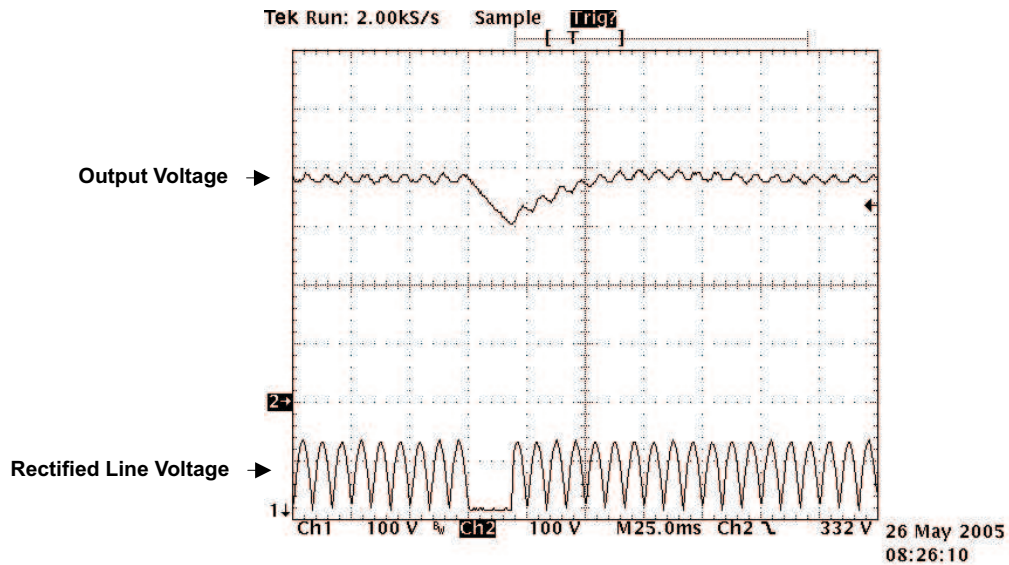

Figure 15. $V_{IN} = 120\text{ V}$, $P_{OUT} = 350\text{ W}$

8.4 Line Transient

A line transient test was conducted with an ac source on the reference design. The line was varied from 120 to 240-V RMS and the transient response was evaluated. From the oscilloscope output shown in [Figure 16](#) it can be observed that the output recovered within 200 ms.

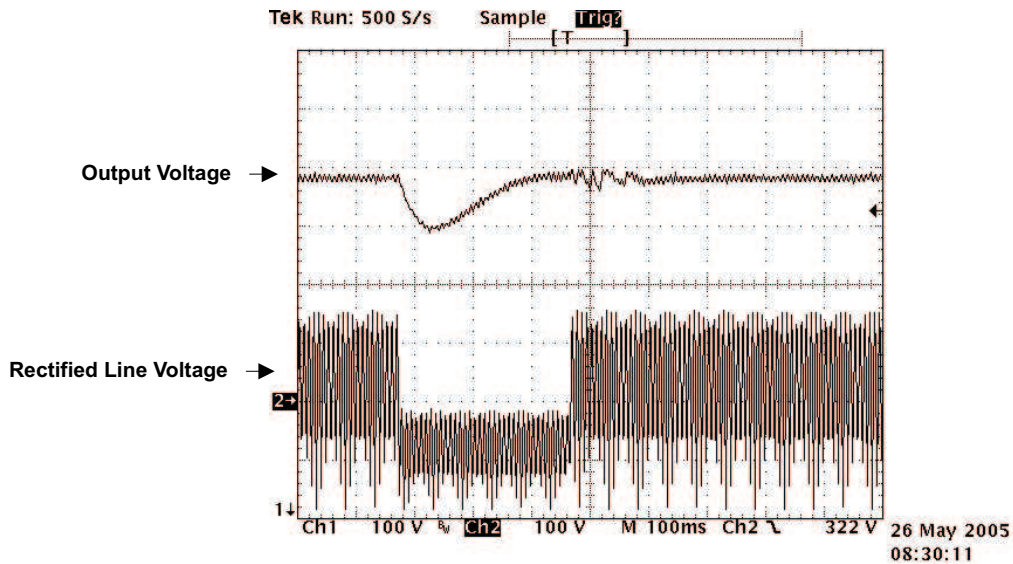

Figure 16. Line Transient, $P_{OUT} = 350\text{ W}$

8.5 2-W Auxiliary Supply (V_{bias})

The unit has a 2-W auxiliary bias supply that was designed to operate with a boost voltage (V_{OUT1}) of 120 V to 400 V. This bias supply is based on a flyback converter and also regulates the PWM/PFC and gate drive circuitry of the evaluation module. Note when V_{BIAS} is not loaded, the gate drive of the flyback is pulse skipping. Once V_{AUX} has been loaded, the gate drive has a fixed duty cycle. Refer to [Figure 17](#), [Figure 18](#), and [Figure 19](#) for details.

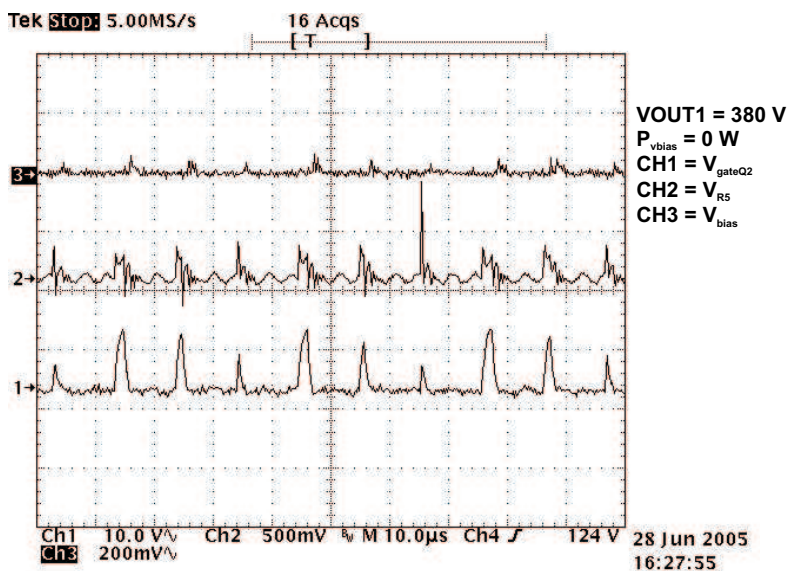

Figure 17. Auxiliary Gate Drive and Current Sense Behavior at No Load

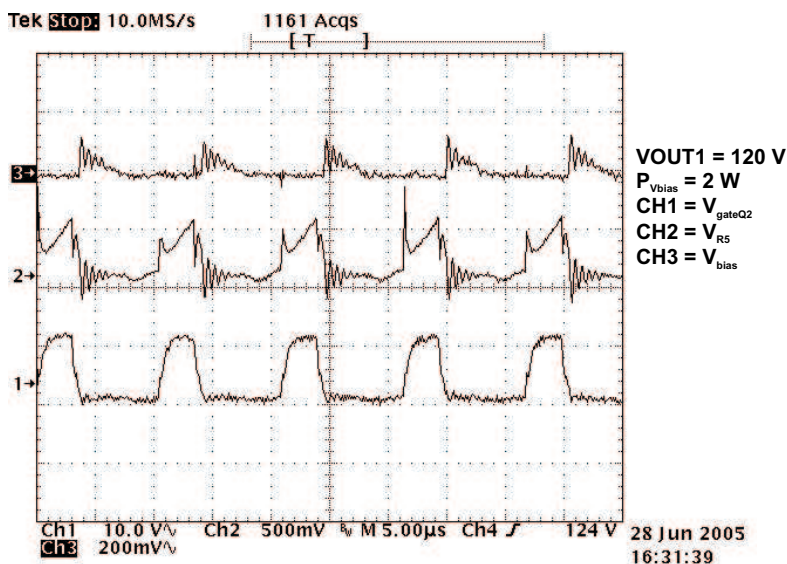

Figure 18. Auxiliary Output with 2-W Load, Gate Drive and Current Sense, $V_{OUT1} = 120$ V

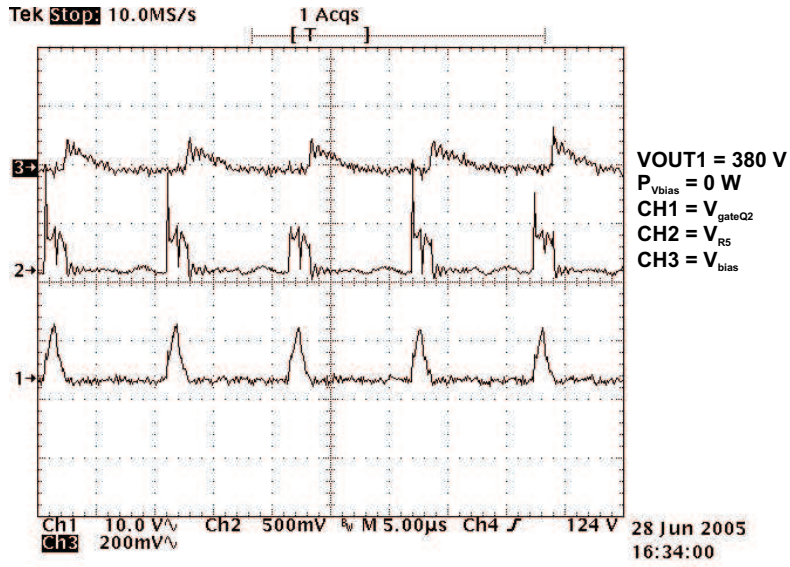

Figure 19. Auxiliary Output with 2-W Load, Gate Drive and Current Sense, VOUT1 = 380 V

9 Reference Design Assembly Drawing

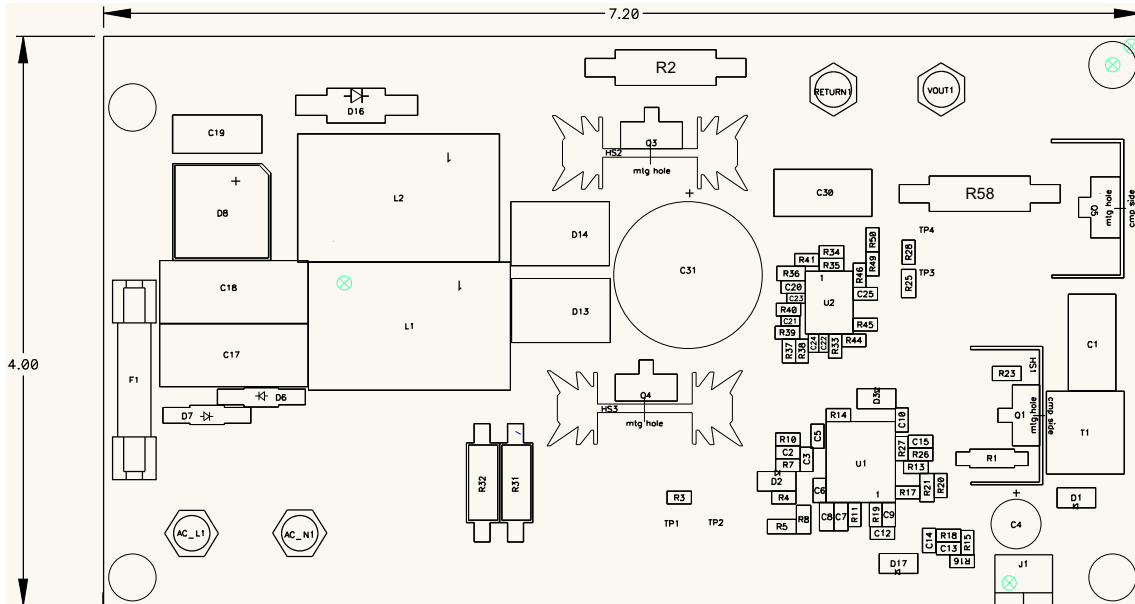
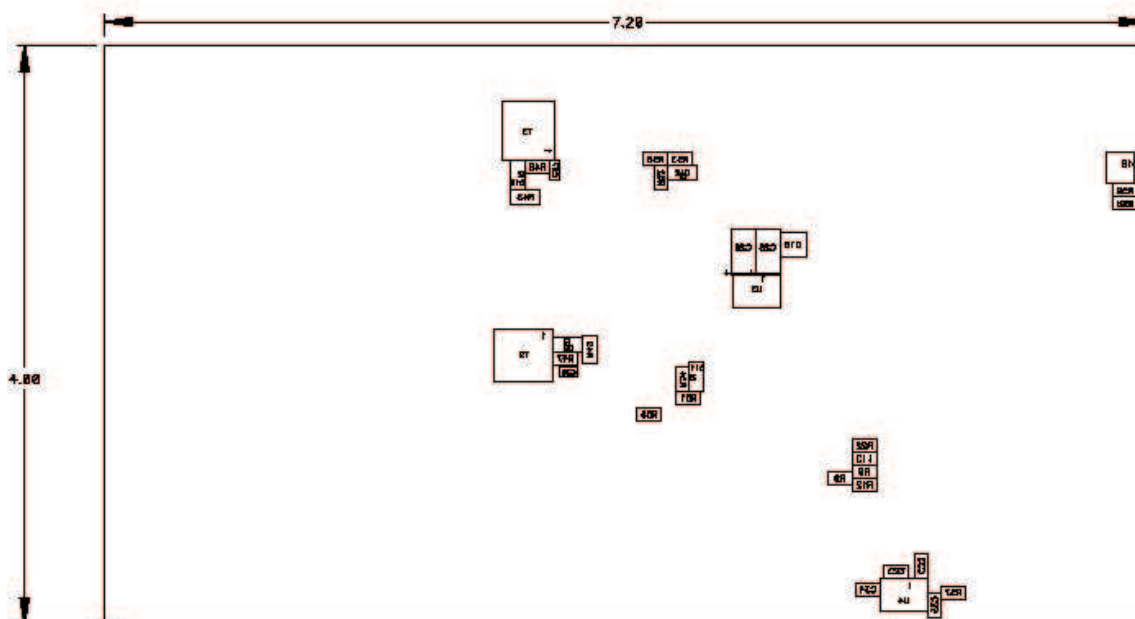

Figure 20. Top Assembly Layer

Figure 21. Bottom Assembly Layer

10 Bill of Materials

Table 2. Parts List

Ref Des	Count	Description	MFR	Part Number
AC_L1, VOUT1	0	Connector, binding post, insulated, for standard banana plug, red, 15 A, 0.425 dia In	Johnson	111-0702-001
AC_N1, RETURN1	0	Connector, binding post, insulated, for standard banana plug, black, 15 A, 0.425 dia In	Johnson	111-0703-001
C1, C33	2	Capacitor, polyester, .047 μ F, 630 V, 10%, 0.256 x 0.650	Panasonic	ECQ-E6473KZ
C10, C17, C18	3	Capacitor, ceramic, 0.1 μ F, 50 V, X7R, 10%, 0805	Panasonic	ECJ-2YB1H104K
C12	1	Capacitor, ceramic, 0.68 μ F, 16 V, X7R, 10%, 0805	std	std
C13	1	Capacitor, ceramic, 270 pF, 50 V, X7R, 10%, 0805	std	std
C14	1	Capacitor, ceramic, 0.47 μ F, 16 V, X7R, 10%, 0805	Panasonic	ECJ-2YB1H104K
C15	1	Capacitor, ceramic, 0.027 μ F, 50 V, X7R, 10%, 0805	std	std
C16, C27	2	Capacitor, ceramic, 180 pF, 50 V, X7R, 10%, 0805	std	std
C19, C23, C28, C35	4	Capacitor, ceramic, 1.0 μ F, 25 V, X7R, 10%, 0805	std	std
C2	1	Capacitor, ceramic, 3.9 nF, 50 V, X7R, 10%, 0805	std	std
C20, C21	2	Capacitor, film, 0.47 μ F, 275 V _{AC} , 0.236 x 0.591	Panasonic	ECQ-U2A474MG
C22	1	Capacitor, film, 0.047 μ F, 300 V _{AC} , 20 \pm %, 0.236 x 0.591	Panasonic	ECQ-U3A473MG
C24, C26	2	Capacitor, ceramic, 56 pF, 50 V, NPO, 5%, 0603	std	std
C25	1	Capacitor, ceramic, 0.47 μ F, 16 V, X7R, 10%, 0603	std	std
C29, C30	2	Capacitor, ceramic, 47 pF, 50 V, X7R, 5%, 0603	std	std
C3	1	Capacitor, ceramic, 68 pF, 50 V, X7R, 10%, 0805	std	std
C31, C32	2	CAP, tantalum chip, 47 μ F, 16 V, 0.281 x 0.126	Vishay	595D476X9016C2T

Table 2. Parts List (continued)

Ref Des	Count	Description	MFR	Part Number
C34	1	Capacitor, 220 μ F, aluminum electrolytic, 450 V _{DC} , -40/+85 °C, \pm 20%, 0.984 In dia.	Panasonic	ECOS2WP221CX
C4	1	Capacitor, 330 μ F, aluminum electrolytic, 25 V, Temp -55°C to 105°C°, \pm 20%, 8 x 11.5 mm	Rubycon	UPW1E331MPD6
C5	1	Capacitor, ceramic, 10 nF, 50 V, X7R, 10%, 0805	std	std
C6, C11	2	Capacitor, ceramic, 100 pF, 50 V, X7R, 10%, 0805	std	std
C7	1	Capacitor, ceramic, 2.2 μ F, 16 V, X7R, 10%, 1206	std	std
C8	1	Capacitor, ceramic, 1 μ F, 25 V, X7R, 10%, 1206	std	std
C9	1	Capacitor, ceramic, 0.22 μ F, 50 V, X7R, 10%, 0805	std	std
D1	1	IC, adjustable precision shunt regulator, SOT-89	Texas Instruments	TL431CPK
D13, D14	2	Diode, schottky rectifier, 10 A, 600 V, TO-263-2	CREE	CSD10060G
D15	1	Diode, zener, 15 V, 350 mW, SOT-23	Diodes, Inc.	BZX84C15
D16	1	Diode, 600 V, 6 A, 400 A peak surge, P600	Diodes, Inc.	6A6-T
D2	1	Diode, rectifier, 1000 mA, 50 V, SMA	Diodes, Inc.	RS1A
D3, D4, D5	3	Diode, schottky, 500 mA, 25 V, SMA	Vishay Telefunken	BYS10-25
D6, D7	2	Diode, signal, 600 V, 1 A , DO-41	On Semiconductor	1N4005RL
D8	1	6 A, 600 V bridge rectifier, GBJ series	General Semiconductor	PB66
D9, D10, D11, D12	4	Diode, schottky, 500 mA, 30 V, SOD123	ON Semiconductor	MBR0530
F1	1	Fuseholder, 1/4 fuses, 0.42	Cooper/Bussman	BK/1A1907-06
Fuse	1	4 A, 250 V, 3AG glass fast acting cartridge type, 1.25 In x .25 In	Littlefuse	312 004
HS1, HS2	2	Heatsink, TO-220, vertical mount, 15°C/W, 0.5 x 0.95	Aavid	593002B03400
HS3, HS4	2	Heatsink, TO-220, vertical mount, 5°C/W, 0.5 x 1.38 In	Aavid	513201
J1	1	Terminal block, 2 pin, 15 A, 5.1 mm, 0.40 x 0.35	OST	ED1609
**L1, L2	2	200 μ H inductor, toroid vertical THT, 100 kHz @ 2 A, 0.866 x 1.358 In	Cooper	CTX16-17309
Q1	1	Transistor, switching power NPN, 1000 V, 5 A, TO-220	On Semi	MJE18004
Q2, Q3 , Q4	3	MOSFET, N-channel, 500 V, 8 A, 750 m Ω , TO-220	International Rectifier	IRF840
R1	1	Resistor, power metal film, 82 k Ω , 3 W, 5 \pm %, 1,000 X 0.200	Panasonic	ERG-3SJ823
R12, R17, R21, R22, R39, R56, R57	7	Resistor, chip, 10 k Ω , 1/10 W, 1%, 0805	std	std
R13	1	Resistor, chip, 5.11 k Ω , 1/10 W, 1%, 0805	std	std
R14	1	Resistor, chip, 30.1 k Ω , 1/10 W, 1%, 0805	std	std
R15	1	Resistor, chip, 3.74 k Ω , 1/10 W, 1%, 0805	std	std
R16	1	Resistor, chip, 2 k Ω , 1/10 W, 1%, 0805	std	std
R18	1	Resistor, chip, 12.1 k Ω , 1/10 W, 1%, 0805	std	std
R19	1	Resistor, chip, 20 k Ω , 1/10 W, 1%, 0805	std	std
R2	1	Resistor, chip, 110 k Ω , 1/10 W, 1%, 0805	std	std
R20	1	Resistor, chip, 316 k Ω , 1/10 W, 1%, 0805	std	std
R23	1	Resistor, chip, 34 k Ω , 1/10 W, 1%, 0805	std	std
R24	1	Resistor, chip, 22.1 k Ω , 1/10 W, 1%, 0805	std	std
R25, R28	2	Resistor, chip, 562 k Ω , 1/8 W, 1%, 0805	std	std
R26	1	Resistor, chip, 15 k Ω , 1/10 W, 01%, 0805	std	std

Table 2. Parts List (continued)

Ref Des	Count	Description	MFR	Part Number
R27	1	Resistor, chip, 100 Ω , 1/8 W, 0.1%, 1206	std	std
R29, R40, R41	3	Resistor, chip, 1 k Ω , 1/10 W, 1%, 0805	std	std
R3	1	Resistor, chip, 28.0 k Ω , 1/10 W, 1%, 0805	std	std
R30	1	Resistor, chip, 9.09 k Ω , 1/10 W, 1%, 0805	Panasonic	ERJ-6ENF9091V
R32, R33	2	Resistor current sense 0.20 Ω 3 W, 0.600 x 0.250 In	Ohmite	13FR200
R34	1	Resistor, chip, 59 k Ω , 1/10 W, 5%, 0805	std	std
R35	1	Resistor, chip, 13.3 k Ω , 1/10 W, 1%, 0805	std	std
R36	1	Resistor, chip, 38.3 k Ω , 1/10 W, 1%, 0805	std	std
R37	1	Resistor, chip, 20.0 Ω , 1/4 W, 1%, 1206	std	std
R38	1	Resistor, chip, 6.81 k Ω , 1/10 W, 1%, 0805	std	std
R4	1	Resistor, power metal film, 500V 10 k Ω , 3 W, 5 \pm %, 1,000 X 0.200	Panasonic	ERG-3SJ103
R42	1	Resistor, chip, 2.94 k Ω , 1/8 W, 1%, 805	std	std
R43, R44	2	Resistor, chip, 6.04 k Ω , 1/10 W, 1%, 1206	std	std
R45	1	Resistor, chip, 20.5 k Ω , 1/10 W, 1%, 0805	std	std
R46	1	Resistor, chip, 80.6 k Ω , 1/10 W, 1%, 0805	std	std
R47, R50, R51	3	Resistor, chip, 324 k Ω , 1/10 W, 1%, 0805	std	std
R48, R49	2	Resistor, chip, 100 Ω , 1/10 W, 1%, 0805	std	std
R5	1	Resistor, carbon film, 4.3 Ω 1/4 W, 5%, Axial, RN55	YAGEO	CFR-25JB-4R3
R52, R54	2	Resistor, chip, 0 Ω , 1/10 W, 5%, 0805	std	std
R53, R55	2	Resistor, chip, 5.23 Ω , 1/10 W, 1%, 0805	std	std
R6, R31	2	Resistor, chip, 47 Ω , 1/10 W, 1%, 0805	std	std
R7, R10	2	Resistor, chip, 2.32 k Ω , 1/10 W, 1%, 0805	std	std
R8, R11	2	Resistor, chip, 390 k Ω , 1/8 W, 1%, 1206	std	std
R9	1	Resistor, chip, 1.5 k Ω , 1/10 W, 1%, 0805	std	std
**T1	1	Inductor, dual-coupled, 9:1, 0.559 x 0.508 In	Cooper	CTX16-17169
**T2, T3	2	Transformer, current sense, 10 A, 500 kHz, 1:50, 0.330 x 0.360	Pulse	PA1005.050
TP1, TP2, TP3, TP4	4	Jack, test point, circle	Farnell	240-3xx
**U1	1	IC, Bi CMOS PFC\PWM Controller, SOP20 (DW)	TI	UCC28528DW
**U2	1	IC, Precision op-amp, SO8	TI	OP07DD
**U3	1	IC, Dual interleaved PWM controller with programmable max duty cycle, SO16	TI	UCC28220D
**U4	1	IC, High speed low side power MOSFET driver, SO8	TI	UCC27324D
X1 @ HS1, HS2, HS3, HS4	4	Thermal pad silicon, TO-220 size	BERQUIST	3223-07FR-51
X1 @ HS1, HS2, HS3, HS4	4	Nut #4-40 (steel)		
X1 @ HS1, HS2, HS3, HS4	4	Split lock washer #4(steel)		
X1 @ HS1, HS2, HS3, HS4	4	Flat washer #4 (steel)		
X1 @ HS1, HS2, HS3, HS4	4	Nylon shoulder washer #4	Keystone Electronics	3049

Table 2. Parts List (continued)

Ref Des	Count	Description	MFR	Part Number
X1 @ HS1, HS2, HS3, HS4	4	Pan head screw #4-40 X 3/8 (steel)		
Standoff	4	Pan head screw #6 X 32 1/4 nylon, used with standoffs		
Standoff	4	Standoff 6/32 thrd 3/8 x 3/8 In	Daburn Electronics	10-42
--	1	PCB, 0 In x 0 In x 0 In	Any	HPA117A

FCC Warnings

This equipment is intended for use in a laboratory test environment only. It generates, uses, and can radiate radio frequency energy and has not been tested for compliance with the limits of computing devices pursuant to subpart J of part 15 of FCC rules, which are designed to provide reasonable protection against radio frequency interference. Operation of this equipment in other environments may cause interference with radio communications, in which case the user at his own expense will be required to take whatever measures may be required to correct this interference.

EVM WARNINGS AND RESTRICTIONS

It is important to operate this EVM within the input voltage range of 85 V to 125 V RMS and the output voltage range of 374 V to 425 V.

Exceeding the specified input range may cause unexpected operation and/or irreversible damage to the EVM. If there are questions concerning the input range, please contact a TI field representative prior to connecting the input power.

Applying loads outside of the specified output range may result in unintended operation and/or possible permanent damage to the EVM. Please consult the EVM User's Guide prior to connecting any load to the EVM output. If there is uncertainty as to the load specification, please contact a TI field representative.

During normal operation, some circuit components may have case temperatures greater than 50°C. The EVM is designed to operate properly with certain components above 50°C as long as the input and output ranges are maintained. These components include but are not limited to linear regulators, switching transistors, pass transistors, and current sense resistors. These types of devices can be identified using the EVM schematic located in the EVM User's Guide. When placing measurement probes near these devices during operation, please be aware that these devices may be very warm to the touch.

Mailing Address: Texas Instruments, Post Office Box 655303, Dallas, Texas 75265
Copyright © 2005, Texas Instruments Incorporated

IMPORTANT NOTICE

Texas Instruments Incorporated and its subsidiaries (TI) reserve the right to make corrections, modifications, enhancements, improvements, and other changes to its products and services at any time and to discontinue any product or service without notice. Customers should obtain the latest relevant information before placing orders and should verify that such information is current and complete. All products are sold subject to TI's terms and conditions of sale supplied at the time of order acknowledgment.

TI warrants performance of its hardware products to the specifications applicable at the time of sale in accordance with TI's standard warranty. Testing and other quality control techniques are used to the extent TI deems necessary to support this warranty. Except where mandated by government requirements, testing of all parameters of each product is not necessarily performed.

TI assumes no liability for applications assistance or customer product design. Customers are responsible for their products and applications using TI components. To minimize the risks associated with customer products and applications, customers should provide adequate design and operating safeguards.

TI does not warrant or represent that any license, either express or implied, is granted under any TI patent right, copyright, mask work right, or other TI intellectual property right relating to any combination, machine, or process in which TI products or services are used. Information published by TI regarding third-party products or services does not constitute a license from TI to use such products or services or a warranty or endorsement thereof. Use of such information may require a license from a third party under the patents or other intellectual property of the third party, or a license from TI under the patents or other intellectual property of TI.

Reproduction of information in TI data books or data sheets is permissible only if reproduction is without alteration and is accompanied by all associated warranties, conditions, limitations, and notices. Reproduction of this information with alteration is an unfair and deceptive business practice. TI is not responsible or liable for such altered documentation.

Resale of TI products or services with statements different from or beyond the parameters stated by TI for that product or service voids all express and any implied warranties for the associated TI product or service and is an unfair and deceptive business practice. TI is not responsible or liable for any such statements.

Following are URLs where you can obtain information on other Texas Instruments products and application solutions:

Products		Applications	
Amplifiers	amplifier.ti.com	Audio	www.ti.com/audio
Data Converters	dataconverter.ti.com	Automotive	www.ti.com/automotive
DSP	dsp.ti.com	Broadband	www.ti.com/broadband
Interface	interface.ti.com	Digital Control	www.ti.com/digitalcontrol
Logic	logic.ti.com	Military	www.ti.com/military
Power Mgmt	power.ti.com	Optical Networking	www.ti.com/opticalnetwork
Microcontrollers	microcontroller.ti.com	Security	www.ti.com/security
		Telephony	www.ti.com/telephony
		Video & Imaging	www.ti.com/video
		Wireless	www.ti.com/wireless

Mailing Address: Texas Instruments
Post Office Box 655303 Dallas, Texas 75265