

# D6F-PH

MEMS Differential Pressure Sensor

## A Compact, High-Accuracy Differential Pressure Sensor with Superior Resistance to Environments.

 Air  Digital



- High accuracy of  $\pm 3\%$  RD
- Linearized and temperature compensated
- Digital output (I2C communication)
- High flow impedance to reduce the influence of bypass configuration

RoHS Compliant



Refer to the *Common Precautions for the D6F Series* on page 39.

## Ordering Information

| Applicable fluid (See note 1.) | Differential pressure range (See note 3.) | Flow Port Type | Connection     | Model                 |
|--------------------------------|---|----------------|----------------|-----------------------|
| Air (See note 2.)              | 0 to 250 Pa                               | Bamboo joint   | Lead terminals | <b>D6F-PH0025AD1</b>  |
|                                |   |                | Connector      | <b>D6F-PH0025AD2</b>  |
|                                |   | Manifold       | Connector      | <b>D6F-PH0025AMD2</b> |
|                                | $\pm 50$ Pa                               | Bamboo joint   | Lead terminals | <b>D6F-PH0505AD3</b>  |
|                                |   |                | Connector      | <b>D6F-PH0505AD4</b>  |
|                                |   | Manifold       | Connector      | <b>D6F-PH0505AMD4</b> |
|                                | $\pm 500$ Pa                              | Bamboo joint   | Lead terminals | <b>D6F-PH5050AD3</b>  |
|                                |   |                | Connector      | <b>D6F-PH5050AD4</b>  |
|                                |   | Manifold       | Connector      | <b>D6F-PH5050AMD4</b> |

Note. Models with different slave addresses are also available. Consult your OMRON representative for details.

Note: 1. The Sensor be calibrated for different gas types. Consult your Omron representative.

Note: 2. Dry gas must not contain large particles, e.g., dust, oil, or mist.

Note: 3. At standard atmospheric pressure (1013.25 hPa)

### ● Accessory (Sold separately)

| Type  | Model             |
|-------|-------------------|
| Cable | <b>D6F-CABLE3</b> |

Note. This cable is for connection with the D6F-PH0025AD2, D6F-PH0025AMD2, D6F-PH0505AD4, D6F-PH0505AMD4, D6F-PH5050AD4, and D6F-PH5050AMD4 connector-type models. One side is a connector and the other side is a lead wire.

Note. Refer to *Accessories for the D6F Series* on page 38.

### ● Evaluation Board (Sold separately)

The D6F-PH MEMS differential pressure sensor can be connected to the OMRON sensor evaluation board.

The following three platforms are supported, and evaluation can easily be performed by connecting the differential pressure sensor, evaluation board, and harness to the platform.

| Platform                                      | Evaluation board      | Sample code   | Connection harness (between the evaluation board and D6F-PH) | Compatible differential pressure sensor D6F-PH                       |
|---|-----------------------|---|--|--|
| For connecting to Raspberry Pi (See note 1.)  | <b>2JCIE-EV01-RP1</b> | <a href="https://github.com/omron-devhub/d6f-2jcieev01-raspberrypi">https://github.com/omron-devhub/d6f-2jcieev01-raspberrypi</a> | 2JCIE-HARNESS-02 (See note 4.)                               | <b>D6F-PH0025AD1</b><br><b>D6F-PH0505AD3</b><br><b>D6F-PH5050AD3</b> |
| For connecting to Arduino (See note 2.)       | <b>2JCIE-EV01-AR1</b> | <a href="https://github.com/omron-devhub/d6f-2jcieev01-arduino">https://github.com/omron-devhub/d6f-2jcieev01-arduino</a>         |  | 2JCIE-HARNESS-03 (See note 5.)                                       |
| For connecting to ESP32 Feather (See note 3.) | <b>2JCIE-EV01-FT1</b> | <a href="https://github.com/omron-devhub/d6f-2jcieev01-arduino">https://github.com/omron-devhub/d6f-2jcieev01-arduino</a>         |  |  |

For more information about the evaluation board, please visit the following URL.

(<https://components.omron.com/sensor/evaluation-board/2jcie>)

For information on how to use the sample code, please refer to the D6F-PH User's Manual.

Note: 1. Raspberry Pi is a registered trademark of the Raspberry Pi Foundation.

Note: 2. Arduino is a registered trademark of Arduino LLC and Arduino SRL.

Note: 3. Feather is a registered trademark of Adafruit Industries LLC.

Note: 4. The 2JCIE-HARNESS-02 is a connector on one side and a lead wire on the other. The lead wire must be connected to the D6F-PH for use.

Note: 5. The 2JCIE-HARNESS-03 has connectors on both sides. Both the D6F-PH and the evaluation board can be easily connected using these connectors.

## Output Characteristics

**D6F-PH0025AD1**  
**D6F-PH0025AD2**  
**D6F-PH0025AMD2**

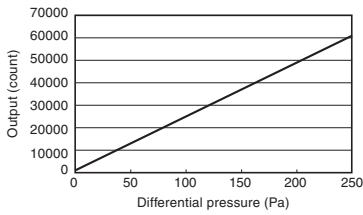

| Differential pressure (Pa) | 0           | 50           | 100          | 150          | 200          | 250          |
|----------------------------|-------------|--------------|--------------|--------------|--------------|--------------|
| Output (HEX)               | 1024 (0400) | 13024 (32E0) | 25024 (61C0) | 37024 (90A0) | 49024 (BF80) | 61024 (EE60) |

Measurement conditions: Power supply voltage of  $3.3 \pm 0.1$  VDC, ambient temperature of  $25 \pm 5^\circ\text{C}$ , and ambient humidity of 35% to 75%.  
 Differential pressure conversion formula:  $Dp = (Op - 1024) / 60000 \times 250$   
 Dp = Differential pressure, Op = Output

**D6F-PH5050AD3**  
**D6F-PH5050AD4**  
**D6F-PH5050AMD4**

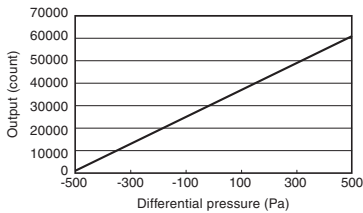

| Differential pressure (Pa) | -500        | -300         | -100         | 0            | 100          | 300          | 500          |
|----------------------------|-------------|--------------|--------------|--------------|--------------|--------------|--------------|
| Output (HEX)               | 1024 (0400) | 13024 (32E0) | 25024 (61C0) | 31024 (7930) | 37024 (90A0) | 49024 (BF80) | 61024 (EE60) |

Measurement conditions: Power supply voltage of  $3.3 \pm 0.1$  VDC, ambient temperature of  $25 \pm 5^\circ\text{C}$ , and ambient humidity of 35% to 75%.  
 Differential pressure conversion formula:  $Dp = (Op - 1024) / 60000 \times 1000 - 500$   
 Dp = Differential pressure, Op = Output

**D6F-PH0505AD3**  
**D6F-PH0505AD4**  
**D6F-PH0505AMD4**

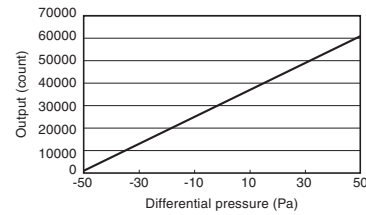

| Differential pressure (Pa) | -50         | -30          | -10          | 0            | 10           | 30           | 50           |
|----------------------------|-------------|--------------|--------------|--------------|--------------|--------------|--------------|
| Output (HEX)               | 1024 (0400) | 13024 (32E0) | 25024 (61C0) | 31024 (7930) | 37024 (90A0) | 49024 (BF80) | 61024 (EE60) |

Measurement conditions: Power supply voltage of  $3.3 \pm 0.1$  VDC, ambient temperature of  $25 \pm 5^\circ\text{C}$ , and ambient humidity of 35% to 75%.  
 Differential pressure conversion formula:  $Dp = (Op - 1024) / 60000 \times 100 - 50$   
 Dp = Differential pressure, Op = Output

Note. Change of gas density affects the sensor output.  
 Change of atmospheric pressure is compensated by the following formula.  
 $Dpeff = Dp \times (Pstd / Pamb)$   
 Dpeff: Effective differential pressure  
 Dp: Differential pressure of the sensor output  
 Pstd: Standard atmospheric pressure (1013.25 hPa)  
 Pamb: Actual ambient atmospheric pressure (hPa)

## Characteristics/Performance

| Model                                    | D6F-PH0025AD1  | D6F-PH0025AD2      | D6F-PH0025AMD2     | D6F-PH0505AD3  | D6F-PH0505AD4      | D6F-PH0505AMD4     | D6F-PH5050AD3  | D6F-PH5050AD4      | D6F-PH5050AMD4     |
|--|--|--------------------|--------------------|--|--------------------|--------------------|--|--------------------|--------------------|
| Differential pressure range (See note 1) | 0 to 250 Pa  |                    |                    | ±50 Pa   |                    |                    | ±500 Pa  |                    |                    |
| Calibration Gas (See note 2.)            | Air  |                    |                    |  |                    |                    |  |                    |                    |
| Port Type                                | Bamboo joint<br>Maximum outside diameter: 4.9 mm, minimum outside diameter: 4.0 mm                           |                    | Manifold           | Bamboo joint<br>Maximum outside diameter: 4.9 mm, minimum outside diameter: 4.0 mm |                    | Manifold           | Bamboo joint<br>Maximum outside diameter: 4.9 mm, minimum outside diameter: 4.0 mm |                    | Manifold           |
| Electrical Connection                    | Lead terminals   | Four-pin connector | Four-pin connector | Lead terminals   | Four-pin connector | Four-pin connector | Lead terminals   | Four-pin connector | Four-pin connector |
| Power Supply                             | 2.3 to 3.6 VDC   |                    |                    |  |                    |                    |  |                    |                    |
| Current Consumption                      | 6 mA max. with no load and Vcc of 3.3 VDC, GND = 0 VDC, 25°C   |                    |                    |  |                    |                    |  |                    |                    |
| Resolution                               | 12 bit   |                    |                    |  |                    |                    |  |                    |                    |
| Zero point tolerance (See note 3.)       | ±0.2 Pa  |                    |                    |  |                    |                    |  |                    |                    |
| Span tolerance (See note 3.)             | ±3% RD   |                    |                    |  |                    |                    |  |                    |                    |
| Span shift due to temperature variation  | < 0.5% RD per 10°C   |                    |                    |  |                    |                    |  |                    |                    |
| Response time                            | 33 ms typical at 12 bit resolution (50 ms max.)<br>The processing time is 6 ms typical at 12 bit resolution. |                    |                    |  |                    |                    |  |                    |                    |
| Gas flow through sensor (See note 5.)    | 63 mL/min  |                    |                    | 23 mL/min  |                    |                    | 100 mL/min   |                    |                    |
| Interface                                | I2C  |                    |                    |  |                    |                    |  |                    |                    |
| Case material                            | PPS  |                    |                    |  |                    |                    |  |                    |                    |
| Degree of Protection                     | IEC IP40 (Excluding tubing sections.)  |                    |                    |  |                    |                    |  |                    |                    |
| Withstand Pressure                       | 10 kPa   |                    |                    |  |                    |                    |  |                    |                    |
| Operating temperature (See note 4.)      | -20 to +80°C   |                    |                    |  |                    |                    |  |                    |                    |
| Operating humidity (See note 4.)         | 35 to 85 %RH   |                    |                    |  |                    |                    |  |                    |                    |
| Storage temperature (See note 4.)        | -40 to +80°C   |                    |                    |  |                    |                    |  |                    |                    |
| Storage humidity (See note 4.)           | 35 to 85 %RH   |                    |                    |  |                    |                    |  |                    |                    |
| Insulation Resistance                    | Between sensor outer cover and lead terminals: 20 MΩ min. (at 500 VDC)                                       |                    |                    |  |                    |                    |  |                    |                    |
| Dielectric Strength                      | Between sensor outer cover and lead terminals: 500 VAC, 50/60 Hz min. for 1 min (leakage current: 1 mA max.) |                    |                    |  |                    |                    |  |                    |                    |
| Weight                                   | 5.0 g  | 5.0 g              | 5.4 g              | 5.0 g  | 5.0 g              | 5.4 g              | 5.0 g  | 5.0 g              | 5.4 g              |

Note: 1. At standard atmospheric pressure (1013.25 hPa)

Note: 2. Dry gas must not contain large particles, e.g., dust, oil, or mist.

Note: 3. The zero point tolerance and span tolerance are independent uncertainties and add according to the principles of error propagation.

Note: 4. With no condensation or icing.

Note: 5. Type D6F-PH is based on thermal flow principle. Air flow is needed to measure the differential pressure.

Typical characteristic of air flow by differential pressure is below.

### Relation between pressure and flow rate

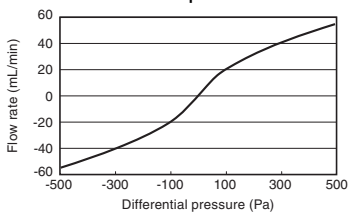

## Tubing (Example for Bamboo Joint)

You can use the bypass method to connect and measure the differential pressure.

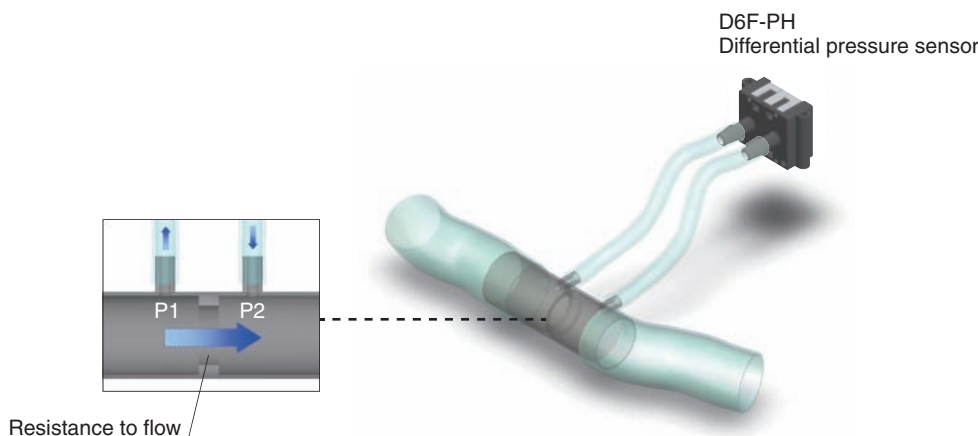

## Connections/Dimensions

CAD Data Please visit our CAD Data website, which is noted on the last page.

(Unit: mm)

### ● Lead Terminals

D6F-PH0025AD1  
D6F-PH0505AD3  
D6F-PH5050AD3

CAD Data

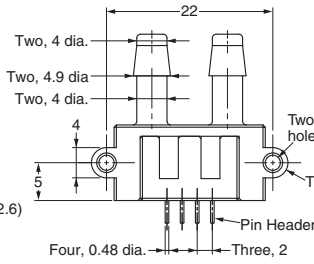
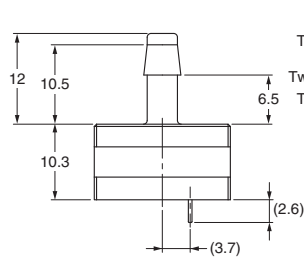
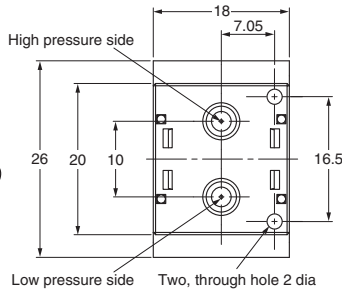
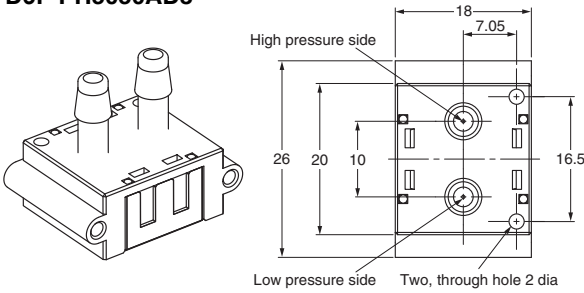

### Recommendation size for pin header installation (tolerances: $\pm 0.1$ )

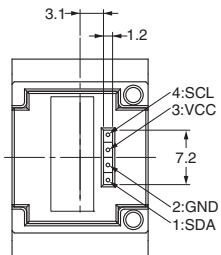
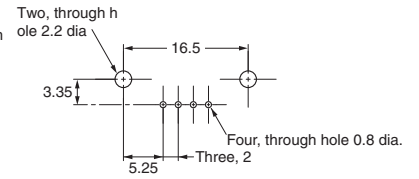

### Tubes

Install tubes made of materials such as rubber, urethane or nylon so that they will not come out. For urethane tubes, tubes with an outer diameter of 6 mm and an inner diameter of 4 mm are recommended.

### Soldering Conditions

Use a soldering iron for 5 s at 350°C with a pressure of 100 gf max.

# D6F-PH

# MEMS Differential Pressure Sensor

## ● Connectors

**D6F-PH0025AD2**  
**D6F-PH0505AD4**  
**D6F-PH5050AD4**

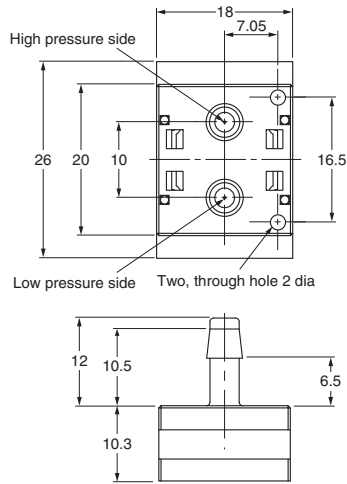
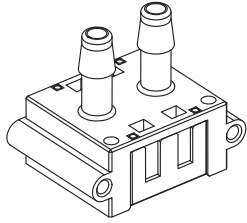

Note. Use M1.8 panhead screws or tapping screws for installation, and tighten the screws to a maximum torque of 0.36 N·m. Use the following connectors to connect to the Sensor.  
 Connector : GHR-04V-S (made by J.S.T. Mfg. Co.)  
 Terminals : SSSL-002T-P0.2 (made by J.S.T. Mfg. Co.)  
 Wires AWG26 to AWG30

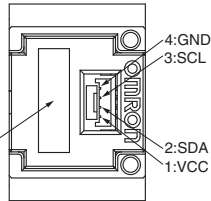
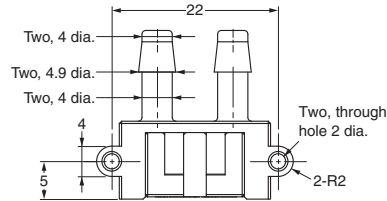

Label: Gives model and lot numbers.

CAD Data

**D6F-PH0025AMD2**  
**D6F-PH0505AMD4**  
**D6F-PH5050AMD4**

Note: 1. Use M3 screws (round head screws) or tapping screws as the installation screws, and tighten the screws to a maximum torque of 1.0 N·m.  
 Note: 2. The outer diameter of screw heads and washers must be 6 mm or less.  
 Note: 3. The sealing part of the inlet port must have a 7.0-dia. ditch and P4 O-ring. (Compliant with JIS B 2401)  
 Note: 4. Use the following connectors to connect to the Sensor.  
 Connector : GHR-04V-S (made by J.S.T. Mfg. Co.)  
 Terminals : SSSL-002T-P0.2 (made by J.S.T. Mfg. Co.)  
 Wires AWG26 to AWG30

### Recommended Installation Dimensions

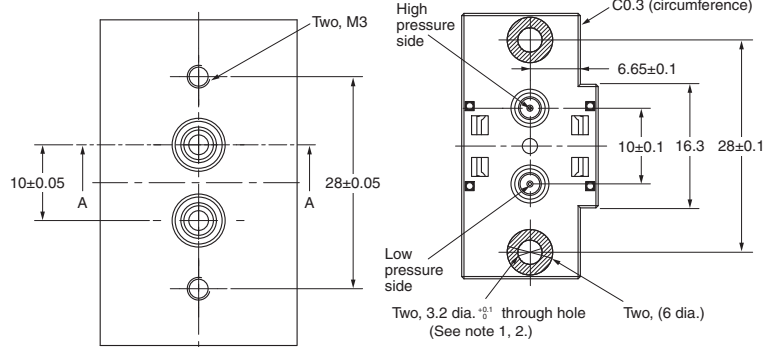
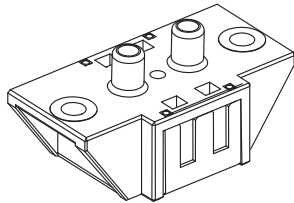

### A-A inlet port Recommended dimensions of O-ring sealing surface (See note.3)

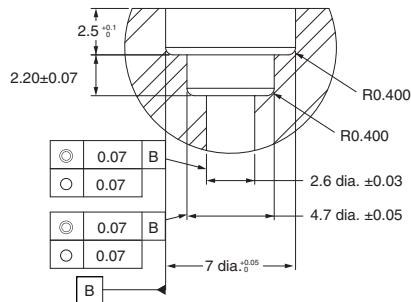

Label: Gives model and lot numbers.

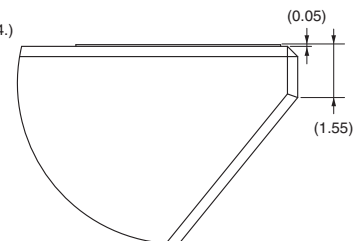
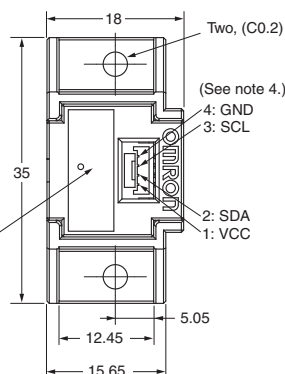
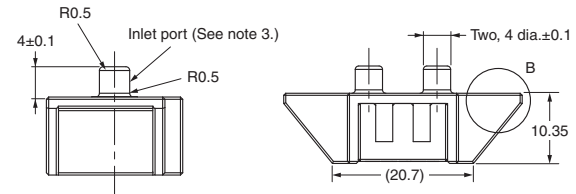

Detailed View of B  
 Scale 10:1

CAD Data

## Electrical connection

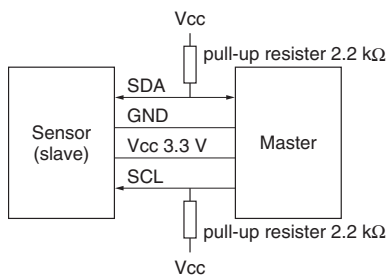

## Communication

|                  |            |                         |
|------------------|------------|-------------------------|
| Serial Interface |            | I2C                     |
| Slave address    | HEX        | 0x6C                    |
|                  | BIN (7bit) | 0b110_1100              |
| Speed mode       |            | Max. 400kHz (Fast Mode) |
| Signal           | SCL        | Serial Clock            |
|                  | SDA        | Data Signal             |

# Accessories for the D6F Series

## Dimensions

**CAD Data** Please visit our CAD Data website, which is noted on the last page.

(Unit: mm)

### ● Cable (Sold separately)

#### D6F-CABLE1

**CAD Data**

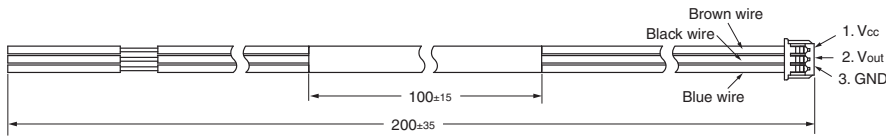

Connector :51021 (Manufactured by Molex, LLC)  
Terminal :50079 (Manufactured by Molex, LLC)  
Wire :.014SQ

#### D6F-CABLE2

**CAD Data**

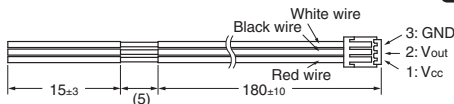

Contact :SSH-003T-P0.2 (Manufactured by J.S.T. Mfg. Co., Ltd.)  
Housing :SHR-03V-S (Manufactured by J.S.T. Mfg. Co., Ltd.)  
Wire :AWG#30

#### D6F-CABLE2-L

**CAD Data**

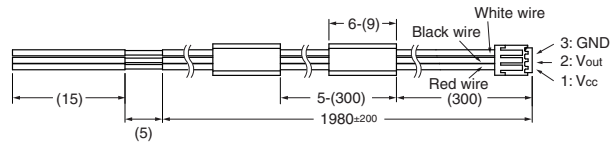

Contact :SSH-003T-P0.2 (Manufactured by J.S.T. Mfg. Co., Ltd.)  
Housing :SHR-03V-S (Manufactured by J.S.T. Mfg. Co., Ltd.)  
Wire :AWG#30

#### D6F-CABLE3

**CAD Data**

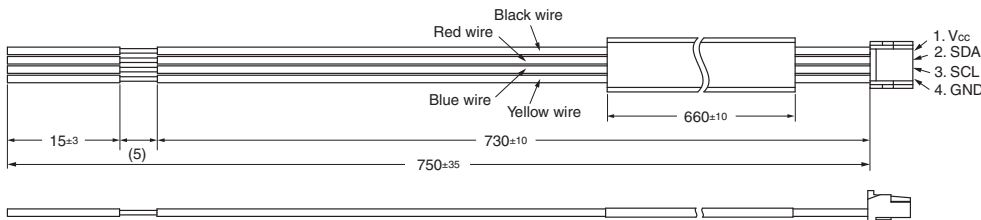

Contact :SSHL-002T-P0.2 (Manufactured by J.S.T. Mfg. Co., Ltd.)  
Housing :GHR-04V-S (Manufactured by J.S.T. Mfg. Co., Ltd.)  
Wire :AWG#28

#### D6F-W CABLE

**CAD Data**



Contact :SZH-002T-P0.5 (Manufactured by J.S.T. Mfg. Co., Ltd.)  
Housing :ZHR-3 (Manufactured by J.S.T. Mfg. Co., Ltd.)  
Wire :AWG#26

#### D6F-W CABLE-L

**CAD Data**

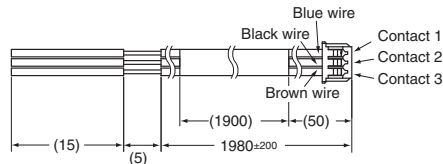

Contact :SZH-002T-P0.5 (Manufactured by J.S.T. Mfg. Co., Ltd.)  
Housing :ZHR-3 (Manufactured by J.S.T. Mfg. Co., Ltd.)  
Wire :AWG#26

### ● Quick fastener (Sold separately)

#### D6F-FASTENER-P10 (for P10)

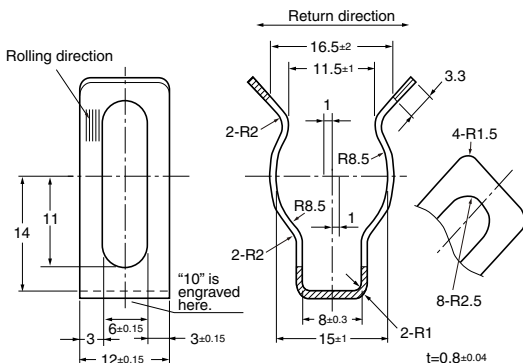

**CAD Data**

### ● Pipe fittings (Sold separately)

#### D6F-PLG1 (for P10)

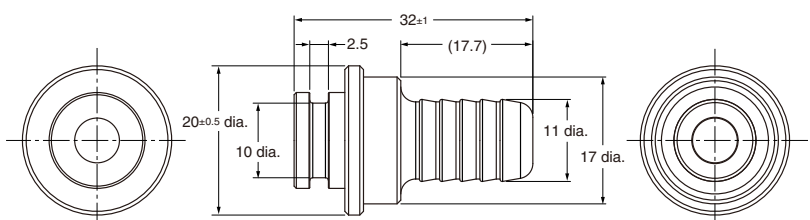

**CAD Data**

# Common Precautions for the D6F Series

## Safety Precautions

### Precautions for Correct Use

#### ● Sensor Applications

The D6F is built for use with general-purpose devices. In particular, when using the D6F for applications with the safety requirements described below, take steps to ensure system and device safety through measures such as fail-safe designs, redundant designs, and regular inspections.

- Safety devices for ensuring safety for persons
- Transportation equipment control (such as applications to stop operation)
- Aviation and space equipment
- Nuclear power equipment

Do not use the D6F for applications in which D6F operation would directly affect human life.

#### ● Fluids, Pipe Mounting and Sensor Installation

##### All D6F Models

- (1) Use clean fluids. Install a filter or mist separator on the inflow pipe. Failure to do so may result in malfunction or changes in characteristics due to dust or mist. This does not apply to the D6F-W, D6F-V, D6F-P and D6F-PH.
- (2) Do not use corrosive gases other than the specified applicable fluids (such as chlorine, sulfur, acid, or alkali). Doing so may cause product failure.
- (3) The specified performance may not be obtained if the D6F is used for fluids other than the specified applicable fluids.
- (4) After removing the Sensor from the package, do not allow foreign particles to enter the piping. Foreign particles in the piping may cause product failure.
- (5) Install the sensor so that the fluid flows in the direction indicated by the arrow on the Sensor. Correct measurements cannot be obtained if the fluid flows in the wrong direction. This does not apply to the D6F-V, D6F-P and D6F-PH.
- (6) It is recommended that the Sensor (except for the D6F-A3) be mounted horizontally. If it is not mounted horizontally, an error of  $\pm 1\%$  FS or higher may result.
- (7) Install the Sensor on a flat surface. Incorrect installation may damage the Sensor and make it impossible to obtain correct measurements.
- (8) Make sure that the power to all equipment is turned OFF before you install the Sensor. Installing the Sensor while the power supply is ON may result in electrical shock or abnormal operation.
- (9) Always check operation after installation.
- (10) Do not drop the Sensor or disassemble the cover.

##### D6F-A1

- (1) Make sure that pipes with bamboo joints are airtight. Correct measurements cannot be obtained if there is leakage from joints.
- (2) Use M3 panhead screws to install the Sensor, and tighten them to a maximum torque of 0.59 N•m.

##### D6F-N2/-L2

- (1) Use the Rc 1/4 tapped threads for the pipes, and tighten the threads to a maximum torque of 5 N•m. Tightening beyond this value may result in fractures, which can cause leaks. Apply a suitable amount of pipe sealer. Do not apply sealer on the first two threads from the end of the threaded section. When you tighten the pipes, do not allow foreign matter or oil on the joint area.
- (2) Use M3 panhead screws to install the Sensor, and tighten them to a maximum torque of 0.59 N•m.

##### D6F-A3

- (1) When installing the pipes, use M5 screws for the joints and tighten to a torque of 1.5 N•m maximum. Use sealing tape to make the joints airtight. Incorrect installation may make it impossible to obtain correct measurements.
- (2) It is recommended that the Sensor be mounted either horizontally or vertically. Mounting the Sensor at an angle may make it impossible to obtain correct measurements.
- (3) Use M3 panhead screws to install the Sensor, and tighten them to a maximum torque of 0.59 N•m.

##### D6F-A5

- (1) Use M3 panhead screws to install the Sensor, and tighten them to a maximum torque of 0.59 N•m.
- (2) Install O-rings to seal the fluid inlet and outlet points. The recommended O-ring is JIS B 2401, nominal number P5.

##### Installation Example

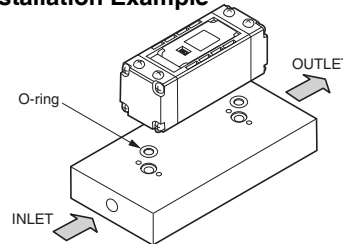

##### D6F-A6

- (1) Use the appropriate threads (R1/4, NPT1/8 or NPT1/2) for the pipes, and tighten the pipes to a maximum torque of 5 N•m. Tightening beyond this value may result in fractures, which can cause leaks. When you tighten the pipes, do not allow foreign matter or oil on the joint area. Use a spanner or adjustable wrench to turn the connecting section (aluminum alloy) and connect the pipe. Do not place the spanner or wrench on the Sensor (PPS). Doing so may damage the Sensor or result in leaks. Apply a suitable amount of pipe sealer. Do not apply sealer on the first two threads from the end of the threaded section. When you tighten the pipes, do not allow foreign matter or oil on the joint area.
- (2) Use M3 panhead screws to install the Sensor, and tighten them to a maximum torque of 0.59 N•m.



# Common Precautions for the D6F Series

## D6F-A7/-L7/-N7/-A7D/-AB71/-AB71D

- (1) Use male quick couplings for the piping, and secure them with the applicable quick fasteners.
- (2) Do not apply excessive force to the adapter section when connecting the pipes. If strong force is applied to the connected pipes, or if strong force is applied directly to the adapter section while holding the Sensor, it may damage the Sensor or cause leakage.

### Installation Example

Use male, P10-type quick-connect joints for the D6F-A7/-L7/-N7/-A7D and P14-type quick-connect joints for the D6F-AB71/-AB71D.

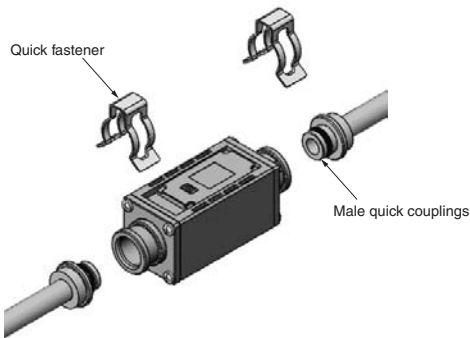

### Applicable male quick coupling dimensions (Unit: mm)

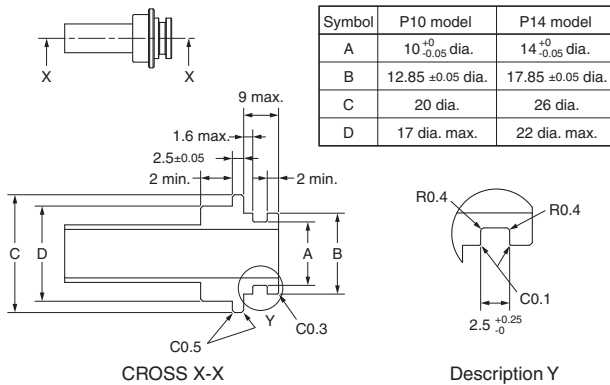

Note. There is a possibility that leak damage or faulty of the body occurs when static load of more than 40 N is applied to 300 mm from the center of product as fulcrum point.

## D6F-P0001A1/-P0010A1/-P0010A2

- (1) Depending on the ambient environment and installation location, dust, dirt, and other foreign matter may come in inside the Sensor and block a part or all of the flow path or accumulate on internal components. This may result in the Sensor not being able to perform to the specifications given above. Always perform a pre-evaluation on your actual equipment and be aware of the possible problems that may occur before you use the Sensor with the actual equipment.
- (2) Attach all tubes so that the fluid flows only in the direction from the positive side (+) to the negative side (-). Refer to the figure on page 26 for the installation direction.
- (3) For PCB-mounting Sensors, perform terminal soldering only after the Sensor is secured into place on the PCB. Use a soldering iron for 5 s at 350°C with a pressure of 100 gf max. (This applies only to PCB-mounting Sensors.)
- (4) Use M2.6 panhead screws or equivalent tapping screws to mount the Sensor, and tighten the screws to a maximum torque of 0.59 N•m.

## D6F-P0010AM2

- (1) Depending on the ambient environment and installation location, dust, dirt, and other foreign matter may come in inside the Sensor and block a part or all of the flow path or accumulate on internal components. This may result in the Sensor not being able to perform to the specifications given above. Always perform a pre-evaluation on your actual equipment and be aware of the possible problems that may occur before you use the Sensor with the actual equipment.
- (2) Attach all tubes so that the fluid flows only in the direction from the positive side (+) to the negative side (-). Install the Sensor with the manifold facing downward. Refer to the figure on page 26 for the installation direction.
- (3) Use M3 panhead screws or equivalent tapping screws to mount the Sensor, and tighten the screws to a maximum torque of 0.59 N•m.
- (4) Install O-rings to seal the fluid inlet and outlet points. The recommended O-ring is JIS B 2401, nominal number P4.

### Installation Example

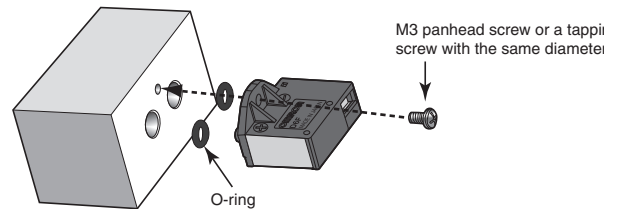

## D6F-PHAD1/-PHAD2/-PHAD3/-PHAD4

- (1) Depending on the ambient environment and installation location, dust, dirt, and other foreign matter may come in inside the Sensor and block a part or all of the flow path or accumulate on internal components. This may result in the Sensor not being able to perform to the specifications given above. Always perform a pre-evaluation on your actual equipment and be aware of the possible problems that may occur before you use the Sensor with the actual equipment.
- (2) Attach all tubes so that the fluid flows only in the direction from the high pressure side (+) to the low pressure side (-).
- (3) Use M1.8 panhead screws or equivalent tapping screws to mount the Sensor, and tighten the screws to a maximum torque of 0.36 N•m.
- (4) The sensor output is affected with the length of a tube. The error is less than 1% with a tube (ID:4mm) length up to 800mm.
- (5) Connection (D6F-PHAD1/-PHAD3)
  - Wire with the correct terminal names and polarities. Incorrect wiring will cause failure of internal components.
  - Do not use flow soldering.
  - Please solder after fixed on the circuit board by screw.
  - Use a soldering iron:
    - Soldering condition Pressure Max.100gf
    - Temperature 350 degree C
    - Time Max. 5s

# Common Precautions for the D6F Series

## D6F-PHAMD2/-PHAMD4

- (1) Depending on the ambient environment and installation location, dust, dirt, and other foreign matter may come in inside the Sensor and block a part or all of the flow path or accumulate on internal components. This may result in the Sensor not being able to perform to the specifications given above. Always perform a pre-evaluation on your actual equipment and be aware of the possible problems that may occur before you use the Sensor with the actual equipment.
- (2) Attach all tubes so that the fluid flows only in the direction from the high pressure side (+) to the low pressure side (-).
- (3) Use M3 screws (round head screws) to install the Sensor, and tighten them to a maximum torque of 1.0 N•m. The outer diameter of screw heads and washers must be 6 mm or less. Check that the Sensor is securely fastened by the screws.
- (4) Seal the sealing part of the inlet port with an O-ring. The recommended O-ring is JIS B 2401, nominal number P4.

## D6F-W

- (1) Depending on the ambient environment and installation location, dust, dirt, and other foreign matter may come in inside the Sensor and block a part or all of the flow path or accumulate on internal components. This may result in the Sensor not being able to perform to the specifications given above. Always perform a pre-evaluation on your actual equipment and be aware of the possible problems that may occur before you use the Sensor with the actual equipment.
- (2) Use M3 panhead screws to install the Sensor, and tighten them to a maximum torque of 0.59 N•m.

## D6F-V

- (1) Depending on the ambient environment and installation location, dust, dirt, and other foreign matter may come in inside the Sensor and block a part or all of the flow path or accumulate on internal components. This may result in the Sensor not being able to perform to the specifications given above. Always perform a pre-evaluation on your actual equipment and be aware of the possible problems that may occur before you use the Sensor with the actual equipment.
- (2) Use M3 panhead screws to install the Sensor, and tighten them to a maximum torque of 0.59 N•m.
- (3) This Sensor does not contain any protective circuits. Never allow the electrical load to exceed the maximum ratings. Doing so may damage the circuits. Install protective circuits if required.
- (4) Mount the Sensor so that the flow inlet side (the side with the logo) is perpendicular to the windward side and ensure that the flow inlet and flow outlet are not blocked in any way. If the Sensor is not mounted correctly, accurate measurements cannot be made.

### Installation Example

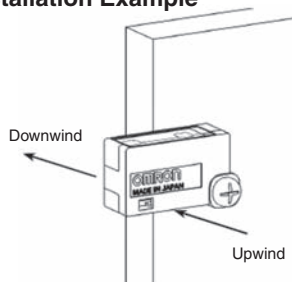

## ● Operating Environment

Do not use the Sensor in the following locations:

- Locations directly subject to heat radiated from heating equipment
- Locations subject to water or oil
- Locations subject to direct sunlight
- Locations subject to intense temperature changes
- Locations subject to icing or condensation
- Locations subject to excessive vibration or shock

## ● Countermeasures against Noise

Noise may make it impossible to obtain correct measurements. Consider the following countermeasures.

- Allow as much space as possible between the Sensor and devices that generates high frequencies (such as high-frequency welders and high-frequency sewing machines) or surges.
- Attach surge absorbers or noise filters to noise-generating devices that are near the Sensor (in particular, equipment with inductance, such as motors, transformers, solenoids, and magnetic coils).  
(It also helps to separate pipes and ducts, and to use shielded cables.)

## ● Power Supply

- Force of connector terminal is 20 N max. Do not add strength more than tension of wire bending to connector at wiring. Install the connector coaxially to the fitting axis with holding all wires. And pulling angle should be within 15 degrees.
- Use the applicable connectors. Directly soldering the connection terminals will cause product failure. (except for the D6F-PH)
- Check the terminal names and polarity and wire the power supply correctly. Incorrect wiring will cause failure of internal components.
- When using a commercially available switching regulator, ground the FG (frame ground) and G (ground) terminals.

## ● Handling

The sensor is a precision device, and if large shock and load is applied, it may cause a failure or characteristic change. Do not drop it, disassemble it, or apply force to the terminals more than necessary. And please do not use dropped product.

- The sensor shall only be handled in electrostatic discharge protected areas (EPA) under protected and controlled conditions

## RoHS Directive

The RoHS mark is displayed on the packing of products for which the six substances banned by the RoHS Directive have been abolished (both in processing and in the electronic components mounted to the PCBs).

\* RoHS marking may be terminated if it is later determined that parts that were previously treated as RoHS compliant are not compliant due to circumstances at the supplier of the parts.

## ● RoHS Compliance Criteria

The following standards are used to determine RoHS compliance for the six banned substances.

(Items to which the RoHS Directive is not applicable are not given.)

- Lead: 1,000 ppm max.
- Hexavalent chromium: 1,000 ppm max.
- Mercury: 1,000 ppm max.
- PBB: 1,000 ppm max.
- Cadmium: 100 ppm max.
- PBDE: 1,000 ppm max.

For correct way of use, please check respective User's Manuals below.

- 1) MEMS Flow Sensor D6F Series User's Manual (Manual No. A286-E1)
- 2) MEMS Flow Sensor D6F-A7D/-AB71D User's Manual (Manual No. A302-E1)
- 3) MEMS Flow Sensor D6F-P User's Manual (Manual No. A299-E1)
- 4) MEMS Flow Sensor D6F-W/D6F-V User's Manual (Manual No. A300-E1)
- 5) MEMS Flow Sensor D6F-PH User's Manual (Manual No. A288-E1)

Please check each region's Terms & Conditions by region website.

---

## OMRON Corporation

Electronic and Mechanical Components Company

### Regional Contact

#### Americas

<https://www.components.omron.com/>

#### Asia-Pacific

<https://ecb.omron.com.sg/>

#### Korea

<https://www.omron-ecb.co.kr/>

#### Europe

<http://components.omron.eu/>

#### China

<https://www.ecb.omron.com.cn/>

#### Japan

<https://www.omron.co.jp/ecb/>