

# VPL10-5000

### Electrical Specifications (@25C)

1. Maximum Power: 50.0VA
2. Input Voltage – **Series:** 230VAC @ 50/60Hz, **Parallel:** 115VAC @ 50/60Hz
3. Output Voltage – **Series:** 10.0V CT @ 5.0A, **Parallel:** 5.0V @ 10.0A
4. Voltage Regulation: 20% TYP @ full load to no load
5. Hipot: 3500VAC between primary to secondary and windings to core.

### Construction:

Dual winding construction with an insulated shroud, both made of a high temperature material that exceeds UL flammability requirements. Shrouds are provided over the connections of the leads to the windings on both primary and secondary coils. Devices are designed with a minimum of 6mm creepage distance between the primary and secondary and are manufactured with a Class B (130°C) insulation system.

### Agency Files:

TUV: File R72182067, EN 61558-1:2005+A1, EN61558-2-6:2009. Double Insulated. Non-inherently Short-Circuit-Proof.



Dimensions: Units: In inches

A	B	C	D	E	F
2.562	4.00	2.250	3.562	8.00	0.187

Weight: 2.3 lbs.

### Connections<sup>1</sup>:

**Input:** Series – BLK to BLU, Jumper WHT to BRN  
Parallel – BLK to BLU, Jumper BLK to BRN and WHT to BLU

**Output:** Series – RED to GRY, Jumper YEL to VIO  
Parallel – RED to GRY, Jumper RED to VIO and YEL to GRY

**RoHS Compliance:** As of manufacturing date February 2016, all standard products meet the requirements of 2015/863/EU, known as the RoHS 3 initiative.

\* Upon printing, this document is considered "uncontrolled". Please contact Triad Magnetics' website for the most current version.

<sup>1</sup> Primary and secondary windings are designed to be connected in series or parallel. Windings are not intended to be used independently.

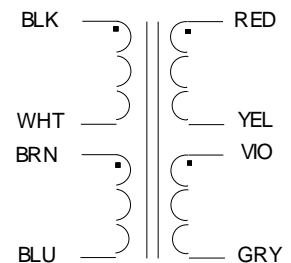
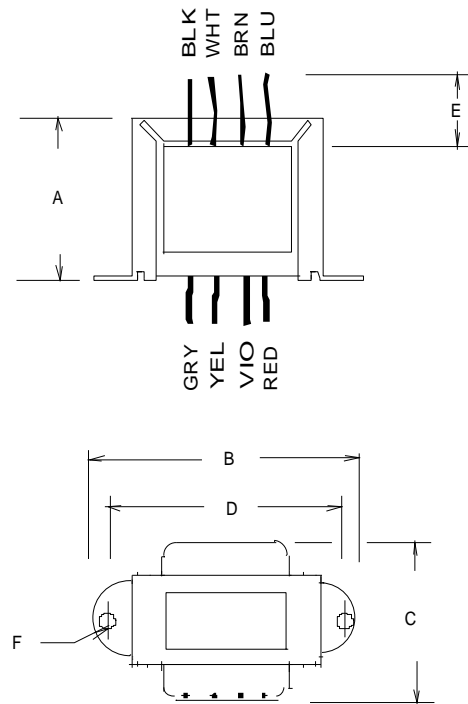
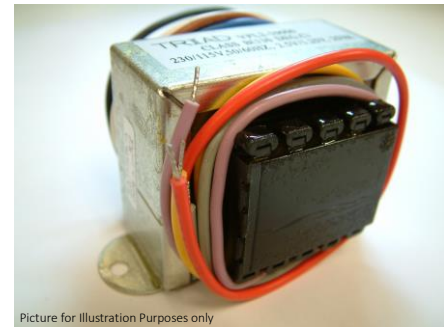

**SCHEMATIC**