

SPECIFICATION

Part No.	:	G30.B.108111.wm
Product Name	:	Olympian Direct Mount Ultra Wide-Band LTE / Cellular / CDMA Antenna For 4G/3G/2G Applications
Features	:	LTE / GSM / CDMA / DCS / PCS / WCDMA / UMTS / HSDPA / GPRS / EDGE / IMT 698 to 960MHz and 1710 to 2700MHz Heavy duty screw mount UV and vandal resistant ABS housing and thread. L-Shaped bracket IP67 compliant Standard is 1M RG-316 SMA(M) Cables and Connectors Customizable RoHS Compliant



1. Introduction

This G30.wm, wall mounted G30 Olympian antenna is a high performance screw mount wide-band cellular antenna with stainless steel L-bracket to allow it to be mounted on a wall or panel. Omni-directional high gain and high efficiency across all bands ensures constant reception and transmission. This is vital for today's high data bandwidth applications in video and mobile broadband.

Durable UV resistant ABS housing is resistant to vandalism and direct attack. At only 48mm in height it is small enough to mount unobtrusively in most locations. This antenna is mounted on metal and plastic structures and is locked from the inside of the structure by a nut. Adhesive foam at the base provides a watertight seal to the mounting structure. High quality waterproof and corrosion resistant Teflon jacket RG316 is used for the cable.

Two of these G30 separated at distance from each other are ideal for the latest LTE MIMO spatial diversity applications.

Customized cable length and connectors are available. Taoglas recommend a minimum cable length of 70mm when used on a ground plane to achieve an efficiency of greater than 40% in the 900MHz band and greater than 60% in the 1800MHz band. For longer cable lengths and if 700MHz band is required, it is necessary to use the MA740 Pantheon for 4G/3G/2G or the MA741 4G/3G/2G MIMO Pantheon.

2. Specification

ELECTRICAL			
STANDARD	4G/3G/2G		
Operation Frequency(MHz)	698~960MHz	1710~2170MHz	2500~2800MHz
Peak Gain(dB)			
On 30*30cm metal with 1 meter cable length	1.2	3.2	2.5
On L-shaped bracket with 1 meter cable length	0.77	2.32	-0.01
On L-shaped bracket with 3 meter cable length	-1.08	-1.23	-2.71
On L-shaped bracket with 5 meter cable length	-3.04	-4.06	-6.82
Average Gain(dB)			
On 30*30cm metal with 1 meter cable length	-4.5	-2.5	-4.5
On L-shaped bracket with 1 meter cable length	-3.29	-2.95	-4.58
On L-shaped bracket with 3 meter cable length	-5.26	-5.88	-8.30
On L-shaped bracket with 5 meter cable length	-7.35	-8.17	-11.16
Efficiency (%)			
On 30*30cm metal with 1 meter cable length	40	55	40
On L-shaped bracket with 1 meter cable length	47.40	51.32	34.96
On L-shaped bracket with 3 meter cable length	31.27	26.04	14.91
On L-shaped bracket with 5 meter cable length	18.82	15.35	7.67
VSWR	< 3		
Impedance	< 50ohm		
Polarization	Linear		
Radiation Pattern	Omni-directional		
Max Input Power	5 W		

MECHANICAL	
Dimensions (mm)	Height=48mm and Diameter=50mm
Cable	RG316
Casing	UV Resistant ABS
Base and Thread	Nickel plated Copper
Connector	SMA(M) Fully Customizable
Nut	Nut M12
Sealant	Rubber Stopper
Weight	66g
Recommended Torque	2.94N·m
Max Torque	3.92N·m
ENVIRONMENTAL	
Protection	IP67 Waterproof
Corrosion	5% NACI for 96hrs- Nickel plated steel base and thread
Temperature Range	-40°C to +85°C
Thermal Shock	100 cycles -40°C to +85°C
Humidity	Non-condensing 65 C 95% RH
Shock (Drop Test)	1m drop on concrete 6 axes
Cable Pull	8Kgf (* 1 meters)

LTE BANDS			
Band Number	LTE / LTE-Advanced / WCDMA / HSPA / HSPA+ / TD-SCDMA		
	Uplink	Downlink	Covered
1	UL: 1920 to 1980	DL: 2110 to 2170	✓
2	UL: 1850 to 1910	DL: 1930 to 1990	✓
3	UL: 1710 to 1785	DL: 1805 to 1880	✓
4	UL: 1710 to 1755	DL: 2110 to 2155	✓
5	UL: 824 to 849	DL: 869 to 894	✓
7	UL: 2500 to 2570	DL: 2620 to 2690	✓
8	UL: 880 to 915	DL: 925 to 960	✗
9	UL: 1749.9 to 1784.9	DL: 1844.9 to 1879.9	✓
11	UL: 1427.9 to 1447.9	DL: 1475.9 to 1495.9	✗
12	UL: 699 to 716	DL: 729 to 746	✓
13	UL: 777 to 787	DL: 746 to 756	✓
14	UL: 788 to 798	DL: 758 to 768	✓
17	UL: 704 to 716	DL: 734 to 746 (LTE only)	✓
18	UL: 815 to 830	DL: 860 to 875 (LTE only)	✓
19	UL: 830 to 845	DL: 875 to 890	✓
20	UL: 832 to 862	DL: 791 to 821	✓
21	UL: 1447.9 to 1462.9	DL: 1495.9 to 1510.9	✗
22	UL: 3410 to 3490	DL: 3510 to 3590	✗
23	UL: 2000 to 2020	DL: 2180 to 2200 (LTE only)	✓
24	UL: 1625.5 to 1660.5	DL: 1525 to 1559 (LTE only)	✗
25	UL: 1850 to 1915	DL: 1930 to 1995	✓
26	UL: 814 to 849	DL: 859 to 894	✓
27	UL: 807 to 824	DL: 852 to 869 (LTE only)	✓
28	UL: 703 to 748	DL: 758 to 803 (LTE only)	✓
29	UL: -	DL: 717 to 728 (LTE only)	✓
30	UL: 2305 to 2315	DL: 2350 to 2360 (LTE only)	✓
31	UL: 452.5 to 457.5	DL: 462.5 to 467.5 (LTE only)	✗
32	UL: -	DL: 1452 - 1496	✗
35		1850 to 1910	✓
38		2570 to 2620	✓
39		1880 to 1920	✓
40		2300 to 2400	✓
41		2496 to 2690	✓
42		3400 to 3600	✗
43		3600 to 3800	✗

*Covered bands represent an efficiency greater than 20%

3. Antenna Characteristics

3.1. Testing setup

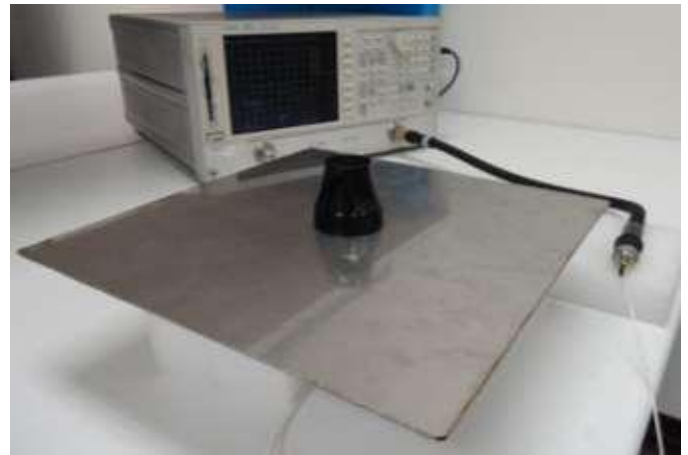
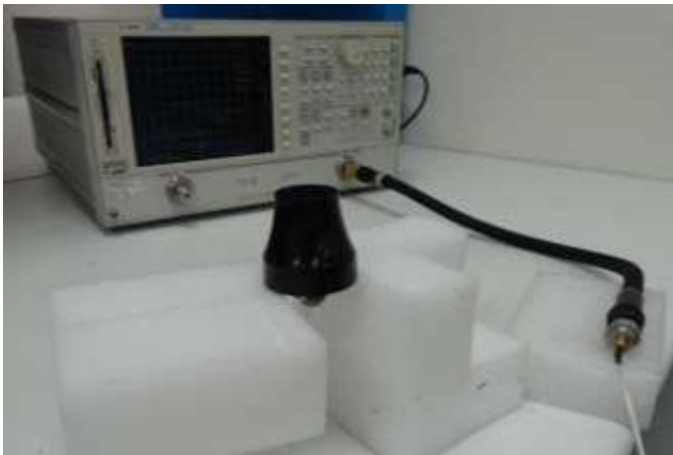

Figure1. Measurement Setup of G30 Antenna in Free Space, 30cmx30cm metal plate and L-shaped frame.

3.2. Return Loss

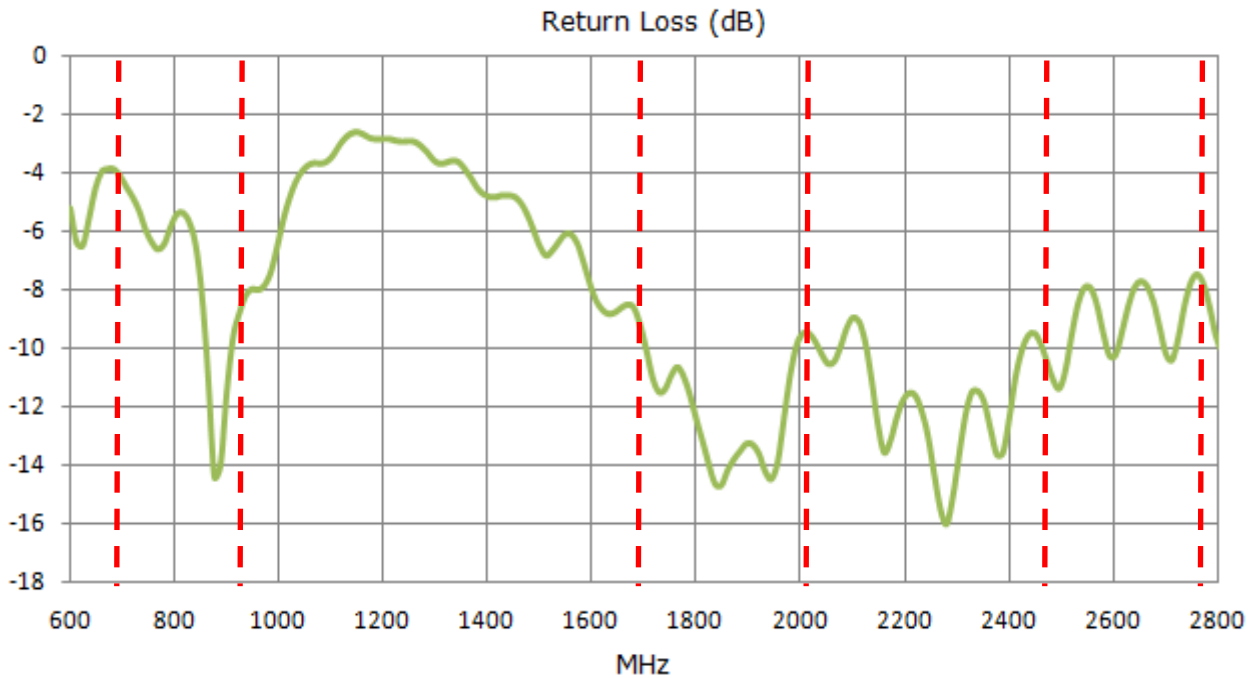

Figure2. In Free Space with 1 meters cable length

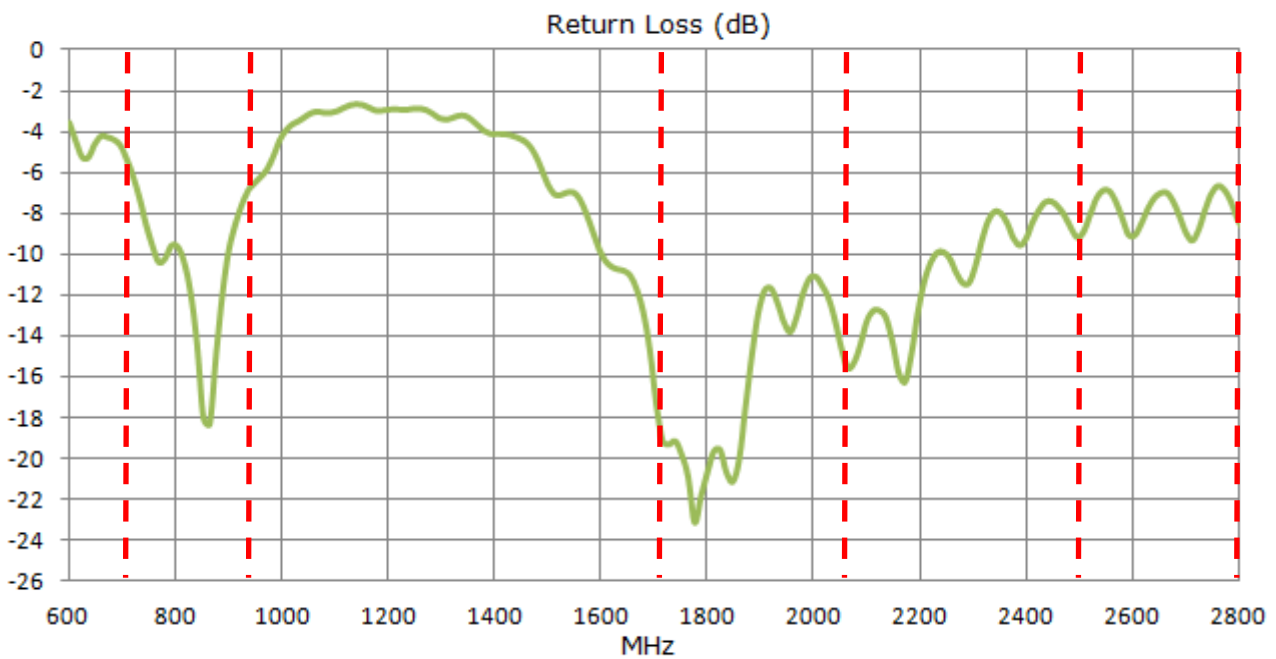

Figure3. On 30x30cm metal with 1 meters cable length

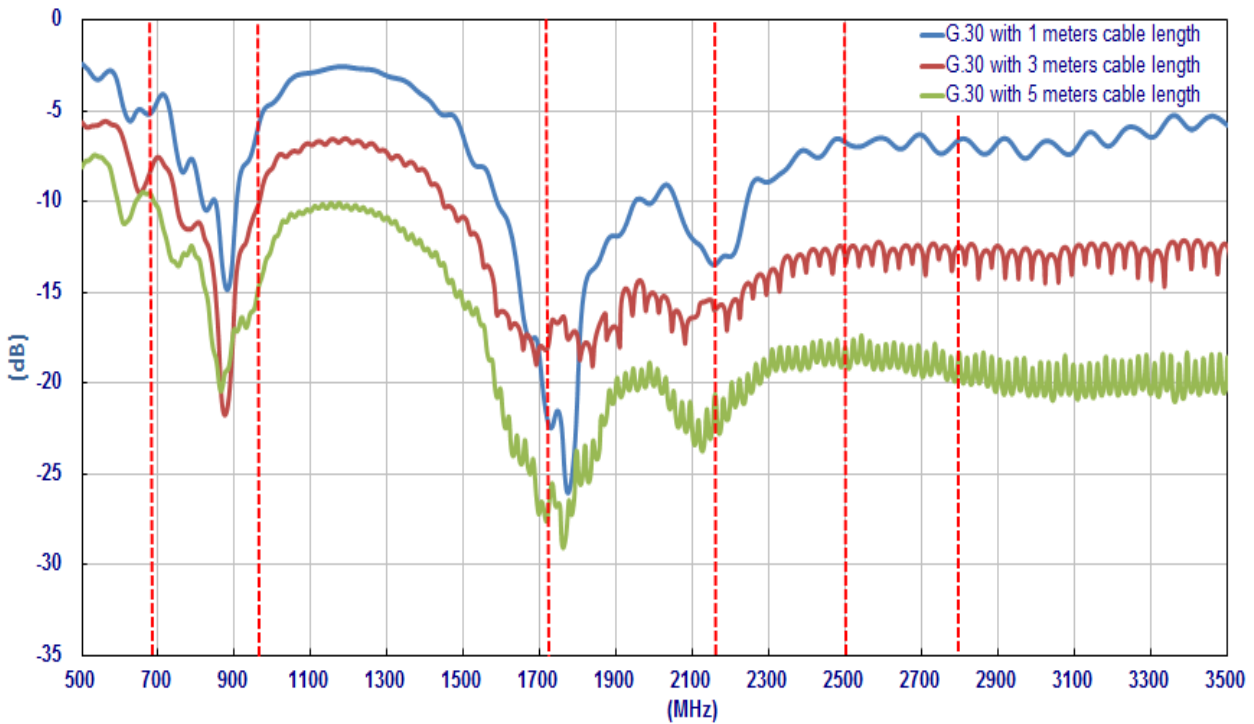

Figure4. On L-shaped bracket

3.3. Peak Gain

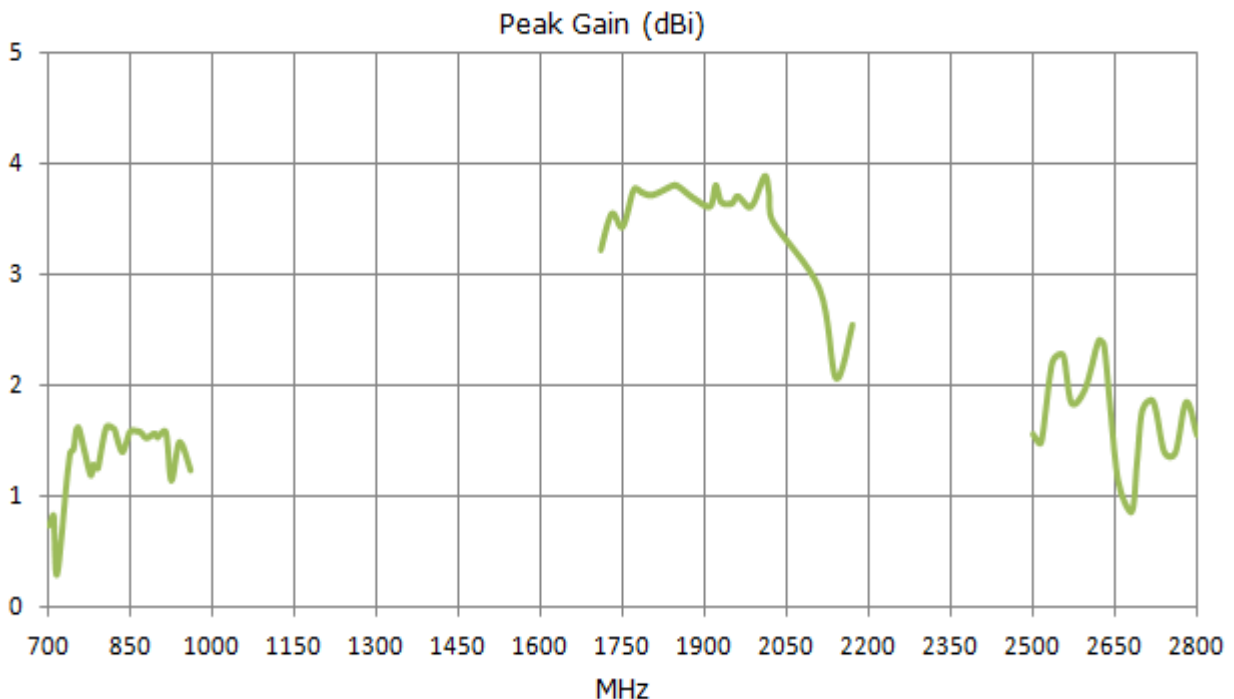

Figure5. In Free Space with 1 meters cable length

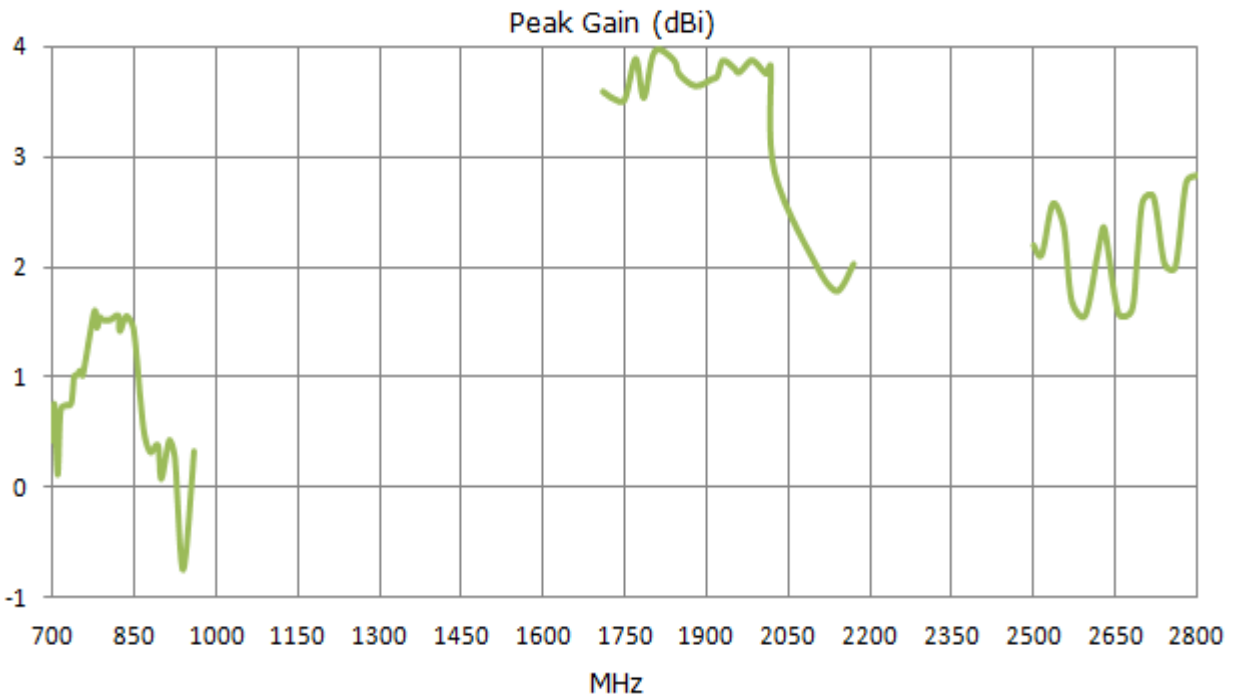

Figure6. On 30x30cm metal with 1 meter cable length

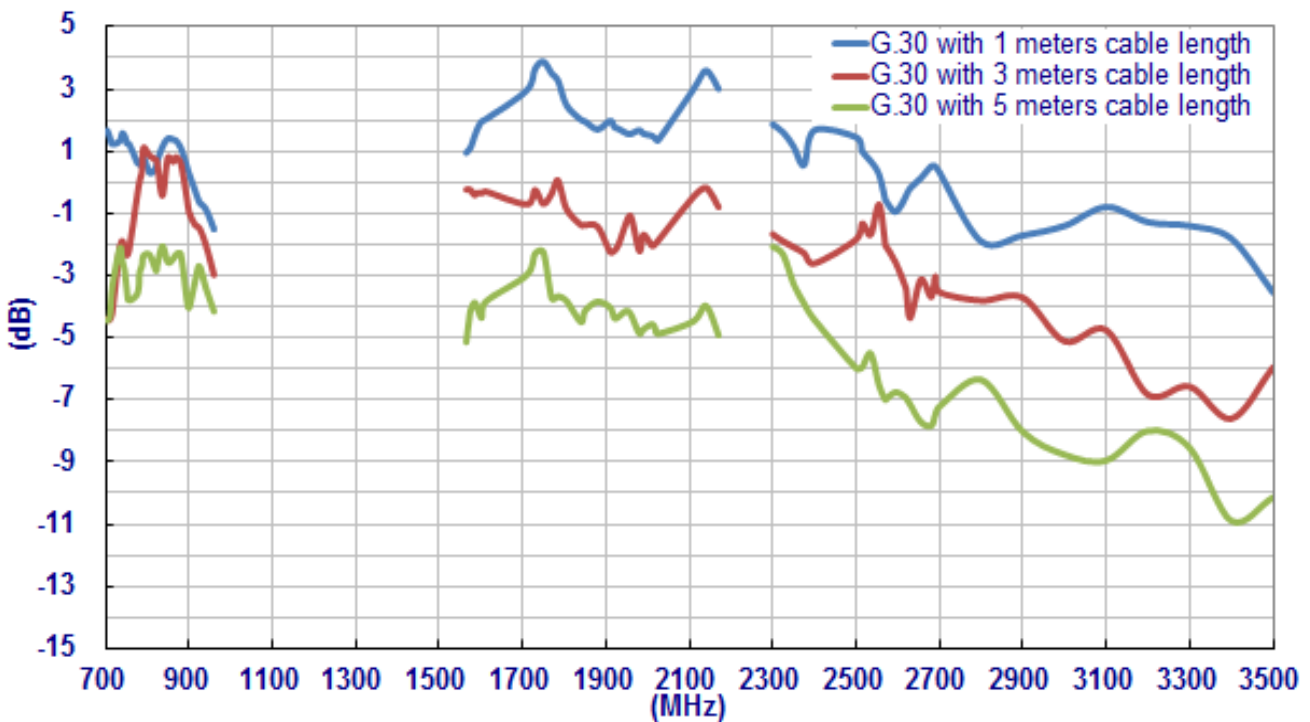

Figure7. On L-shaped bracket

3.4. Efficiency

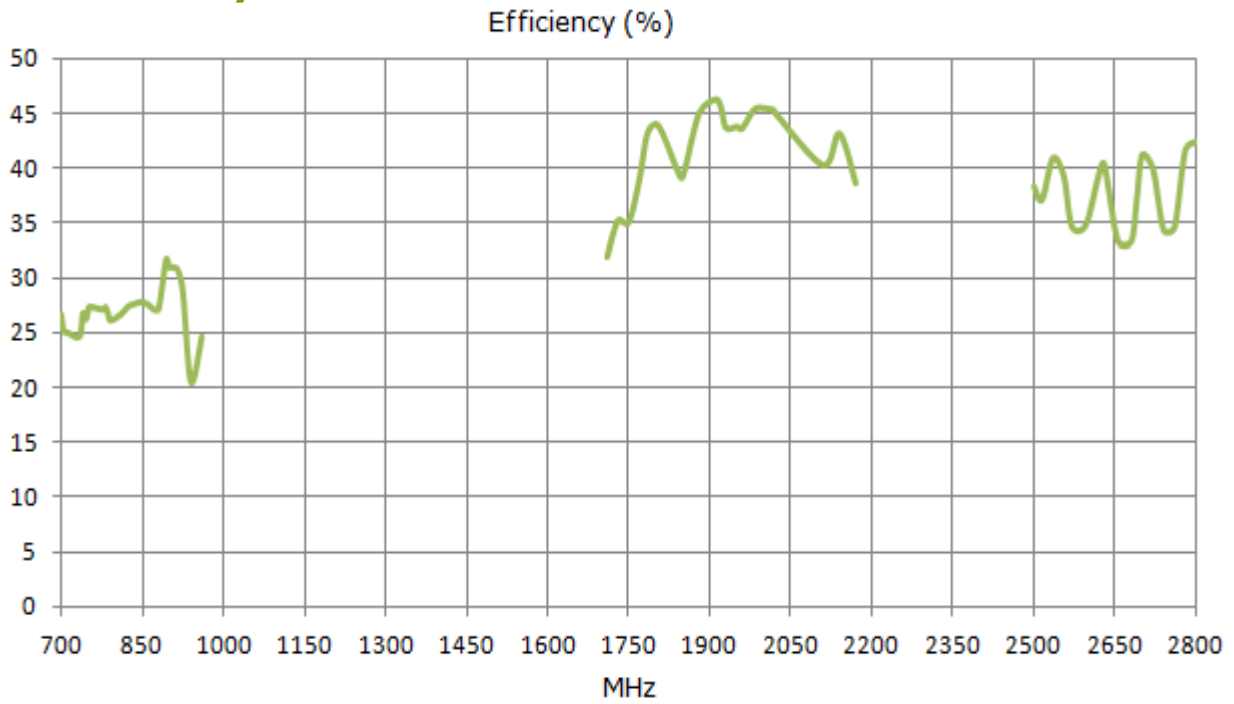

Figure8. In Free Space with 1 meter cable length

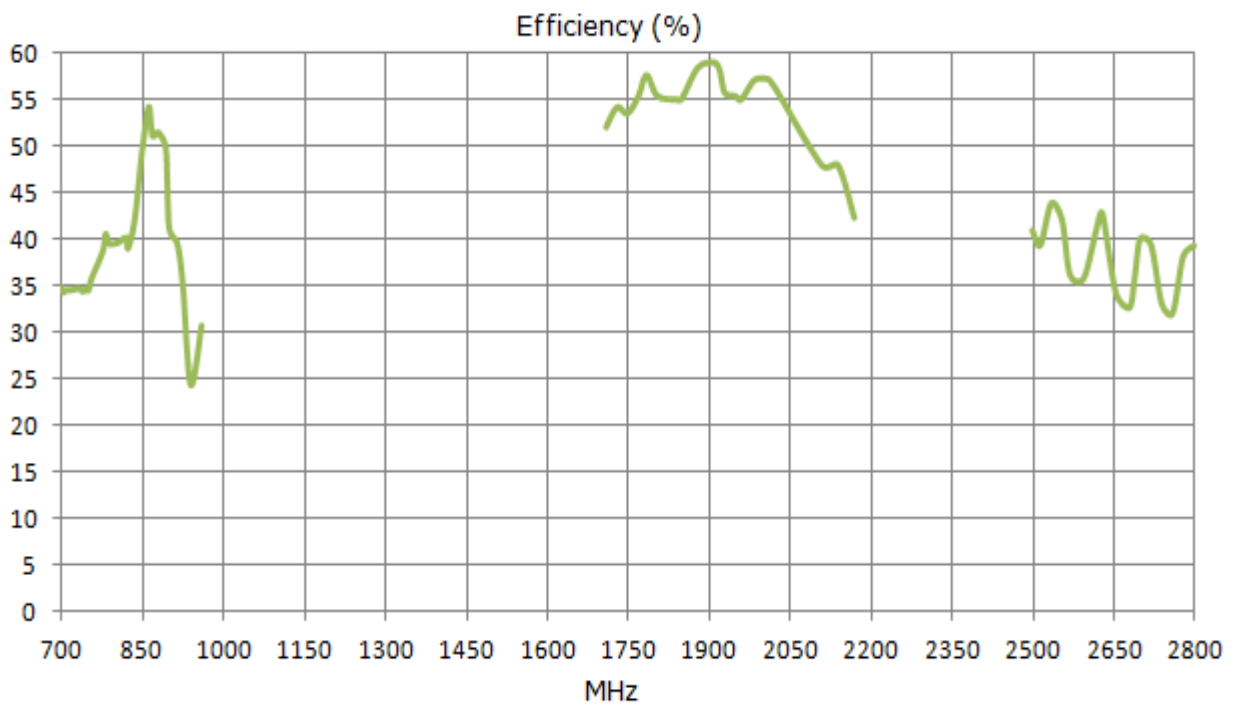

Figure9. On 30x30cm metal with 1 meter cable length

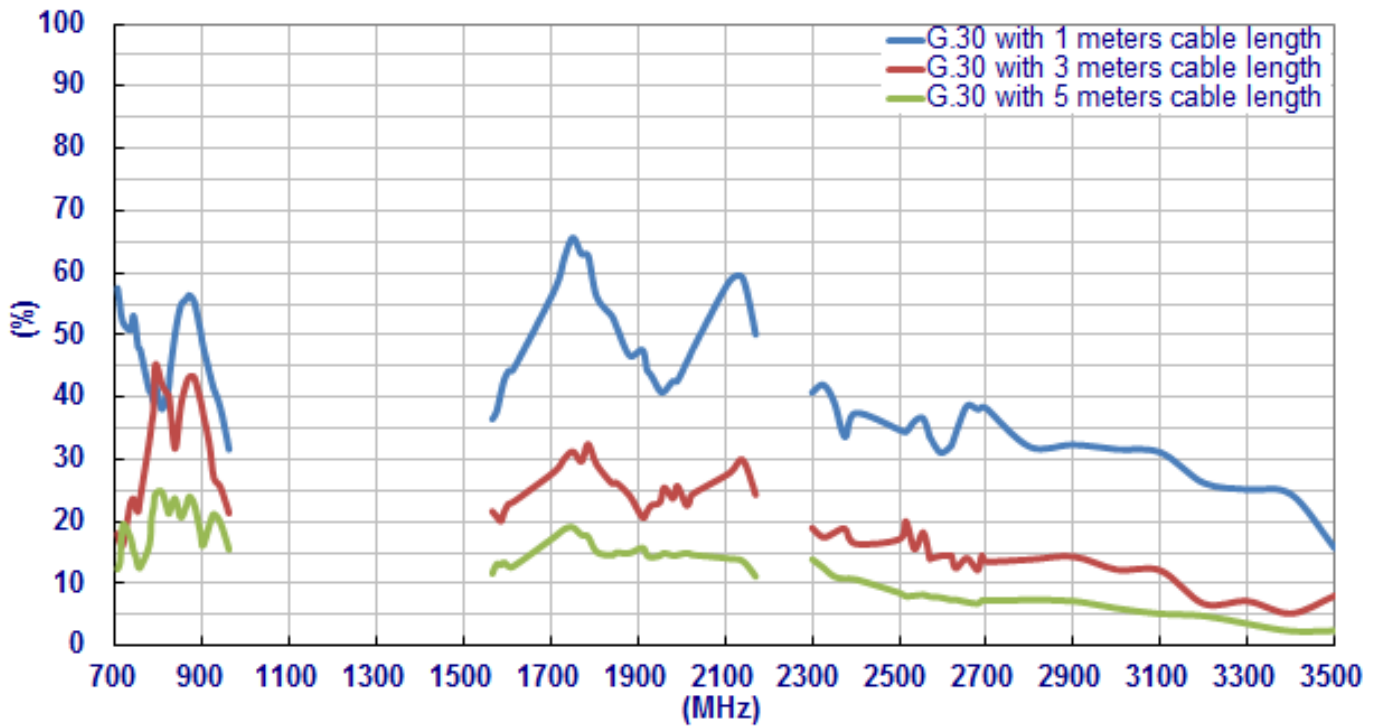

Figure10. On L-shaped bracket

3.5. Average Gain

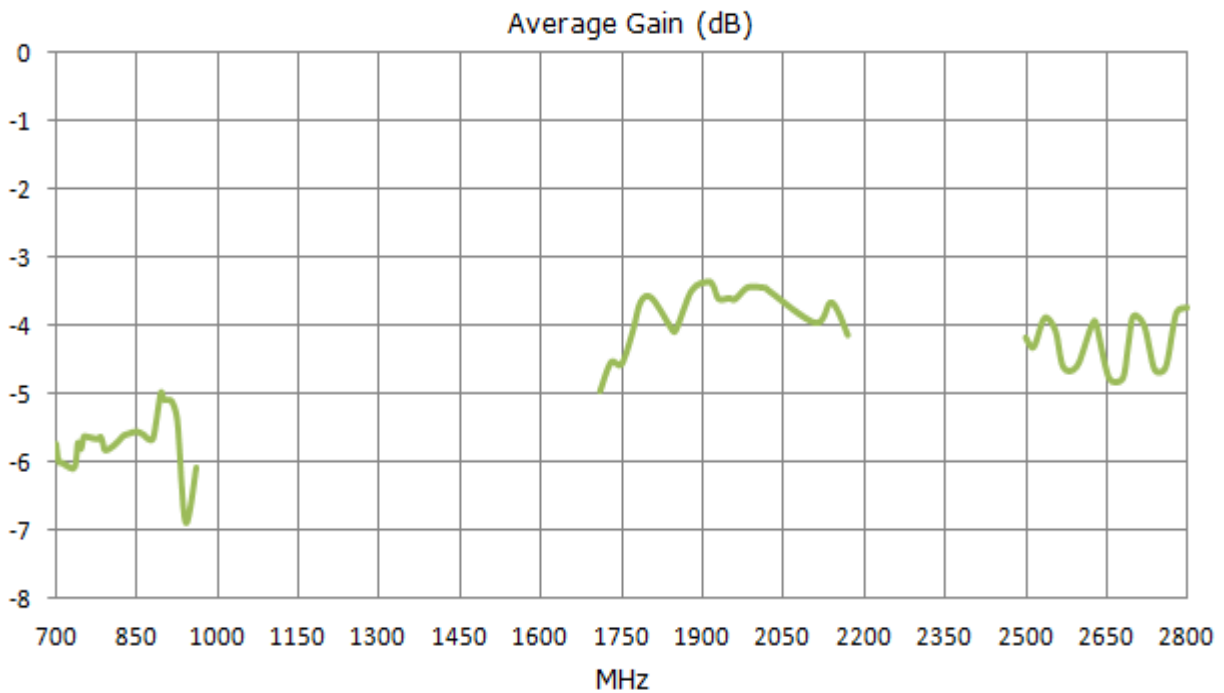

Figure11. In Free Space with 1 meter cable length

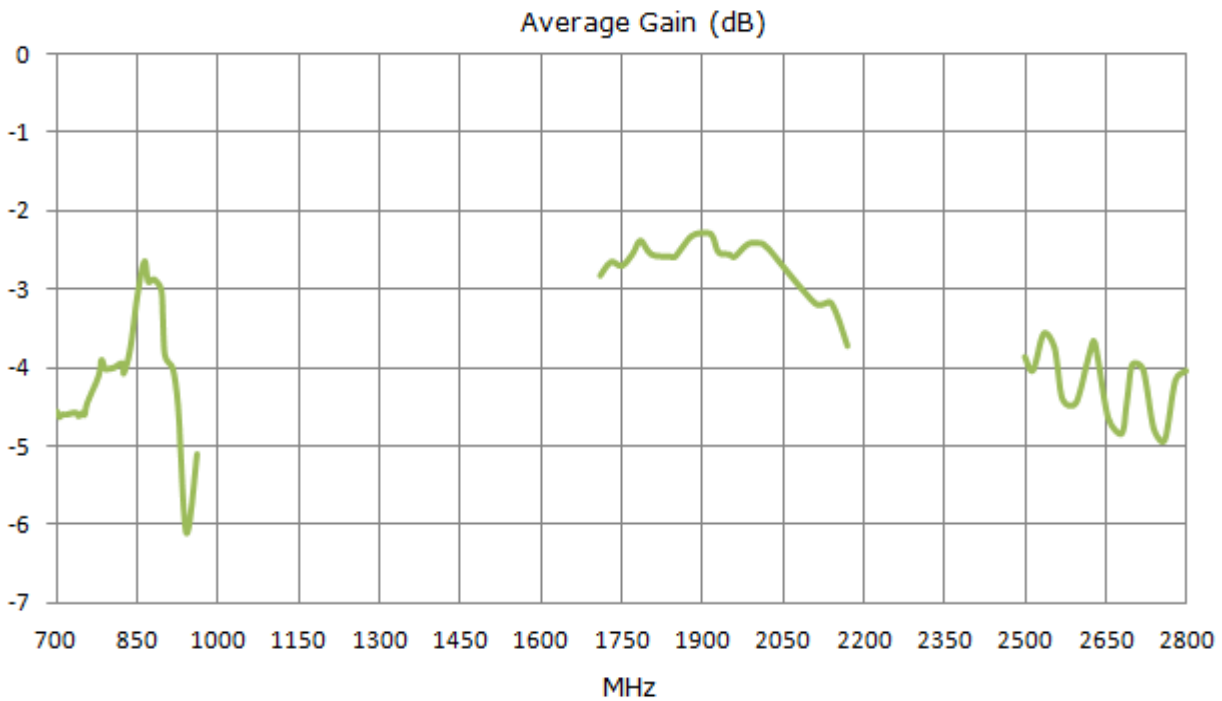

Figure12. On 30x30cm metal with 1 meter cable length

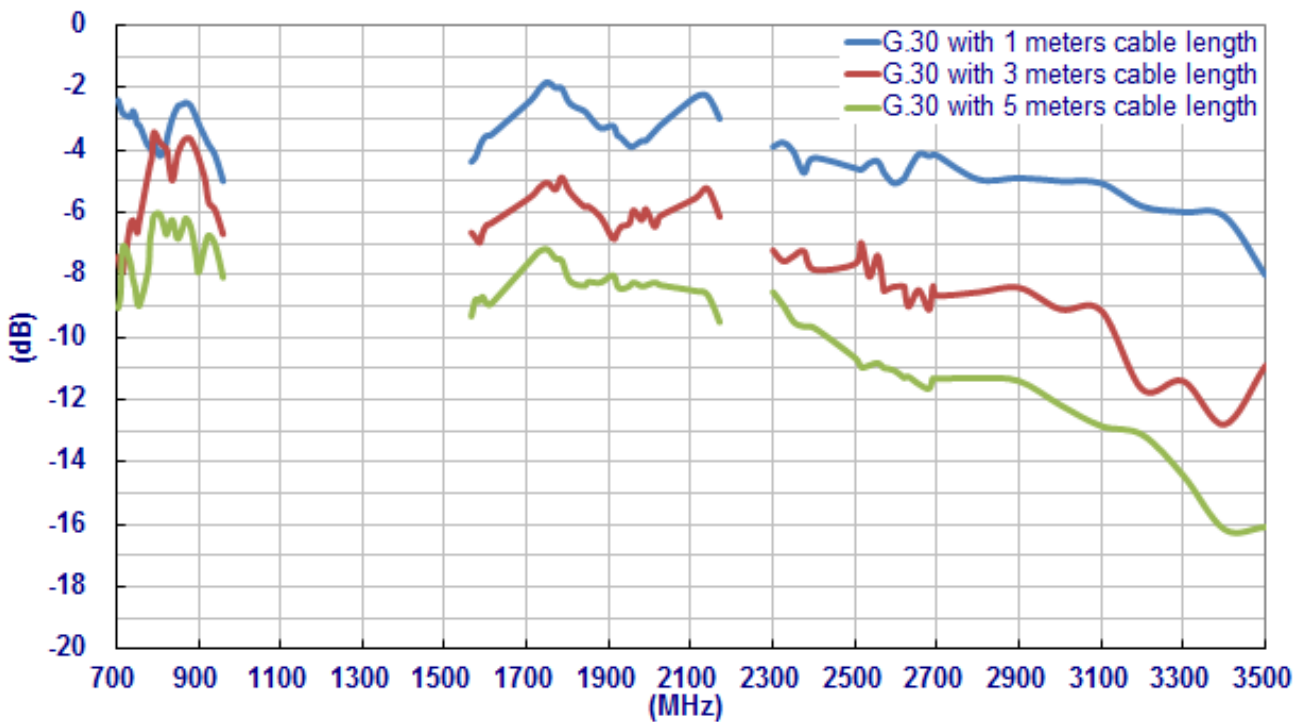

Figure13. On L-shaped bracket

4. Antenna Radiation Patterns

4.1. Antenna setup

The antenna radiation pattern measured setup as shown the below:

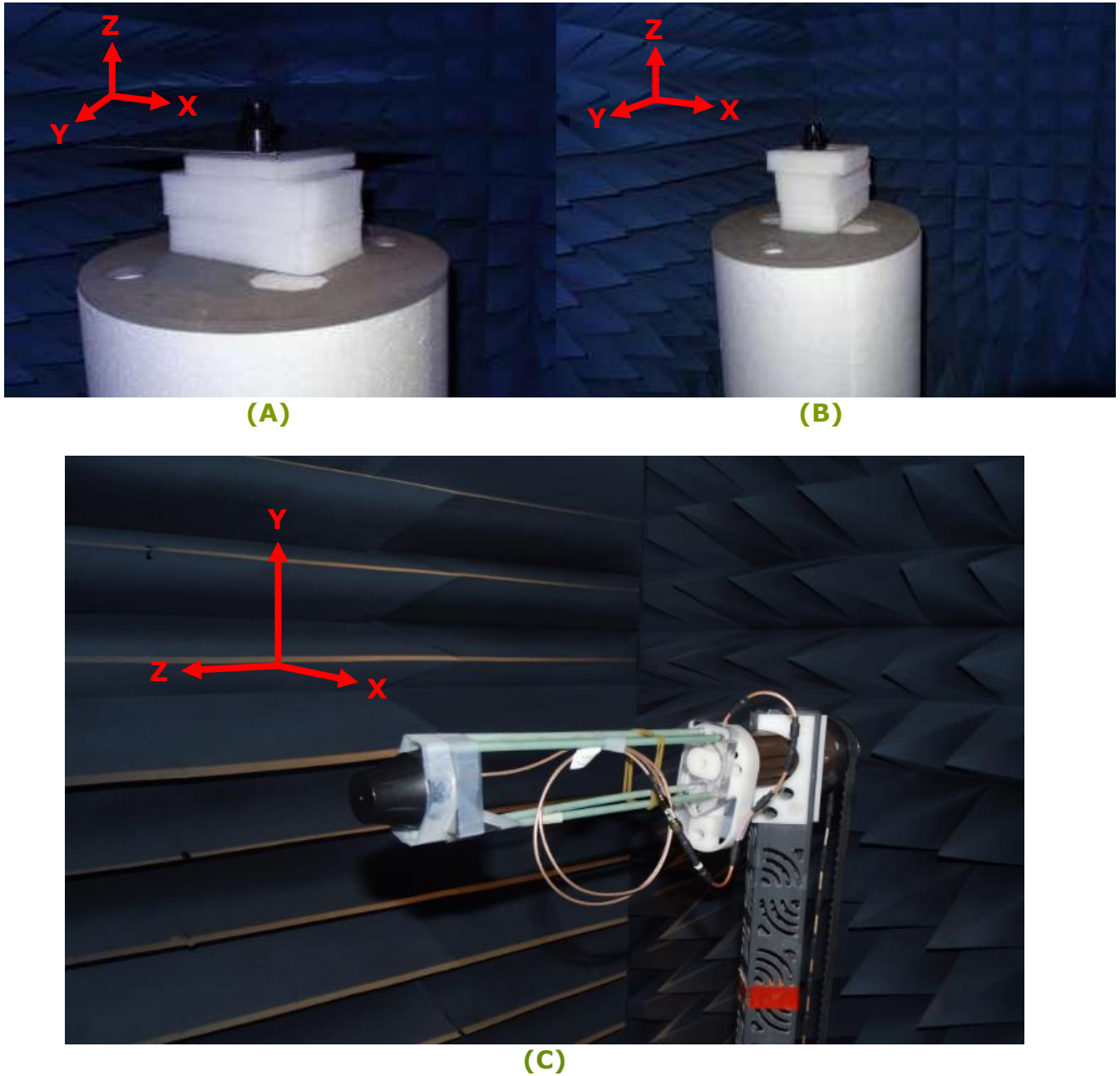

Figure14. Antenna radiation pattern measured setup

4.2. Antenna radiation patterns

4.2.1. In free space, Figure 14(A) as reference (dB)

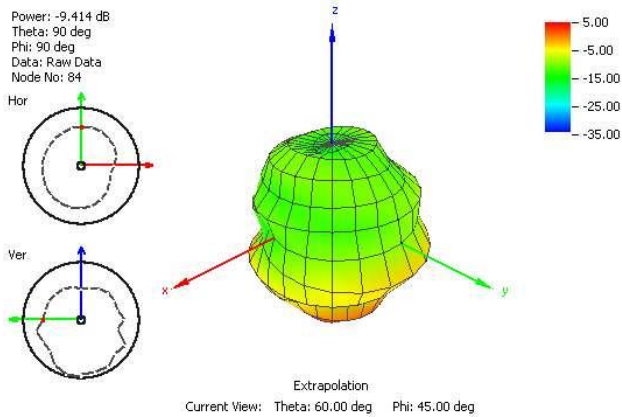

Figure15. Radiation Pattern at 751 MHz of G30 Antenna with 1 meter cable length

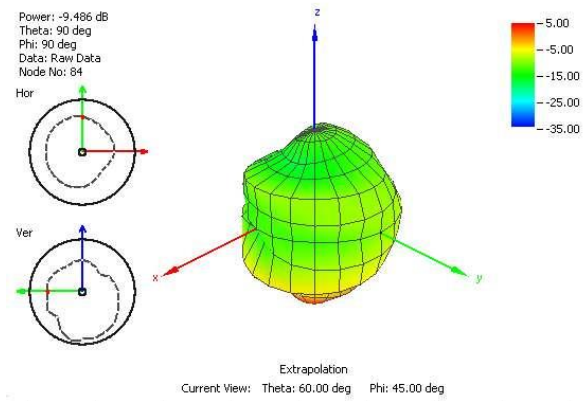

Figure16. Radiation Pattern at 849 MHz of G30 Antenna with 1 meter cable length

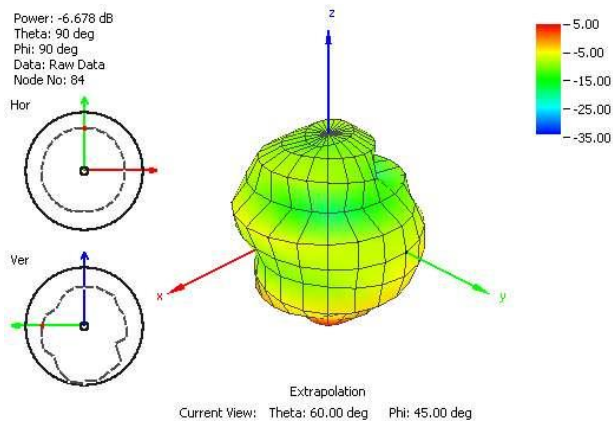

Figure17. Radiation Pattern at 915 MHz of G30 Antenna with 1 meter cable length

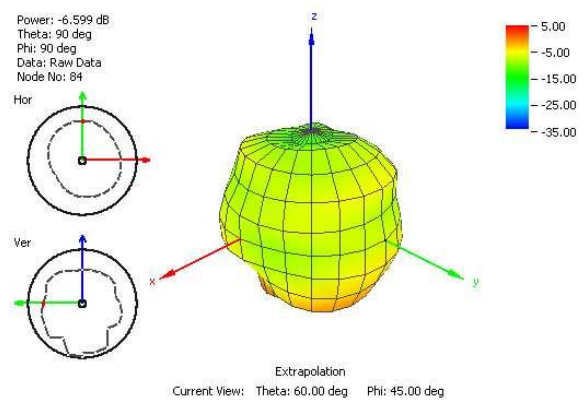

Figure18. Radiation Pattern at 1710 MHz of G30 Antenna with 1 meter cable length

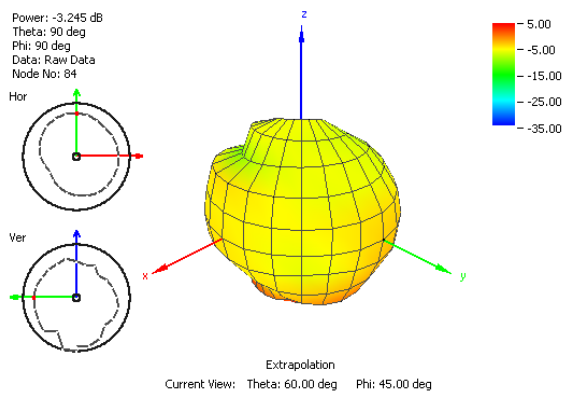

Figure19. Radiation Pattern at 1805 MHz of G30 Antenna with 1 meter cable length

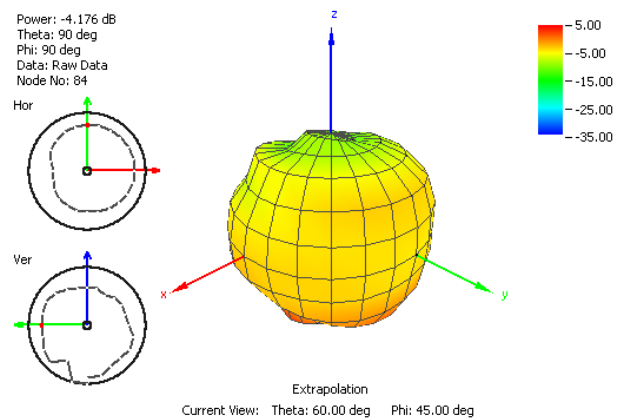

Figure20. Radiation Pattern at 1910 MHz of G30 Antenna with 1 meter cable length

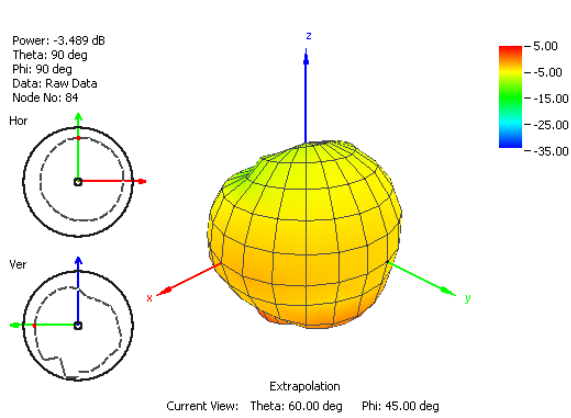

Figure21. Radiation Pattern at 1990 MHz of G30 Antenna with 1 meter cable length

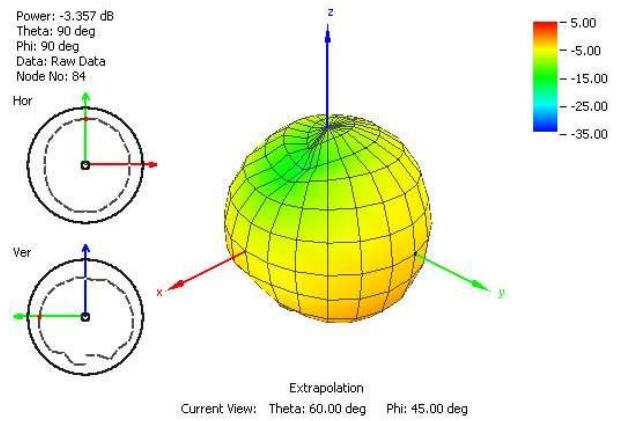

Figure22. Radiation Pattern at 2100 MHz of G30 Antenna with 1 meter cable length

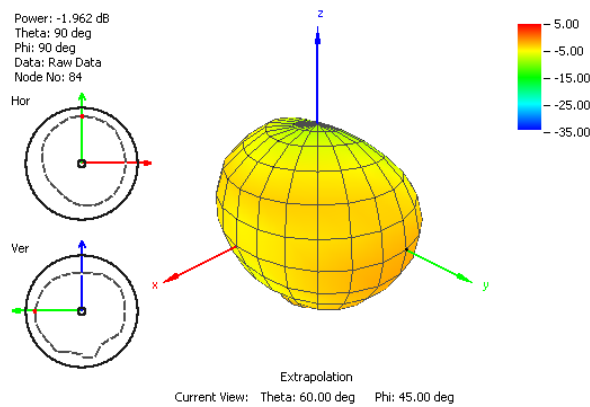

Figure23. Radiation Pattern at 2600 MHz of G30 Antenna with 1 meter cable length

4.2.2. On 30X30cm metal Figure 14(B) as reference (dB)

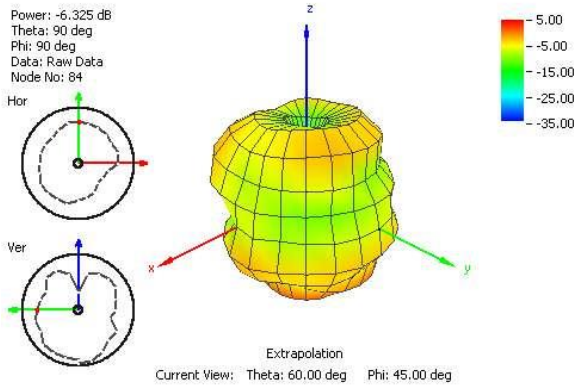

Figure24. Radiation Pattern at 751 MHz of G30 Antenna with 1 meter cable length

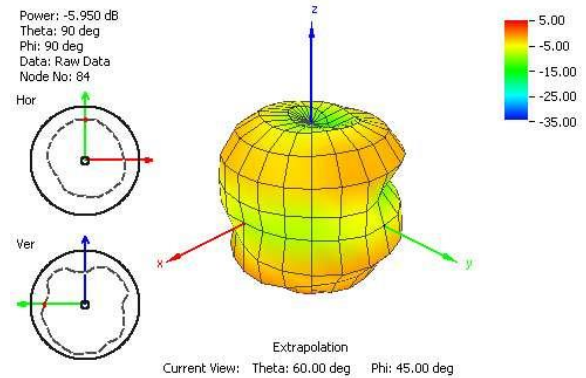

Figure25. Radiation Pattern at 849 MHz of G30 Antenna with 1 meter cable length

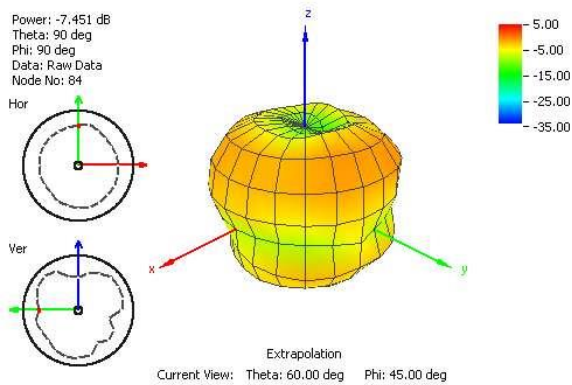

Figure26. Radiation Pattern at 915 MHz of G30 Antenna with 1 meter cable length

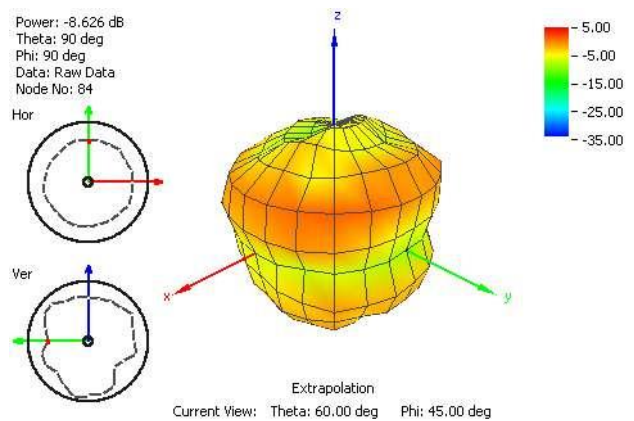

Figure27. Radiation Pattern at 1710 MHz of G30 Antenna with 1 meter cable length

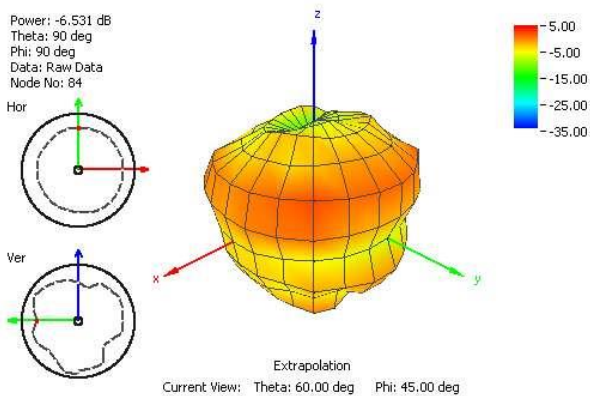

Figure28. Radiation Pattern at 1805 MHz of G30 Antenna with 1 meter cable length

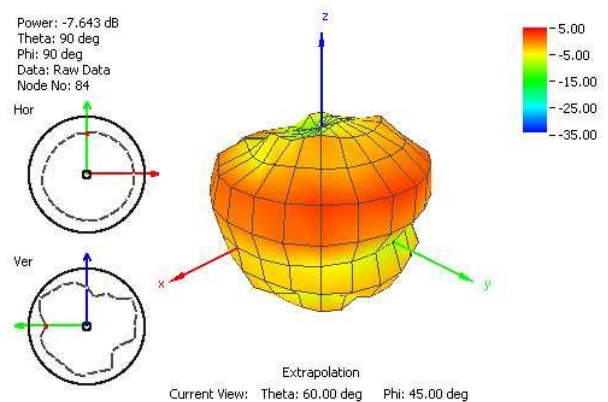

Figure29. Radiation Pattern at 1910 MHz of G30 Antenna with 1 meter cable length

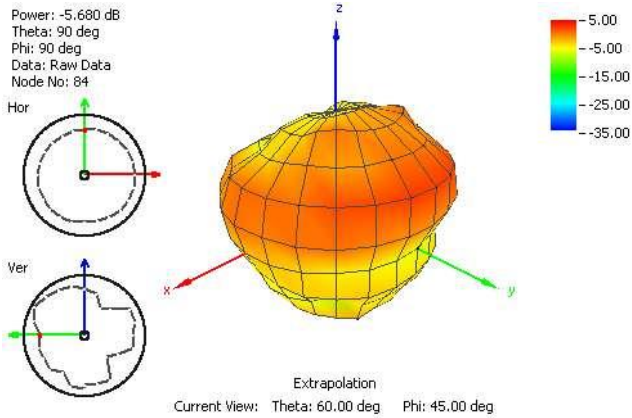

Figure30. Radiation Pattern at 1990 MHz of G30 Antenna with 1 meter cable length

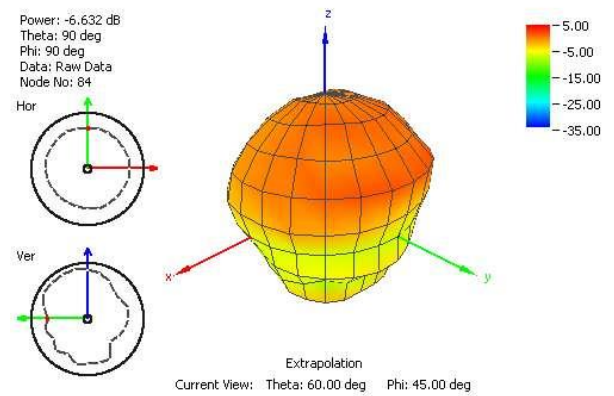

Figure31. Radiation Pattern at 2110 MHz of Antenna with 1 meter cable length

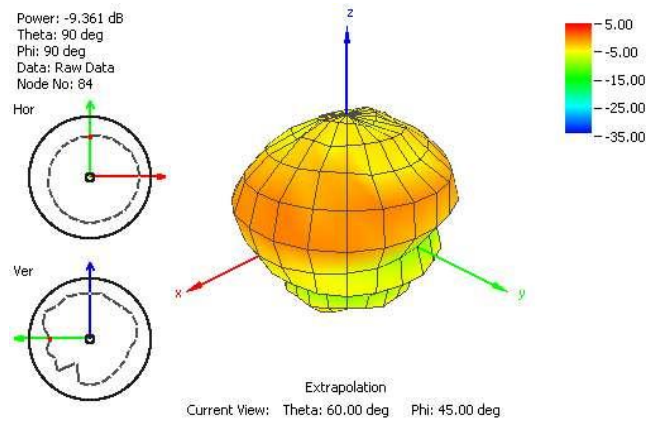
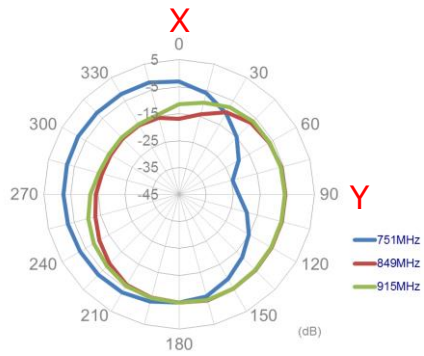

Figure32. Radiation Pattern at 2595 MHz of Antenna with 1 meter cable length

4.2.3. On L-shaped bracket, Figure 14(C) as reference (dB)

XY Plane



XZ Plane

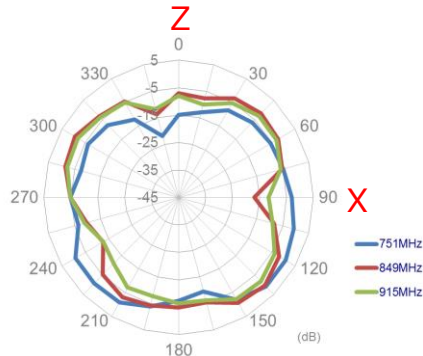

YZ Plane

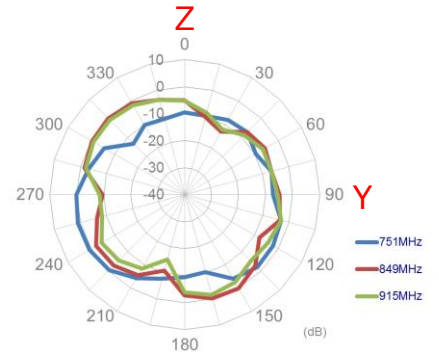

X

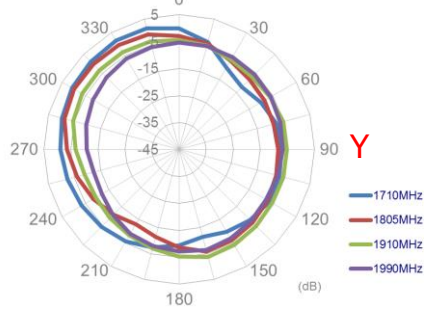

Z

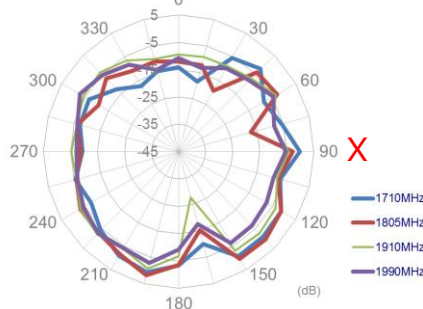

Z

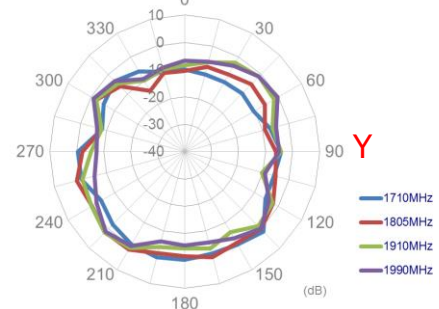

X

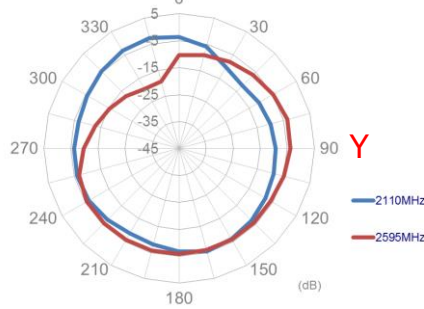

Z

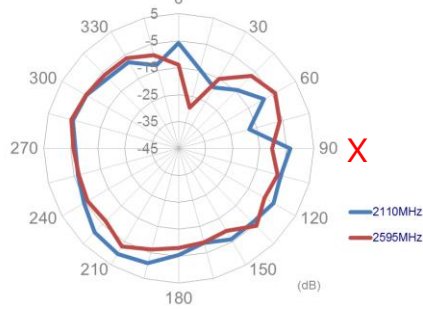

Z

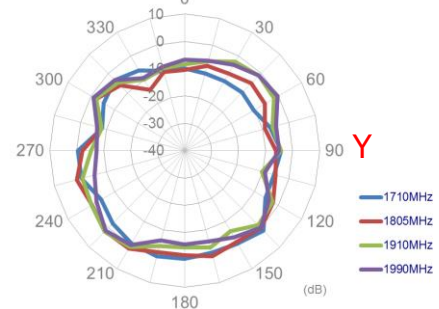

5. Mechanical Drawing (Unit: mm)

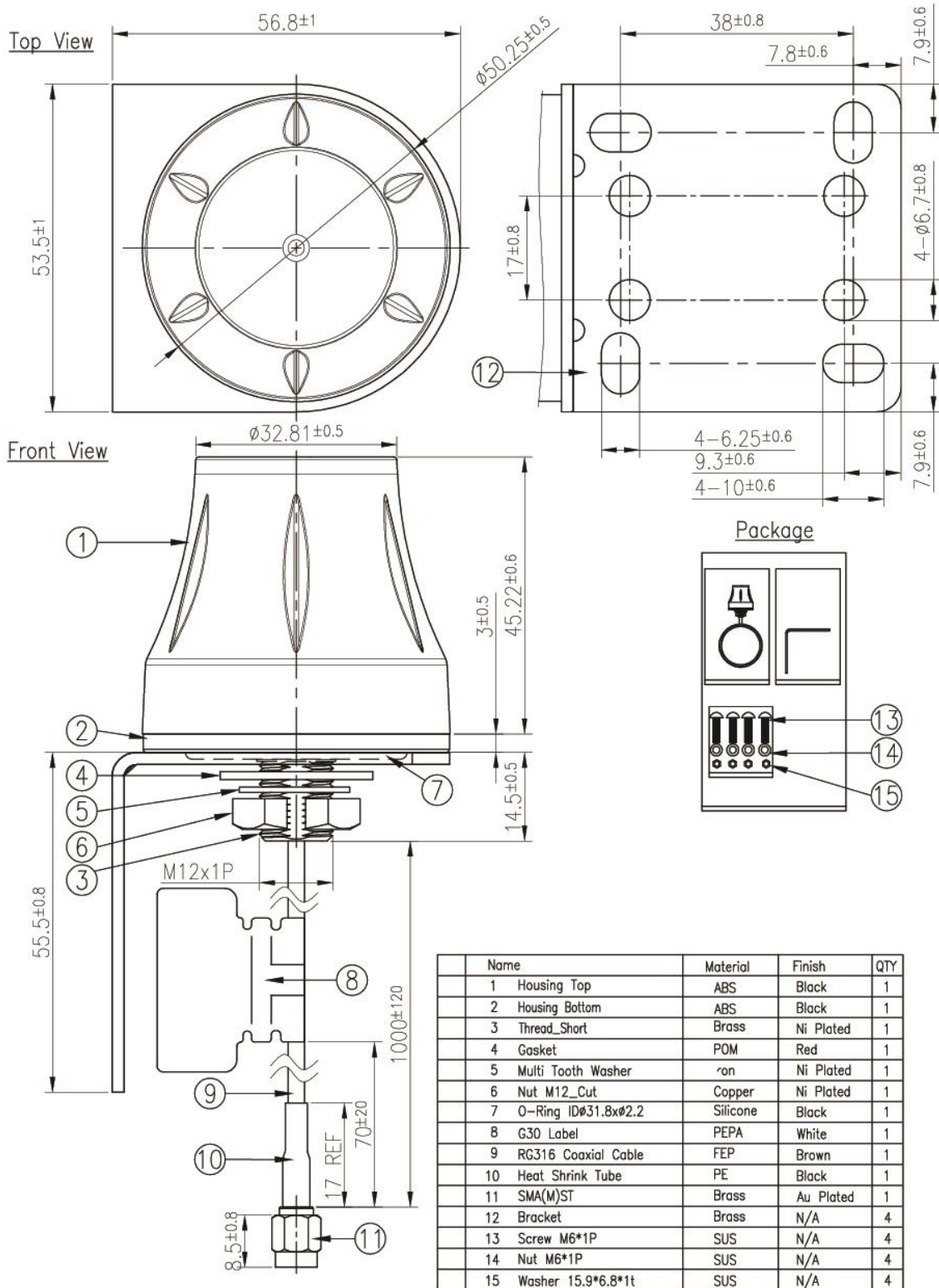

6. Packaging

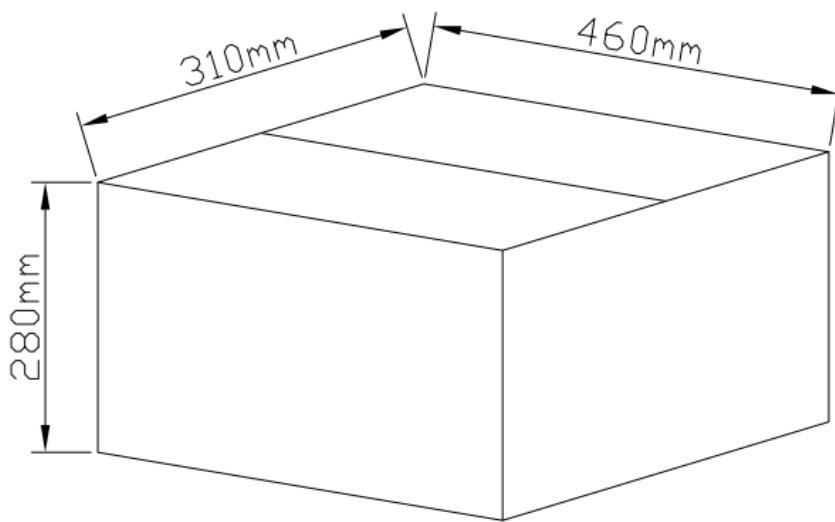

50 PCS PE Bag/ Carton = 50 PCS Antenna

Weight / carton = 9.33 Kg

Package view

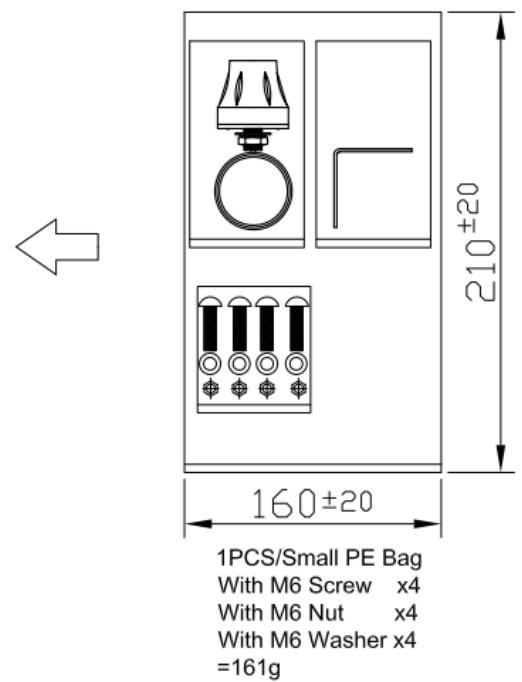

7. Installation

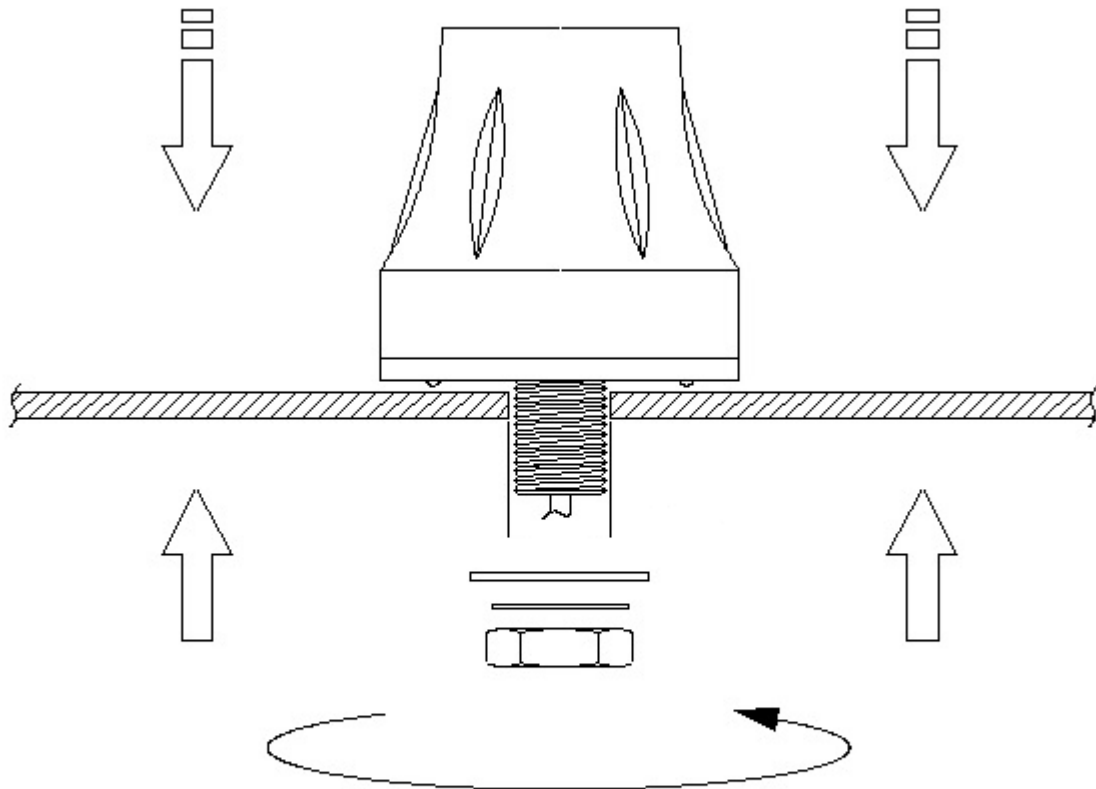

Recommended torque for mounting is 2.94N·m

Maximum torque for mounting is 3.92N·m

Taoglas makes no warranties based on the accuracy or completeness of the contents of this document and reserves the right to make changes to specifications and product descriptions at any time without notice. Taoglas reserves all rights to this document and the information contained herein.

Reproduction, use or disclosure to third parties without express permission is strictly prohibited.

Copyright © Taoglas Ltd.