

Type MJS

Lightning Surge Withstand Fuse

HF  MJS Series, 5x15mm Glass Tube Lightning Surge Withstand Fuse RoHS Compliant

Description

MJS fuses have been used for Tip and Ring protection in telecommunication circuits. And they continue to be used in legacy designs. However, with advent of new issues of IEC/UL 60950 and Telcordia GR-1089(Issue 3). MJS fuses may no longer meet all test requirements, depending on the end product circuit design.



Features

- Meet UL and CSA standard 248-14
- Wide operating temperature range
- Bulk and Tape & Reel packing available
- Full compliance with EU Directive 2011/65/EU and amending directive 2015/863
- Halogen Free
- Lead Free

Applications

Provide individual protection for components or internal circuits.

- Power supplies
- Battery charger
- Monitor
- Adapter
- Telecom protection

LEAD FREE = 
 HALOGEN FREE = 



Physical Specifications

Materials	Body : Glass
	Cap : Nickel Plated Brass Caps
	Leads : Matte Tin Plated Copper, Diameter 0.032"
Marking	On Fuse :
	"bel", "MJS", "Current Rating", "Voltage Rating",
	"Appropriate Safety Logos", "✓" (RoHS compliant)
	On Label :
	"bel", "MJS", "Current Rating", "Voltage Rating", "Interrupting Rating",
	"Appropriate Safety Logos" and "✓", "RoHS", "E" (China RoHS compliant).

Electrical Characteristics (UL/CSA STD.248-14)

Testing Current	Blow Time	
	Minimum	Maximum
100%	4 hrs.	N/A
135%	N/A	1 Hr.
200%	3 sec	20 sec
500%	100 msec	1.5 sec
1000%	30 msec	300 msec

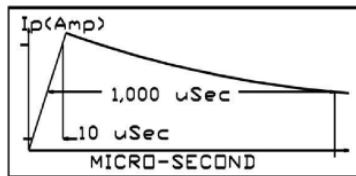





FIG A

Safety Agency Approvals

Safety Agency	Safety Agency Certificate	Ampere Rating/ Voltage Rating	Ampere Range / Volt @ I.R. ability*
	E20624	500mA-7A/ 250V AC	500mA-7A/125V AC@10,000A
	LR39772		500mA-7A/250V AC@200A
	JET1037-31003-1011		1A-5A/125V AC@500A
*I.R.= Interrupting Rating = Short Circuit Rating(Amps)			

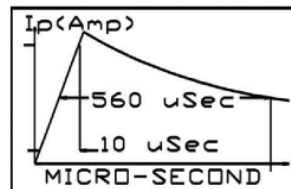





FIG B

Environmental Specifications

Shock Resistance	MIL-STD-202G, Method 213B, Test Condition 1 (100 G's peak for 6 milliseconds; Sawtooth waveform)
Vibration Resistance	MIL-STD-202G, Method 201A (10-55 Hz, 0.06 inch, total excursion).
Salt Spray Resistance	MIL-STD-202G, Method 101E, Test Condition B (48 hrs.).
Insulation Resistance	MIL-STD-202G, Method 302, Test Condition A (After Opening) 10,000 ohms minimum.
Solderability	MIL-STD-202G, Method 208H
Resistance to solder Heat	MIL-STD-202G, Method 210F, Test Condition B (260+/-5°C, 10+/-1 sec)
Thermal Shock	MIL-STD-202G, Method 107G, Test Condition B (-65°C to +125°C).
Operating Temperature	-55°C to +125°C
Terminal Strength	IEC-68-2-21

Electrical Specifications

Catalog Number	Ampere Rating	Typical Cold Resistance (ohm)	Volt-drop @100%In (Volt) max.	Voltage and Interrupting Ratings	Melting I ² T <10 mSec (A ² Sec)	Melting I ² T @10 In (A ² Sec)	Peak Surge Current (Amp)		Maximum Power Dissipation (W)	Agency Approvals		
							(Flg A) 25 Pulses 10uS x 1000uS	(Flg B) 50 Pulses 10uS x 560uS				
MJS 500-R	500mA	0.630	0.59	See Table of Safety Approvals on Page 1 for Voltage and associated Interrupting Ratings	1.6	2.0	26	35	0.47	Y	Y	
MJS 600-R	600mA	0.440	0.53		2.2	2.3	29	33	0.49	Y	Y	
MJS 700-R	700mA	0.341	0.49		3.0	4.0	38	50	0.54	Y	Y	
MJS 750-R	750mA	0.326	0.48		3.0	4.0	38	50	0.55	Y	Y	
MJS 800-R	800mA	0.250	0.42		5.0	7.0	50	66	0.60	Y	Y	
MJS 1-R	1A	0.195	0.39		5.9	7.8	56	75	0.64	Y	Y	Y
MJS 1.25-R	1.25A	0.130	0.34		9.3	12	75	100	0.71	Y	Y	Y
MJS 1.5-R	1.5A	0.100	0.29		15	19	94	125	0.80	Y	Y	Y
MJS 2-R	2A	0.061	0.26		23	30	120	160	0.89	Y	Y	Y
MJS 2.5-R	2.5A	0.046	0.22		35	47	150	200	0.99	Y	Y	Y
MJS 3-R	3A	0.037	0.19		55	73	195	260	1.10	Y	Y	Y
MJS 3.5-R	3.5A	0.029	0.18		69	91	225	300	1.16	Y	Y	Y
MJS 4-R	4A	0.024	0.17		86	114	255	340	1.22	Y	Y	Y
MJS 5-R	5A	0.019	0.15		135	179	330	440	1.36	Y	Y	Y
MJS 6-R	6A	0.015	0.13		211	279	428	570	1.51	Y	Y	
MJS 7-R	7A	0.012	0.12		263	350	488	650	1.60	Y	Y	

Consult manufacturer for other ratings



Specifications subject to change without notice

Bel Fuse Inc.
206 Van Vorst Street
Jersey City, NJ 07302 USA

+1 201.432.0463
Bel.US.CS@belf.com
belfuse.com/circuit-protection

Temperature Derating Curve

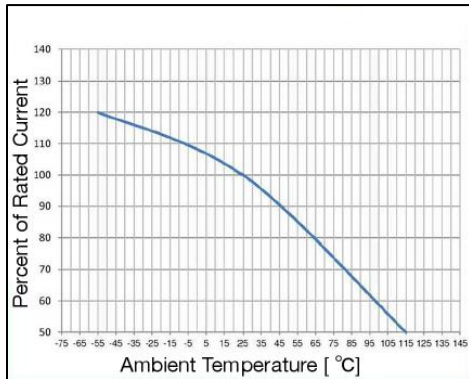

Average Time Current Curve

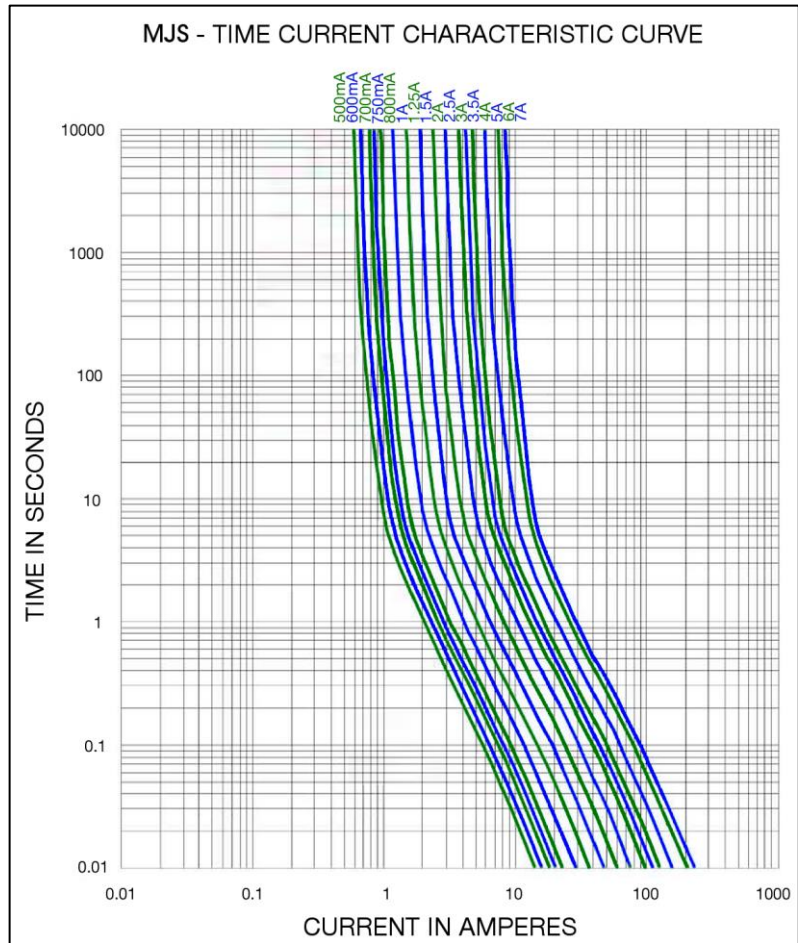

Soldering parameters

Lead-free Wave Soldering Profile	
Wave Soldering Parameter	
Average ramp-up rate	200°C / second
Heating rate during preheat	typical 1 - 2°C / second Max 4°C / second
Final preheat temperature	within 125°C of soldering temperature
Peak temperature T _p	260°C
Time within +0°C / -5°C of actual peak temperature	10 seconds
Ramp-down rate	5°C / second max.

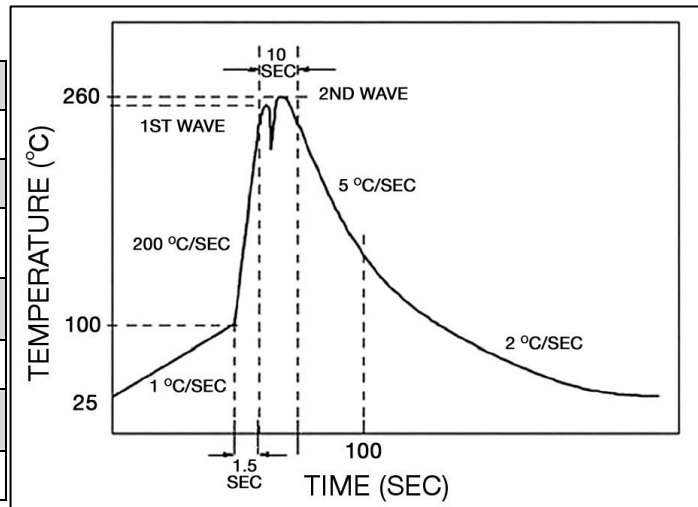

Fuse FGNO Explanation

0653 R [XXXX] -XX

0653R=MJS; [XXXX]=Ampere Rating; XX=See Ordering Information as below

Fraction	Decimal	Milliamps	Bel FGNO[XXXX]
1/2	.500	500	0500
6/10	.600	600	0600
7/10	.700	700	0700
3/4	.750	750	0750
8/10	.800	800	0800

Fraction	Decimal	Amps	Bel FGNO[XXXX]
	1.0	1	1000
1-1/4	1.25	1.25	1250
1-1/2	1.50	1.5	1500
	2.0	2	2000
2-1/2	2.5	2.5	2500
	3.0	3	3000
3-1/2	3.5	3.5	3500
	4.0	4	4000
	5.0	5	5000
	6.0	6	6000
	7.0	7	7000

Mechanical Dimensions

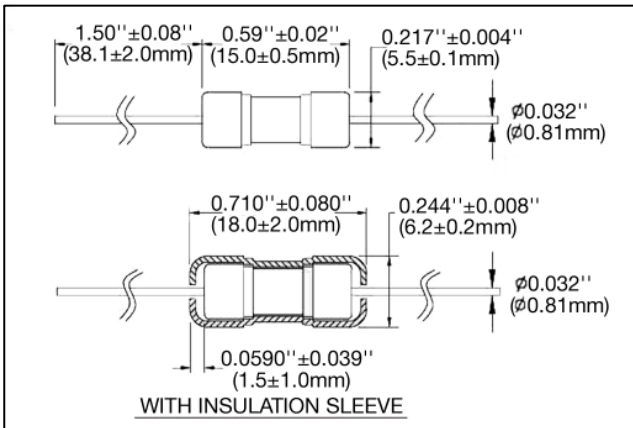

*Diameter lead 0.032"±0.002" for all ratings

Ordering Information

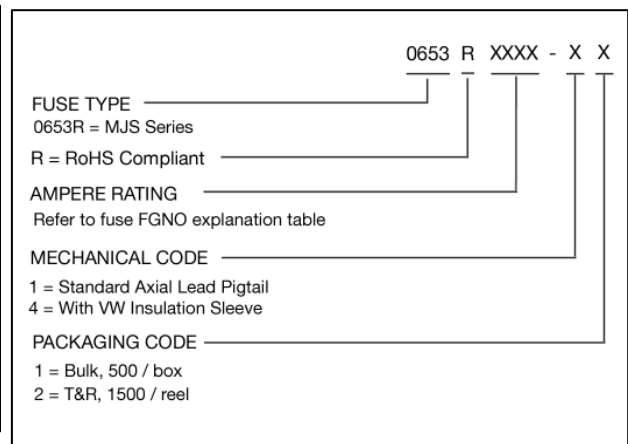

Packaging

Packaging Option	Packaging Specification	Quantity	Packaging Code	Inside Tape Spacing
Bulk (Pigtail Type)	N/A	500	11	N/A
Bulk (Pigtail Type) with Insulation Sleeve	N/A	500	41	N/A
Tape & Reel	EIA-296-F	1500	12	10mm Pitch and 53mm
Tape& Reel with Insulation Sleeve	EIA-296-F	1500	42	10mm Pitch and 53mm