

0RQB-C2Q12x

Isolated DC-DC Converter

The 0RQB-C2Q12x is an isolated DC/DC converter that operates from a nominal 24 VDC source. This unit will provide up to 156 W of output power from a nominal 24 VDC input.

This unit is designed to be highly efficient and low cost. Features include remote on/off, over current protection and over voltage protection.

The converter is provided in an industry standard quarter brick package.



Key Features & Benefits

- 9-36 VDC Input
- 12 VDC @ 13 A Output
- 1/4th Brick Converter
- Fixed Frequency
- High Efficiency
- High Power Density
- Low Cost
- Input Under Voltage Lockout
- Input Over Voltage Lockout
- OCP/SCP
- Output Over-Voltage Protection
- Over Temperature Protection
- Remote On/Off
- Basic Isolation
- Approved to UL/CSA 62368-1 (Except 0RQB-C2Q12V)
- Approved to IEC/EN 62368-1 (Except 0RQB-C2Q12V)
- Class II, Category 2, Isolated DC/DC Converter (refer to IPC-9592B)

Applications

- Networking
- Computers and peripherals
- Telecommunications

1. MODEL SELECTION

MODEL NUMBER	OUTPUT VOLTAGE	INPUT VOLTAGE	MAX. OUTPUT CURRENT	MAX. OUTPUT POWER	TYPICAL EFFICIENCY
0RQB-C2Q120	12 VDC	9 – 36 VDC	13 A	156 W	94%
0RQB-C2Q12L	12 VDC	9 – 36 VDC	13 A	156 W	94%
0RQB-C2Q12V	12 VDC	9 – 36 VDC	13 A	156 W	94%

NOTE: Add “G” suffix at the end of the model number to indicate Tray Packaging.

PART NUMBER EXPLANATION

0	R	QB	-	C2	Q	12	x	y
Mounting Type	RoHS Status	Series Name		Output Power	Input Range	Output Voltage	Active Logic	Package Type
Through hole mount	RoHS	1/4th Brick		156 W	9 – 36 V	12 V	L – Active Low, with Baseplate 0 – Active High, with Baseplate V – Active Low, Open Frame	G – Tray package

2. ABSOLUTE MAXIMUM RATINGS

PARAMETER	DESCRIPTION	MIN	TYP	MAX	UNITS
Continuous non-operating Input Voltage		-0.3	-	36	V
Input Transient Voltage	100 ms maximum	-	-	50	V
Input Withstand Voltage	100 ms for working, 1 minute for non-work without damage.	-	-	48	V
Remote On/Off		-0.3	-	18	V
I/O isolation voltage		-	-	1500	V
Ambient temperature		-40	-	85	°C
Storage Temperature		-55	-	125	°C
Relative humidity range		10	-	90	%
Altitude		-	-	5000	m

NOTE: Ratings used beyond the maximum ratings may cause a reliability degradation of the converter or may permanently damage the device.

3. INPUT SPECIFICATIONS

PARAMETER	DESCRIPTION	MIN	TYP	MAX	UNIT
Operating Input Voltage		9	24	36	V
Input Current (full load)	Test at 9 V input voltage	-	-	20.0	A
Input Current (no load)		-	200	240	mA
Remote Off Input Current		-	25	35	mA
Input Reflected Ripple Current (rms)	With simulated source impedance of 10 μ H, 5 Hz to 20 MHz. Use a 2*220 μ F/100 V electrolytic capacitor with ESR=1 ohm max, at 200 kHz @ 25°C.	-	5	10	mA
Input Reflected Ripple Current (pk-pk)		-	30	40	mA
I ² t Inrush Current Transient		-	0.05	0.1	A ² s
Turn-on Voltage Threshold	Input UVLO	9.5	10	10.5	V
Turn-off Voltage Threshold	Input UVLO	7.5	8	8.5	V
Turn-on Voltage Threshold	Input OVLO	36.5	38	39	V
Turn-off Voltage Threshold	Input OVLO	38.5	39.5	40.5	V
<i>Other Information</i>					
Input capacitance	4*4.7 μ F/50 V ceramic capacitor		18.8		μ F

NOTE: All specifications are typical at 25°C unless otherwise stated

CAUTION: This converter is not internally fused. An input line fuse must be used in application. Recommend input fast-acting fuse with Typical of 30 A on system board. Refer to the fuse manufacture's datasheet for further information.

4. OUTPUT SPECIFICATIONS

All specifications are typical at nominal input, full load at 25°C unless otherwise stated.

PARAMETER	DESCRIPTION	MIN	TYP	MAX	UNIT
Output Voltage Set Point	Vin = 24 V, Io = 50% load at 25°C ambient.	11.8	12.04	12.28	V
Load Regulation	Vin = 24 V, Io = 0~100% load at 25°C ambient.	-	±15	±30	mV
Line Regulation		-	±15	±30	mV
Regulation Over Temperature		-	±100	±200	mV
Output Ripple and Noise(Pk-Pk)	Vin = 24 V, Full load, 0 – 20 MHz BW, with a 1 µF ceramic capacitor and a 10 µF Tantalum cap and 220 µF Tantalum cap at output.	-	100	150	mV
Output Ripple and Noise(RMS)		-	25	40	mV
Output Current Range	The 0RQB-C2Q12x module can start up with 17 A for 10 0ms at Vin > 12 V.	0	-	13	A
Output DC Current Limit		15	20	25	A
Short Circuit Surge Transient		-	-	5	A ² s
Rise Time		-	12	20	ms
Turn On Time	Ton (Enable form Vin)	-	30	40	ms
	Ton (Enable form ON/OFF)	-	30	40	ms
Overshoot at Turn on		0	-	3	%
Pre-Bias Voltage		0	-	4	V
Output Capacitance	Note: The minimum output capacitance(220µF) must be low ESR capacitance, such as Tantalum capacitance or POSCAP, and the total ESR must bigger than 3 mΩ.	220	-	5000	µF
Transient Response					
ΔV 50%~75% of Max Load		-	400	500	mV
Settling Time	di/dt = 0.1 A/µs, Vin = 24 VDC, Ta = 25°C, with a 1 µF ceramic capacitor, a 10 µF Tantalum cap and 220 µF Tantalum cap at output.	-	200	300	µs
ΔV 75%~50% of Max Load		-	400	500	mV
Settling Time		-	200	300	µs

NOTE: All specifications are typical at nominal input, full load at 25°C unless otherwise stated.

5. GENERAL SPECIFICATIONS

PARAMETER	DESCRIPTION	MIN	TYP	MAX	UNIT
Efficiency	The efficiency is measured at Vin = 24 V, full load and Ta = 25°C.	92	94	-	%
Switching Frequency		-	200	-	kHz
Over Temperature Protection		-	125	130	°C
Over Voltage Protection (Static)	This voltage is achieved by trimming up output slowly.		15.3	15.8	V
FIT	Calculated Per Bell Core SR-332 (Vin = 24 V, Vo = 12 V, Io = 10.4 A, Ta = 58°C, FIT = 10 ⁹ /MTBF)	-	546	-	-
Weight	0RQB-C2Q120 & 0RQB-C2Q12L	-	64	-	g
Weight	0RQB-C2Q12V	-	TBC	-	g
Dimensions (L x W x H)	0RQB-C2Q120 & 0RQB-C2Q12L		2.30 x 1.45 x 0.50		inch
			58.42 x 36.83 x 12.70		mm
	0RQB-C2Q12V		2.30 x 1.45 x 0.45		inch
			58.42 x 36.83 x 11.50		mm
Isolation Characteristics					
Input to Output		-	-	1500	V
Input to Case	Except 0RQB-C2Q12V	-	-	1500	V
Output to Case	Except 0RQB-C2Q12V	-	-	500	V
Isolation Resistance		10M	-	-	Ohm
Isolation Capacitance		-	3900	-	pF

6. EFFICIENCY DATA

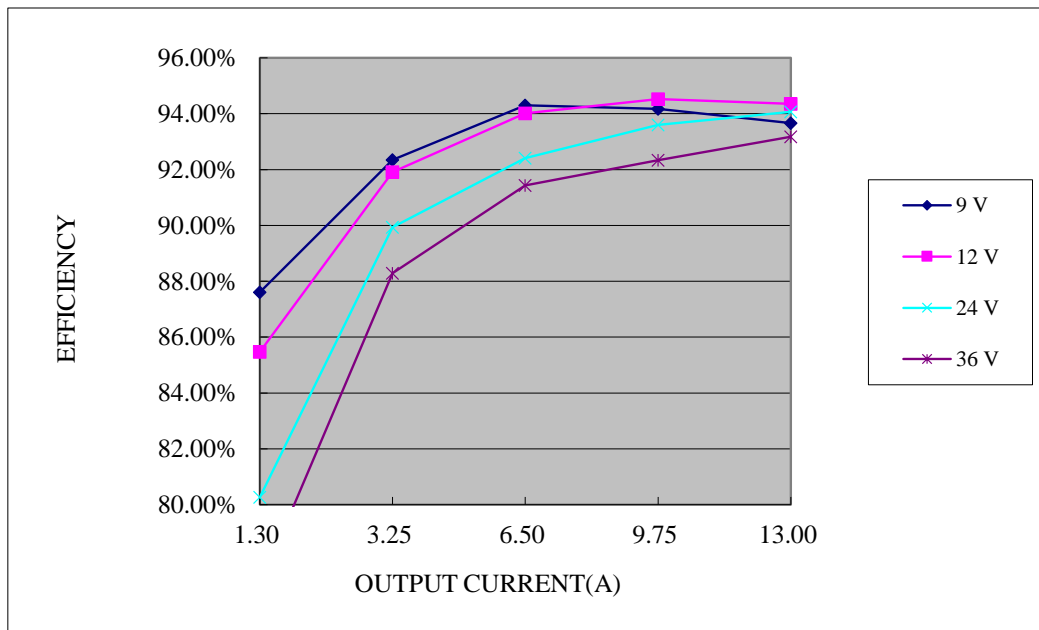

Figure 1. Efficiency data



Asia-Pacific
+86 755 298 85888

Europe, Middle East
+353 61 225 977

North America
+1 408 785 5200

7. REMOTE ON/OFF

PARAMETER		DESCRIPTION	MIN	TYP	MAX	UNIT
Signal Low (Unit On)	Active Low	Remote On/Off pin is open, the module is off.	-0.3	-	0.8	V
Signal High (Unit Off)			2.4	-	18	V
Signal Low (Unit Off)	Active High	Remote On/Off pin is open, the module is on.	2.4	-	18	V
Signal High (Unit On)			-0.3	-	0.8	V
Current Sink			0	-	1	mA

Recommended remote on/off circuit for active low

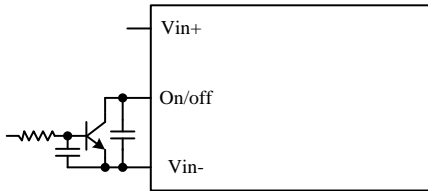

Figure 2. Control with open collector/drain circuit

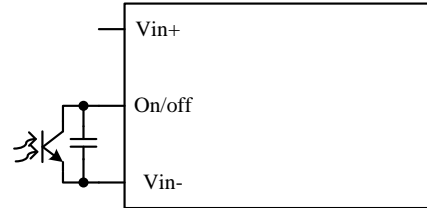

Figure 3. Control with photocoupler circuit

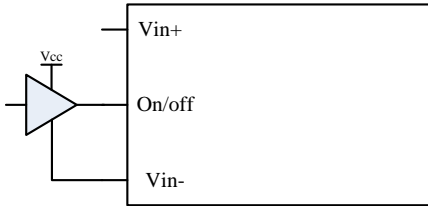

Figure 4. Control with logic circuit

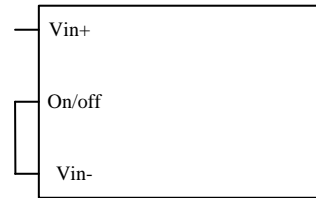

Figure 5. Permanently on

Recommended remote on/off circuit for active high

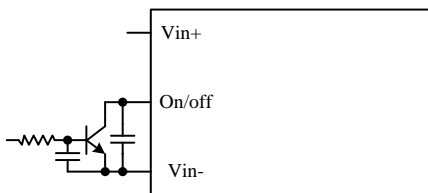

Figure 6. Control with open collector/drain circuit

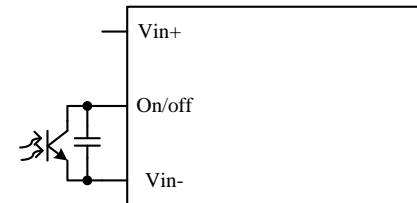

Figure 7. Control with photocoupler circuit

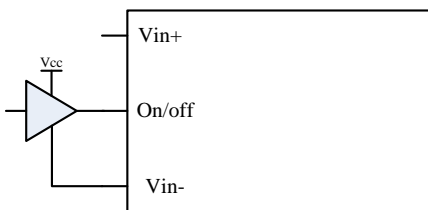

Figure 8. Control with logic circuit

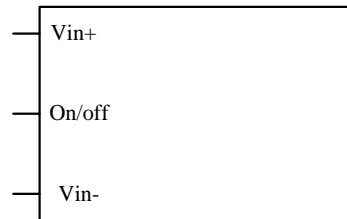

Figure 9. Permanently on

8. REMOTE SENSE

This module has remote sense compensation feature. It can minimize the effects of resistance between output and load in system layout and facilitate accurate voltage regulation at load terminals or other selected point.

1. The remote sense lines carry very little current and hence do not require a large cross-sectional area.
2. This module compensates for a maximum drop of 10% of the nominal output voltage.
3. If the unit is already trimmed up, the available remote sense compensation range should be correspondingly reduced. The total voltage increased by trim and remote sense should not exceed 10% of the nominal output voltage.
4. When using remote sense compensation, all the resistance, parasitic inductance and capacitance of the system are incorporated within the feedback loop of this module which can make an effect on the module's compensation, affecting the stability and dynamic response. A 0.1 μ F ceramic capacitor can be connected at the point of load to de-couple noise on the sense wires.
5. Recommend the connection of remote sense compensation as below figure. There are a resistor R_{S+} (30.1 ohm) from V_{o+} to Sense+ and a resistor R_{S-} (30.1 ohm) from V_{o-} to Sense- inside of this module.

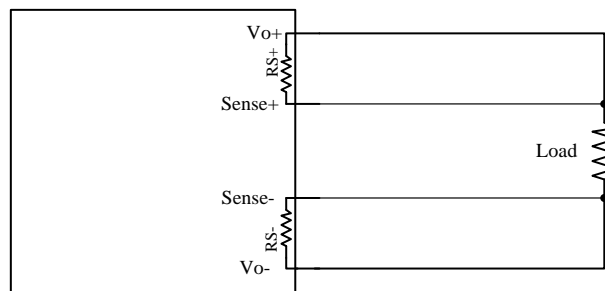

Figure 10.

6. If not using remote sense compensation, please connect sense directly to output at module's pin, that is, connect sense+ to V_{o+} and sense- to V_{o-} at module's pin, the shorter the better. see below figure.

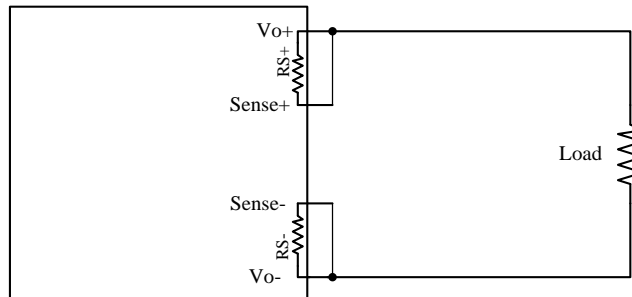

Figure 11.

9. OUTPUT TRIM EQUATIONS

Equations for calculating the trim resistor are shown below. The Trim Down resistor should be connected between the Trim pin and Sense (-) pin. The Trim Up resistor should be connected between the Trim pin and the Sense (+). Only one of the resistors should be used for any given application.

Minimum trim down voltage is 10.8 V

Maximum trim up voltage is 13.2 V.

The total voltage increased by trim and remote sense should not exceed 10% of the nominal output voltage.

Trim down test circuit

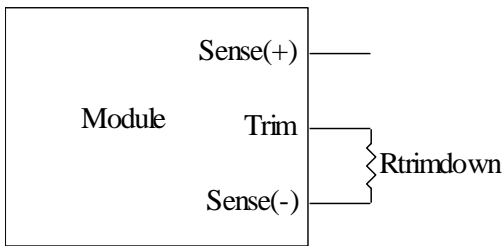

Figure 12. Trim down test circuit

$$R_{trimdown} = \frac{511}{|\delta|} - 10.22 [k\Omega]$$

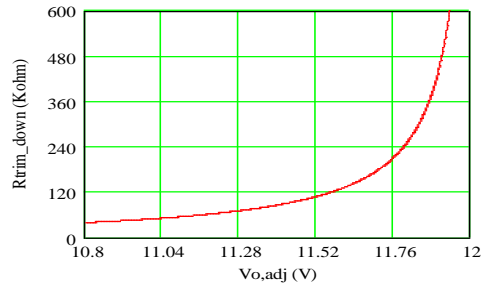

Figure 13. Trim down curve

Trim up test circuit

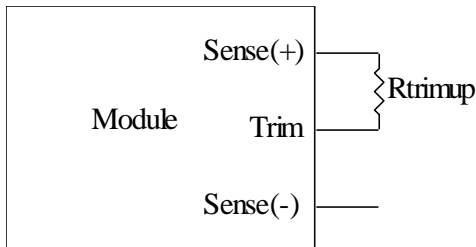

Figure 14. Trim up test circuit

$$R_{trimup} = \frac{(100 + \delta) \cdot V_o \cdot 5.11 - 626}{1.225 \cdot \delta} - 10.22 [k\Omega]$$

$$\delta = \frac{(V_{o_req} - V_o)}{V_o} \times 10 [\%]$$

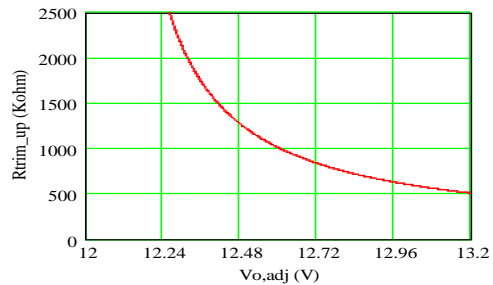

Figure 15. Trim up curve

NOTE: Output voltage $V_o = 12.036V$

V_{o_req} = Desired(trimmed) output voltage[V]

10. RIPPLE AND NOISE WAVEFORM

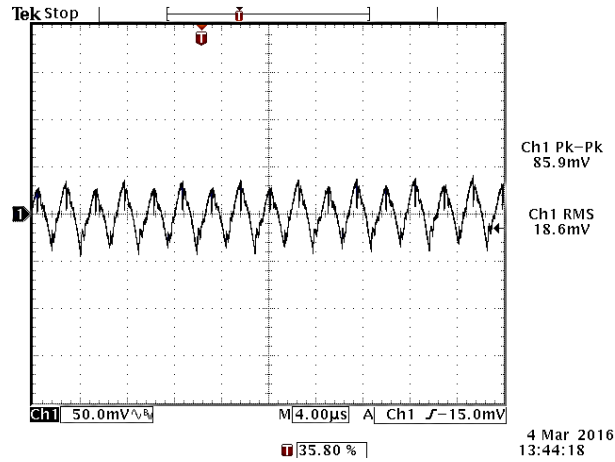

Figure 16. Ripple and noise waveform

Ripple and noise at full load, 24 VDC input, 12 VDC / 13 A output and $T_a = 25^\circ\text{C}$, and with a 1 μF ceramic cap and a 10 μF Tantalum cap and 220 μF Tantalum cap at output.

11. TRANSIENT RESPONSE WAVEFORMS

$di/dt = 0.1\text{ A}/\mu\text{s}$, a 1 μF ceramic capacitor, a 10 μF Tantalum cap and 220 μF Tantalum cap at output.

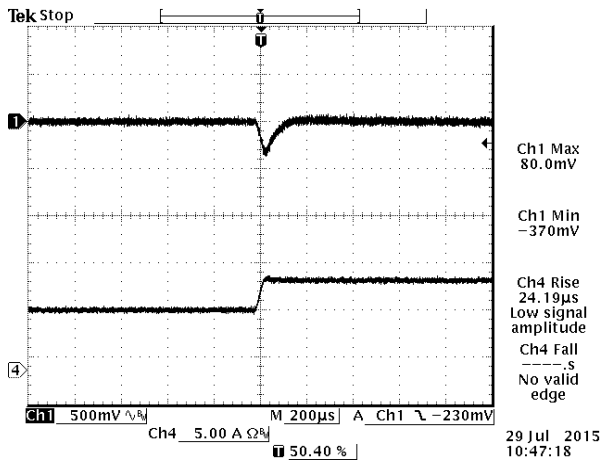

Figure 17. $V_{out} = 12\text{ V}$ 50%-75% Load Transients at $V_{in} = 24\text{ V}$ @ $T_a = 25^\circ\text{C}$
 CH1 = V_{out}
 CH4 = I_{out}

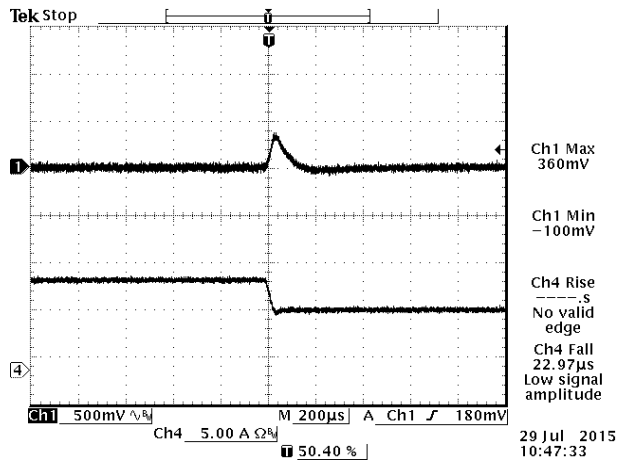

Figure 18. $V_{out} = 12\text{ V}$ 75%-50% Load Transients at $V_{in} = 24\text{ V}$ @ $T_a = 25^\circ\text{C}$
 CH1 = V_{out}
 CH4 = I_{out}

12. STARTUP & SHUTDOWN

Rise time

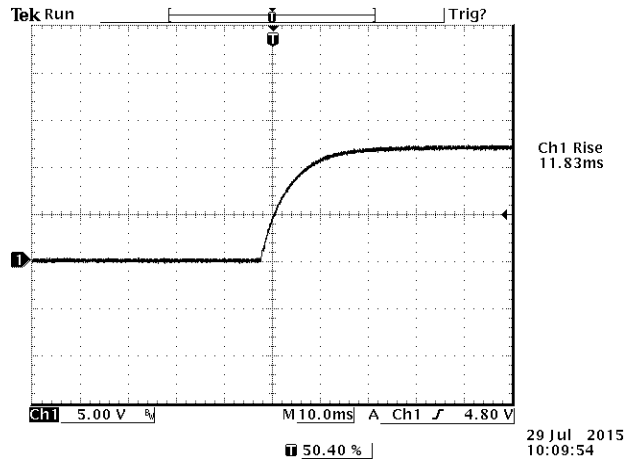

Figure 19. Rise time @ $V_{in} = 24\text{ V}$, Full Load

Startup time

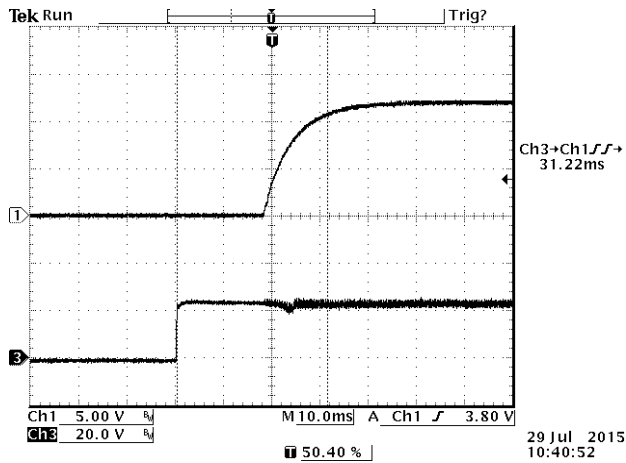

Figure 20. $V_{in} = 24\text{ V}$, Full Load
startup from V_{in}
CH1 = V_{out}
CH3 = V_{in}

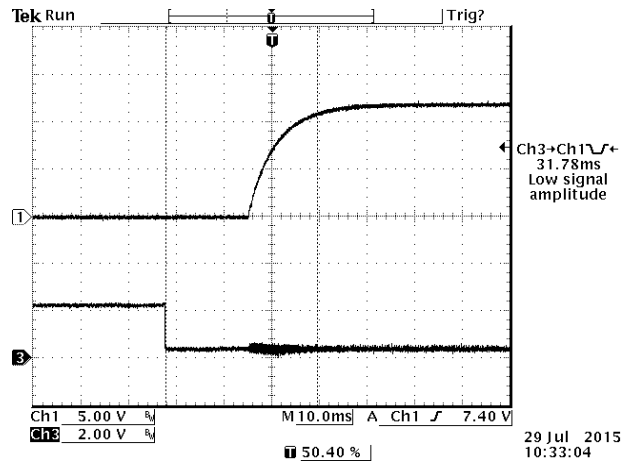

Figure 21. $V_{in} = 24\text{ V}$, Full Load
startup from Enable
CH1 = V_{out}
CH3 = Enable

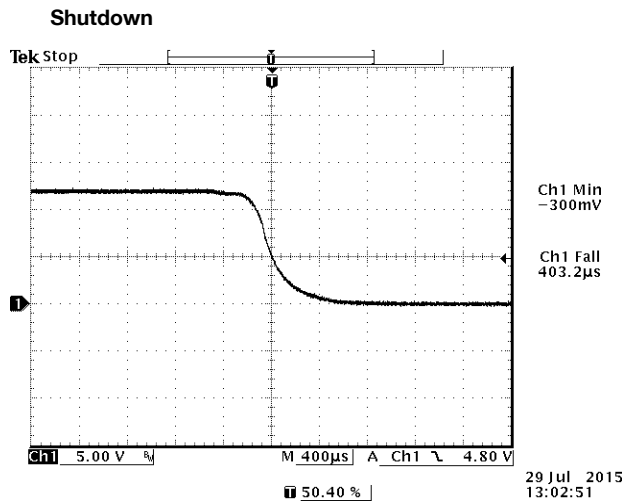

Figure 22. $V_{in} = 24\text{ V}$, Full Load shutdown from V_{in}

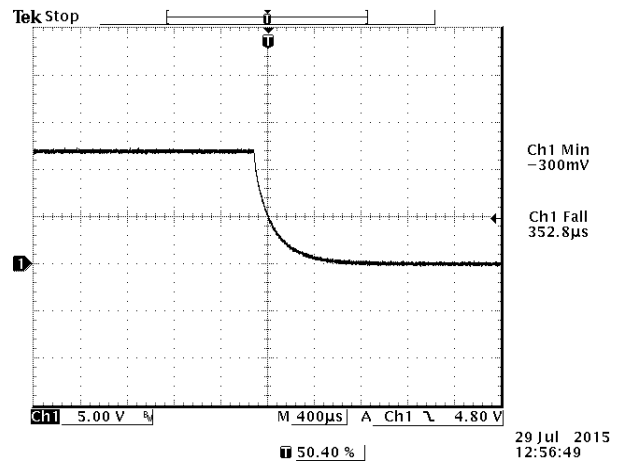

Figure 23. $V_{in} = 24\text{ V}$, Full Load shutdown from Enable

13. OVER CURRENT PROTECTION

To provide protection in a fault output over-load condition, the module is equipped with internal current-limiting circuitry which can endure current limiting for a few milliseconds. If the overcurrent condition persists beyond a few milliseconds, the module will shut down into hiccup mode and restart once every 0.8 s. The module operates normally when the output current goes into specified range. The typical average output current is 20 A during hiccup.

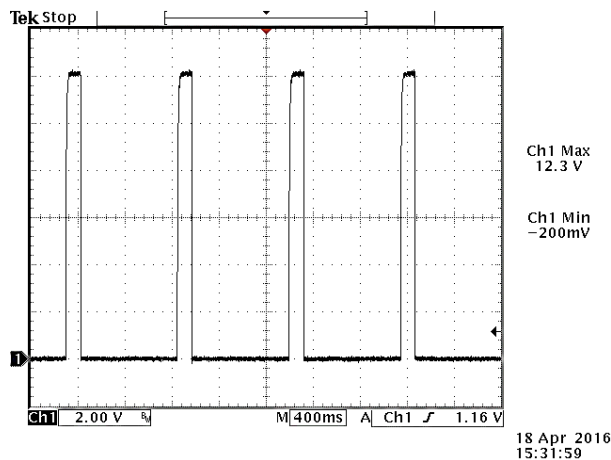

Figure 24. $V_{in} = 24\text{ V}$, I_{out} OCP

14. OUTPUT OVERVOLTAGE PROTECTION

The output over voltage protection consists of circuitry that monitors the voltage on the output terminals. If the voltage on the output terminals exceeds the over voltage protection threshold, the module will shut down into latch off mode. The over voltage latch can be reset by either cycling the input power or toggling the on/off signal for one second at least.

Test Setup:

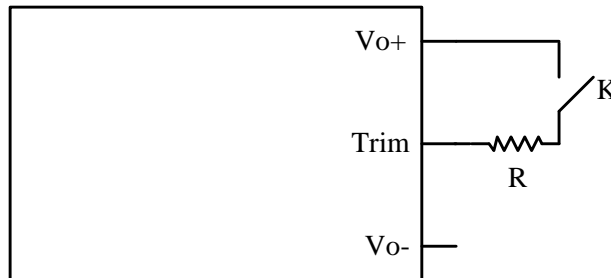

Figure 25. Test setup

$$R = 150 \text{ K}\Omega$$

15. OVER TEMPERATURE PROTECTION

The OTP is achieved by thermistor RT and the threshold is set at 120°C in non-latch mode; the hottest component (bottom side) U7 reaches 115 °C or the base plate (top side) reaches 110°C with 200 LFM air flow correspondingly. It will restart automatically when the temperature falls down to 110°C. The protecting point will be varied a little under different conditions (air flow, ambient temperature, input voltage, load...).

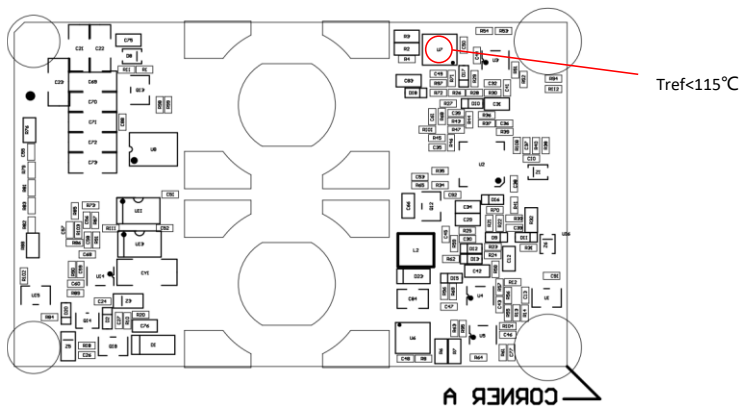

Figure 26. Temperature reference points on bottom side

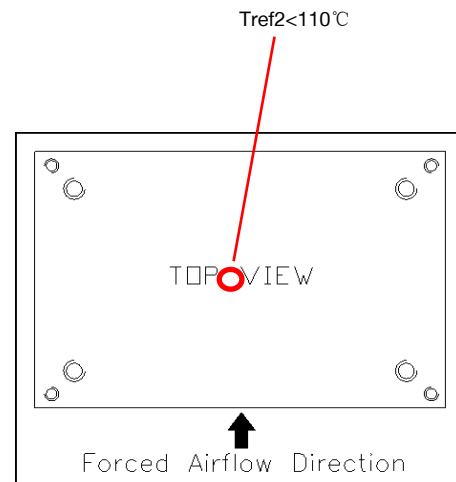

Figure 27. Temperature reference points on top side

16. INPUT UNDER-VOLTAGE LOCKOUT

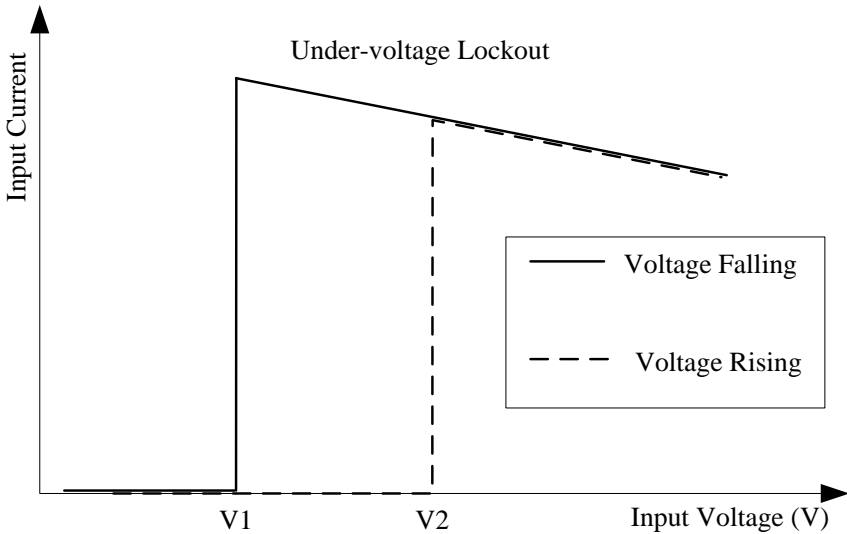
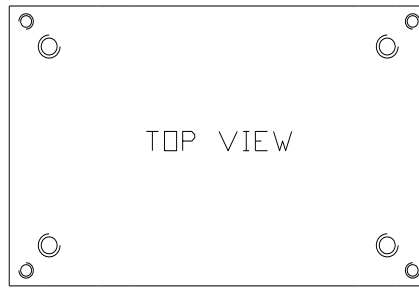

Figure 28. Input under-voltage lockout
V1 = 8 V
V2 = 10 V

17. THERMAL DERATING CURVE



↑
Forced Airflow Direction

Figure 29. Airflow direction

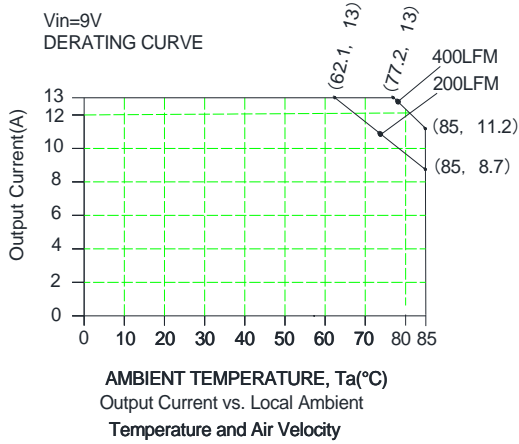

Figure 30. Derating curve @ Vin = 9 V

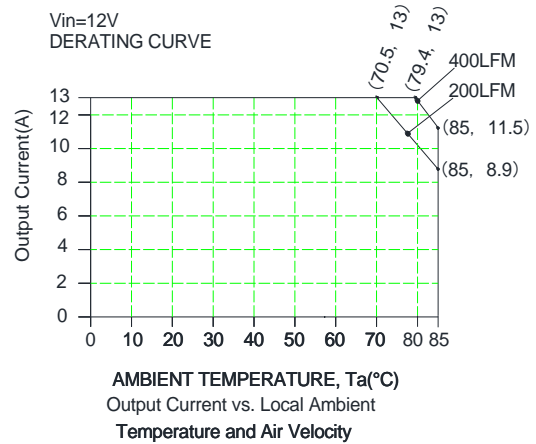

Figure 31. Derating curve @ Vin = 12 V

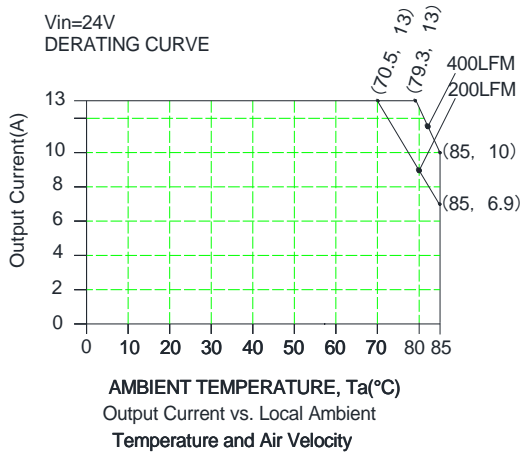

Figure 32. Derating curve @ Vin = 24 V

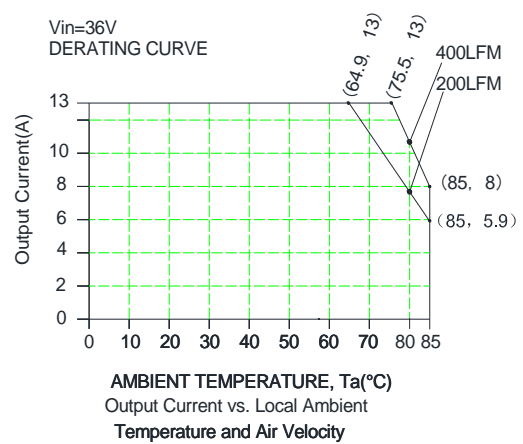

Figure 33. Derating curve @ Vin = 36 V

18. SAFETY & EMC

SAFETY: (Except 0RQB-C2Q12V)

- 1. Material flammability UL94V-0
- 2. Nemko certification EN 62368-1
- 3. CSA certification CSA/UL 62368-1
- 4. CB certification IEC/EN 62368-1

EMC:

- 1. Conductive EMI: EN 55032 class B
Compliance to EN 55032 class B (both peak and average) with the following inductive and capacitive filter.

SETUP:

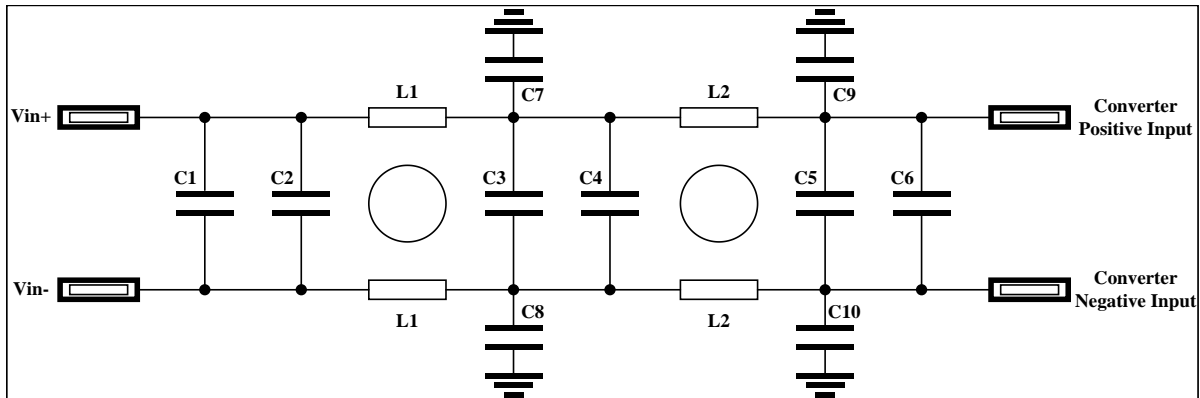

Figure 34.

ITEM	DESIGNATION	PARAMETER	VENDOR	VENDOR P/N
1	C1	Chip CAP X7R 4.7µF +/-10% 50V 1210	MURATA	GRM32ER71H475KA88L
2	C2	Chip CAP X7R 4.7µF +/-10% 50V 1210	MURATA	GRM32ER71H475KA88L
3	C3	NOT USED		
4	C4	NOT USED		
5	C5	100µF/100V 105 10*20	Nichicon	UVZ2A101MPD
6	C6	100µF/100V 105 10*20	Nichicon	UVZ2A101MPD
7	C7	EMI Suppression Cap Y2 MKP 33nF+/-20% 300VAC	EPCOS	B32022A3333M289
8	C8	EMI Suppression Cap Y2 MKP 33nF+/-20% 300VAC	EPCOS	B32022A3333M289
9	C9	EMI Suppression Cap Y2 MKP 33nF+/-20% 300VAC	EPCOS	B32022A3333M289
10	C10	EMI Suppression Cap Y2 MKP 33nF+/-20% 300VAC	EPCOS	B32022A3333M289
11	L1	1.47mH/30A	core: Laird	core: 40T0984-00H
12	L2	320µH/30A	core: Laird	core: 40T0711-00H

Positive:

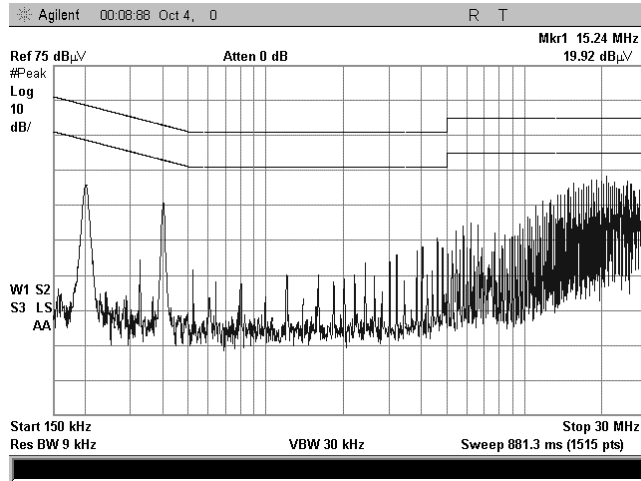

Figure 35.

Negative:

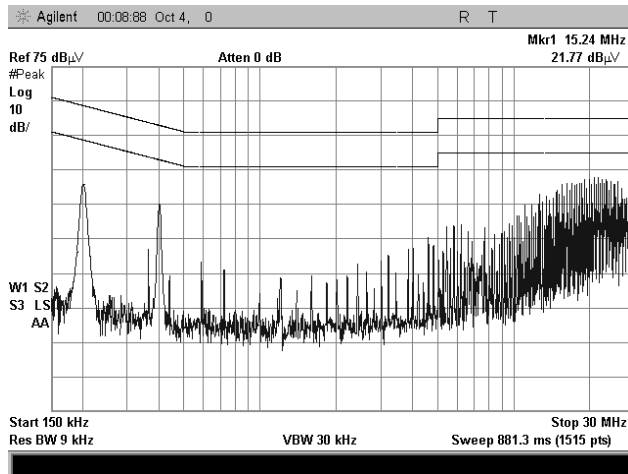

Figure 36.

19. MECHANICAL DIMENSIONS

OUTLINE (0RQB-C2Q120 & 0RQB-C2Q12L)

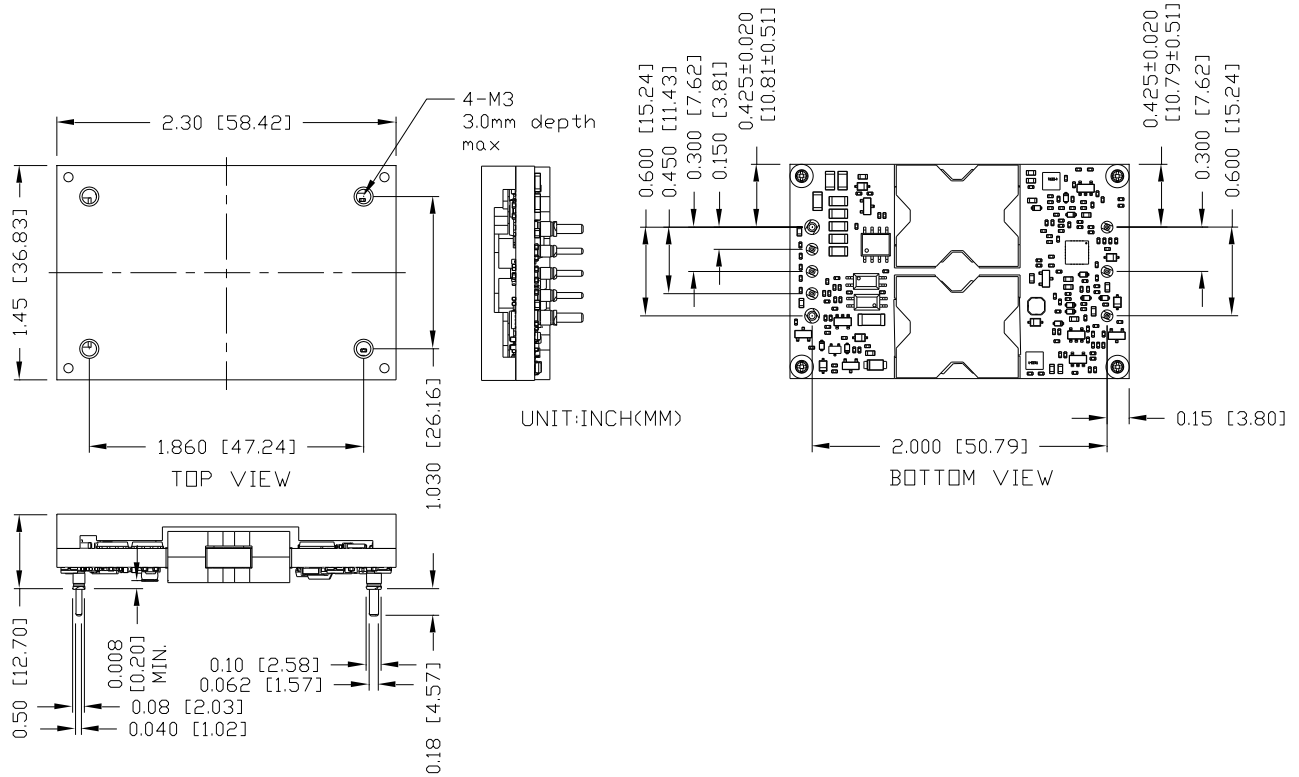

Figure 37. 0RQB-C2Q120 & 0RQB-C2Q12L Outline

NOTE: This module is recommended and compatible with Pb-Free Wave Soldering and must be soldered using a peak solder temperature of no more than 260 °C for less than 5 seconds.

NOTES:

- 1) All Pins: Material - Copper Alloy;
Finish – 3 micro inches minimum Gold over 50 micro inches minimum Nickel plate.
- 2) Un-dimensioned components are shown for visual reference only.
- 3) All dimensions in inches; Tolerances: x.xx +/-0.02 in [0.51 mm]. x.xxx +/-0.010 in [0.25 mm].

OUTLINE (0RQB-C2Q12V)

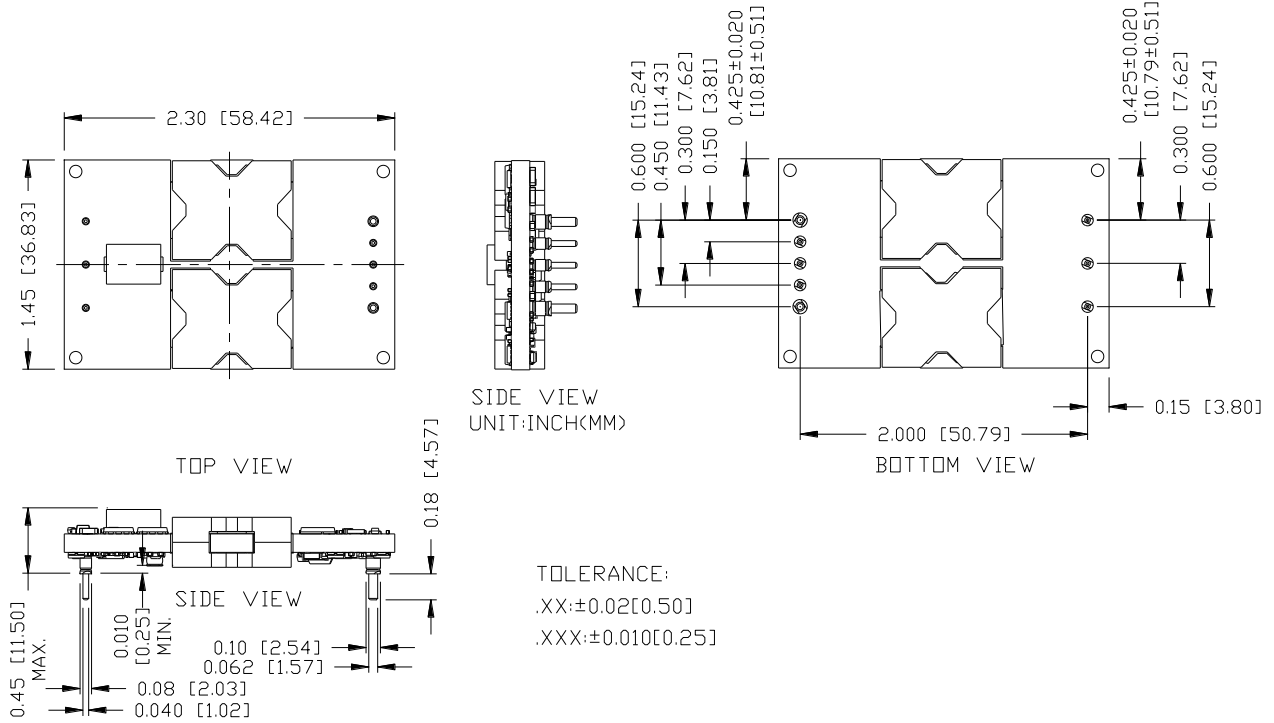

Figure 38. 0RQB-C2Q12V Outline

NOTE: This module is recommended and compatible with Pb-Free Wave Soldering and must be soldered using a peak solder temperature of no more than 260 °C for less than 5 seconds.

NOTES:

- 1) All Pins: Material - Copper Alloy;
Finish – 3 micro inches minimum Gold over 50 micro inches minimum Nickel plate.
- 2) Un-dimensioned components are shown for visual reference only.
- 3) All dimensions in inches; Tolerances: x.xx +/-0.02 in [0.51 mm]. x.xxx +/-0.010 in [0.25 mm].

PIN DEFINITIONS

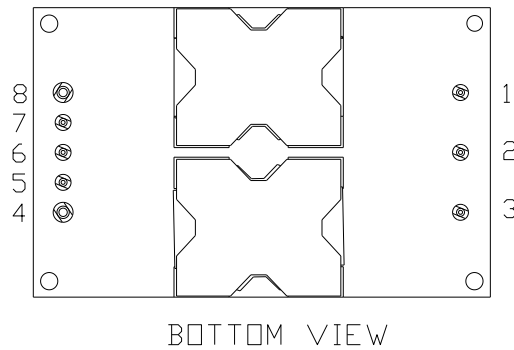

Figure 39. Pins

PIN	FUNCTION	PIN SIZE	PIN	FUNCTION	PIN SIZE
1	Vin+	0.040"	5	Sense-	0.040"
2	On/Off	0.040"	6	Trim	0.040"
3	Vin-	0.040"	7	Sense+	0.040"
4	Vout-	0.060"	8	Vout+	0.060"

RECOMMENDED PAD LAYOUT

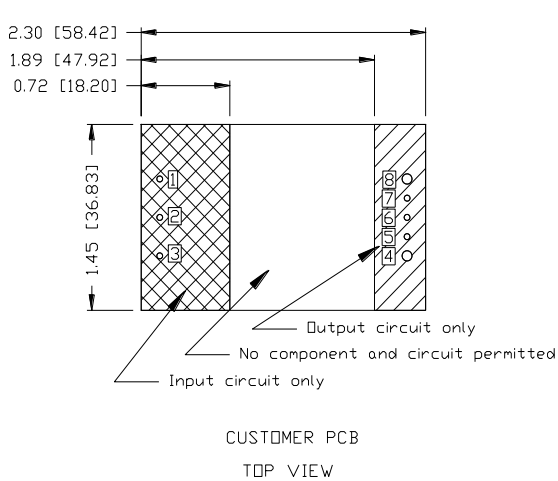

Figure 40. Recommended pad layout-1

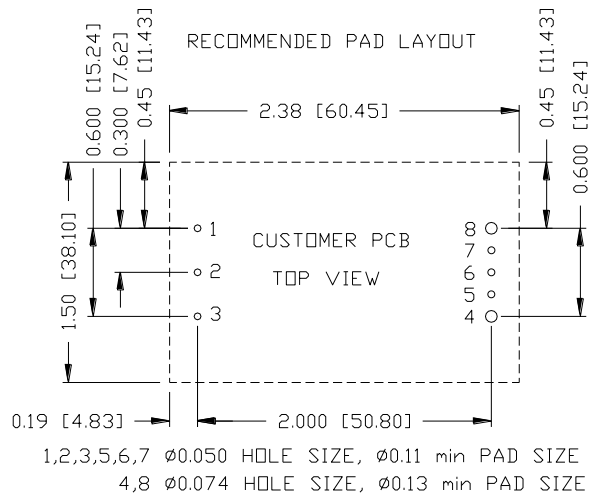

Figure 41. Recommended pad layout-2

20. SCHEMATIC DIAGRAM

Fundamental circuit diagram

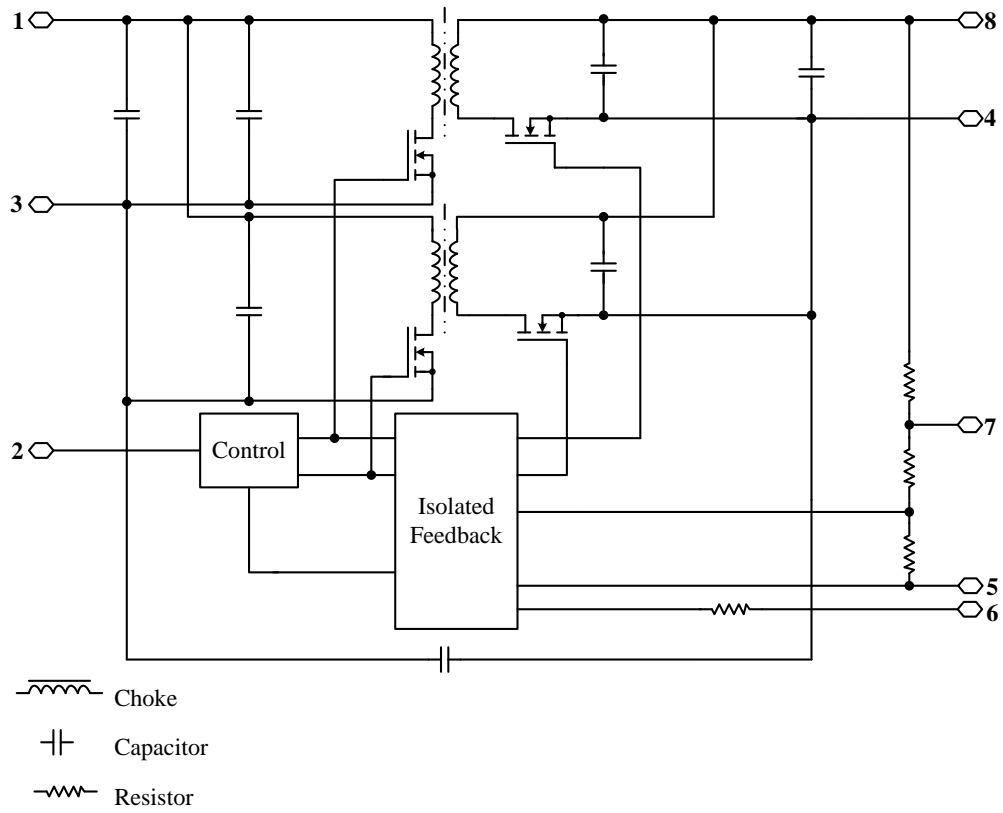

Figure 42.

21. REVISION HISTORY

DATE	REVISION	CHANGES DETAIL	APPROVAL
2013-04-26	A	First revision	XF.Jiang
2016-04-28	B	Update the remote off input current, output ripple and noise(pk-pk), output DC current limit, rise time, output capacitance, transient response settling time, efficiency, switching frequency, isolation capacitance, add efficiency data and layout, add the wave of NR, TR, startup & shutdown, OCP, MD, safety & EMC.	XF.Jiang
2016-06-27	C	Update altitude, load regulation, output current range, output capacitance, FIT, weigh, TD, OTP, add the relative humidity range.	XF.Jiang
2016-10-11	AD	Add temperature reference points on top side.	XF.Jiang
2017-04-13	AE	Update TD.	XF.Jiang
2017-10-18	AF	Update Input withstand Voltage.	J.Yao
2018-05-08	AG	Update Part number explanation.	J.Yao
2020-03-25	AH	Update TD. Add input OVLO turn-on and turn-off voltage threshold.	XF.Jiang
2020-05-07	AI	Add safety certificate	F.Tao
2020-07-14	AJ	Add open frame version:0RQB-C2Q12V	XF.Jiang
2021-04-21	AK	Add pre-bias voltage, object ID and recommended pad layout.	DW.Ren

For more information on these products consult: tech.support@psbel.com

NUCLEAR AND MEDICAL APPLICATIONS - Products are not designed or intended for use as critical components in life support systems, equipment used in hazardous environments, or nuclear control systems.

TECHNICAL REVISIONS - The appearance of products, including safety agency certifications pictured on labels, may change depending on the date manufactured. Specifications are subject to change without notice.



Asia-Pacific
+86 755 298 85888

Europe, Middle East
+353 61 225 977

North America
+1 408 785 5200