

**PowerCool Series Thermoelectric Cooler Assembly**

The AA-040-12-22 is an Air-to-Air Thermoelectric Cooler Assembly that uses impingement flow to transfer heat. It offers dependable, compact performance by cooling objects via convection. Heat is absorbed and dissipated through high density heat exchangers equipped with air ducted shrouds and brand name fans. The heat pumping action is created by thermoelectric modules, which are custom designed to achieve a high coefficient of performance (COP). It has a maximum Qc of 41 Watts when  $\Delta T = 0$  and a maximum  $\Delta T$  of 43 °C at Qc = 0.



**Features**

- Compact design
- Precise temperature control
- Reliable solid-state operation
- Low noise
- RoHS-compliant

**Applications**

- Medical Diagnostic and Analytical Instrumentation
- Thermoelectric Coolers and Assemblies for Medical Applications
- Liquid Cooling Options for PET and SPECT Scanners
- Cooling for Centrifuges
- High-Performance Liquid Chromatography (HPLC)
- Heating and Cooling for Liquid Chromatography Systems

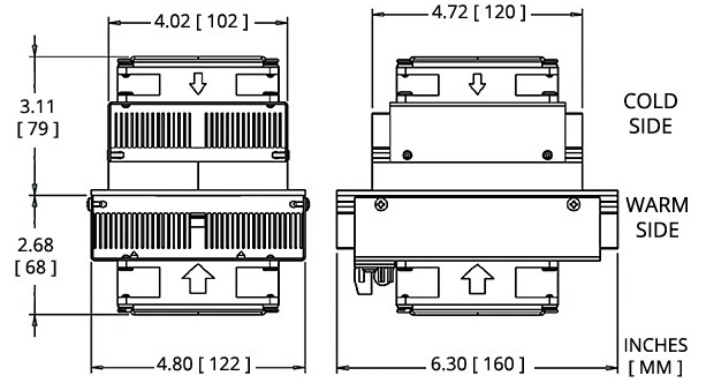

**ELECTRICAL AND THERMAL PERFORMANCE**

Heat Pumped at Cold Side (Qc)  
 Tambient = 35°C | Tcontrol = 20°C

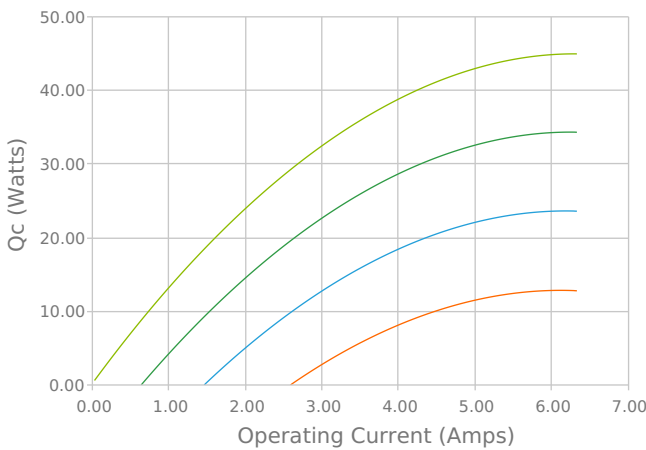

Heat Pumped at Cold Side (Qc)  
 Tambient = 35°C | Tcontrol = 20°C

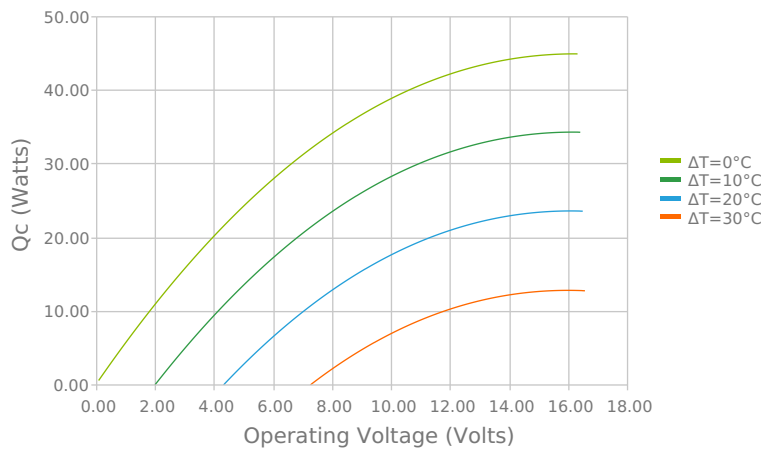

Coefficient of Performance (COP = Qc/Pin)  
 Tambient = 35°C | Tcontrol = 20°C

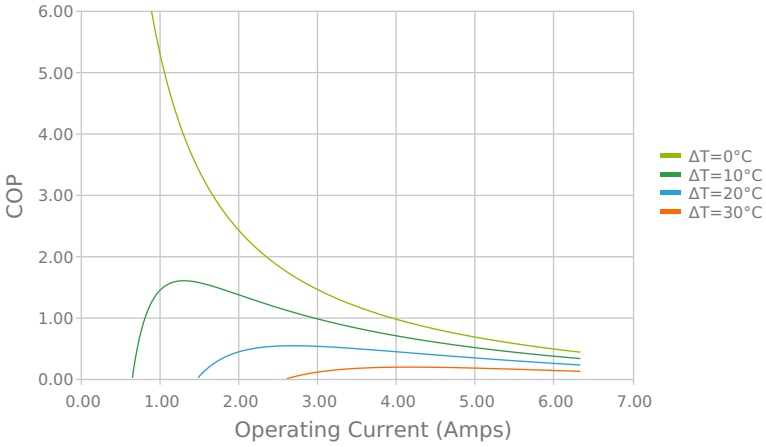

Coefficient of Performance (COP = Qc/Pin)  
 Tambient = 35°C | Tcontrol = 20°C

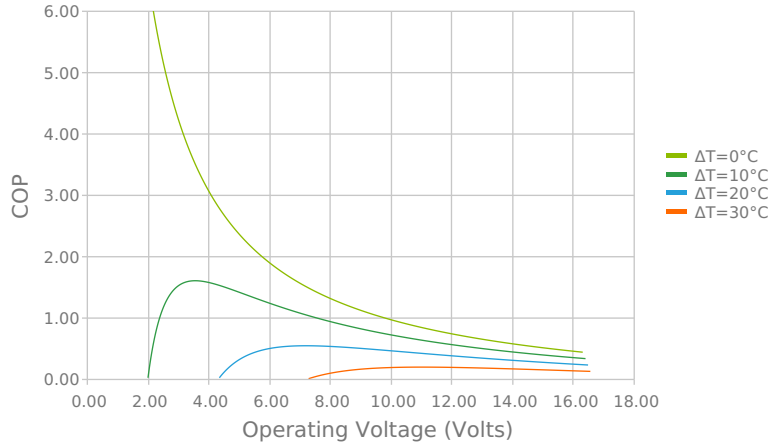

Total Heat Dissipated at Hot Side (Qh=Qc+Pin)  
 Tambient = 35°C | Tcontrol = 20°C

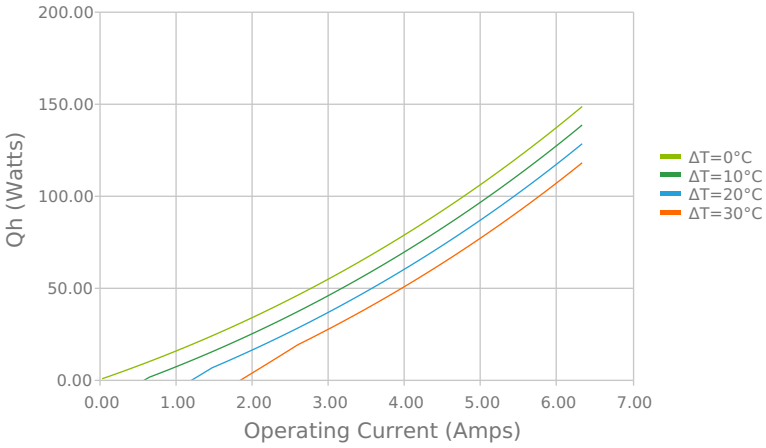

Total Heat Dissipated at Hot Side (Qh=Qc+Pin)  
 Tambient = 35°C | Tcontrol = 20°C

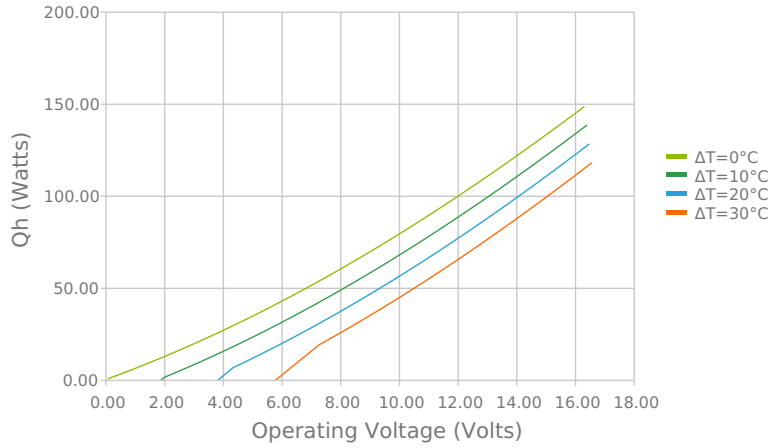

Heat Pumped at Cold Side (Qc)  
 Voperating = 12.02 Volts | Ioperating = 4.79 Amps

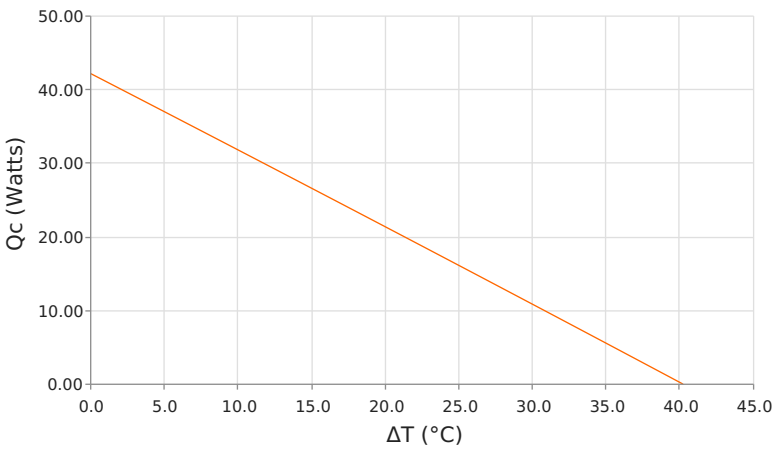

Coefficient of Performance (COP = Qc/Pin)  
 Voperating = 12.02 Volts | Ioperating = 4.79 Amps

