

High Luminous Efficacy
RGBA LED Emitter

LZC-03MA07

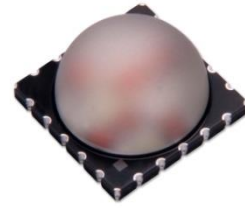

Key Features

- Ultra-bright, Ultra-compact 40W RGBA LED
- Individually addressable Red, Green, Blue and Amber channels
- Small high density foot print – 9.0mm x 9.0mm
- Surface mount ceramic package with integrated glass lens
- Exceptionally low Thermal Resistance (0.7°C/W)
- Electrically neutral thermal path
- Extreme Luminous Flux density
- JEDEC Level 1 for Moisture Sensitivity Level
- Lead (Pb) free and RoHS compliant
- Reflow solderable (up to 6 cycles)
- Emitter available on 4-channel MCPCB (optional)
- Recommended use with LLxx-3T08 family of High Efficiency / High Uniformity color-mixing lenses for perfect color uniformity from 8 to 32 deg.

Typical Applications

- Architectural lighting
- Entertainment
- Stage and Studio lighting
- Accent lighting

Description

The LZC-03MA07 RGBA LED emitter enables a full spectrum of brilliant colors with the highest light output, highest flux density, and superior color mixing available. It outperforms other colored lighting solutions with multiple red, green, blue and amber LED die in a single, compact emitter. With 40W power capability and a 9.0mm x 9.0mm ultra-small footprint, this package provides exceptional luminous flux density. LED Engin's RGBA LED offers ultimate design flexibility with four individually addressable color channels. The patented design with thermally and electrically isolated pads has unparalleled thermal and optical performance. The high quality materials used in the package are chosen to optimize light output and minimize stresses which results in monumental reliability and lumen maintenance. The robust product design thrives in outdoor applications with high ambient temperatures and high humidity.

Part Number Options

Base part number

Part number	Description
LZC-03MA07-xxxx	LZC emitter
LZC-B3MA07-xxxx	LZC emitter on 4 channel 4x3 Star MCPCB

Bin kit option codes

MA, Red-Green-Blue-Amber (RGBA)			
Kit number suffix	Min flux Bin	Color Bin Range	Description
0000	11R	R2 – R2	Red, full distribution flux; full distribution wavelength
	14G	G2 – G3	Green, full distribution flux; full distribution wavelength
	03B	B03 – B03	Blue, full distribution flux; full distribution wavelength
	11A	A9 – A9	Amber, full distribution flux; full distribution wavelength

Notes:

1. Default bin kit option is -0000

Luminous Flux Bins

Table 1:

Bin Code	Minimum Luminous Flux (Φ_v) @ $I_F = 700\text{mA}$ ^[1,2] (lm)				Maximum Luminous Flux (Φ_v) @ $I_F = 700\text{mA}$ ^[1,2] (lm)			
	3 Red	3 Green	3 Blue	3 Amber	3 Red	3 Green	3 Blue	3 Amber
	11R	260				420		
14G		300				480		
03B			48				77	
04B			77				130	
11A				240				400

Notes for Table 1:

- Luminous flux performance guaranteed within published operating conditions. LED Engin maintains a tolerance of $\pm 10\%$ on flux measurements.
- Each flux value consists of 3 dies from the same color in series for binning purposes.

Dominant Wavelength Bins

Table 2:

Bin Code	Minimum Dominant Wavelength (λ_D) @ $I_F = 700\text{mA}$ ^[1,2] (nm)				Maximum Dominant Wavelength (λ_D) @ $I_F = 700\text{mA}$ ^[1,2] (nm)			
	Red	Green ^[2]	Blue	Amber	Red	Green ^[2]	Blue	Amber
	R2	618				630		
G2		520				525		
G3		525				530		
B03			453				460	
A9				590				595

Notes for Table 2:

- LED Engin maintains a tolerance of $\pm 0.5\text{nm}$ on dominant wavelength measurements.

Forward Voltage Bin

Table 3:

Bin Code	Minimum Forward Voltage (V_F) @ $I_F = 700\text{mA}$ ^[1] (V)				Maximum Forward Voltage (V_F) @ $I_F = 700\text{mA}$ ^[1] (V)			
	Red	Green	Blue	Amber	Red	Green	Blue	Amber
	0	6.00	9.30	9.30	6.00	8.00	12.00	12.00

Notes for Table 3:

- Forward Voltage is binned with all three LED dice connected in series.
- LED Engin maintains a tolerance of $\pm 0.12\text{V}$ for forward voltage measurements for the three LEDs.

Absolute Maximum Ratings

Table 4:

Parameter	Symbol	Value	Unit
DC Forward Current ^[1]	I_F	1000	mA
Peak Pulsed Forward Current ^[2]	I_{FP}	1500	mA
Reverse Voltage	V_R	See Note 3	V
Storage Temperature	T_{stg}	-40 ~ +150	°C
Junction Temperature [Blue, Green]	T_J	150	°C
Junction Temperature [Red, Amber]	T_J	125	°C
Soldering Temperature ^[4]	T_{sol}	260	°C
Allowable Reflow Cycles		6	
ESD Sensitivity ^[5]		> 8,000 V HBM Class 3B JESD22-A114-D	

Notes for Table 4:

- Maximum DC forward current is determined by the overall thermal resistance and ambient temperature. Follow the curves in Figure 12 for current derating.
- Pulse forward current conditions: Pulse Width ≤ 10msec and Duty Cycle ≤ 10%.
- LEDs are not designed to be reverse biased.
- Solder conditions per JEDEC 020D. See Reflow Soldering Profile Figure 5.
- LED Engin recommends taking reasonable precautions towards possible ESD damages and handling the LZC-03MA07 in an electrostatic protected area (EPA). An EPA may be adequately protected by ESD controls as outlined in ANSI/ESD S6.1.

Optical Characteristics @ $T_C = 25^\circ\text{C}$

Table 5:

Parameter	Symbol	Typical				Unit
		Red	Green	Blue ^[1]	Amber	
Luminous Flux (@ $I_F = 700\text{mA}$)	Φ_V	340	430	100	320	lm
Luminous Flux (@ $I_F = 1000\text{mA}$)	Φ_V	475	560	130	410	lm
Dominant Wavelength	λ_D	623	523	460	590	nm
Viewing Angle ^[2]	$2\theta_{1/2}$	95				Degrees
Total Included Angle ^[3]	$\theta_{0.9}$	115				Degrees

Notes for Table 5:

- When operating the Blue LED, observe IEC 60825-1 class 2 rating. Do not stare into the beam.
- Viewing Angle is the off axis angle from emitter centerline where the luminous intensity is 1/2 of the peak value.
- Total Included Angle is the total angle that includes 90% of the total luminous flux.

Electrical Characteristics @ $T_C = 25^\circ\text{C}$

Table 6:

Parameter	Symbol	Typical				Unit
		3 Red	3 Green	3 Blue	3 Amber	
Forward Voltage (@ $I_F = 700\text{mA}$) ^[1]	V_F	7.5	10.8	9.6	7.2	V
Forward Voltage (@ $I_F = 1000\text{mA}$) ^[1]	V_F	8.1	11.2	10.0	7.8	V
Temperature Coefficient of Forward Voltage	$\Delta V_F / \Delta T_J$	-5.7	-8.7	-9.0	-5.7	mV/°C
Thermal Resistance (Junction to Case)	$R\theta_{J-C}$	0.7				°C/W

Notes for Table 6:

- Forward Voltage typical value is for three LED dice from the same color dice connected in series.

IPC/JEDEC Moisture Sensitivity Level

Table 7 - IPC/JEDEC J-STD-20D.1 MSL Classification:

Level	Soak Requirements					
	Floor Life		Standard		Accelerated	
	Time	Conditions	Time (hrs)	Conditions	Time (hrs)	Conditions
1	Unlimited	≤ 30°C/ 85% RH	168 +5/-0	85°C/ 85% RH	n/a	n/a

Notes for Table 7:

1. The standard soak time includes a default value of 24 hours for semiconductor manufacturer's exposure time (MET) between bake and bag and includes the maximum time allowed out of the bag at the distributor's facility.

Average Lumen Maintenance Projections

Lumen maintenance generally describes the ability of a lamp to retain its output over time. The useful lifetime for solid state lighting devices (Power LEDs) is also defined as Lumen Maintenance, with the percentage of the original light output remaining at a defined time period.

Based on long-term WHTOL testing, LED Engin projects that the LZ Series will deliver, on average, 70% Lumen Maintenance at 65,000 hours of operation at a forward current of 700 mA. This projection is based on constant current operation with junction temperature maintained at or below 125°C.

Recommended Solder Mask Layout (mm)

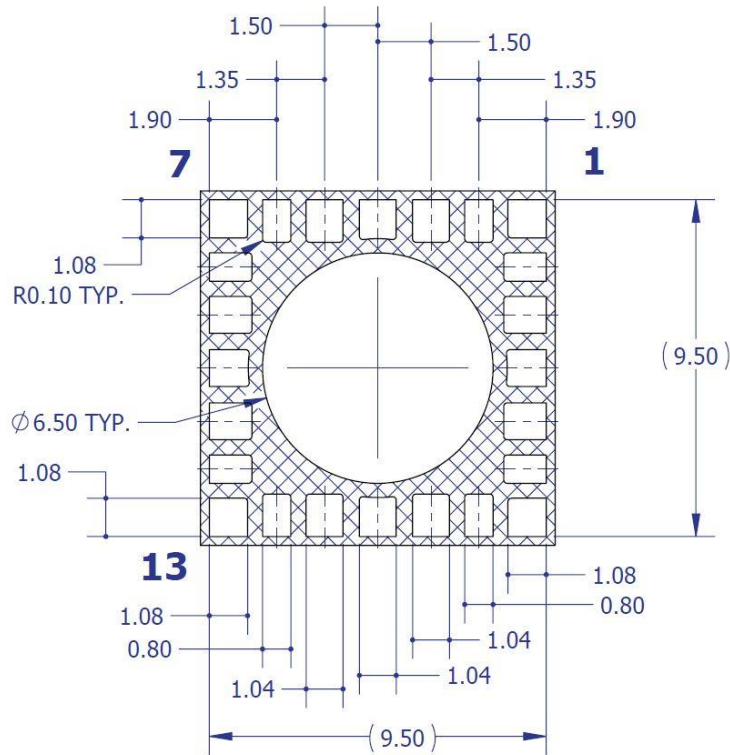

Figure 2b: Recommended solder mask opening (hatched area) for anode, cathode, and thermal pad.

Note for Figure 2b:

1. Unless otherwise noted, the tolerance = ± 0.20 mm.

Reflow Soldering Profile

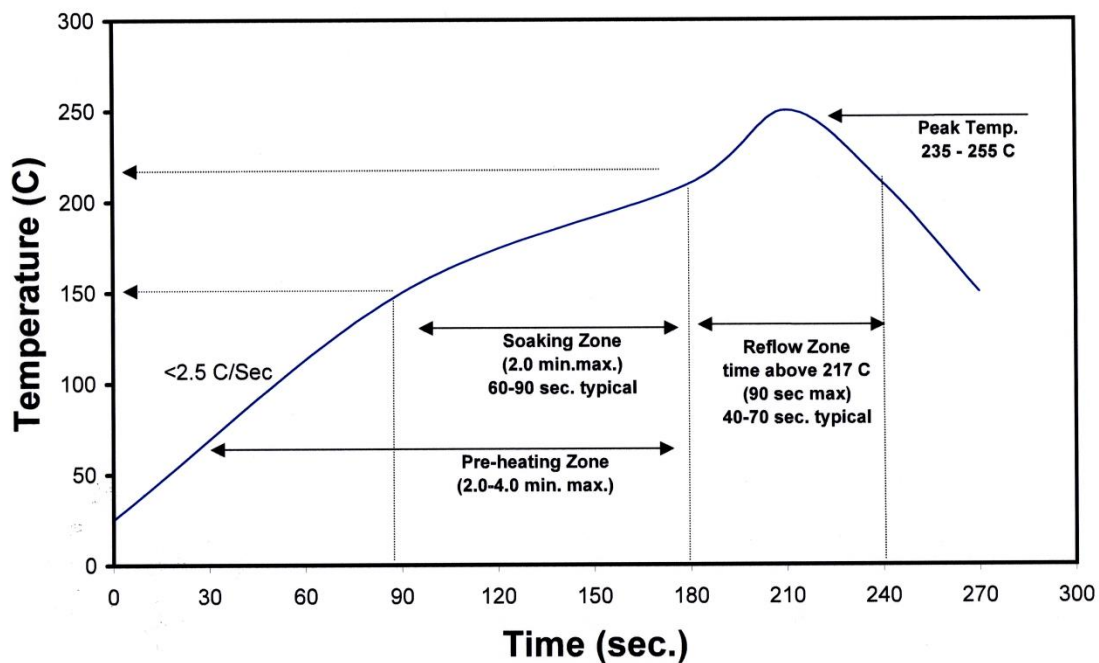

Figure 3: Reflow soldering profile for lead free soldering.

Typical Radiation Pattern

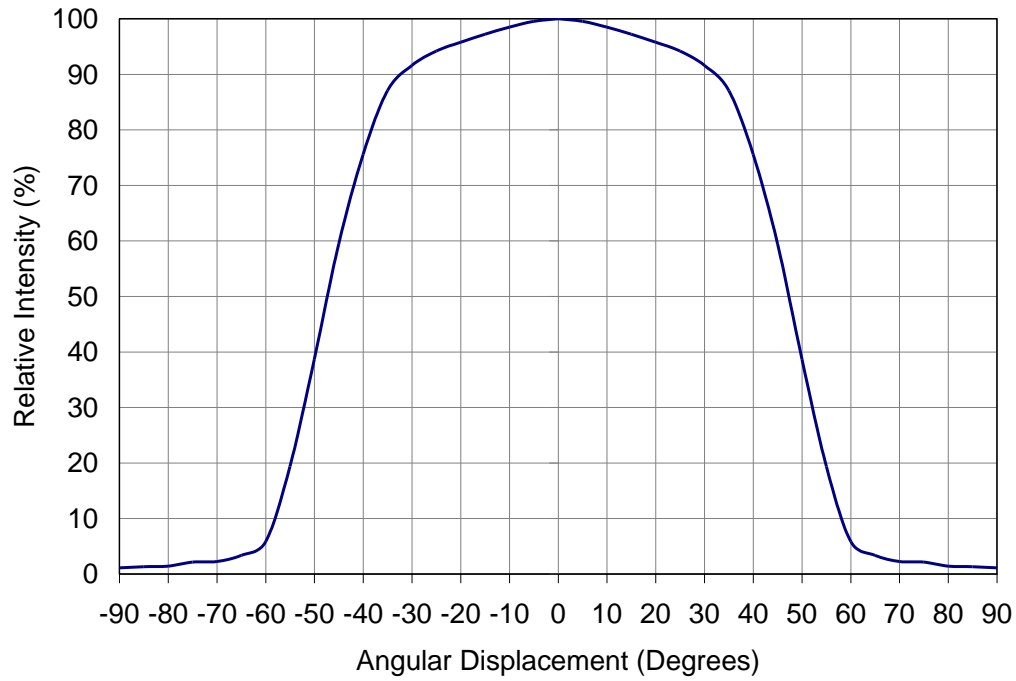

Figure 4: Typical representative spatial radiation pattern.

Typical Relative Spectral Power Distribution

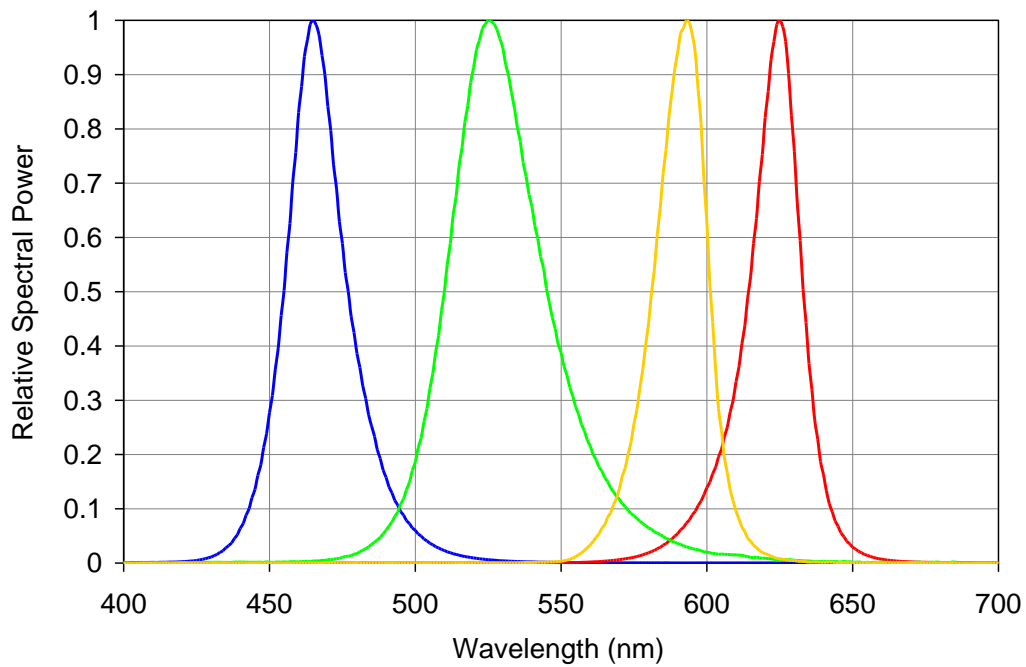

Figure 5: Typical relative spectral power vs. wavelength @ $T_c = 25^\circ\text{C}$.

Typical Dominant Wavelength Shift over Forward Current

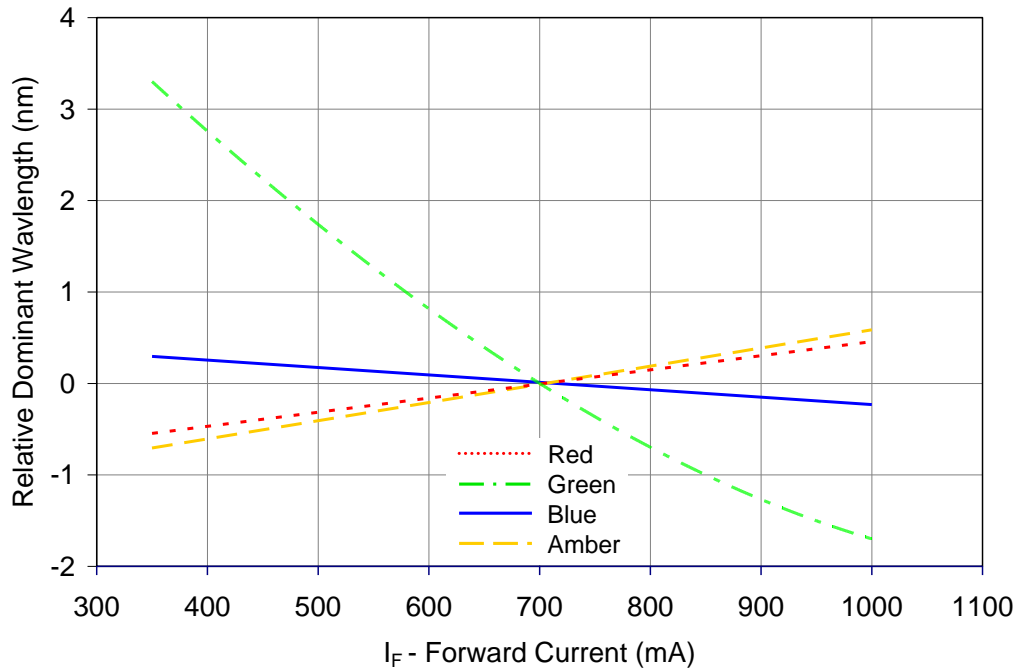

Figure 6: Typical dominant wavelength shift vs. forward current @ $T_c = 25^\circ\text{C}$.

Dominant Wavelength Shift over Temperature

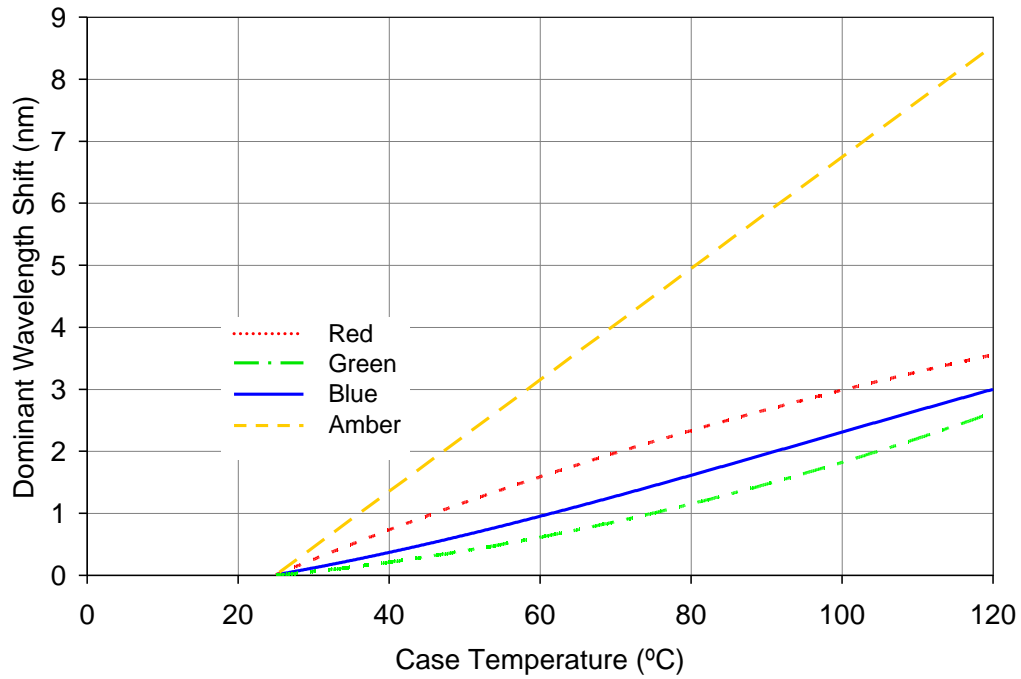

Figure 7: Typical dominant wavelength shift vs. case temperature.

Typical Relative Light Output

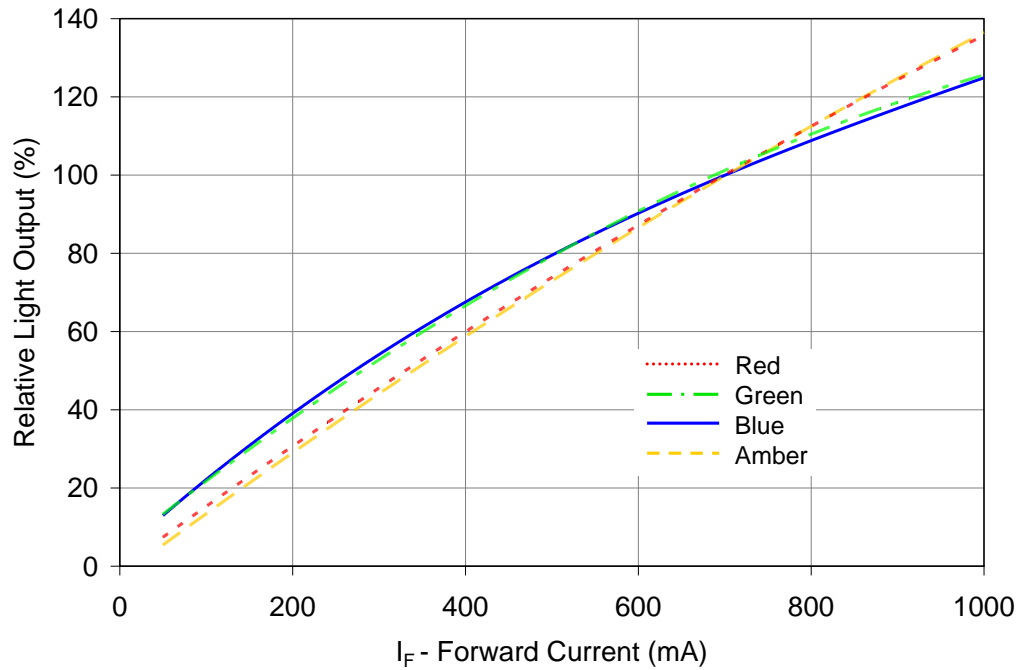

Figure 8: Typical relative light output vs. forward current @ T_c = 25°C.

Typical Relative Light Output over Temperature

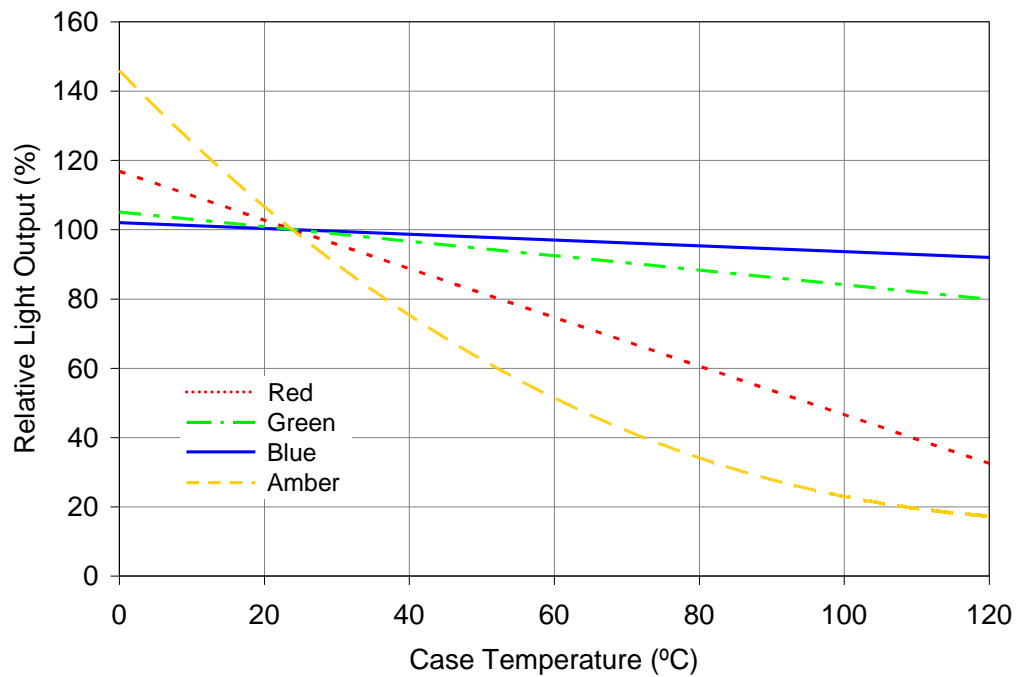

Figure 9: Typical relative light output vs. case temperature.

Typical Forward Current Characteristics

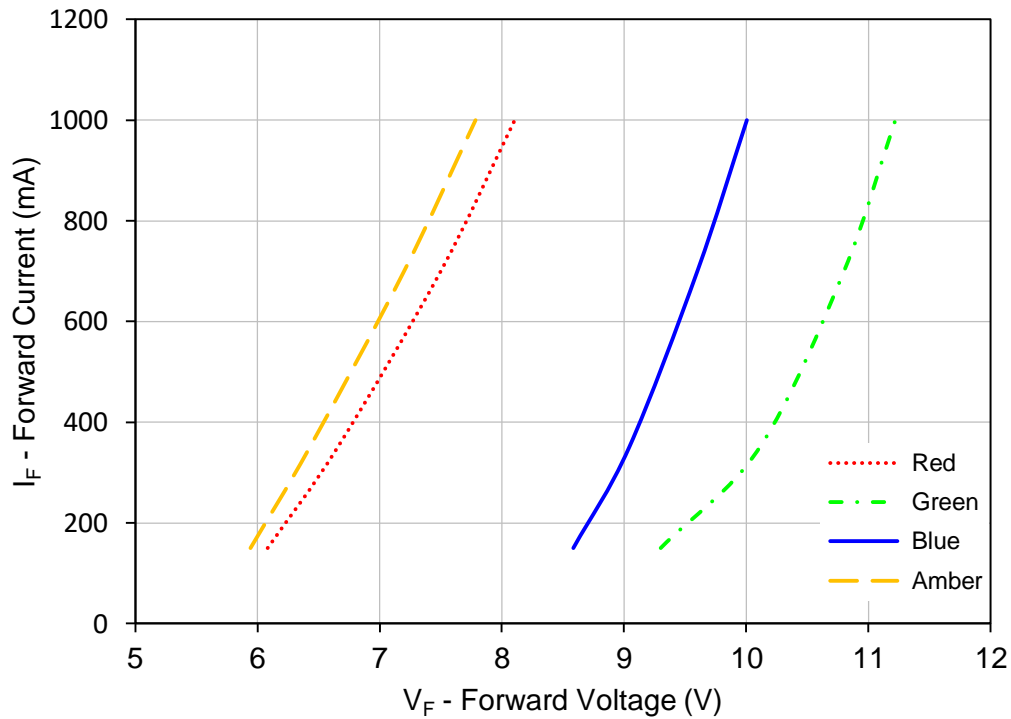

Figure 10: Typical forward current vs. forward voltage @ $T_c = 25^\circ\text{C}$.

Current De-rating

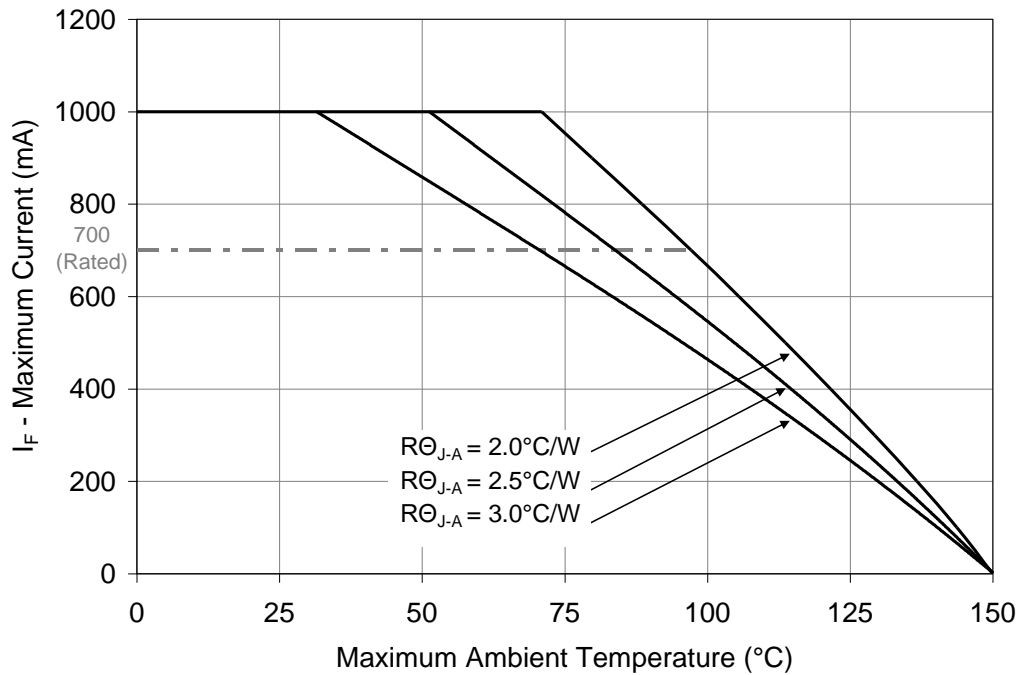

Figure 11: Maximum forward current vs. ambient temperature based on $T_{j(\text{MAX})} = 150^\circ\text{C}$.

Notes for Figure 11:

1. Maximum current assumes that all 12 LED dice are operating concurrently at the same current.
2. $R\theta_{J-C}$ [Junction to Case Thermal Resistance] for the LZC-03MA07 is typically $<0.7^\circ\text{C/W}$.
3. $R\theta_{J-A}$ [Junction to Ambient Thermal Resistance] = $R\theta_{J-C} + R\theta_{C-A}$ [Case to Ambient Thermal Resistance].

Emitter Tape and Reel Specifications (mm)

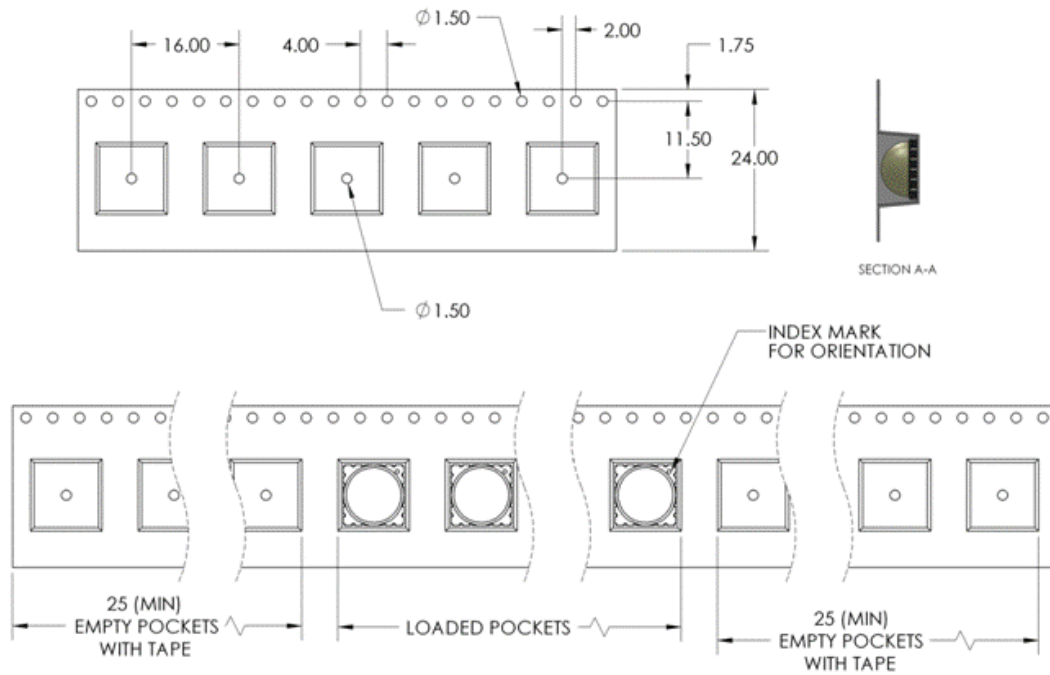

Figure 12: Emitter carrier tape specifications (mm).

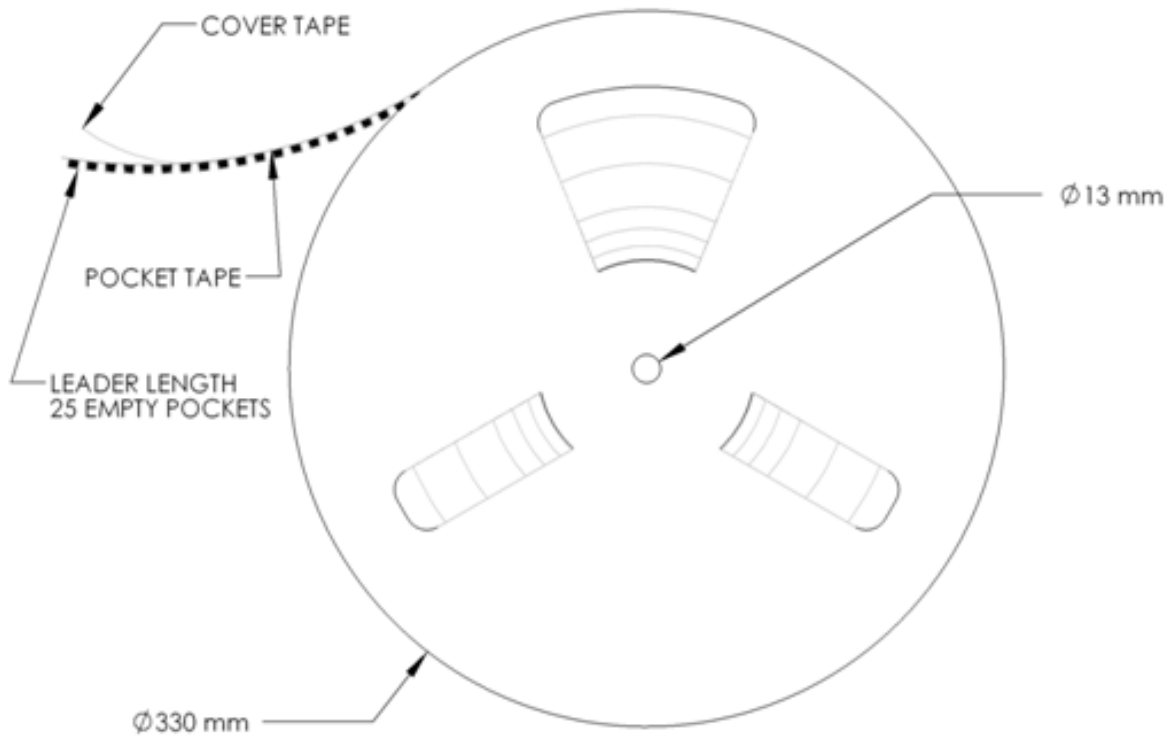

Figure 13: Emitter Reel specifications (mm).

LZC MCPCB Family

Part number	Type of MCPCB	Diameter (mm)	Emitter + MCPCB Thermal Resistance (°C/W)	Typical V_f (V)	Typical I_f (mA)
LZC-Bxxxxx	4-channel	28.3	$0.7 + 0.1 = 0.8$	7.0 – 12.6	4 x 700

LZC-Bxxxxx

4-Channel MCPCB Mechanical Dimensions (mm)

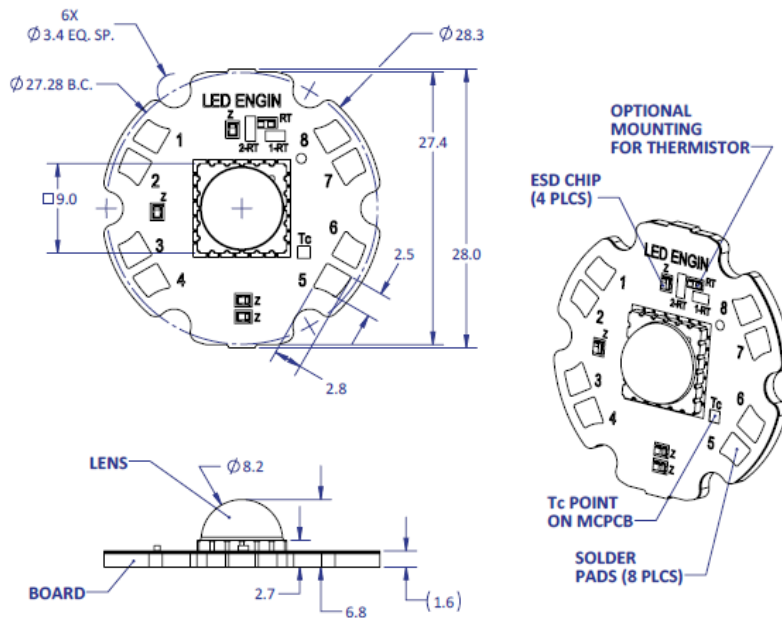

Pad function with:			
LZC-03MA07			
Pad	Polarity	Ch.	Function
7	Anode +	1	Red
2	Cathode -		
8	Anode +	2	Green
1	Cathode -		
5	Anode +	3	Blue
4	Cathode -		
6	Anode +	4	Amber
3	Cathode -		

Notes:

- Unless otherwise noted, the tolerance = ± 0.20 mm.
- Slots in MCPCB are for M3 or #4-40 mounting screws.
- LED Engin recommends using plastic washers to electrically insulate screws from solder pads and electrical traces.
- LED Engin recommends using thermal interface material when attaching the MCPCB to a heat sink.
- The thermal resistance of the MCPCB is: $R_{\theta C-B} 0.1^{\circ}\text{C/W}$

Components used

MCPCB: SuperMCPCB (copper) (Bridge Semiconductor)
ESD chips: BZX884-C18 (NXP, for 3 LED dies in series)

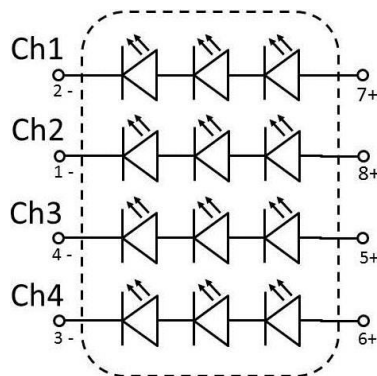

Application Guidelines

MCPCB Assembly Recommendations

A good thermal design requires an efficient heat transfer from the MCPCB to the heat sink. In order to minimize air gaps in between the MCPCB and the heat sink, it is common practice to use thermal interface materials such as thermal pastes, thermal pads, phase change materials and thermal epoxies. Each material has its pros and cons depending on the design. Thermal interface materials are most efficient when the mating surfaces of the MCPCB and the heat sink are flat and smooth. Rough and uneven surfaces may cause gaps with higher thermal resistances, increasing the overall thermal resistance of this interface. It is critical that the thermal resistance of the interface is low, allowing for an efficient heat transfer to the heat sink and keeping MCPCB temperatures low.

When optimizing the thermal performance, attention must also be paid to the amount of stress that is applied on the MCPCB. Too much stress can cause the ceramic emitter to crack. To relax some of the stress, it is advisable to use plastic washers between the screw head and the MCPCB and to follow the torque range listed below. For applications where the heat sink temperature can be above 50°C, it is recommended to use high temperature and rigid plastic washers, such as polycarbonate or glass-filled nylon.

LED Engin recommends the use of the following thermal interface materials:

1. Bergquist's Gap Pad 5000S35, 0.020in thick
 - Part Number: Gap Pad® 5000S35 0.020in/0.508mm
 - Thickness: 0.020in/0.508mm
 - Thermal conductivity: 5 W/m-K
 - Continuous use max temperature: 200°C
 - Using M3 Screw (or #4 screw), with polycarbonate or glass-filled nylon washer (#4) the recommended torque range is: 20 to 25 oz-in (1.25 to 1.56 lbf-in or 0.14 to 0.18 N-m)

2. 3M's Acrylic Interface Pad 5590H
 - Part number: 5590H @ 0.5mm
 - Thickness: 0.020in/0.508mm
 - Thermal conductivity: 3 W/m-K
 - Continuous use max temperature: 100°C
 - Using M3 Screw (or #4 screw), with polycarbonate or glass-filled nylon washer (#4) the recommended torque range is: 20 to 25 oz-in (1.25 to 1.56 lbf-in or 0.14 to 0.18 N-m)

Mechanical Mounting Considerations

The mounting of MCPCB assembly is a critical process step. Excessive mechanical stress build up in the MCPCB can cause the MCPCB to warp which can lead to emitter substrate cracking and subsequent cracking of the LED dies

LED Engin recommends the following steps to avoid mechanical stress build up in the MCPCB:

- Inspect MCPCB and heat sink for flatness and smoothness.
- Select appropriate torque for mounting screws. Screw torque depends on the MCPCB mounting method (thermal interface materials, screws, and washer).
- Always use three M3 or #4-40 screws with #4 washers.
- When fastening the three screws, it is recommended to tighten the screws in multiple small steps. This method avoids building stress by tilting the MCPCB when one screw is tightened in a single step.
- Always use plastic washers in combinations with the three screws. This avoids high point contact stress on the screw head to MCPCB interface, in case the screw is not seated perpendicular.
- In designs with non-tapped holes using self-tapping screws, it is common practice to follow a method of three turns tapping a hole clockwise, followed by half a turn anti-clockwise, until the appropriate torque is reached.

Wire Soldering

- To ease soldering wire to MCPCB process, it is advised to preheat the MCPCB on a hot plate of 125-150°C. Subsequently, apply the solder and additional heat from the solder iron will initiate a good solder reflow. It is recommended to use a solder iron of more than 60W.
- It is advised to use lead-free, no-clean solder. For example: SN-96.5 AG-3.0 CU 0.5 #58/275 from Kester (pn: 24-7068-7601)

About LED Engin

LED Engin, an OSRAM business based in California's Silicon Valley, develops, manufactures, and sells advanced LED emitters, optics and light engines to create uncompromised lighting experiences for a wide range of entertainment, architectural, general lighting and specialty applications. LuxiGen™ multi-die emitter and secondary lens combinations reliably deliver industry-leading flux density, upwards of 5000 quality lumens to a target, in a wide spectrum of colors including whites, tunable whites, multi-color and UV LEDs in a unique patented compact ceramic package. Our LuxiTune™ series of tunable white lighting modules leverage our LuxiGen emitters and lenses to deliver quality, control, freedom and high density tunable white light solutions for a broad range of new recessed and downlighting applications. The small size, yet remarkably powerful beam output and superior in-source color mixing, allows for a previously unobtainable freedom of design wherever high-flux density, directional light is required. LED Engin is committed to providing products that conserve natural resources and reduce greenhouse emissions; and reserves the right to make changes to improve performance without notice.

For more information, please contact LEDE-Sales@osram.com or +1 408 922-7200.