

# 74LVC1G57-Q100

Low-power configurable multiple function gate

Rev. 4 — 1 February 2022

Product data sheet

## 1. General description

The 74LVC1G57-Q100 is a configurable multiple function gate with Schmitt-trigger inputs. The device can be configured as any of the following logic functions AND, OR, NAND, NOR, XNOR, inverter and buffer; using the 3-bit input. All inputs can be connected directly to  $V_{CC}$  or GND. Inputs can be driven from either 3.3 V or 5 V devices. This feature allows the use of these devices as translators in mixed 3.3 V and 5 V environments.

This device is fully specified for partial power down applications using  $I_{OFF}$ . The  $I_{OFF}$  circuitry disables the output, preventing the potentially damaging backflow current through the device when it is powered down.

This product has been qualified to the Automotive Electronics Council (AEC) standard Q100 (Grade 1) and is suitable for use in automotive applications.

## 2. Features and benefits

- Automotive product qualification in accordance with AEC-Q100 (Grade 1)
  - Specified from -40 °C to +85 °C and from -40 °C to +125 °C
- Wide supply voltage range from 1.65 V to 5.5 V
- Overvoltage tolerant inputs to 5.5 V
- High noise immunity
- $\pm 24$  mA output drive ( $V_{CC} = 3.0$  V)
- CMOS low power dissipation
- Latch-up performance exceeds 250 mA
- Direct interface with TTL levels
- $I_{OFF}$  circuitry provides partial Power-down mode operation
- Complies with JEDEC standard:
  - JESD8-7 (1.65 V to 1.95 V)
  - JESD8-5 (2.3 V to 2.7 V)
  - JESD8B/JESD36 (2.7 V to 3.6 V).
- ESD protection:
  - MIL-STD-883, method 3015 exceeds 2000 V
  - HBM JESD22-A114F exceeds 2000 V
  - MM JESD22-A115-A exceeds 200 V (C = 200 pF, R = 0  $\Omega$ )

## 3. Ordering information

Table 1. Ordering information

Type number	Package			
	Temperature range	Name	Description	Version
74LVC1G57GW-Q100	-40 °C to +125 °C	TSSOP6	plastic thin shrink small outline package; 6 leads; body width 1.25 mm	SOT363-2
74LVC1G57GV-Q100	-40 °C to +125 °C	SC-74; TSOP6	plastic surface-mounted package; 6 leads	SOT457

## 4. Marking

Table 2. Marking

Type number	Marking code [1]
74LVC1G57GW-Q100	YC
74LVC1G57GV-Q100	V57

[1] The pin 1 indicator is located on the lower left corner of the device, below the marking code.

## 5. Functional diagram

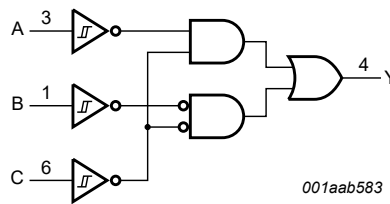

Fig. 1. Logic symbol

## 6. Pinning information

### 6.1. Pinning

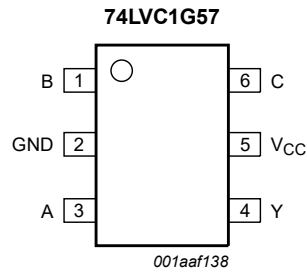

Fig. 2. Pin configuration SOT363-2 (TSSOP6) and SOT457 (SC-74; TSOP6)

### 6.2. Pin description

Table 3. Pin description

Symbol	Pin	Description
B	1	data input
GND	2	ground (0 V)
A	3	data input
Y	4	data output
V <sub>CC</sub>	5	supply voltage
C	6	data input

## 7. Functional description

**Table 4. Function table**

H = HIGH voltage level; L = LOW voltage level.

Input			Output
C	B	A	Y
L	L	L	H
L	L	H	L
L	H	L	H
L	H	H	L
H	L	L	L
H	L	H	L
H	H	L	H
H	H	H	H

### 7.1. Logic configurations

**Table 5. Function selection table**

Logic function	Figure
2-input AND	see <a href="#">Fig. 3</a>
2-input AND with both inputs inverted	see <a href="#">Fig. 6</a>
2-input NAND with inverted input	see <a href="#">Fig. 4</a> and <a href="#">Fig. 5</a>
2-input OR with inverted input	see <a href="#">Fig. 4</a> and <a href="#">Fig. 5</a>
2-input NOR	see <a href="#">Fig. 6</a>
2-input NOR with both inputs inverted	see <a href="#">Fig. 3</a>
2-input XNOR	see <a href="#">Fig. 7</a>
Inverter	see <a href="#">Fig. 8</a>
Buffer	see <a href="#">Fig. 9</a>

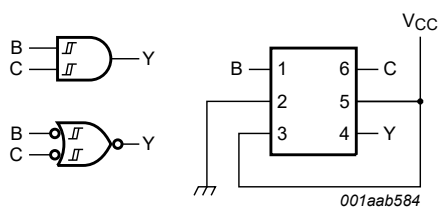

**Fig. 3. 2-input AND gate or 2-input NOR gate with both inputs inverted**

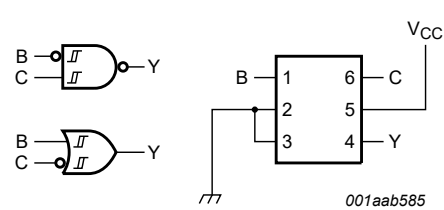

**Fig. 4. 2-input NAND gate with input B inverted or 2-input OR gate with inverted C input**

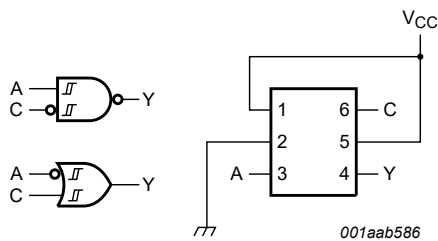

**Fig. 5. 2-input NAND gate with input C inverted or 2-input OR gate with inverted A input**

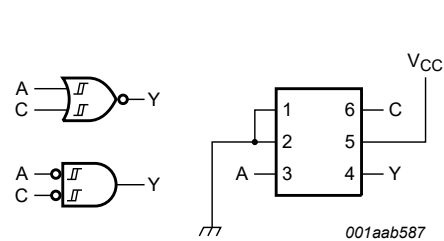

**Fig. 6. 2-input NOR gate or 2-input AND gate with both inputs inverted**

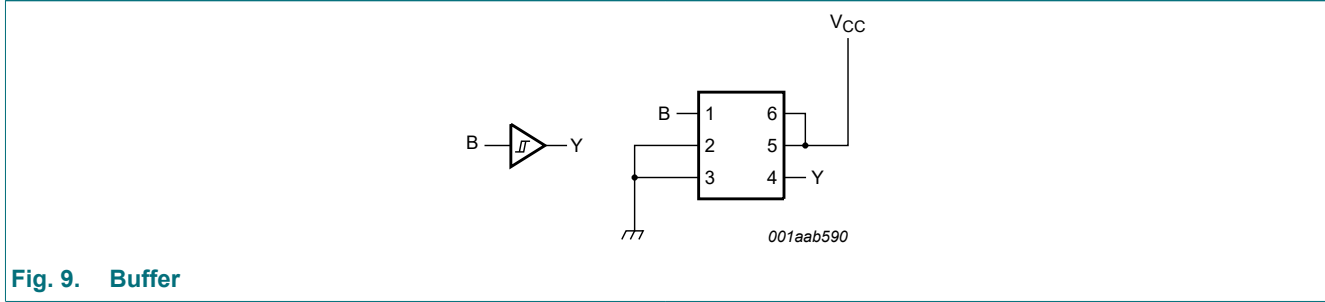
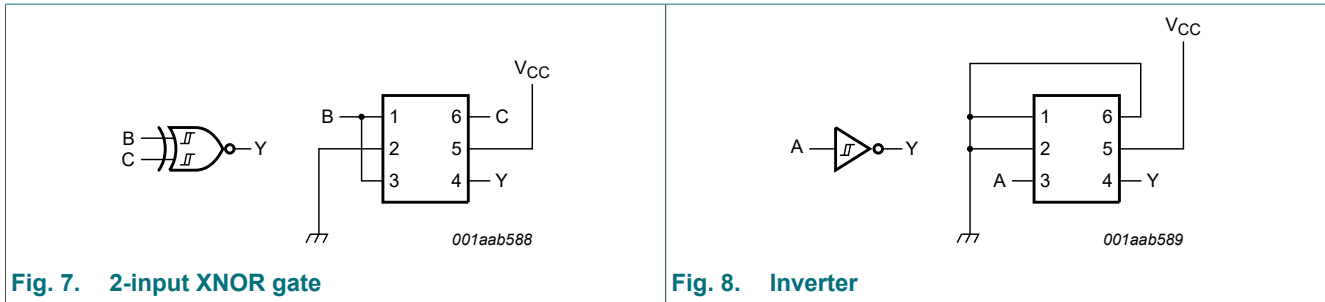

## 8. Limiting values

Table 6. Limiting values

In accordance with the Absolute Maximum Rating System (IEC 60134). Voltages are referenced to GND (ground = 0 V).

Symbol	Parameter	Conditions	Min	Max	Unit	
$V_{CC}$	supply voltage		-0.5	+6.5	V	
$I_{IK}$	input clamping current	$V_I < 0$ V	-50	-	mA	
$V_I$	input voltage	[1]	-0.5	+6.5	V	
$I_{OK}$	output clamping current	$V_O > V_{CC}$ or $V_O < 0$ V	-	$\pm 50$	mA	
$V_O$	output voltage	Active mode	[1]	-0.5	+6.5	V
		Power-down mode; $V_{CC} = 0$ V	[1]	-0.5	+6.5	V
$I_O$	output current	$V_O = 0$ V to $V_{CC}$	-	$\pm 50$	mA	
$I_{CC}$	supply current		-	+100	mA	
$I_{GND}$	ground current		-100	-	mA	
$T_{stg}$	storage temperature		-65	+150	°C	
$P_{tot}$	total power dissipation	$T_{amb} = -40$ °C to +125 °C	[2]	-	250	mW

[1] The input and output voltage ratings may be exceeded if the input and output current ratings are observed.

[2] For SOT363-2 (TSSOP6) package:  $P_{tot}$  derates linearly with 3.7 mW/K above 83 °C.

For SOT457 (SC-74; TSOP6) package:  $P_{tot}$  derates linearly with 4.1 mW/K above 89 °C.

## 9. Recommended operating conditions

Table 7. Recommended operating conditions

Symbol	Parameter	Conditions	Min	Typ	Max	Unit
$V_{CC}$	supply voltage		1.65	-	5.5	V
$V_I$	input voltage		0	-	5.5	V
$V_O$	output voltage	Active mode	0	-	$V_{CC}$	V
		Power-down mode; $V_{CC} = 0$ V	0	-	5.5	V
$T_{amb}$	ambient temperature		-40	-	+125	°C

## 10. Static characteristics

**Table 8. Static characteristics**

At recommended operating conditions; voltages are referenced to GND (ground = 0 V).

Symbol	Parameter	Conditions	-40 °C to +85 °C			-40 °C to +125 °C		Unit
			Min	Typ [1]	Max	Min	Max	
V <sub>OL</sub>	LOW-level output voltage	V <sub>I</sub> = V <sub>T+</sub> or V <sub>T-</sub>						
		I <sub>O</sub> = 100 μA; V <sub>CC</sub> = 1.65 V to 5.5 V	-	-	0.1	-	0.1	V
		I <sub>O</sub> = 4 mA; V <sub>CC</sub> = 1.65 V	-	-	0.45	-	0.7	V
		I <sub>O</sub> = 8 mA; V <sub>CC</sub> = 2.3 V	-	-	0.3	-	0.45	V
		I <sub>O</sub> = 12 mA; V <sub>CC</sub> = 2.7 V	-	-	0.4	-	0.6	V
		I <sub>O</sub> = 24 mA; V <sub>CC</sub> = 3.0 V	-	-	0.55	-	0.8	V
		I <sub>O</sub> = 32 mA; V <sub>CC</sub> = 4.5 V	-	-	0.55	-	0.8	V
V <sub>OH</sub>	HIGH-level output voltage	V <sub>I</sub> = V <sub>T+</sub> or V <sub>T-</sub>						
		I <sub>O</sub> = -100 μA; V <sub>CC</sub> = 1.65 V to 5.5 V	V <sub>CC</sub> - 0.1	-	-	V <sub>CC</sub> - 0.1	-	V
		I <sub>O</sub> = -4 mA; V <sub>CC</sub> = 1.65 V	1.2	-	-	0.95	-	V
		I <sub>O</sub> = -8 mA; V <sub>CC</sub> = 2.3 V	1.9	-	-	1.7	-	V
		I <sub>O</sub> = -12 mA; V <sub>CC</sub> = 2.7 V	2.2	-	-	1.9	-	V
		I <sub>O</sub> = -24 mA; V <sub>CC</sub> = 3.0 V	2.3	-	-	2.0	-	V
		I <sub>O</sub> = -32 mA; V <sub>CC</sub> = 4.5 V	3.8	-	-	3.4	-	V
I <sub>I</sub>	input leakage current	V <sub>I</sub> = 5.5 V or GND; V <sub>CC</sub> = 0 V to 5.5 V	-	±0.1	±1	-	±1	μA
I <sub>OFF</sub>	power-off leakage current	V <sub>I</sub> or V <sub>O</sub> = 5.5 V; V <sub>CC</sub> = 0 V	-	±0.1	±2	-	±2	μA
I <sub>CC</sub>	supply current	V <sub>I</sub> = 5.5 V or GND; I <sub>O</sub> = 0 A; V <sub>CC</sub> = 1.65 V to 5.5 V	-	0.1	4	-	4	μA
ΔI <sub>CC</sub>	additional supply current	V <sub>I</sub> = V <sub>CC</sub> - 0.6 V; I <sub>O</sub> = 0 A; V <sub>CC</sub> = 2.3 V to 5.5 V	-	5	500	-	500	μA
C <sub>I</sub>	input capacitance		-	2.5	-	-	-	pF

[1] Typical values are measured at maximum V<sub>CC</sub> and T<sub>amb</sub> = 25 °C.

## 11. Dynamic characteristics

**Table 9. Dynamic characteristics**

Voltages are referenced to GND (ground = 0 V); for test circuit see Fig. 11.

Symbol	Parameter	Conditions	-40 °C to +85 °C			-40 °C to +125 °C		Unit
			Min	Typ [1]	Max	Min	Max	
t <sub>pd</sub>	propagation delay	A, B, C to Y; see Fig. 10 [2]						
		V <sub>CC</sub> = 1.65 V to 1.95 V	1.0	6.0	14.4	1.0	18	ns
		V <sub>CC</sub> = 2.3 V to 2.7 V	0.5	3.5	8.3	0.5	10.4	ns
		V <sub>CC</sub> = 2.7 V	0.5	4.2	8.5	0.5	10.6	ns
		V <sub>CC</sub> = 3.0 V to 3.6 V	0.5	3.8	6.3	0.5	7.9	ns
		V <sub>CC</sub> = 4.5 V to 5.5 V	0.5	3.0	5.1	0.5	6.4	ns
C <sub>PD</sub>	power dissipation capacitance	V <sub>CC</sub> = 3.3 V; V <sub>I</sub> = GND to V <sub>CC</sub> [3]	-	22	-	-	-	pF

[1] Typical values are measured at nominal V<sub>CC</sub> and at T<sub>amb</sub> = 25 °C.

[2] t<sub>pd</sub> is the same as t<sub>PLH</sub> and t<sub>PHL</sub>.

[3] C<sub>PD</sub> is used to determine the dynamic power dissipation (P<sub>D</sub> in μW).

$$P_D = C_{PD} \times V_{CC}^2 \times f_i \times N + \Sigma(C_L \times V_{CC}^2 \times f_o) \text{ where:}$$

f<sub>i</sub> = input frequency in MHz;

f<sub>o</sub> = output frequency in MHz;

C<sub>L</sub> = output load capacitance in pF;

V<sub>CC</sub> = supply voltage in V;

N = number of inputs switching;

Σ(C<sub>L</sub> × V<sub>CC</sub><sup>2</sup> × f<sub>o</sub>) = sum of outputs.

### 11.1. Waveforms and test circuit

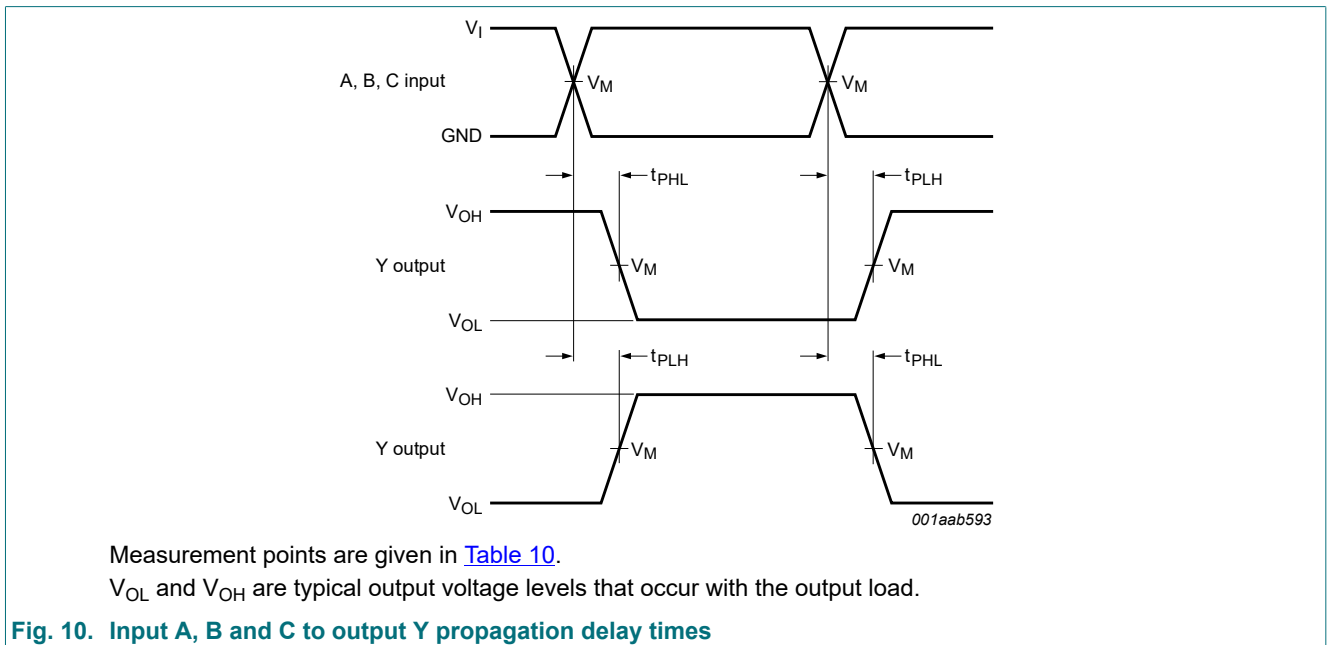
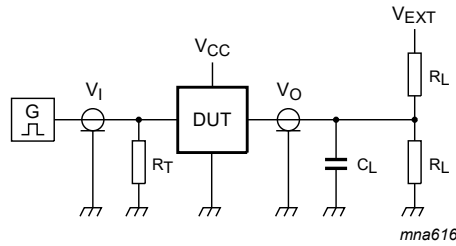

Table 10. Measurement points

Supply voltage	Input		Output
$V_{CC}$	$V_M$	$V_I$	$V_M$
1.65 V to 1.95 V	$0.5 \times V_{CC}$	$V_{CC}$	$0.5 \times V_{CC}$
2.3 V to 2.7 V	$0.5 \times V_{CC}$	$V_{CC}$	$0.5 \times V_{CC}$
2.7 V	1.5 V	2.7 V	1.5 V
3.0 V to 3.6 V	1.5 V	2.7 V	1.5 V
4.5 V to 5.5 V	$0.5 \times V_{CC}$	$V_{CC}$	$0.5 \times V_{CC}$



Measurement points are given in [Table 11](#).

Definitions test circuit:

$R_L$  = Load resistance;

$C_L$  = Load capacitance including jig and probe capacitance;

$R_T$  = Termination resistance should be equal to output impedance  $Z_o$  of the pulse generator;

$V_{EXT}$  = External voltage for measuring switching times.

Fig. 11. Test circuit for measuring switching times

Table 11. Test data

Supply voltage	Input		Load		$V_{EXT}$
$V_{CC}$	$V_I$	$t_r = t_f$	$C_L$	$R_L$	$t_{PLH}, t_{PHL}$
1.65 V to 1.95 V	$V_{CC}$	$\leq 2.0$ ns	30 pF	1 k $\Omega$	open
2.3 V to 2.7 V	$V_{CC}$	$\leq 2.0$ ns	30 pF	500 $\Omega$	open
2.7 V	2.7 V	$\leq 2.5$ ns	50 pF	500 $\Omega$	open
3.0 V to 3.6 V	2.7 V	$\leq 2.5$ ns	50 pF	500 $\Omega$	open
4.5 V to 5.5 V	$V_{CC}$	$\leq 2.5$ ns	50 pF	500 $\Omega$	open

## 12. Transfer characteristics

**Table 12. Transfer characteristics**

At recommended operating conditions; voltages are referenced to GND (ground = 0 V).

Symbol	Parameter	Conditions	-40 °C to +85 °C			-40 °C to +125 °C		Unit
			Min	Typ [1]	Max	Min	Max	
V <sub>T+</sub>	positive-going threshold voltage	see <a href="#">Fig. 12</a> , <a href="#">Fig. 13</a> , <a href="#">Fig. 14</a> and <a href="#">Fig. 15</a>						
		V <sub>CC</sub> = 1.8 V	0.70	1.02	1.20	0.67	1.20	V
		V <sub>CC</sub> = 2.3 V	1.11	1.42	1.60	1.08	1.60	V
		V <sub>CC</sub> = 3.0 V	1.50	1.79	2.00	1.47	2.00	V
		V <sub>CC</sub> = 4.5 V	2.16	2.52	2.74	2.13	2.74	V
V <sub>T-</sub>	negative-going threshold voltage	see <a href="#">Fig. 12</a> , <a href="#">Fig. 13</a> , <a href="#">Fig. 14</a> and <a href="#">Fig. 15</a>						
		V <sub>CC</sub> = 1.8 V	0.30	0.53	0.72	0.30	0.75	V
		V <sub>CC</sub> = 2.3 V	0.58	0.77	1.00	0.58	1.03	V
		V <sub>CC</sub> = 3.0 V	0.80	1.04	1.30	0.80	1.33	V
		V <sub>CC</sub> = 4.5 V	1.21	1.55	1.90	1.21	1.93	V
V <sub>H</sub>	hysteresis voltage	(V <sub>T+</sub> - V <sub>T-</sub> ); see <a href="#">Fig. 12</a> , <a href="#">Fig. 13</a> , <a href="#">Fig. 14</a> and <a href="#">Fig. 15</a>						
		V <sub>CC</sub> = 1.8 V	0.30	0.48	0.62	0.23	0.62	V
		V <sub>CC</sub> = 2.3 V	0.40	0.64	0.80	0.34	0.80	V
		V <sub>CC</sub> = 3.0 V	0.50	0.75	1.00	0.44	1.00	V
		V <sub>CC</sub> = 4.5 V	0.71	0.97	1.20	0.65	1.20	V
		V <sub>CC</sub> = 5.5 V	0.71	1.13	1.40	0.65	1.40	V

[1] Typical values are measured at T<sub>amb</sub> = 25 °C.

### 12.1. Waveforms transfer characteristics

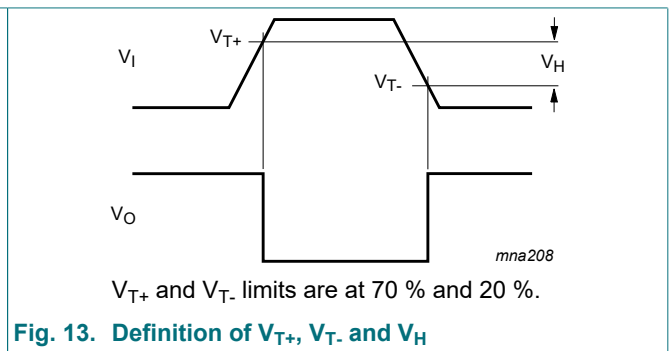
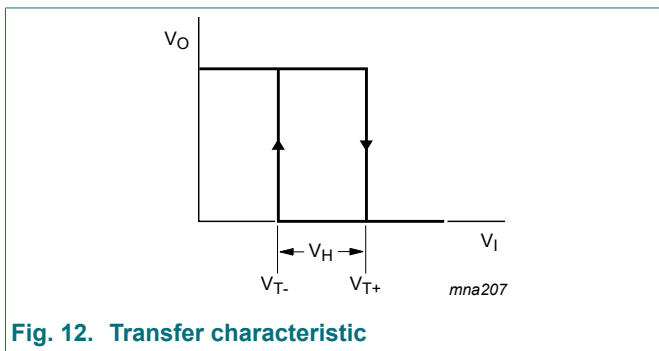



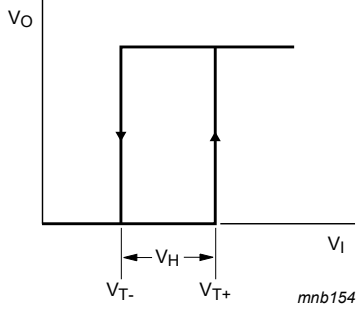
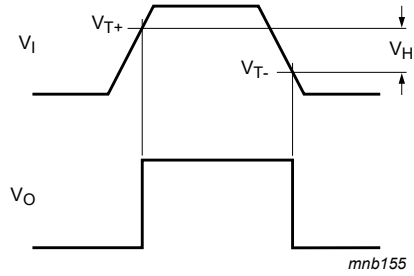

Fig. 14. Transfer characteristic



$V_{T+}$  and  $V_{T-}$  limits are at 70 % and 20 %.

Fig. 15. Definition of  $V_{T+}$ ,  $V_{T-}$  and  $V_H$

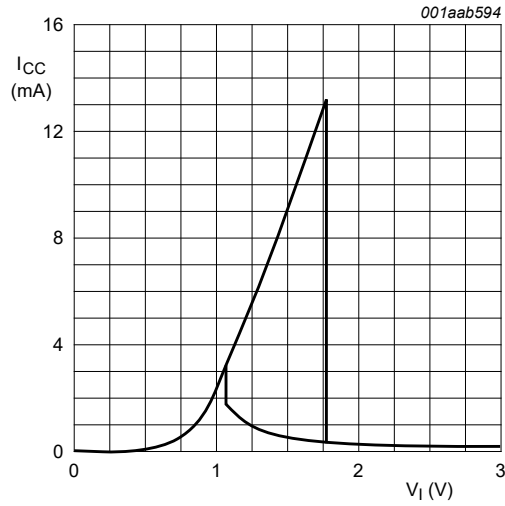

Fig. 16. Typical 74LVC1G57-Q100 transfer characteristic;  $V_{CC} = 3.0$  V

### 13. Package outline

TSSOP6: plastic thin shrink small outline package; 6 leads; body width 1.25 mm

SOT363-2



Fig. 17. Package outline SOT363-2 (TSSOP6)

Plastic, surface-mounted package (SC-74; TSOP6); 6 leads

SOT457



Fig. 18. Package outline SOT457 (SC-74; TSOP6)

## 14. Abbreviations

Table 13. Abbreviations

Acronym	Description
CMOS	Complementary Metal Oxide Semiconductor
DUT	Device Under Test
ESD	ElectroStatic Discharge
HBM	Human Body Model
MIL	Military
MM	Machine Model
TTL	Transistor-Transistor Logic

## 15. Revision history

Table 14. Revision history

Document ID	Release date	Data sheet status	Change notice	Supersedes
74LVC1G57_Q100 v.4	20220201	Product data sheet	-	74LVC1G57_Q100 v.3
Modifications:	<ul style="list-style-type: none"> <li>Package SOT363 (SC-88) changed to SOT363-2 (TSSOP6).</li> </ul>			
74LVC1G57_Q100 v.3	20210604	Product data sheet	-	74LVC1G57_Q100 v.2
Modifications:	<ul style="list-style-type: none"> <li>The format of this data sheet has been redesigned to comply with the identity guidelines of Nexperia.</li> <li>Legal texts have been adapted to the new company name where appropriate.</li> <li><a href="#">Section 1</a> and <a href="#">Section 2</a> updated.</li> <li><a href="#">Section 8</a>: Derating values for <math>P_{tot}</math> total power dissipation updated.</li> <li><a href="#">Fig. 18</a>: Package outline drawing SOT457 (SC-74; TSOP6) updated.</li> </ul>			
74LVC1G57_Q100 v.2	20161209	Product data sheet	-	74LVC1G57_Q100 v.1
Modifications:	<ul style="list-style-type: none"> <li><a href="#">Table 8</a>: The maximum limits for leakage current and supply current have changed.</li> </ul>			
74LVC1G57_Q100 v.1	20140415	Product data sheet	-	-

## 16. Legal information

### Data sheet status

Document status [1][2]	Product status [3]	Definition
Objective [short] data sheet	Development	This document contains data from the objective specification for product development.
Preliminary [short] data sheet	Qualification	This document contains data from the preliminary specification.
Product [short] data sheet	Production	This document contains the product specification.

- [1] Please consult the most recently issued document before initiating or completing a design.
- [2] The term 'short data sheet' is explained in section "Definitions".
- [3] The product status of device(s) described in this document may have changed since this document was published and may differ in case of multiple devices. The latest product status information is available on the internet at <https://www.nexperia.com>.

### Definitions

**Draft** — The document is a draft version only. The content is still under internal review and subject to formal approval, which may result in modifications or additions. Nexperia does not give any representations or warranties as to the accuracy or completeness of information included herein and shall have no liability for the consequences of use of such information.

**Short data sheet** — A short data sheet is an extract from a full data sheet with the same product type number(s) and title. A short data sheet is intended for quick reference only and should not be relied upon to contain detailed and full information. For detailed and full information see the relevant full data sheet, which is available on request via the local Nexperia sales office. In case of any inconsistency or conflict with the short data sheet, the full data sheet shall prevail.

**Product specification** — The information and data provided in a Product data sheet shall define the specification of the product as agreed between Nexperia and its customer, unless Nexperia and customer have explicitly agreed otherwise in writing. In no event however, shall an agreement be valid in which the Nexperia product is deemed to offer functions and qualities beyond those described in the Product data sheet.

### Disclaimers

**Limited warranty and liability** — Information in this document is believed to be accurate and reliable. However, Nexperia does not give any representations or warranties, expressed or implied, as to the accuracy or completeness of such information and shall have no liability for the consequences of use of such information. Nexperia takes no responsibility for the content in this document if provided by an information source outside of Nexperia.

In no event shall Nexperia be liable for any indirect, incidental, punitive, special or consequential damages (including - without limitation - lost profits, lost savings, business interruption, costs related to the removal or replacement of any products or rework charges) whether or not such damages are based on tort (including negligence), warranty, breach of contract or any other legal theory.

Notwithstanding any damages that customer might incur for any reason whatsoever, Nexperia's aggregate and cumulative liability towards customer for the products described herein shall be limited in accordance with the Terms and conditions of commercial sale of Nexperia.

**Right to make changes** — Nexperia reserves the right to make changes to information published in this document, including without limitation specifications and product descriptions, at any time and without notice. This document supersedes and replaces all information supplied prior to the publication hereof.

**Suitability for use in automotive applications** — This Nexperia product has been qualified for use in automotive applications. Unless otherwise agreed in writing, the product is not designed, authorized or warranted to be suitable for use in life support, life-critical or safety-critical systems or

equipment, nor in applications where failure or malfunction of an Nexperia product can reasonably be expected to result in personal injury, death or severe property or environmental damage. Nexperia and its suppliers accept no liability for inclusion and/or use of Nexperia products in such equipment or applications and therefore such inclusion and/or use is at the customer's own risk.

**Quick reference data** — The Quick reference data is an extract of the product data given in the Limiting values and Characteristics sections of this document, and as such is not complete, exhaustive or legally binding.

**Applications** — Applications that are described herein for any of these products are for illustrative purposes only. Nexperia makes no representation or warranty that such applications will be suitable for the specified use without further testing or modification.

Customers are responsible for the design and operation of their applications and products using Nexperia products, and Nexperia accepts no liability for any assistance with applications or customer product design. It is customer's sole responsibility to determine whether the Nexperia product is suitable and fit for the customer's applications and products planned, as well as for the planned application and use of customer's third party customer(s). Customers should provide appropriate design and operating safeguards to minimize the risks associated with their applications and products.

Nexperia does not accept any liability related to any default, damage, costs or problem which is based on any weakness or default in the customer's applications or products, or the application or use by customer's third party customer(s). Customer is responsible for doing all necessary testing for the customer's applications and products using Nexperia products in order to avoid a default of the applications and the products or of the application or use by customer's third party customer(s). Nexperia does not accept any liability in this respect.

**Limiting values** — Stress above one or more limiting values (as defined in the Absolute Maximum Ratings System of IEC 60134) will cause permanent damage to the device. Limiting values are stress ratings only and (proper) operation of the device at these or any other conditions above those given in the Recommended operating conditions section (if present) or the Characteristics sections of this document is not warranted. Constant or repeated exposure to limiting values will permanently and irreversibly affect the quality and reliability of the device.

**Terms and conditions of commercial sale** — Nexperia products are sold subject to the general terms and conditions of commercial sale, as published at <http://www.nexperia.com/profile/terms>, unless otherwise agreed in a valid written individual agreement. In case an individual agreement is concluded only the terms and conditions of the respective agreement shall apply. Nexperia hereby expressly objects to applying the customer's general terms and conditions with regard to the purchase of Nexperia products by customer.

**No offer to sell or license** — Nothing in this document may be interpreted or construed as an offer to sell products that is open for acceptance or the grant, conveyance or implication of any license under any copyrights, patents or other industrial or intellectual property rights.

**Export control** — This document as well as the item(s) described herein may be subject to export control regulations. Export might require a prior authorization from competent authorities.

**Translations** — A non-English (translated) version of a document is for reference only. The English version shall prevail in case of any discrepancy between the translated and English versions.

### Trademarks

Notice: All referenced brands, product names, service names and trademarks are the property of their respective owners.

## Contents

<b>1. General description</b> .....	<b>1</b>
<b>2. Features and benefits</b> .....	<b>1</b>
<b>3. Ordering information</b> .....	<b>1</b>
<b>4. Marking</b> .....	<b>2</b>
<b>5. Functional diagram</b> .....	<b>2</b>
<b>6. Pinning information</b> .....	<b>2</b>
6.1. Pinning.....	2
6.2. Pin description.....	2
<b>7. Functional description</b> .....	<b>3</b>
7.1. Logic configurations.....	3
<b>8. Limiting values</b> .....	<b>4</b>
<b>9. Recommended operating conditions</b> .....	<b>4</b>
<b>10. Static characteristics</b> .....	<b>5</b>
<b>11. Dynamic characteristics</b> .....	<b>6</b>
11.1. Waveforms and test circuit.....	6
<b>12. Transfer characteristics</b> .....	<b>8</b>
12.1. Waveforms transfer characteristics.....	8
<b>13. Package outline</b> .....	<b>10</b>
<b>14. Abbreviations</b> .....	<b>12</b>
<b>15. Revision history</b> .....	<b>12</b>
<b>16. Legal information</b> .....	<b>13</b>

© Nexperia B.V. 2022. All rights reserved

For more information, please visit: <http://www.nexperia.com>  
For sales office addresses, please send an email to: [salesaddresses@nexperia.com](mailto:salesaddresses@nexperia.com)  
Date of release: 1 February 2022