

# 2.4 GHz WiFi Antenna

10 x 3.2 x 4.0 mm Ceramic Chip Antenna (On Ground type, Top surface ground removal area 10.80 x 6.25 mm).  
Pulse Part Number: W3001

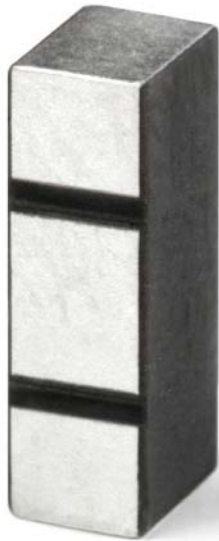

## Features

- Omni directional radiation (Azimuthal plane)
- Low profile
- Compact size W x L x H (10 x 3.2 x 4 mm)
- Low weight (600 mg)
- Lead free materials
- Fully SMD compatible
- Lead free soldering compatible
- Tape and reel packing
- RoHS compliant product

## Applications

- Bluetooth
- 2.4 GHz WLAN
- 2.4 GHz ISM Band System

## Electrical specifications @ +25 °C

*Note: Electrical characteristics depend on test board (GP) size and antenna positioning on GP and Ground Clearance area size.*

## WiFi 2.4 GHz

Typical performance

(Test board size 80 x 37 mm, PWB top surface ground removal area 10.80 x 6.25 mm, position 1 on PWB)

Frequency Range [MHz]	Max Gain [dBi]	Efficiency [%] / [dB]	Return loss min. [dB]	Impedance [ $\Omega$ ]	Operating Temperature [° C]
2400 – 2483.5	1.5 (Peak) 0.5 (Band edges)	75 /-1.25 (Peak) 60/-2.25 (Band edges)	-6	50	-45 to +85

## Pulse Finland Oy

Takatie 6  
90440 Kempele, Finland  
Tel: +358 207 935 500  
Fax: +358 207 935 501

[www.pulseeng.com/antennas](http://www.pulseeng.com/antennas)



# 2.4 GHz WiFi Antenna

10 x 3.2 x 4.0 mm Ceramic Chip Antenna (On Ground type, Top surface ground removal area 10.80 x 6.25 mm).  
Pulse Part Number: W3001

## Terminal Configuration and Dimensions

On Ground type, Top surface ground removal area 10.80 x 6.25 mm

### Antenna features

No.	Terminal name	Terminal Dimensions
1	Feed / GND	1.5 x 2.75 mm
2	Feed / GND	1.5 x 2.75 mm

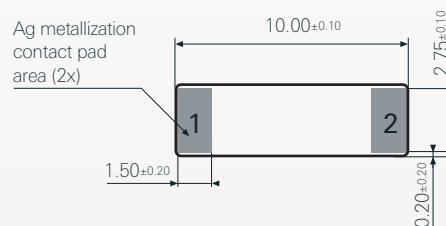

Antenna is symmetrical.

Either of terminals 1 or 2 can be feed / GND

## Antenna PWB Layout Specifications

On Ground type, Top surface ground removal area 10.80 x 6.25 mm

Matching and tuning component values depend on application and surrounding mechanics / materials.

Feed line should be designed to match 50 Ω characteristic impedance, depending on PWB material and thickness.

Recommended test board layout for electrical characteristic measurement, test board outline size 80 x 37 mm.

### PWB layout for W3001 Antenna

Note: All dimensions are in metric system.

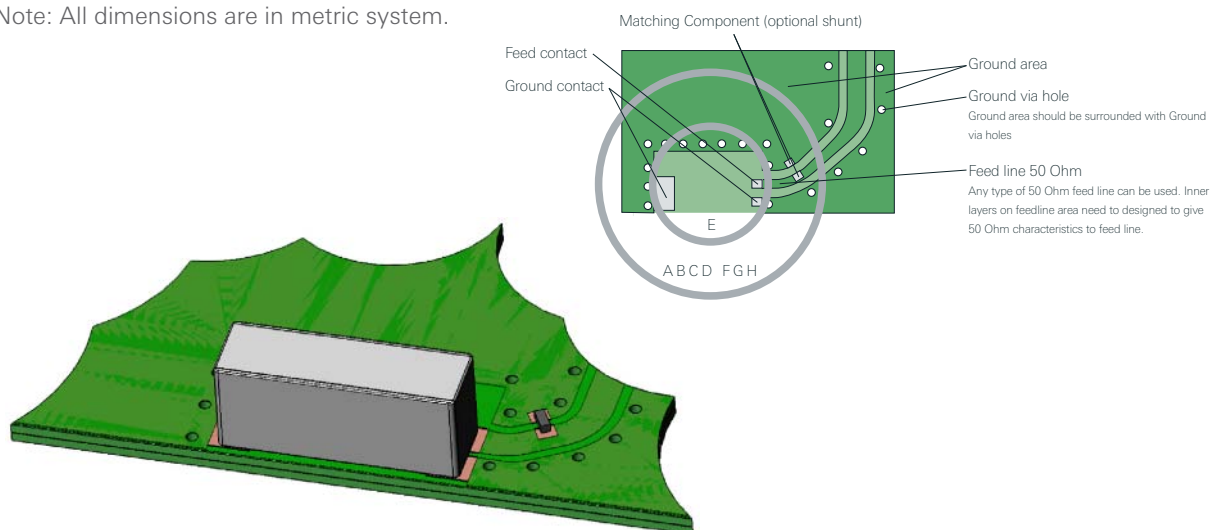

# 2.4 GHz WiFi Antenna

10 x 3.2 x 4.0 mm Ceramic Chip Antenna (0n Ground type, Top surface ground removal area 10.80 x 6.25 mm).  
Pulse Part Number: W3001

## Metallization layers for W3001 Antenna

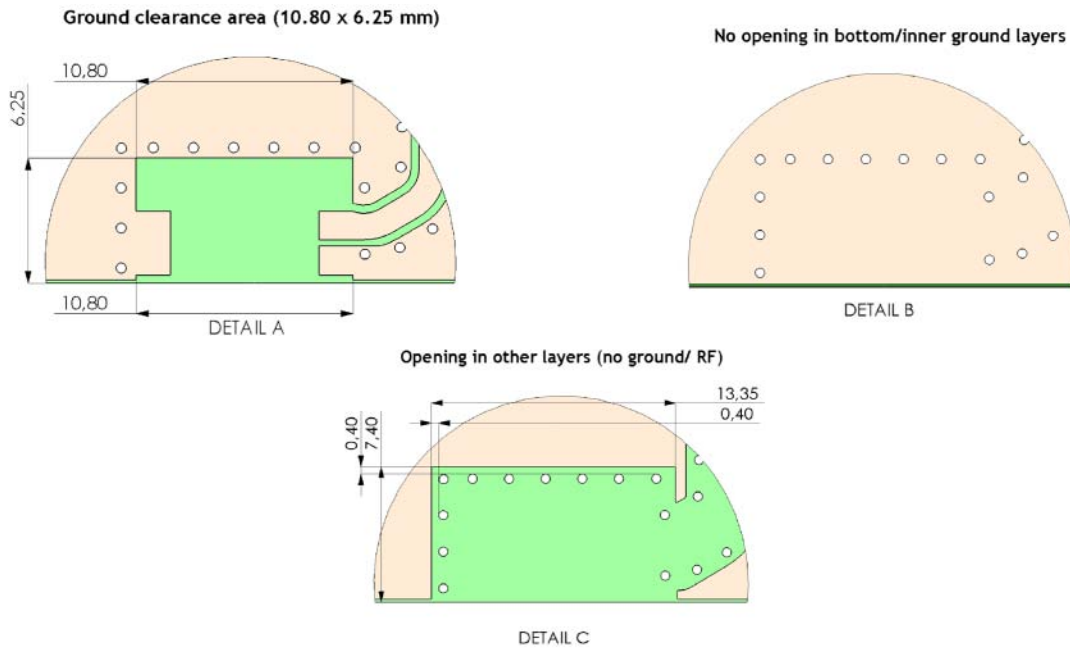

## PWB pad dimensions and antenna position for W3001 Antenna

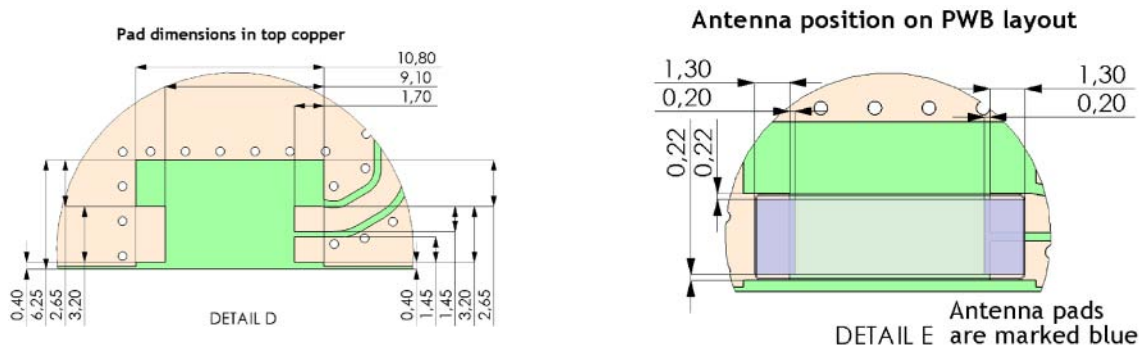

# 2.4 GHz WiFi Antenna

10 x 3.2 x 4.0 mm Ceramic Chip Antenna (0n Ground type, Top surface ground removal area 10.80 x 6.25 mm).  
 Pulse Part Number: W3001

## Typical ground via hole placement in PWB layout for W3001 Antenna

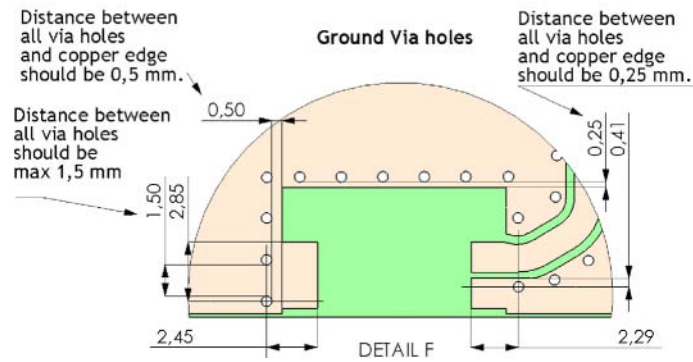

## Solder resist opening and Paste stencil recommendation for W3001 Antenna

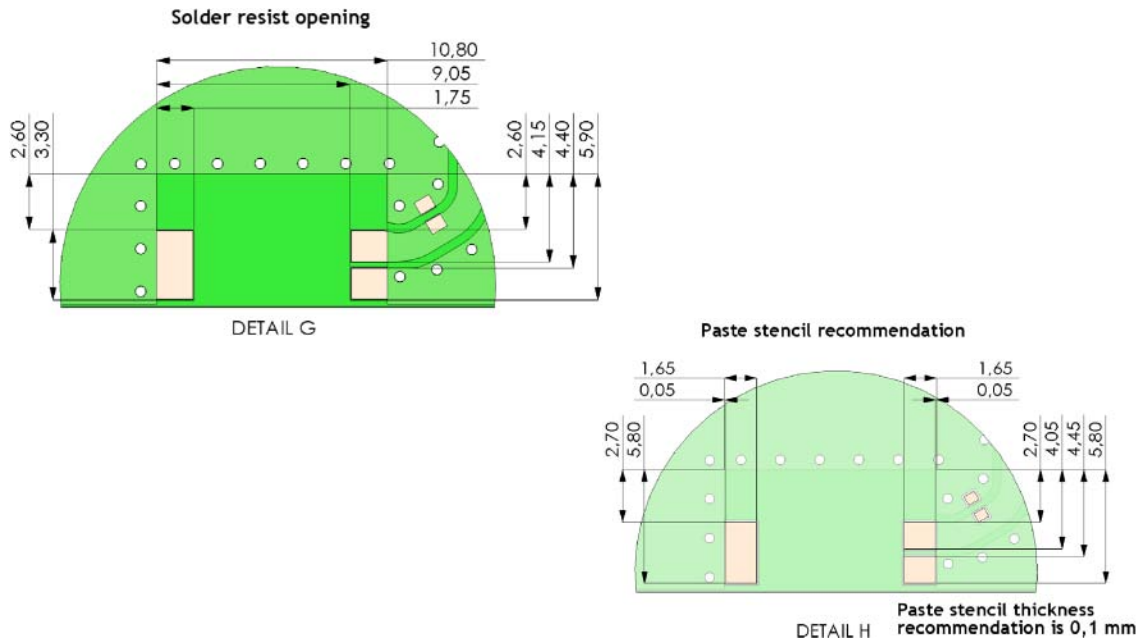

# 2.4 GHz WiFi Antenna

10 x 3.2 x 4.0 mm Ceramic Chip Antenna (On Ground type, Top surface ground removal area 10.80 x 6.25 mm).  
Pulse Part Number: W3001

## Recommended antenna position on PWB for W3001 Antenna

Our test PWB size is 37 x 80 mm, other sized boards can be used depending on customer device size (minimum 35 x 35 mm).

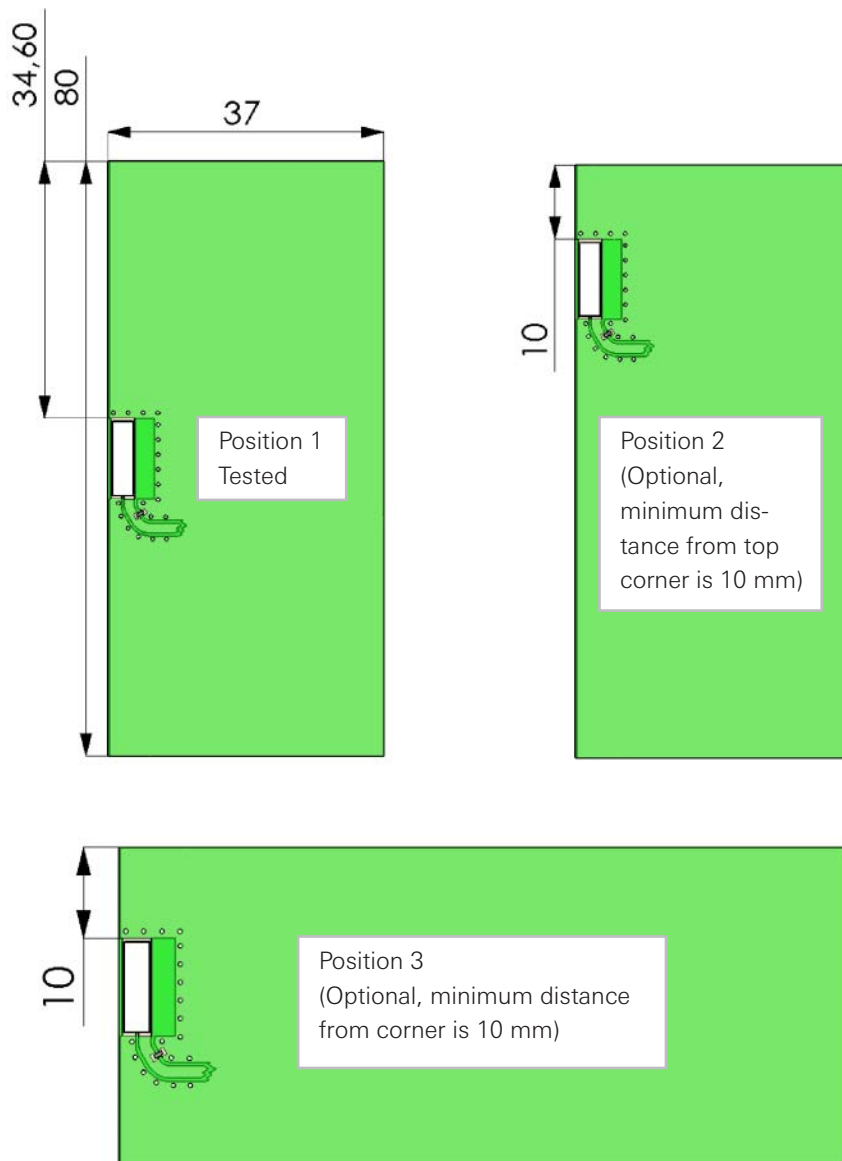

# 2.4 GHz WiFi Antenna

10 x 3.2 x 4.0 mm Ceramic Chip Antenna (0n Ground type, Top surface ground removal area 10.80 x 6.25 mm).  
Pulse Part Number: W3001

## Typical Electrical Characteristics (T=25 °C)

Measured on the 80 x 37 mm test board with matching circuit (1.2 pF shunt matching capacitor on feed). Measured in antenna position 1 on PWB layout, see previous page.

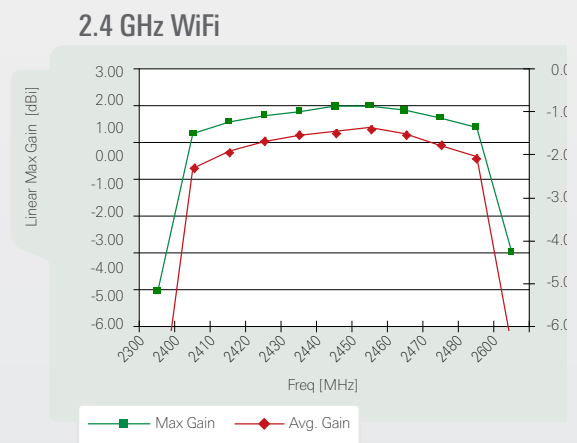
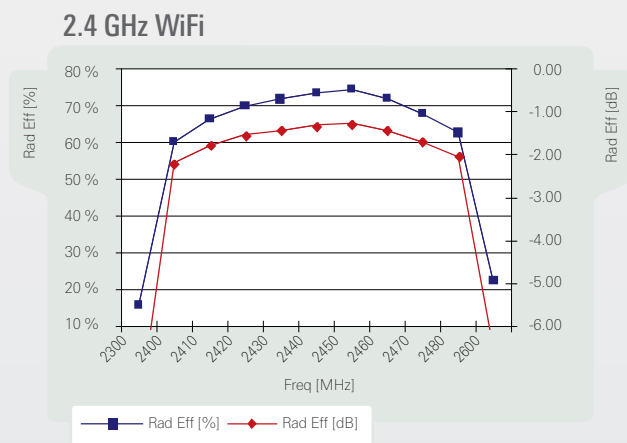
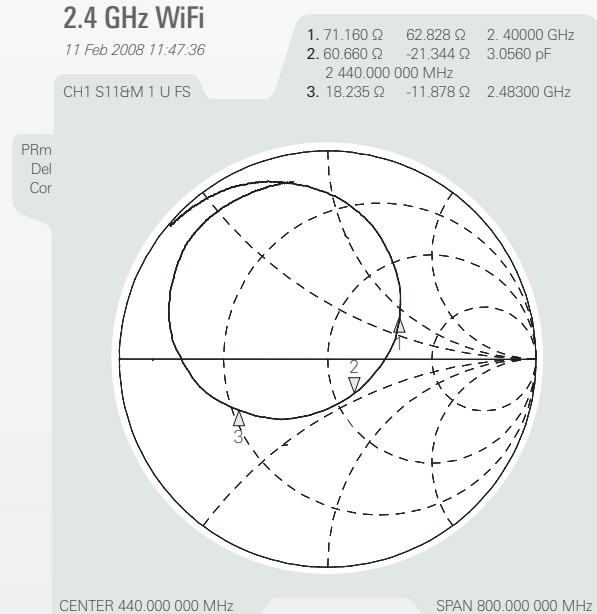
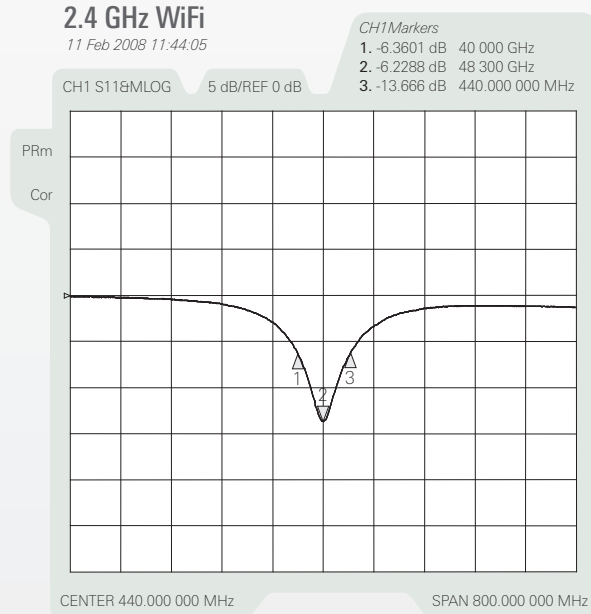

**Pulse Finland Oy**

Takatie 6  
90440 Kempele, Finland  
Tel: +358 207 935 500  
Fax: +358 207 935 501

[www.pulseeng.com/antennas](http://www.pulseeng.com/antennas)



# 2.4 GHz WiFi Antenna

10 x 3.2 x 4.0 mm Ceramic Chip Antenna (0n Ground type, Top surface ground removal area 10.80 x 6.25 mm).  
Pulse Part Number: W3001

## Typical Free Space Radiation Patterns

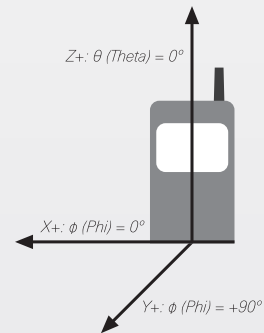
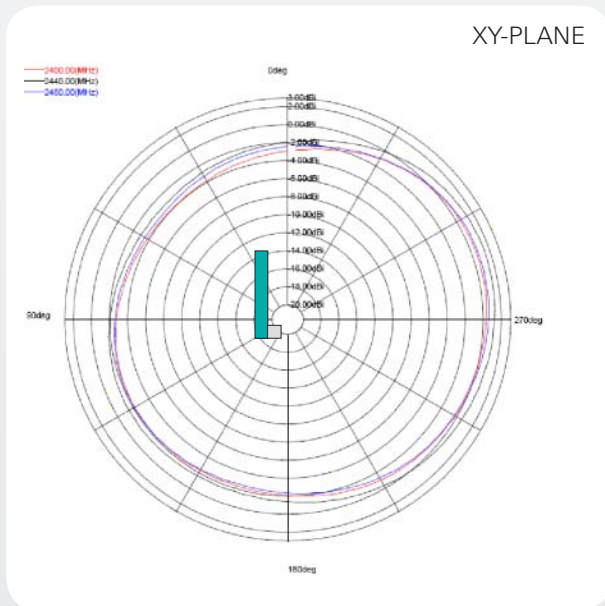
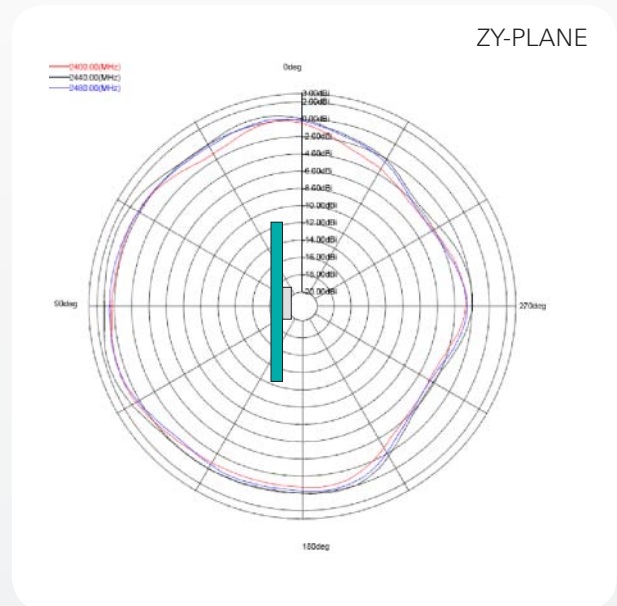
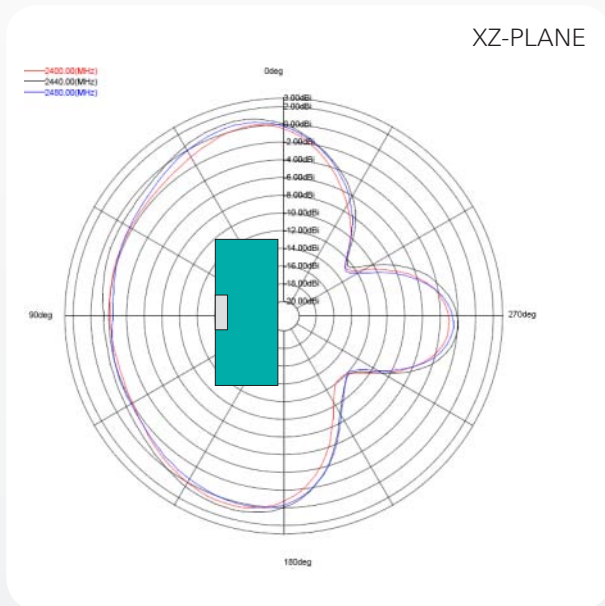

Pulse Finland Oy

Takatie 6  
90440 Kempele, Finland  
Tel: +358 207 935 500  
Fax: +358 207 935 501

[www.pulseeng.com/antennas](http://www.pulseeng.com/antennas)



# 2.4 GHz WiFi Antenna

10 x 3.2 x 4.0 mm Ceramic Chip Antenna (0n Ground type, Top surface ground removal area 10.80 x 6.25 mm).  
Pulse Part Number: W3001

## Packing

Tape and reel packing is used. Carrier tape, reel and box dimensions are presented in following pictures.

## Carrier Tape

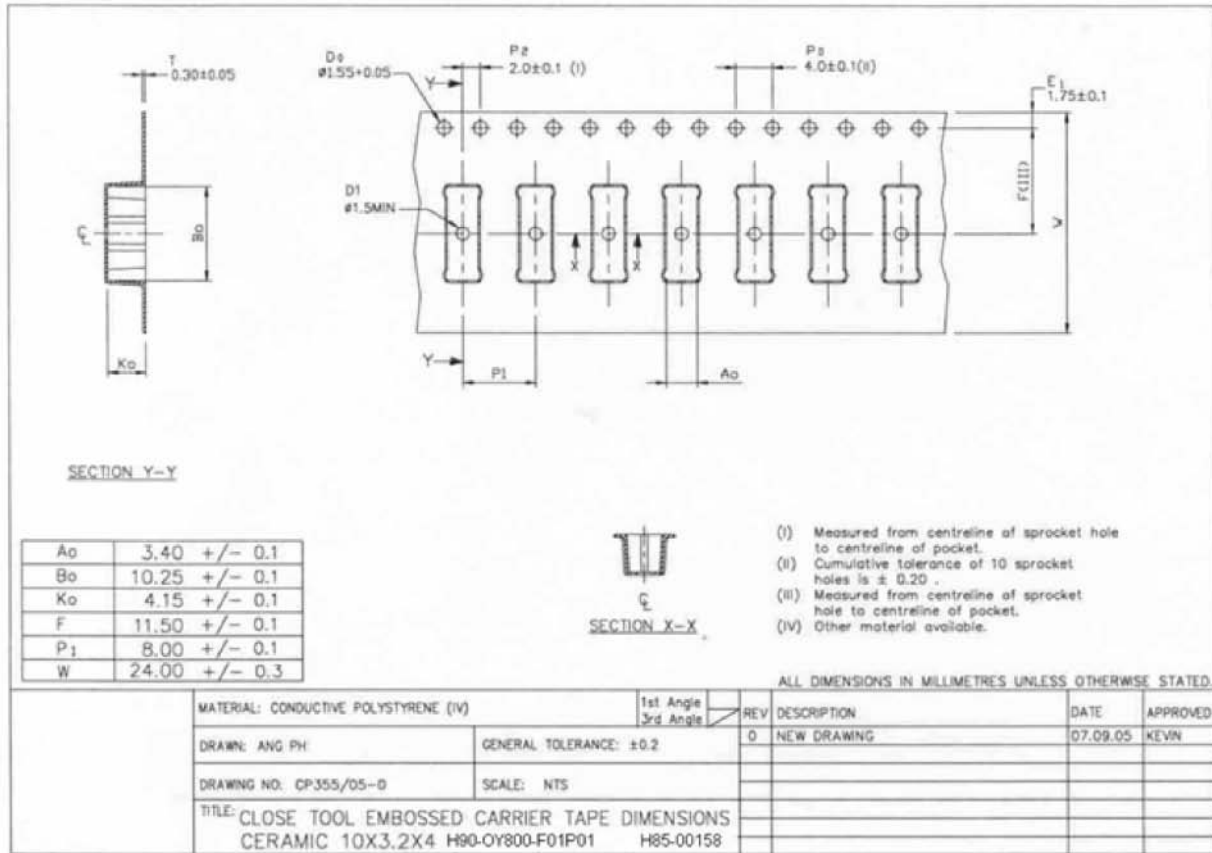

## Block Orientation

Antenna soldering pads facing down to the bottom of the carrier tape.

Top View of the Carrier Tape



Top Surface of the Antenna

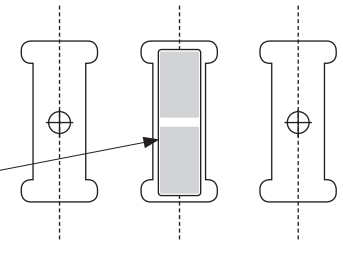



# 2.4 GHz WiFi Antenna

10 x 3.2 x 4.0 mm Ceramic Chip Antenna (On Ground type, Top surface ground removal area 10.80 x 6.25 mm).  
Pulse Part Number: W3001

## Packing Form

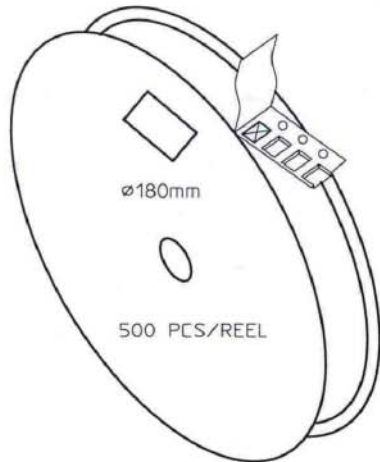

CARRIER TAPE H85-00158  
width=24,00 depth=4.15  
COVER TAPE H85-00159  
width=21.20

### LENGTH OF TAPE:

- Leader section: min 350 mm before component section
- Trailer section: min 40 mm after component section.

Empty part cavities at leader and trailer section of the tape must be sealed with top cover tape.

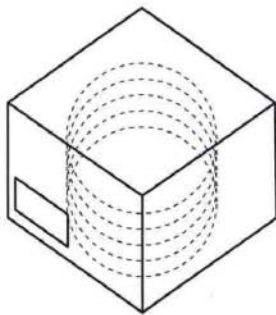

BOX H85-00128                    1 pcs  
(182x182x125)  
- LABEL                            1 pcs/BOX

REEL H85-00160                4 pcs  
(D180, W28)  
- REEL LABEL                    1 pcs/REEL

### MATERIAL

### HANDLINGS

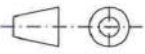
		RATIO	DRWN	160107	PeHa	H
			DGNER			G
PRODUCT H90-OY800-F01P01			CHKD			F
			APPRD			E
			APPRD BY			D
						C
						B
DENOMINATION PACKING FORM						A
			VERSION			MOD/DATE/NAME

### Pulse Finland Oy

Takatie 6  
90440 Kemppele, Finland  
Tel: +358 207 935 500  
Fax: +358 207 935 501  
[www.pulseeng.com/antennas](http://www.pulseeng.com/antennas)



# 2.4 GHz WiFi Antenna

10 x 3.2 x 4.0 mm Ceramic Chip Antenna (0n Ground type, Top surface ground removal area 10.80 x 6.25 mm).  
Pulse Part Number: W3001

## Mechanical Outline

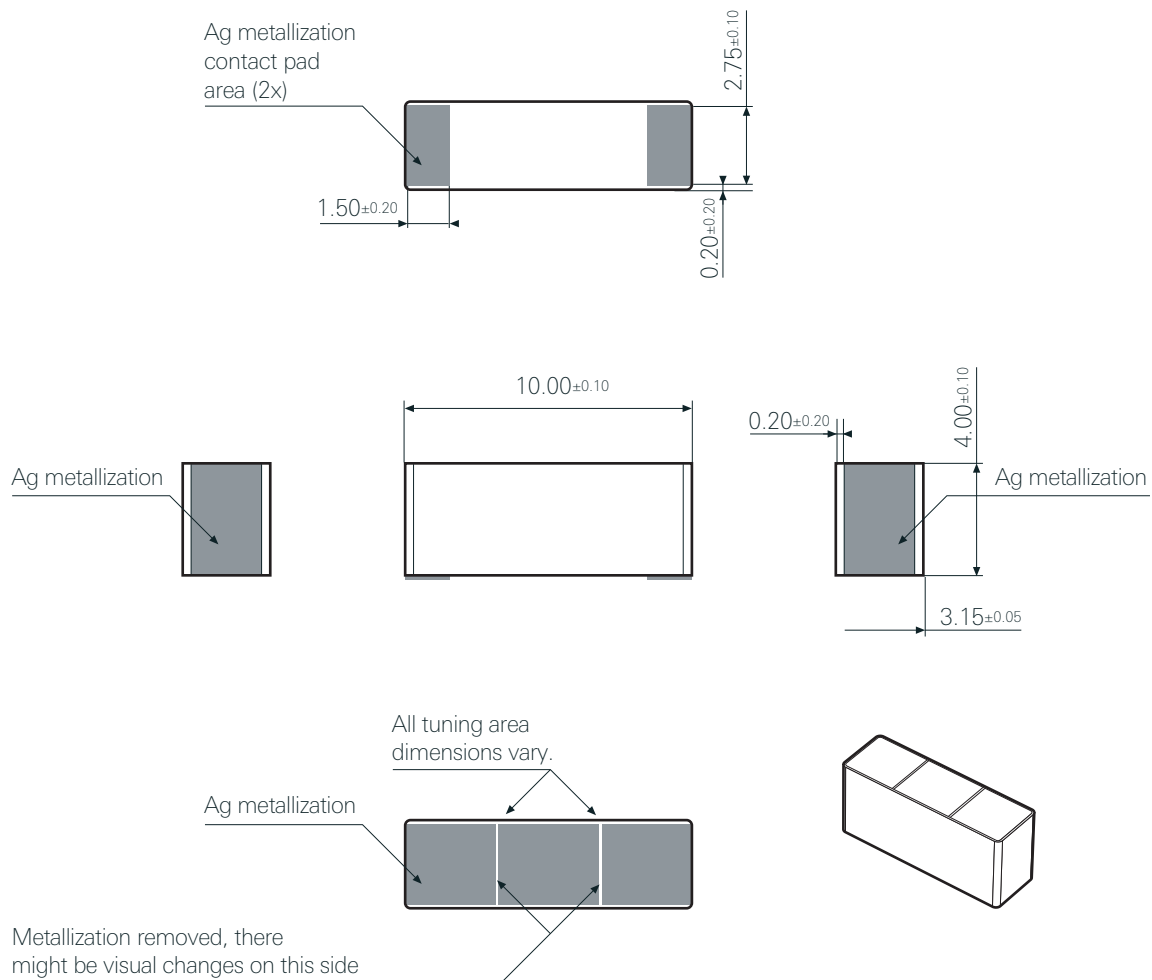

### Pulse Finland Oy

Takatie 6  
90440 Kempele, Finland  
Tel: +358 207 935 500  
Fax: +358 207 935 501  
[www.pulseeng.com/antennas](http://www.pulseeng.com/antennas)