

Harsh Environment Acquisition Terminal (H.E.A.T.) System EVM User's Guide

User's Guide



Literature Number: SLVU468D
June 2011–Revised July 2015

Preface	4
1 Overview	5
2 System Design Guidelines	7
2.1 PCB Details	7
2.1.1 PCB Materials	7
2.1.2 Layout Guidelines and Recommendations	7
2.2 Derating of Integrated Circuits and Passive Components.....	7
3 Hardware Setup	9
3.1 Power-Up Requirements / Sequence.....	10
3.2 ADS1278-HT Connection Options	12
3.3 Voltage Reference	12
3.4 SM470R1B1M-HT Connection Options	12
3.5 ADS1278-HT Analog Inputs	12
3.5.1 Channels 1, 2, and 3: Inclination Circuits	13
3.5.2 Channel 4: Simple Amplifier Using the OPA211-HT.....	13
3.5.3 Channel 5: RTD	13
3.5.4 Channel 6: INA333-HT Instrumentation Amplifier.....	14
3.5.5 Channel 7: THS4521-HT Differential Amplifier	14
3.5.6 Channel 8: Discrete Differential Amplifier Circuit.....	14
4 Software Installation	15
4.1 First Time Installation	15
4.2 Upgrading Existing Installation	15
5 Software Application Overview	16
5.1 Connect / Disconnect	16
5.2 Output / Stop.....	16
5.3 Status Label.....	17
5.4 Temperature Data	17
5.5 Axis Data (Line Charts).....	17
5.6 Four Miscellaneous A/D Channels (Not Visible on GUI).....	17
6 Output File	18
7 Calibration	19
A Establishing Tool Communication Via Terminal	20
A.1 Interpreting Data Frames.....	20
B Hexadecimal	21
Revision D History	22

List of Figures

1-1.	HEATEVM Block Diagram	5
3-1.	HEATEVM ARM7 / ADC Communications	9
3-2.	Analog and Digital Supplies Power-Up Sequence Example.....	11
3-3.	PORRST Signal Power-Up Sequence Example	11
3-4.	Power Down Sequence Example	12
3-5.	Inclination Block Diagram	13
5-1.	HEATEVM Demonstration Screen	16

List of Tables

3-1.	HEATEVM Jumper Configuration for Default Operation.....	9
A-1.	Configuration.....	20
A-2.	Data Frame Example Breakdown	20

This document outlines the basic steps and functions that are required to ensure proper operation of the harsh environment acquisition terminal (H.E.A.T.) system evaluation module (EVM) kit. The HEATEVM is a high-temperature development platform that provides a complete signal-acquisition system for operating temperature environments of 200°C. All of the high-temperature semiconductor devices are qualified and characterized from –55°C to 210°C operation for 1000 hour operating life, thus eliminating the need for expensive up-screening components or using commercial products that have a temperature range beyond the data sheet specifications.

Overview

The HEATEVM platform contains a signal chain consisting of an eight-channel analog input which conditions, digitizes, and processes all of these signals. The EVM has six channels dedicated for temperature, pressure, and accelerometers and two are general-purpose channels (that is, fully differential and single-ended).

Figure 1-1 shows the HEATEVM block diagram. The analog inputs channels comprise six channels dedicated for temperature, pressure, and accelerometers. The OPA211-HT enables accelerometer inputs and all three axis inputs have a buffer amplifier with two poles in a 20-Hz Butterworth filter. Temperature sensing is performed with the THS4521-HT and OPA2333-HT devices. For pressure sensing, a high-impedance bridge instrumentation amplifier is used from the THS4521-HT and OPA2333-HT devices. This circuit realizes a high gain and is ideal for measuring pressure in harsh-environment applications such as down-hole drilling. HEATEVM also has dedicated INA333-HT inputs for pressure transducer coupling.

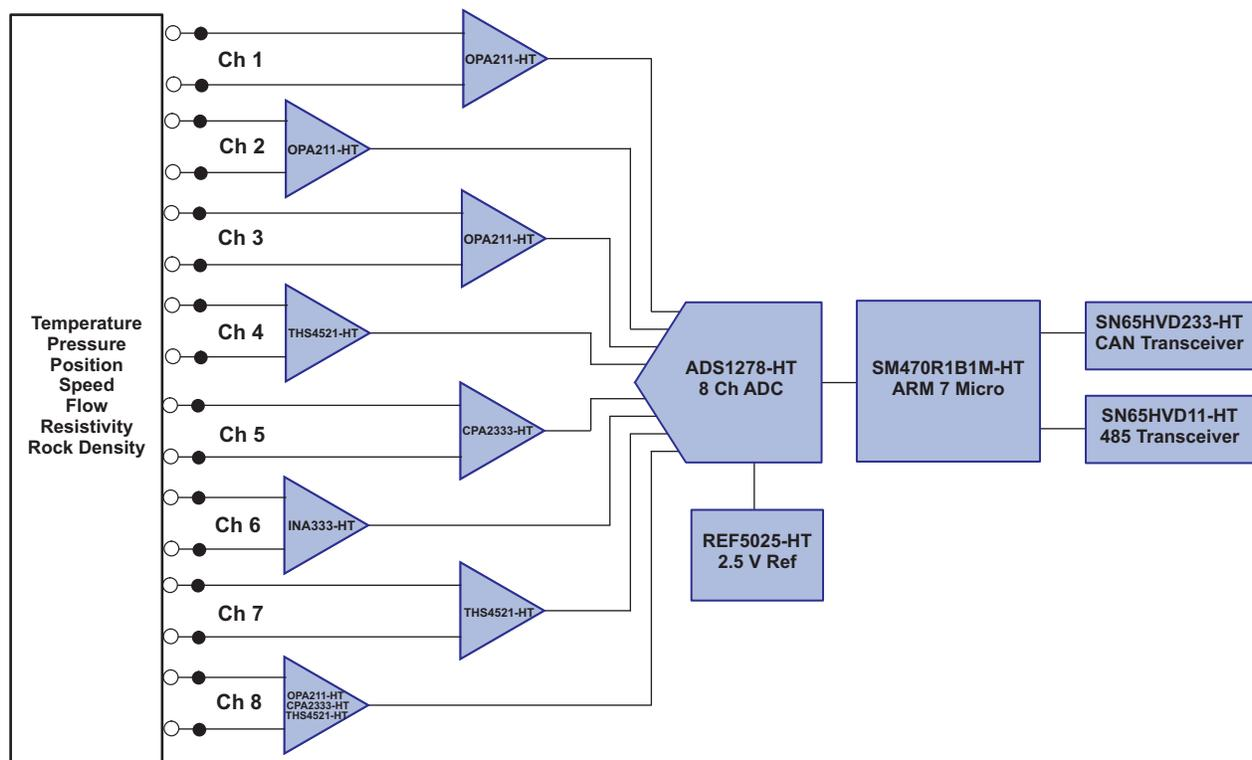

Figure 1-1. HEATEVM Block Diagram

The platform is suited for interfacing with external sensors. The user is expected to interface these sensors by means of user generated cabling. The HEATEVM is pre-loaded with basic firmware layer for the ARM7 microcontroller and source-code is provided in this user's guide. The data acquired by the system can be extracted by the HEATEVM graphical user interface (GUI) software. The GUI performs auto scrolling of data, provides a temperature display, illustrates actual minimum and maximum values, and provides data logging capability for all eight channels. This GUI software is optional, and the user can program their own firmware into the ARM7 microcontroller by means of the JTAG port on the HEATEVM. The optional software runs on a PC terminal and proper serial interfacing is required. The optional software is available to download through:

<http://focus.ti.com/docs/toolsw/folders/print/heatevm.html>

The HEATEVM kit includes one EVM board. All power supply requirements and sequencing need to be provided externally and are outlined in the [Section 3.1](#) section. Refer to the HEATEVM schematic, Gerber, and BOM files for component use and their locations and references from this user's guide. The schematics, Gerbers, and BOM files are available at:

<http://focus.ti.com/docs/toolsw/folders/print/heatevm.html>

System Design Guidelines

2.1 PCB Details

The PCB in the HEATEVM is built from P95 polyimide material and has very good mechanical stability up to temperatures in excess of 210°C.

2.1.1 PCB Materials

The dielectric constant of the polyimide varies between 3.74 and 3.95. With a base layer PCB thickness of 0.093 inches, the eight-layer HEATEVM has a reasonable amount of stiffness to reduce strain on solder joints. For prolonged 210°C elevated testing periods, the polyimide PCB needs to be kept dry and best results are obtained when testing is conducted inside a dry pressure chamber. In general, this is the case with many harsh environment high temperature drilling and logging tools.

The surface copper traces and pads are protected with a nickel-gold finish. The nickel isolates the gold from the copper, while the gold provides for good solder bonding. This type of system prevents the tin found in most solders from forming intermetallic bronze with the copper traces. For short-term exposure at elevated temperatures or temperatures below 98°C, the nickel-gold finish may not be required; however, this added margin safeguards against the intermetallic bronze formations.

2.1.2 Layout Guidelines and Recommendations

Power and ground planes are suggested for optimizing the performance of the ADS1278. Decoupling capacitors should be physically placed as close as possible to the power pins of the ADS1278 and the SN470R1B1M-HT ARM7 microcontroller to minimize capacitance and gain optimized performance. The location of these decoupling capacitors becomes even more critical in high temperature operations since, in addition to the higher costs, larger valued capacitors become the life limiting component in many high-temperature systems. Most capacitor types have falling capacitance values and increasing IR values as the ambient temperature increases which present trade offs when working with capacitors at elevated temperatures. The HEATEVM uses a nominal number of capacitors and value of capacitance.

To reduce temperature effects, 200°C EIA rated capacitors have been used. The COG dielectric has a flat temperature coefficient over temperature and are also referred to as negative-positive-zero (NPO), referring to its value change over temperature. These COG/NPO capacitors are used as decoupling capacitors while 200°C rated tantalum capacitors are used to reduce power supply ripple to the circuit board. To reduce ripple on the voltage reference, a 1- μ F stacked capacitor was used to maintain fast transient response to reduce noise.

2.2 Derating of Integrated Circuits and Passive Components

When designing high-temperature circuits, engineers normally derate the electronic components from the manufacturer's specifications. This is particularly true for the voltage rating of capacitors and the power rating of resistors. As more manufacturers produce electronic components rated for operation at elevated temperatures and engineers gain experience working with these components, the act of derating will become less important.

In any case, the overall rating of an electronic circuit will always be less than the rating of the weakest component in the circuit. Virtually every high temperature application is also a high reliability application. For example, in high reliability applications using all electronic components rated to 200°C and 1000 operating hours, an overall derating of the electronic circuit could be as high as 50°C.

Despite the advancement of computer generated life prediction models, most manufacturers of high temperature control systems require hard numbers in performing accelerated life testing such as highly accelerated life tests (HALT) to find weak links in the design and/or manufacturing process. By starting with manufacturer qualified high temperature electronic components, the design engineer will enjoy a higher percentage of successful HALT testing of new products. Perhaps just as important, is knowing that the high temperature electronic component manufacture will continue to support a high temperature rating through design cycles which within the electronic industry are normally much shorter than the high temperature, high reliability product being designed. For example, an aircraft engine control system can be in production for extended product life-cycles between 20 to 30 years while an electronic component may see a new design cycle every 6 to 10 years.

For high-temperature operation, resistors are chosen for their temperature drift and hydrogen sensitivity. The HEATEVM uses low temperature drift, thin film resistors with a temperature drift of 30 ppm/°C.

Hardware Setup

The HEATEVM, for default operation, should be configured as shown in [Table 3-1](#).

Table 3-1. HEATEVM Jumper Configuration for Default Operation

JUMPER	DEFAULT STATUS	FUNCTION
JP4	Pins 1-2 and pins 3-4, closed	Enabling RTD on board
JP5	Pins 1-2, closed	Connect voltage reference from REF5025-HT to the rest of the board
JP10	Pins 1-2 (bridge is soldered)	Setting FORMAT[2:0] in ADS1278-HT to [001]
JP13	Closed	Setting CLKDIV in ADS1278-HT to 0
JP16	All closed	Connecting SPI signals from SM470R1B1M-HT to ADS1278-HT

The HEATEVM system is controlled by the SM470R1B1M-HT ARM7 microcontroller in conjunction with ADS1278-HT Octal 24-Bit 128KSPS analog-to-digital converter (ADC).

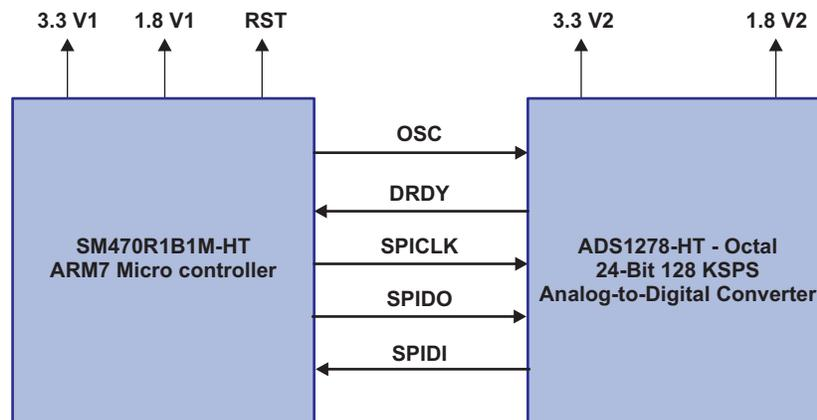

Figure 3-1. HEATEVM ARM7 / ADC Communications

The communications between the SM470R1B1M-HT ARM7 microcontroller and the ADS1278-HT Octal 24-Bit 128KSPS analog-to-digital converter is established using SPI. The ARM7 microcontroller reads the ADS1278-HT data stream using the SPI1 interface on the ARM7. The data ready line (ADSync, Pin 39 of the ADS1278-HT) signals the ARM7 that data is ready for reading on its pin 1 (which is defined as a general I/O pin in software). The three SPI1CLK, SPI1DO, SPI1DI signals from the ARM7 SPI1 are used. The software setup for the SPI1 interface is polarity 1 and phase 0 and the ADS1278-HT data changes on the negative SPI1CLK.

The ADS1278-HT, requires an external clock for operation. In the default case, the ARM7 generates an ADCLK signal from its ECLK, pin 80. ECLK is software programmable and in the source-code included in this manual, ECLK is set to 1.25MHz.

There is no software setup between the ARM7 and the ADS1278-HT as the setup options on the ADS1278-HT set up are defined by the user's choice of format and mode options with the channel enable pins.

The HEATEVM is shipped with preset format pin options on the ADS1278-HT as Format [001] which are set by soldered jumpers on JP10 and establishes a Time-Division Multiplexed bit stream. With this format, the position of each 24 bit ADC reading is fixed in time such that disabling any channel results in a 000000H reading for that channel and all the ADS1278-HT readings are serial out on pin DOUT1. If the user desires to change the format from this default setting, high-temperature solder should be used.

Each of the eight ADS1278-HT channels are enabled by default. To change the default channel enables, solder jumpers at JP12. Each jumper pair is tied to each PWDN channel enable (pins 45 to 52).

The ADS1278 has 4 mode options which can be set by the user by jumpers on JP11. The default setting is Mode[11] for low speed.

The power supply rails have been separated since the power-up sequence differs between the ADC and ARM7 devices.

3.1 Power-Up Requirements / Sequence

The HEATEVM has split power inputs supporting the ARM7 and the ADS1278-HT. Both the ARM7 and the ADS1278-HT have 3.3-V IO and 1.8-V core voltages. Splitting the supply inputs allows for differing power-up sequences for each chip. All voltages reference a common ground. The GND is tied to a ground plane located on layer 2 of the PCB.

All the power for the HEATEVM and the reset signal for the ARM7 (PORRSTN, pin 68 of the ARM7) are on JP2.

Pin 1 on JP2 has a square pad.

- JP2 – Pin 1: 3.3 V (This is the VIO for the ADS1278-HT.)
- JP2 – Pin 2: GND
- JP2 – Pin 3: 1.8 V (This is the ADS1278-HT core voltage.)
- JP2 – Pin 4: GND
- JP2 – Pin 5: 3.3 V (This is the VIO for the ARM7.)
- JP2 – Pin 6: GND
- JP2 – Pin 7: PORRSTN (reset signal of the ARM7)
- JP2 – Pin 8: 1.8 V (This is the ARM7 core voltage.)
- JP2 – Pin 9: GND
- JP2 – Pin 10: NC
- JP2 – Pin 11: 5 V (analog voltage)
- JP2 – Pin 12: GND

The SM470R1B1M-HT (document [SPNS155](#)), requires that the 3.3-V IO voltage is greater than 1.1 V before the 1.8-V core voltage is greater than 0.6 V. Specific timing requirements for the PORRSTN input are also outlined in [SPNS155](#). For detailed information on the power-up sequence of the ADS1278-HT, see [SBAS447](#). In general, core voltage should reach a nominal 1 V before the IO voltage reaches 1 V. The analog voltage must be last, with a nominal 3 V triggering an internal reset to the chip.

An example of a power sequence is shown in [Figure 3-2](#), [Figure 3-3](#), and [Figure 3-4](#). In summary, the 1.8-V analog supply must be powered up before the 1.8-V digital supply. The analog and digital 3.3-V supplies can be powered up at the same time. The PORRSTN signal must go high after all the power supplies are stable. For power down, the PORRSTN signal must go low before all the power supplies go low.

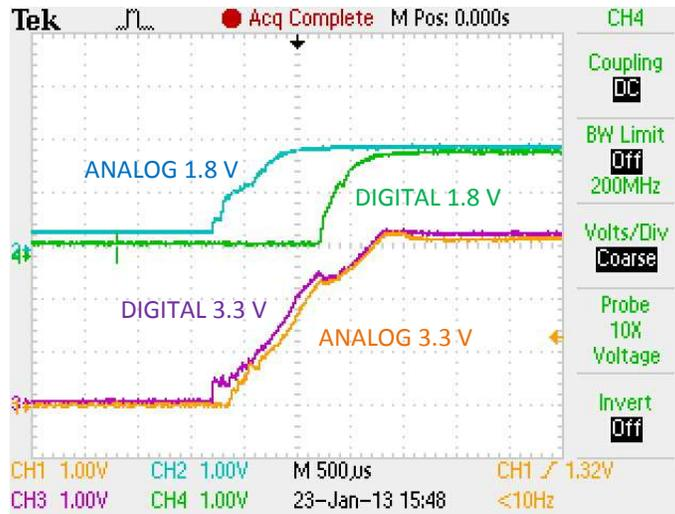

Figure 3-2. Analog and Digital Supplies Power-Up Sequence Example

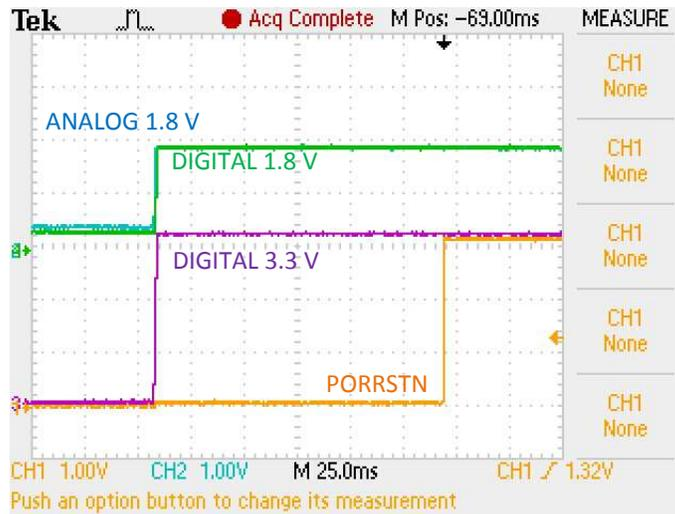

Figure 3-3. PORRSTN Signal Power-Up Sequence Example

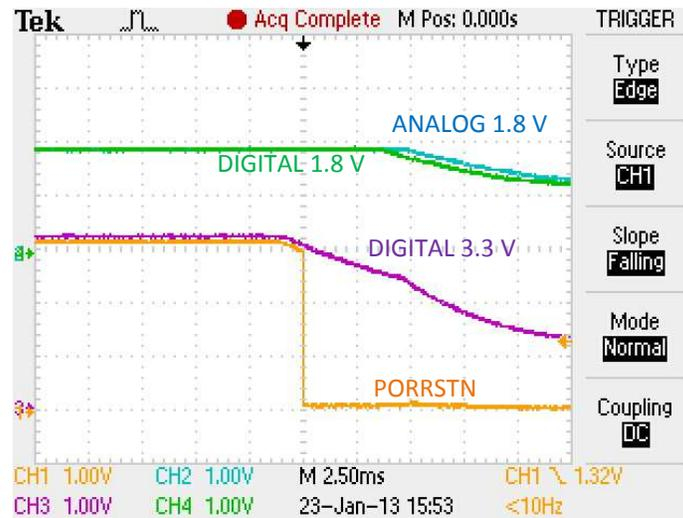

Figure 3-4. Power Down Sequence Example

3.2 ADS1278-HT Connection Options

The ADS1278-HT has a several pin assigned options. To provide the user with maximum flexibility, the following jumper blocks connected to the following pin assignment pins of the ADS1278-HT. In all cases, a jumper installed results in a 'low' setting.

- JP10 pins set the AD format options
- JP11 pins set the AD mode options
- JP12 pins enable the AD channels

For running the demonstration board at 200°C, some jumpers are hardwired. The user can change these setting by removing or adding a solders jumper. These jumpers are of the same board layout as the other jumper blocks, as such all the hardwired jumpers can be replaced with jumper blocks if so desired.

- JP13 is jumper to set CLKDIV to 'low' input.
- JP16 are jumpers to interface the ADS1278 to SM470R1B1M (ARM7). The ADS1278 is connecting to the ARM7 as a SPI device.

3.3 Voltage Reference

The REF5025-HT is supplied as the on board voltage reference. The REF5025-HT has a nominal voltage of 2.5 V. The on board voltage reference can be replaced by placing a jumper between pins 2 and 3 of JP5 and applying a new external voltage to JP6 with pin 1 as the positive voltage and pin 2 as GND.

3.4 SM470R1B1M-HT Connection Options

The TI ARM7 is in circuit programmable using either the 20-pin JP20 or the 14-pin JP19. Because the demonstration board can be heated to 200°C, a standard gold plated pin header is used in both cases. The user must check the pin orientation against the circuit layout. Looking at the circuit board, with the ARM7 chip toward the user's left hand, pin 1 on JP20 and JP19 is on the top left side of each pin header. A 1.8-V oscillator is strongly recommended to drive the SM470R1B1M-HT as indicated in the data sheet.

3.5 ADS1278-HT Analog Inputs

The ADS1278-HT has eight differential inputs to its eight parallel 24-bit analog to digital converters. The HEATEVM provides input to all eight channels using the analog circuits described below.

3.5.1 Channels 1, 2, and 3: Inclination Circuits

Measuring inclination (or tilt) is a common measurement in the harsh-environment down-hole drilling industry. For example, most drilling tools measure 3-axis inclination to determine what the orientation of the drill bit is. The first 3 channels of the ADS1278-HT are examples of a filtered buffer/amplifier for use in measuring the 3-axis inclination signals.

The HEATEVM inclination signals are filtered in an active two pole Butterworth filter using the using the OPA211-HT. Low Pass filters of 20 Hz to reduce 60-Hz noise picked up by the cable running between the HEATEVM (inside an oven) and the inclination sensor board located outside of the oven.

When the cable is not connected, a precision resistor network provided a fixed DC voltage to the three inclination inputs on the HEATEVM. This allows operation without the inclination circuit.

An RTD circuit can be added to the HEATEVM to provide a differential signal to the THS4521-HT and will need to use the REF5025-HT to bias the circuit. The OPA211-HT can be used to buffer the REF5025-HT to the circuit. The REF5025-HT will also provide the reference voltage to the ADS1278-HT.

Figure 3-5 shows the block diagram of the inclination circuits.

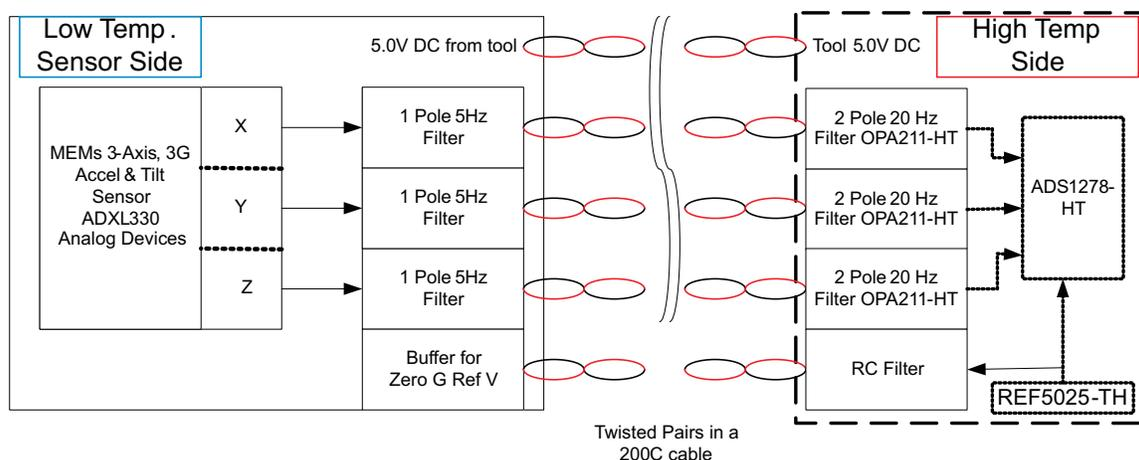

Figure 3-5. Inclination Block Diagram

3.5.2 Channel 4: Simple Amplifier Using the OPA211-HT

A simple amplifier circuit using the OPA211-HT with a fixed gain of -10 . The user can supply an input signal to pin 7 of JP26. The amplifier has a 1.25-V reference at the +in pin. TP8 is a test point for monitoring the amplifiers output.

3.5.3 Channel 5: RTD

Channel 5 of the ADS1278-HT is setup to measure board temperature using an onboard 1000- Ω RTD located at JP4. An external RTD can be used by removing the onboard RTD and the two jumpers on JP4 and replacing them with the standard 4-wire RTD.

In Well Logging systems, it is typical to detect relative temperature changes of 0.001°C so the 24-bit accuracy associated with the ADS1278-HT is necessary in order to facilitate this measurement.

The RTD has a nearly flat response of $3.85\Omega/^{\circ}\text{C}$ starting with a nominal $1000\ \Omega$ at 0°C . At 20°C room temperature, the RTD is about $1077\ \Omega$ and about $1385\ \Omega$ at 100°C . The use of $3.85\ \Omega$ per degree will create about 1 to 2°C error at 200°C . Use of a typical second-degree polynomial curve fit will improve this measurement while also correcting for small circuit offsets. However, for demonstration purposes these small errors are negligible for a board mounted sensor and no system calibration unique to each board was performed.

The RTD measurement circuit uses the voltage reference (U6, REF5025-HT) to create a bias current for a 1000- Ω RTD. The reference voltage is 2.5 V. This voltage is buffered (U7, OPA2333 “B”) with a resistor divider network of R25 and R26. The resistor divider is used to reduce the reference voltage to 0.5 V. This voltage is used to create a DC bias to the positive input to +INA of U7.

The “A” amplifier of U7 (OPA2333-HT) has the 1000- Ω RTD in its feedback. This amplifier holds the voltage across R24 to the bias value of 0.5 V. This sets the current in the feedback RTD resistor to $I_{RTD} = 0.5/R24$. As R24 is a fixed, high precision resistor equal to 1000 Ω , $I_{RTD} = 0.005$ A and the voltage across the RTD at 0°C is 0.5 V. As the temperature increases, the voltage across the RTD increases at 0.0173 V/°C.

U8 (THS4521) is used to amplify the differential signal across the RTD. The gain of U8 is fixed by $R19/R18 = R20/R21 = 2$. At 0°C, the differential output is $2 \times 0.5 = 1$ V. The output is then subject to change over temperature by about 0.0346 V/°C.

The differential amplifier, U8 (THS4521-HT) has its VOCM pin either as an open circuit or tied back to the ADS1278, VCOM pin using jumper block JP9. In the case of the RTD circuit, a zero temperature creates a differential voltage of 0.5 V, so an offset is accounted for in the display software

3.5.4 Channel 6: INA333-HT Instrumentation Amplifier

Channel 6 of the ADS1278-HT is setup as a differential channel and is a user illustrated circuit based on the INA333-HT and pins 6 and 5 of JP26. R42 is used to set the gain value of the INA333-HT. The gain is calculated by $\text{Gain} = 1 + (100k/R42)$, for $R42 = 100 \Omega$ the gain is 1001. A simple RC filter is placed between the amplifier and the ADS1278. Test point TP10 is available to monitor the amplifiers output.

3.5.5 Channel 7: THS4521-HT Differential Amplifier

Channel 6 of the ADS1278-HT is setup as a differential channel and a differential amplifier circuit for user input signals based on the THS4521-HT. Full access to the THS4521 input pins are available at JP26, pins 1-4. The amplifier has a fix gain of 1 set by $R47/R48$ and $R51/R52$. This amplifier is operating from the 3.3-V supply.

3.5.6 Channel 8: Discrete Differential Amplifier Circuit

Channel 8 of the ADS1278-HT is setup as a differential channel and is left for the users discretion. It can be used for simulating the measurement of a standard 4-wire bridge type pressure transducer. In this case, the pressure transducer cable would be connected to JP8. U10 (OPA211-HT) is used to bias the bridge circuit to 2.5 V. The bridge differential voltage is input is buffered by U11 (OPA2333-HT). The OPA2333-HT is precision amplifier well suited for this type of application. U14 (THS4521-HT) is used to amplify the buffered signals coming from U11. The gain of this circuit is about 501 set by the resistor pairs $R54/R53$ and $R56/R55$. A small differential RC filter is in between the outputs of U14 and the ADS1278.

Software Installation

The software installation for the HEATEVM system is broken into two sections: *First Time Installation* and *Upgrading Existing Installation*.

4.1 First Time Installation

The software installation has several prerequisites that may or may not be already installed on your PC. If the software is already installed you can safely proceed to the next step.

Prerequisites:

1. Microsoft® .NET Framework 3.5 sp1
<http://www.microsoft.com/downloads/en/details.aspx?FamilyId=333325fd-ae52-4e35-b531-508d977d32a6>
2. Microsoft Charting
This can be found in the in the 3rd Party folder of the program files: MSChart.exe
OR
Download from:
<http://www.microsoft.com/downloads/en/details.aspx?FamilyId=130F7986-BF49-4FE5-9CA8-910AE6EA442C>

Installation:

1. Install Microsoft .NET Framework 3.5 sp1 and follow instructions.
2. Install Microsoft Charting and follow instructions.
3. Copy the program folder onto the local computer. The software can run from the desktop or can be placed in Program Files along with other software.

4.2 Upgrading Existing Installation

When upgrading to a new version there is only one file that could be important to preserve between versions. It is located in the program folder and is the TIDemo.exe.config file. This file, as you'll read later, possibly contains calibration information regarding your actual hardware. Other files can be simply copied over or removed and replaced with the updated software version.

Software Application Overview

The HEATEVM demonstration screen (Figure 5-1) illustrates what will be seen on the user terminal interface.

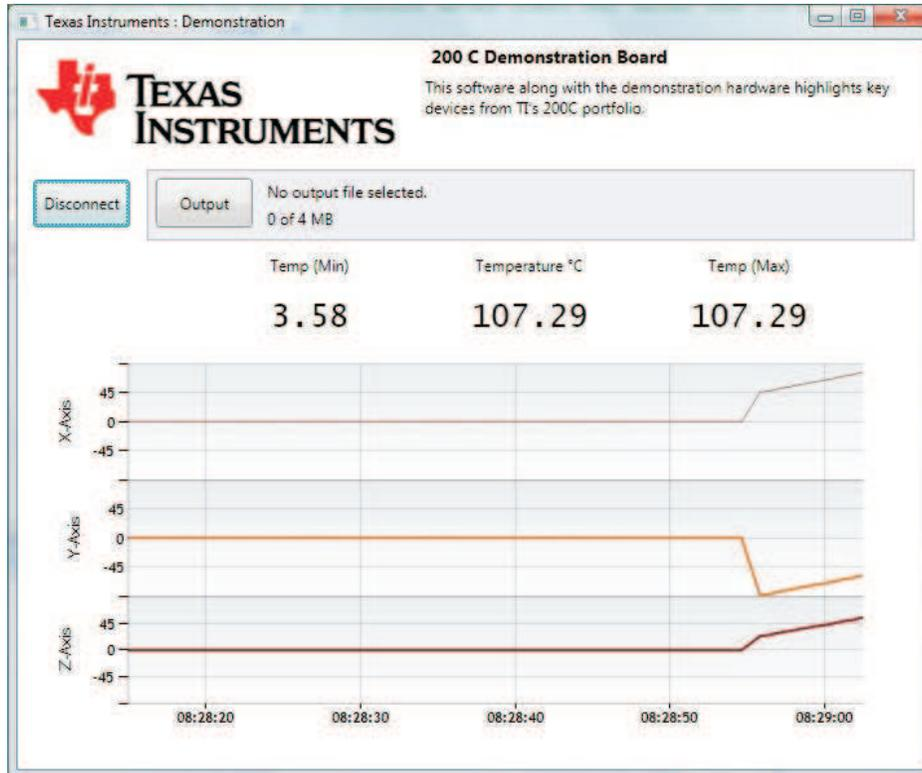

Figure 5-1. HEATEVM Demonstration Screen

5.1 Connect / Disconnect

The upper left most button is labeled “Connect” or “Disconnect” depending on whether or not you’re currently connected and receiving data from the electronics.

The HEATEVM uses serial port (COM) communication. This is frequently provided by USB to Serial connectors in recent computers. If the computer has only a single COM port installed the Connect button will automatically try to connect to that port. If there are more than one COM port available a window will pop up allowing you to choose which COM port is connected to the TI Demo hardware.

5.2 Output / Stop

This button is labeled “Output” or “Stop” depending on whether or not the real time data is being saved to a file. The output button allows the saving of the real time data into a file. By selecting the output file all data from that point begins to be saved. Data that was received prior to setting an output file is not retroactively saved.

5.3 Status Label

The file name label below and to the right of the Output button is a status label, here it shows “0 of 4 MB”. When saving data to an output file this counter will demonstrate how much raw binary data is being saved. This correlates to the future version of a memory demonstration where the 200 C memory will be 4 MB.

It will also report errors if it cannot successfully interpret the data frame being sent from the electronics or if the electronics themselves report an error.

1. Electronics error, if the analog to digital circuit is not responding to the processor it will flash in red:
“!ADC communication failure”
2. Communications error, if the software is unable to interpret the data frame:
“Cannot parse: [index, value]”

There are log files saved with non-critical exceptions but can be useful in identifying issues.

5.4 Temperature Data

Low, max, and current temperatures are displayed here. These are reported from a built-in RTD on the board. See calibration section on how to calibrate the values.

5.5 Axis Data (Line Charts)

The initial demonstration of the Demo Board is to have an accelerometer transmitting data from all three axes (X, Y, Z). These values are demonstrated here in degrees. See calibration section for how to calibrate the values.

5.6 Four Miscellaneous A/D Channels (Not Visible on GUI)

There are four additional channels in the eight channel A/D converter that are not displayed but are still recorded in the output file. These values do not have a calibration applied to them but the data is accessible through Excel® or other comma separated values (csv) software. See the section on the output file.

Output File

The output file contains time data, 4 calibrated channels, and 4 non-calibrated channels in a comma separated file. The 4 calibrated correspond to the 4 displayed data in the software: temperature, x-axis, y-axis, and z-axis.

```
# TI 200C Demonstration Output File
# Below is a CSV file of the data seen while running the demonstration
# Recording started: 4/19/2011 8:55:02 AM
Time          Temp (F)  X Axis  Y Axis  Z Axis  AD4      AD6      AD7      AD8
55:02.70      185.97   -79.27  -34.21  78.29   -8388608 -8388608 -8388608 -8388608
55:02.90      189.55   -78.2   -33.14  79.36   -8388608 -8388608 -8388608 -8388608
55:03.20      193.12   -77.13  -32.06  80.44   -8388608 -8388608 -8388608 -8388608
```

The other four channels can be raw data as well if the calibration is changed to pass through the value rather than modifying it. See [Chapter 7](#) section.

The four non-calibrated channels cannot be calibrated via the demonstration software.

Calibration

Calibration applies coefficients and functions to obtain an accurate representation of a sensor's measurement. To do this to the analog to digital converter the coefficients can be entered into a text file prior to running the software.

Within the program's folders there is a file "TIDemo.exe.config". Open this file with a text editor such as Notepad and you'll see something similar to below.

```
<?xml version="1.0" encoding="utf-8" ?>
<configuration>
  <appSettings>
    <!-- To fake serial data for GUI testing make the value="Fake" below -->
    <add key="COMPort" value="Fake" />

    <!-- To allow the chart axis to show all possible values (24bit int) rather than
    the axis +/-90 degrees set value="True" below. -->
    <add key="FullRange" value="False" />

    <!-- Temp Coefficients Match Cal Function y(x) = a*x+b -->
    <add key="TempCoeff1" value="0.0000357632473028550992430112654229" />
    <add key="TempCoeff2" value="0" />

    <!-- Axis Coefficients Match Cal Function y(x) = a*x+b -->
    <add key="AxisCoeff1" value="0.0000107288360595703125" />
    <add key="AxisCoeff2" value="0" />

  </appSettings>
</configuration>
```

The TempCoeff1 and TempCoeff2 correspond to the a and b variables of the point slope function $y(x) = a x x + b$ respectively. When the AD counts (x) are evaluated the result is the RTD's temperature.

The AxisCoeff1 and AxisCoeff2 do the same thing for the axes calibration into degrees.

By changing Coeff1 value to 1 and Coeff2 value to 0 for both Temp and Axis the resulting output will be the raw AD data just like the other 4 channels which have no calibrations applied.

If this is done, or any calibration applied that would result in a range greater than 90, the "FullRange" value can be set to "True" so that the data can still be visible in the line charts.

Changes to this file are only interpreted at the application start. So if a change has been made here the software must be closed and reopened to recognize it.

Establishing Tool Communication Via Terminal

The tool data can be seen and interpreted directly without using the demonstration software.

Close all software that might be using the same port the electronics are connected to. Start your terminal program with the following settings:

Table A-1. Configuration

Connect using:	Installed COM Port tool is attached to
Bits per second:	576000
Data bits:	8
Parity:	None
Stop bits:	1
Flow control:	None

If the electronics are currently logging information its output should appear almost immediately.

A.1 Interpreting Data Frames

Data frames are visible while communicating with the tool in a terminal.

Terminal output example:

9E58BE, BD8D85, 800071, BD07F2, C9D0CE, 7FFDE9, 80005C, 80006C

The frame is a series of numeric values in hexadecimal format separated by commas. The values represent A/D counts. Converting these A/D counts into sensor data requires calibration as described above. Accessing the data in this manner removes any limitations on interpretation.

Terminal error output example:

!Error message here

Any data frame that starts with an exclamation point is an error frame and the cause of the error is contained in the text following it.

Table A-2. Data Frame Example Breakdown

9E58BE, BD8D85, 800071, BD07F2, C9D0CE, 7FFDE9, 80005C, 80006C	
9E58BE	24-bit channel (x-axis)
BD8D85	24-bit channel (x-axis)
800071	24-bit channel (x-axis)
BD07F2	24-bit channel (spare)
C9D0CE	24-bit channel (temperature)
7FFDE9	24-bit channel (spare)
80005C	24-bit channel (spare)
80006C	24-bit channel (spare)

Hexadecimal

Hexadecimal is the number format output by the electronics. For quick reference hexadecimal (base 16) is counted as follows with decimal (base 10).

Decimal (Base 10)

0	1	2	3	4	5	6	7	8	9	10	11	12	13	14	15	16	17	18	19	20	...	24	25	26	27
0	1	2	3	4	5	6	7	8	9	A	B	C	D	E	F	10	11	12	13	14	...	18	19	1A	1B

Hexadecimal (Base 16)

Revision D History

Changes from C Revision (October 2012) to D Revision	Page
• Added jumper configuration for default operation.....	9
• Added power sequence example for the board.....	10

NOTE: Page numbers for previous revisions may differ from page numbers in the current version.

STANDARD TERMS AND CONDITIONS FOR EVALUATION MODULES

1. *Delivery:* TI delivers TI evaluation boards, kits, or modules, including any accompanying demonstration software, components, or documentation (collectively, an "EVM" or "EVMs") to the User ("User") in accordance with the terms and conditions set forth herein. Acceptance of the EVM is expressly subject to the following terms and conditions.
 - 1.1 EVMs are intended solely for product or software developers for use in a research and development setting to facilitate feasibility evaluation, experimentation, or scientific analysis of TI semiconductor products. EVMs have no direct function and are not finished products. EVMs shall not be directly or indirectly assembled as a part or subassembly in any finished product. For clarification, any software or software tools provided with the EVM ("Software") shall not be subject to the terms and conditions set forth herein but rather shall be subject to the applicable terms and conditions that accompany such Software
 - 1.2 EVMs are not intended for consumer or household use. EVMs may not be sold, sublicensed, leased, rented, loaned, assigned, or otherwise distributed for commercial purposes by Users, in whole or in part, or used in any finished product or production system.
2. *Limited Warranty and Related Remedies/Disclaimers:*
 - 2.1 These terms and conditions do not apply to Software. The warranty, if any, for Software is covered in the applicable Software License Agreement.
 - 2.2 TI warrants that the TI EVM will conform to TI's published specifications for ninety (90) days after the date TI delivers such EVM to User. Notwithstanding the foregoing, TI shall not be liable for any defects that are caused by neglect, misuse or mistreatment by an entity other than TI, including improper installation or testing, or for any EVMs that have been altered or modified in any way by an entity other than TI. Moreover, TI shall not be liable for any defects that result from User's design, specifications or instructions for such EVMs. Testing and other quality control techniques are used to the extent TI deems necessary or as mandated by government requirements. TI does not test all parameters of each EVM.
 - 2.3 If any EVM fails to conform to the warranty set forth above, TI's sole liability shall be at its option to repair or replace such EVM, or credit User's account for such EVM. TI's liability under this warranty shall be limited to EVMs that are returned during the warranty period to the address designated by TI and that are determined by TI not to conform to such warranty. If TI elects to repair or replace such EVM, TI shall have a reasonable time to repair such EVM or provide replacements. Repaired EVMs shall be warranted for the remainder of the original warranty period. Replaced EVMs shall be warranted for a new full ninety (90) day warranty period.
3. *Regulatory Notices:*
 - 3.1 *United States*
 - 3.1.1 *Notice applicable to EVMs not FCC-Approved:*

This kit is designed to allow product developers to evaluate electronic components, circuitry, or software associated with the kit to determine whether to incorporate such items in a finished product and software developers to write software applications for use with the end product. This kit is not a finished product and when assembled may not be resold or otherwise marketed unless all required FCC equipment authorizations are first obtained. Operation is subject to the condition that this product not cause harmful interference to licensed radio stations and that this product accept harmful interference. Unless the assembled kit is designed to operate under part 15, part 18 or part 95 of this chapter, the operator of the kit must operate under the authority of an FCC license holder or must secure an experimental authorization under part 5 of this chapter.
 - 3.1.2 *For EVMs annotated as FCC – FEDERAL COMMUNICATIONS COMMISSION Part 15 Compliant:*

CAUTION

This device complies with part 15 of the FCC Rules. Operation is subject to the following two conditions: (1) This device may not cause harmful interference, and (2) this device must accept any interference received, including interference that may cause undesired operation.

Changes or modifications not expressly approved by the party responsible for compliance could void the user's authority to operate the equipment.

FCC Interference Statement for Class A EVM devices

NOTE: This equipment has been tested and found to comply with the limits for a Class A digital device, pursuant to part 15 of the FCC Rules. These limits are designed to provide reasonable protection against harmful interference when the equipment is operated in a commercial environment. This equipment generates, uses, and can radiate radio frequency energy and, if not installed and used in accordance with the instruction manual, may cause harmful interference to radio communications. Operation of this equipment in a residential area is likely to cause harmful interference in which case the user will be required to correct the interference at his own expense.

FCC Interference Statement for Class B EVM devices

NOTE: This equipment has been tested and found to comply with the limits for a Class B digital device, pursuant to part 15 of the FCC Rules. These limits are designed to provide reasonable protection against harmful interference in a residential installation. This equipment generates, uses and can radiate radio frequency energy and, if not installed and used in accordance with the instructions, may cause harmful interference to radio communications. However, there is no guarantee that interference will not occur in a particular installation. If this equipment does cause harmful interference to radio or television reception, which can be determined by turning the equipment off and on, the user is encouraged to try to correct the interference by one or more of the following measures:

- Reorient or relocate the receiving antenna.
- Increase the separation between the equipment and receiver.
- Connect the equipment into an outlet on a circuit different from that to which the receiver is connected.
- Consult the dealer or an experienced radio/TV technician for help.

3.2 Canada

3.2.1 For EVMs issued with an Industry Canada Certificate of Conformance to RSS-210

Concerning EVMs Including Radio Transmitters:

This device complies with Industry Canada license-exempt RSS standard(s). Operation is subject to the following two conditions: (1) this device may not cause interference, and (2) this device must accept any interference, including interference that may cause undesired operation of the device.

Concernant les EVMs avec appareils radio:

Le présent appareil est conforme aux CNR d'Industrie Canada applicables aux appareils radio exempts de licence. L'exploitation est autorisée aux deux conditions suivantes: (1) l'appareil ne doit pas produire de brouillage, et (2) l'utilisateur de l'appareil doit accepter tout brouillage radioélectrique subi, même si le brouillage est susceptible d'en compromettre le fonctionnement.

Concerning EVMs Including Detachable Antennas:

Under Industry Canada regulations, this radio transmitter may only operate using an antenna of a type and maximum (or lesser) gain approved for the transmitter by Industry Canada. To reduce potential radio interference to other users, the antenna type and its gain should be so chosen that the equivalent isotropically radiated power (e.i.r.p.) is not more than that necessary for successful communication. This radio transmitter has been approved by Industry Canada to operate with the antenna types listed in the user guide with the maximum permissible gain and required antenna impedance for each antenna type indicated. Antenna types not included in this list, having a gain greater than the maximum gain indicated for that type, are strictly prohibited for use with this device.

Concernant les EVMs avec antennes détachables

Conformément à la réglementation d'Industrie Canada, le présent émetteur radio peut fonctionner avec une antenne d'un type et d'un gain maximal (ou inférieur) approuvé pour l'émetteur par Industrie Canada. Dans le but de réduire les risques de brouillage radioélectrique à l'intention des autres utilisateurs, il faut choisir le type d'antenne et son gain de sorte que la puissance isotrope rayonnée équivalente (p.i.r.e.) ne dépasse pas l'intensité nécessaire à l'établissement d'une communication satisfaisante. Le présent émetteur radio a été approuvé par Industrie Canada pour fonctionner avec les types d'antenne énumérés dans le manuel d'usage et ayant un gain admissible maximal et l'impédance requise pour chaque type d'antenne. Les types d'antenne non inclus dans cette liste, ou dont le gain est supérieur au gain maximal indiqué, sont strictement interdits pour l'exploitation de l'émetteur.

3.3 Japan

3.3.1 *Notice for EVMs delivered in Japan:* Please see http://www.tij.co.jp/lstds/ti_ja/general/eStore/notice_01.page 日本国内に輸入される評価用キット、ボードについては、次のところをご覧ください。
http://www.tij.co.jp/lstds/ti_ja/general/eStore/notice_01.page

3.3.2 *Notice for Users of EVMs Considered "Radio Frequency Products" in Japan:* EVMs entering Japan may not be certified by TI as conforming to Technical Regulations of Radio Law of Japan.

If User uses EVMs in Japan, not certified to Technical Regulations of Radio Law of Japan, User is required by Radio Law of Japan to follow the instructions below with respect to EVMs:

1. Use EVMs in a shielded room or any other test facility as defined in the notification #173 issued by Ministry of Internal Affairs and Communications on March 28, 2006, based on Sub-section 1.1 of Article 6 of the Ministry's Rule for Enforcement of Radio Law of Japan,
2. Use EVMs only after User obtains the license of Test Radio Station as provided in Radio Law of Japan with respect to EVMs, or
3. Use of EVMs only after User obtains the Technical Regulations Conformity Certification as provided in Radio Law of Japan with respect to EVMs. Also, do not transfer EVMs, unless User gives the same notice above to the transferee. Please note that if User does not follow the instructions above, User will be subject to penalties of Radio Law of Japan.

【無線電波を送信する製品の開発キットをお使いになる際の注意事項】 開発キットの中には技術基準適合証明を受けていないものがあります。技術適合証明を受けていないものご使用に際しては、電波法遵守のため、以下のいずれかの措置を取っていただく必要がありますのでご注意ください。

1. 電波法施行規則第6条第1項第1号に基づく平成18年3月28日総務省告示第173号で定められた電波暗室等の試験設備でご使用いただく。
2. 実験局の免許を取得後ご使用いただく。
3. 技術基準適合証明を取得後ご使用いただく。

なお、本製品は、上記の「ご使用にあたっての注意」を譲渡先、移転先に通知しない限り、譲渡、移転できないものとします。

上記を遵守頂けない場合は、電波法の罰則が適用される可能性があることをご留意ください。日本テキサス・インスツルメンツ株式会社
東京都新宿区西新宿 6 丁目 2 4 番 1 号
西新宿三井ビル

3.3.3 *Notice for EVMs for Power Line Communication:* Please see http://www.tij.co.jp/llds/ti_ja/general/eStore/notice_02.page
電力線搬送波通信についての開発キットをお使いになる際の注意事項については、次のところをご覧ください。http://www.tij.co.jp/llds/ti_ja/general/eStore/notice_02.page

4 *EVM Use Restrictions and Warnings:*

- 4.1 EVMS ARE NOT FOR USE IN FUNCTIONAL SAFETY AND/OR SAFETY CRITICAL EVALUATIONS, INCLUDING BUT NOT LIMITED TO EVALUATIONS OF LIFE SUPPORT APPLICATIONS.
- 4.2 User must read and apply the user guide and other available documentation provided by TI regarding the EVM prior to handling or using the EVM, including without limitation any warning or restriction notices. The notices contain important safety information related to, for example, temperatures and voltages.
- 4.3 *Safety-Related Warnings and Restrictions:*
 - 4.3.1 User shall operate the EVM within TI's recommended specifications and environmental considerations stated in the user guide, other available documentation provided by TI, and any other applicable requirements and employ reasonable and customary safeguards. Exceeding the specified performance ratings and specifications (including but not limited to input and output voltage, current, power, and environmental ranges) for the EVM may cause personal injury or death, or property damage. If there are questions concerning performance ratings and specifications, User should contact a TI field representative prior to connecting interface electronics including input power and intended loads. Any loads applied outside of the specified output range may also result in unintended and/or inaccurate operation and/or possible permanent damage to the EVM and/or interface electronics. Please consult the EVM user guide prior to connecting any load to the EVM output. If there is uncertainty as to the load specification, please contact a TI field representative. During normal operation, even with the inputs and outputs kept within the specified allowable ranges, some circuit components may have elevated case temperatures. These components include but are not limited to linear regulators, switching transistors, pass transistors, current sense resistors, and heat sinks, which can be identified using the information in the associated documentation. When working with the EVM, please be aware that the EVM may become very warm.
 - 4.3.2 EVMs are intended solely for use by technically qualified, professional electronics experts who are familiar with the dangers and application risks associated with handling electrical mechanical components, systems, and subsystems. User assumes all responsibility and liability for proper and safe handling and use of the EVM by User or its employees, affiliates, contractors or designees. User assumes all responsibility and liability to ensure that any interfaces (electronic and/or mechanical) between the EVM and any human body are designed with suitable isolation and means to safely limit accessible leakage currents to minimize the risk of electrical shock hazard. User assumes all responsibility and liability for any improper or unsafe handling or use of the EVM by User or its employees, affiliates, contractors or designees.
- 4.4 User assumes all responsibility and liability to determine whether the EVM is subject to any applicable international, federal, state, or local laws and regulations related to User's handling and use of the EVM and, if applicable, User assumes all responsibility and liability for compliance in all respects with such laws and regulations. User assumes all responsibility and liability for proper disposal and recycling of the EVM consistent with all applicable international, federal, state, and local requirements.

5. *Accuracy of Information:* To the extent TI provides information on the availability and function of EVMs, TI attempts to be as accurate as possible. However, TI does not warrant the accuracy of EVM descriptions, EVM availability or other information on its websites as accurate, complete, reliable, current, or error-free.

6. *Disclaimers:*

6.1 EXCEPT AS SET FORTH ABOVE, EVMS AND ANY WRITTEN DESIGN MATERIALS PROVIDED WITH THE EVM (AND THE DESIGN OF THE EVM ITSELF) ARE PROVIDED "AS IS" AND "WITH ALL FAULTS." TI DISCLAIMS ALL OTHER WARRANTIES, EXPRESS OR IMPLIED, REGARDING SUCH ITEMS, INCLUDING BUT NOT LIMITED TO ANY IMPLIED WARRANTIES OF MERCHANTABILITY OR FITNESS FOR A PARTICULAR PURPOSE OR NON-INFRINGEMENT OF ANY THIRD PARTY PATENTS, COPYRIGHTS, TRADE SECRETS OR OTHER INTELLECTUAL PROPERTY RIGHTS.

6.2 EXCEPT FOR THE LIMITED RIGHT TO USE THE EVM SET FORTH HEREIN, NOTHING IN THESE TERMS AND CONDITIONS SHALL BE CONSTRUED AS GRANTING OR CONFERRING ANY RIGHTS BY LICENSE, PATENT, OR ANY OTHER INDUSTRIAL OR INTELLECTUAL PROPERTY RIGHT OF TI, ITS SUPPLIERS/LICENSORS OR ANY OTHER THIRD PARTY, TO USE THE EVM IN ANY FINISHED END-USER OR READY-TO-USE FINAL PRODUCT, OR FOR ANY INVENTION, DISCOVERY OR IMPROVEMENT MADE, CONCEIVED OR ACQUIRED PRIOR TO OR AFTER DELIVERY OF THE EVM.

7. *USER'S INDEMNITY OBLIGATIONS AND REPRESENTATIONS.* USER WILL DEFEND, INDEMNIFY AND HOLD TI, ITS LICENSORS AND THEIR REPRESENTATIVES HARMLESS FROM AND AGAINST ANY AND ALL CLAIMS, DAMAGES, LOSSES, EXPENSES, COSTS AND LIABILITIES (COLLECTIVELY, "CLAIMS") ARISING OUT OF OR IN CONNECTION WITH ANY HANDLING OR USE OF THE EVM THAT IS NOT IN ACCORDANCE WITH THESE TERMS AND CONDITIONS. THIS OBLIGATION SHALL APPLY WHETHER CLAIMS ARISE UNDER STATUTE, REGULATION, OR THE LAW OF TORT, CONTRACT OR ANY OTHER LEGAL THEORY, AND EVEN IF THE EVM FAILS TO PERFORM AS DESCRIBED OR EXPECTED.

8. *Limitations on Damages and Liability:*

8.1 *General Limitations.* IN NO EVENT SHALL TI BE LIABLE FOR ANY SPECIAL, COLLATERAL, INDIRECT, PUNITIVE, INCIDENTAL, CONSEQUENTIAL, OR EXEMPLARY DAMAGES IN CONNECTION WITH OR ARISING OUT OF THESE TERMS AND CONDITIONS OR THE USE OF THE EVMS PROVIDED HEREUNDER, REGARDLESS OF WHETHER TI HAS BEEN ADVISED OF THE POSSIBILITY OF SUCH DAMAGES. EXCLUDED DAMAGES INCLUDE, BUT ARE NOT LIMITED TO, COST OF REMOVAL OR REINSTALLATION, ANCILLARY COSTS TO THE PROCUREMENT OF SUBSTITUTE GOODS OR SERVICES, RETESTING, OUTSIDE COMPUTER TIME, LABOR COSTS, LOSS OF GOODWILL, LOSS OF PROFITS, LOSS OF SAVINGS, LOSS OF USE, LOSS OF DATA, OR BUSINESS INTERRUPTION. NO CLAIM, SUIT OR ACTION SHALL BE BROUGHT AGAINST TI MORE THAN ONE YEAR AFTER THE RELATED CAUSE OF ACTION HAS OCCURRED.

8.2 *Specific Limitations.* IN NO EVENT SHALL TI'S AGGREGATE LIABILITY FROM ANY WARRANTY OR OTHER OBLIGATION ARISING OUT OF OR IN CONNECTION WITH THESE TERMS AND CONDITIONS, OR ANY USE OF ANY TI EVM PROVIDED HEREUNDER, EXCEED THE TOTAL AMOUNT PAID TO TI FOR THE PARTICULAR UNITS SOLD UNDER THESE TERMS AND CONDITIONS WITH RESPECT TO WHICH LOSSES OR DAMAGES ARE CLAIMED. THE EXISTENCE OF MORE THAN ONE CLAIM AGAINST THE PARTICULAR UNITS SOLD TO USER UNDER THESE TERMS AND CONDITIONS SHALL NOT ENLARGE OR EXTEND THIS LIMIT.

9. *Return Policy.* Except as otherwise provided, TI does not offer any refunds, returns, or exchanges. Furthermore, no return of EVM(s) will be accepted if the package has been opened and no return of the EVM(s) will be accepted if they are damaged or otherwise not in a resalable condition. If User feels it has been incorrectly charged for the EVM(s) it ordered or that delivery violates the applicable order, User should contact TI. All refunds will be made in full within thirty (30) working days from the return of the components(s), excluding any postage or packaging costs.

10. *Governing Law:* These terms and conditions shall be governed by and interpreted in accordance with the laws of the State of Texas, without reference to conflict-of-laws principles. User agrees that non-exclusive jurisdiction for any dispute arising out of or relating to these terms and conditions lies within courts located in the State of Texas and consents to venue in Dallas County, Texas. Notwithstanding the foregoing, any judgment may be enforced in any United States or foreign court, and TI may seek injunctive relief in any United States or foreign court.

IMPORTANT NOTICE

Texas Instruments Incorporated and its subsidiaries (TI) reserve the right to make corrections, enhancements, improvements and other changes to its semiconductor products and services per JESD46, latest issue, and to discontinue any product or service per JESD48, latest issue. Buyers should obtain the latest relevant information before placing orders and should verify that such information is current and complete. All semiconductor products (also referred to herein as "components") are sold subject to TI's terms and conditions of sale supplied at the time of order acknowledgment.

TI warrants performance of its components to the specifications applicable at the time of sale, in accordance with the warranty in TI's terms and conditions of sale of semiconductor products. Testing and other quality control techniques are used to the extent TI deems necessary to support this warranty. Except where mandated by applicable law, testing of all parameters of each component is not necessarily performed.

TI assumes no liability for applications assistance or the design of Buyers' products. Buyers are responsible for their products and applications using TI components. To minimize the risks associated with Buyers' products and applications, Buyers should provide adequate design and operating safeguards.

TI does not warrant or represent that any license, either express or implied, is granted under any patent right, copyright, mask work right, or other intellectual property right relating to any combination, machine, or process in which TI components or services are used. Information published by TI regarding third-party products or services does not constitute a license to use such products or services or a warranty or endorsement thereof. Use of such information may require a license from a third party under the patents or other intellectual property of the third party, or a license from TI under the patents or other intellectual property of TI.

Reproduction of significant portions of TI information in TI data books or data sheets is permissible only if reproduction is without alteration and is accompanied by all associated warranties, conditions, limitations, and notices. TI is not responsible or liable for such altered documentation. Information of third parties may be subject to additional restrictions.

Resale of TI components or services with statements different from or beyond the parameters stated by TI for that component or service voids all express and any implied warranties for the associated TI component or service and is an unfair and deceptive business practice. TI is not responsible or liable for any such statements.

Buyer acknowledges and agrees that it is solely responsible for compliance with all legal, regulatory and safety-related requirements concerning its products, and any use of TI components in its applications, notwithstanding any applications-related information or support that may be provided by TI. Buyer represents and agrees that it has all the necessary expertise to create and implement safeguards which anticipate dangerous consequences of failures, monitor failures and their consequences, lessen the likelihood of failures that might cause harm and take appropriate remedial actions. Buyer will fully indemnify TI and its representatives against any damages arising out of the use of any TI components in safety-critical applications.

In some cases, TI components may be promoted specifically to facilitate safety-related applications. With such components, TI's goal is to help enable customers to design and create their own end-product solutions that meet applicable functional safety standards and requirements. Nonetheless, such components are subject to these terms.

No TI components are authorized for use in FDA Class III (or similar life-critical medical equipment) unless authorized officers of the parties have executed a special agreement specifically governing such use.

Only those TI components which TI has specifically designated as military grade or "enhanced plastic" are designed and intended for use in military/aerospace applications or environments. Buyer acknowledges and agrees that any military or aerospace use of TI components which have **not** been so designated is solely at the Buyer's risk, and that Buyer is solely responsible for compliance with all legal and regulatory requirements in connection with such use.

TI has specifically designated certain components as meeting ISO/TS16949 requirements, mainly for automotive use. In any case of use of non-designated products, TI will not be responsible for any failure to meet ISO/TS16949.

Products

Audio	www.ti.com/audio
Amplifiers	amplifier.ti.com
Data Converters	dataconverter.ti.com
DLP® Products	www.dlp.com
DSP	dsp.ti.com
Clocks and Timers	www.ti.com/clocks
Interface	interface.ti.com
Logic	logic.ti.com
Power Mgmt	power.ti.com
Microcontrollers	microcontroller.ti.com
RFID	www.ti-rfid.com
OMAP Applications Processors	www.ti.com/omap
Wireless Connectivity	www.ti.com/wirelessconnectivity

Applications

Automotive and Transportation	www.ti.com/automotive
Communications and Telecom	www.ti.com/communications
Computers and Peripherals	www.ti.com/computers
Consumer Electronics	www.ti.com/consumer-apps
Energy and Lighting	www.ti.com/energy
Industrial	www.ti.com/industrial
Medical	www.ti.com/medical
Security	www.ti.com/security
Space, Avionics and Defense	www.ti.com/space-avionics-defense
Video and Imaging	www.ti.com/video

TI E2E Community

e2e.ti.com