

THIS DOCUMENT IS SUBJECT TO CHANGE WITHOUT NOTICE. IT IS CONFIDENTIAL AND A PROPERTY OF AMPHENOL LTW. DISCLOSURE TO THIRD PARTY HAS TO BE AUTHORIZED BY AMPHENOL LTW.

REV.	ECN NO.	DATE	SIGN	DESCRIPTION

ALTW
 DCC. DEPT.
 CONFIDENTIAL
 2012-03-29
ISSUED

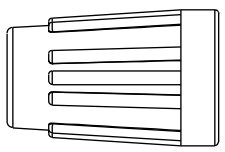

⑤ Sealing Nut

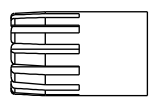

④ Clamp Ring

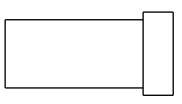

③ Seals B2

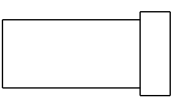

② Seals B1

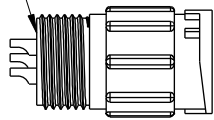

① Connector

With Liquid Glue
點 防水膠

ALTW
CONFIDENTIAL
 2012-03-21
R&D DEPT.

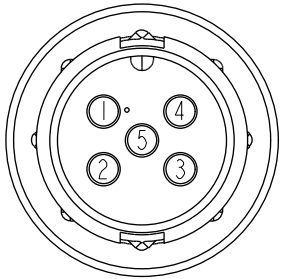
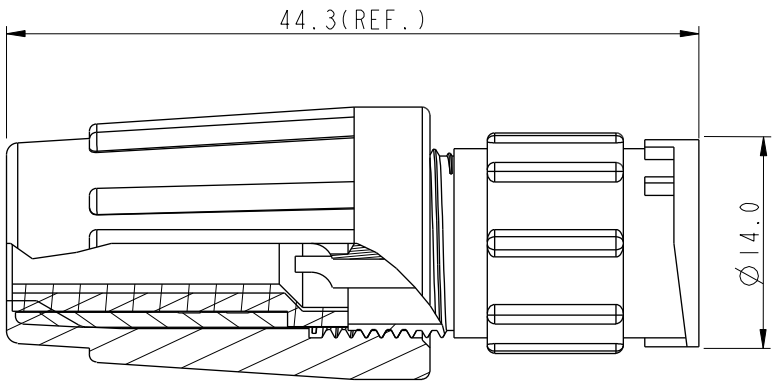

Pin Assignments
Front View 前視圖

Note:

- * Seals B1 for Cable OD: $\varnothing 4.5\text{mm} \sim \varnothing 6.5\text{mm}$
(防水墊圈B1線徑: $\varnothing 4.5\text{mm} \sim \varnothing 6.5\text{mm}$)
- * Seals B2 for Cable OD: $\varnothing 3.5\text{mm} \sim \varnothing 5.3\text{mm}$
(防水墊圈B2線徑: $\varnothing 3.5\text{mm} \sim \varnothing 5.3\text{mm}$)
- * One Set Unassembled in One PE Bag
(每一組未組裝, 放置於一個PE袋, 並封口)
- * CC Important Dimension.
- * Waterproof Rate : IP66
- * Housing: Black, Nylon+GF
- * Pin: Copper Alloy, Gold Plated
- * Seals: Black, EPDM
- * Clamping Ring: Black, Nylon
- * Sealing Nut: Black, Nylon
- * PE Bag: 90mm*85mm
- * Liquid Glue: Clear

UNIT: mm		TITLE Standard, Assy Lock 5Pin M Conn M Pin
TOLERANCE .X ±0.25 .XX ±0.1 .XXX ±0.05 ANGLES ±1°	SCALE 1:1	SIZE A4
	REV. A	SHEET 1 OF 1
	WC-REV. A.2	CC : Inspection item

Amphenol LTW
 安費諾亮泰企業股份有限公司

ITEM NO. BD-05BMMA-LL6001	DRAWN BY SamChang	DATE 2012-03-21
DWG NO. BD-05BMMA-LL6001	CHECKED BY Jeffrey	DATE 2012-03-29
CUSTOMER ALTW	APPROVED BY Kevin	DATE 2012-03-29