

IEC Appliance Outlet D, Screw-on Mounting, Front Side, Solder Terminal



See below:

Approvals and Compliances

Description

- Panel mount :
Screw-on mounting , Front Side
- Connector , Pin temperature 70 °C Protection class II
- Solder terminal

Weblinks

[pdf data sheet](#), [html datasheet](#), [General Product Information](#), [Approvals](#), [Distributor-Stock-Check](#), [Accessories](#), [Detailed request for product](#)

Technical Data

Ratings IEC	2.5 A / 250 VAC; 50 Hz	Appliance inlet/-outlet	D acc. to IEC 60320-3
Ratings UL/CSA	2.5 A / 250 VAC; 60 Hz		UL 60320-1, CSA C22.2 no. 60320-1
	7 A / 125 VAC; 60 Hz		(for cold conditions) pin-temperature 70 °C, 2.5 A, Protection Class II
Dielectric Strength	> 4 kVAC between L-N > 2 kVAC between L/N-PE (1 min/50 Hz)		
Allowable Operation Temperature	-25 °C to 70 °C		
IP-Protection	front side IP20 acc. to IEC 60529		
Protection against electric shock	Suitable for appliances with protection class II acc. to IEC 61140		
Material: Housing	PA6, black, UL 94V-0		

Approvals and Compliances

Detailed information on product approvals, code requirements, usage instructions and detailed test conditions can be looked up in [Details about Approvals](#)

SCHURTER products are designed for use in industrial environments. They have approvals from independent testing bodies according to national and international standards. Products with specific characteristics and requirements such as required in the automotive sector according to IATF 16949, medical technology according to ISO 13485 or in the aerospace industry can be offered exclusively with customer-specific, individual agreements by SCHURTER.

Approvals





The approval mark is used by the testing authorities to certify compliance with the safety requirements placed on electronic products.

Approval Reference Type: 5088

Approval Logo	Certificates	Certification Body	Description
	VDE Approvals	VDE	VDE Certificate Number: 40034348
	UL Approvals	UL	UL File Number: E103791

Product standards

Product standards that are referenced

Organization	Design	Standard	Description
	Designed according to	IEC 60320-1	Appliance couplers for household and similar general purposes
	Designed according to	IEC 60320-3	Appliance couplers for household and similar general purposes
	Designed according to	UL 60320-1	Standard for Attachment Plugs and Receptacles
	Designed according to	CSA C22.2 no. 60320-1	General Use Receptacles, Attachment Plugs, and Similar Wiring Devices





Application standards

Application standards where the product can be used

Organization	Design	Standard	Description
	Designed for applications acc.	IEC/UL 62368-1	Audio/video, information and communication technology equipment - Part 1: Safety requirements

Compliances

The product complies with following Guide Lines

Identification	Details	Initiator	Description
	CE declaration of conformity	SCHURTER AG	The CE marking declares that the product complies with the applicable requirements laid down in the harmonisation of Community legislation on its affixing in accordance with EU Regulation 765/2008.
	UKCA declaration of conformity	SCHURTER AG	The UKCA marking declares that the product complies with the applicable requirements laid down in the British Amendment of Regulation (EC) 765/2008.
	RoHS	SCHURTER AG	Directive RoHS 2011/65/EU, Amendment (EU) 2015/863
	China RoHS	SCHURTER AG	The law SJ / T 11363-2006 (China RoHS) has been in force since 1 March 2007. It is similar to the EU directive RoHS.
	REACH	SCHURTER AG	On 1 June 2007, Regulation (EC) No 1907/2006 on the Registration, Evaluation, Authorization and Restriction of Chemicals 1 (abbreviated as "REACH") entered into force.

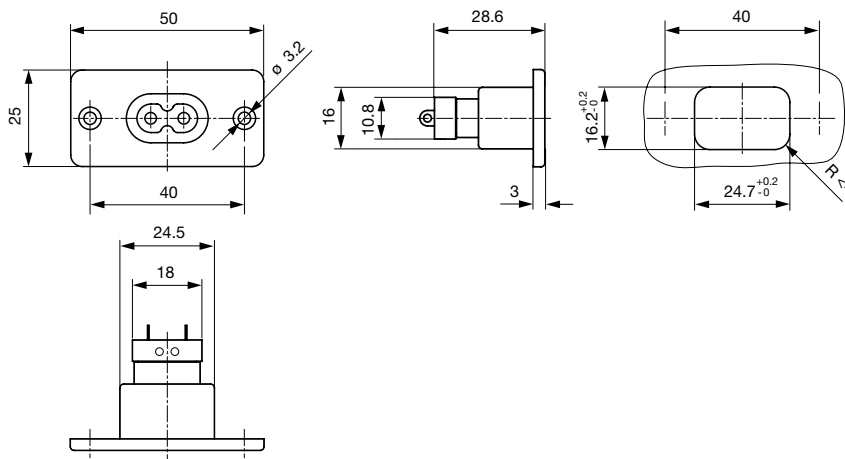
Dimensions [mm]

Length of the terminal please find at the order code configuration table

Config. Code

5088 - H - A B C 0 - D - E

The characters are placeholders for the correspondingly keys of selections from the key tables.

5088 - **H** - A B C 0 - D - E = Type

Type

Configuration key

protection class II

X

5088 - H - **A** B C 0 - D - E = Terminals

Terminal L

Configuration key

solder terminal



1

5088 - H - A **B** C 0 - D - E = Terminals

Terminal N

Configuration key

solder terminal

1

Symbols similar as in table A

5088 - H - A B **C** 0 - D - E = Terminals

Terminal Ground

Configuration key

without terminal

0

Symbols similar as in table A

5088 - H - A B C 0 - **D** - E = Color

Color

Configuration key

Black

A

5088 - H - A B C 0 - D - **E** = Style

Style

Configuration key

flange with countersunk holes

1

flange with through holes

2

All Variants

Terminals L / N	Color	Style	Config. Code	Order Number
solder terminal	black	Flange with countersunk holes	5088-X-1100-A-1	6180.0007

The listed variants should be available from stock. Other versions on request www.schurter.com/contact

Availability for all products can be searched real-time: <https://www.schurter.com/en/Stock-Check/Stock-Check-SCHURTER>

Packaging unit

50 Pcs