

**BU-23842-000**  
SHT 1.1

NOTE:  
 LOCATED FROM TWO SURFACES FOR CUSTOMER CONVENIENCE. ONLY APPLICABLE FROM ONE SURFACE, NOT TO BE USED TOGETHER. HORIZONTAL LOCATION FOR TERMINAL CENTERED TO  $\pm 0,17$  [  $\pm 0,007$  ].

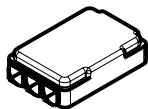
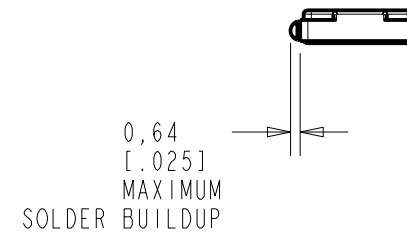
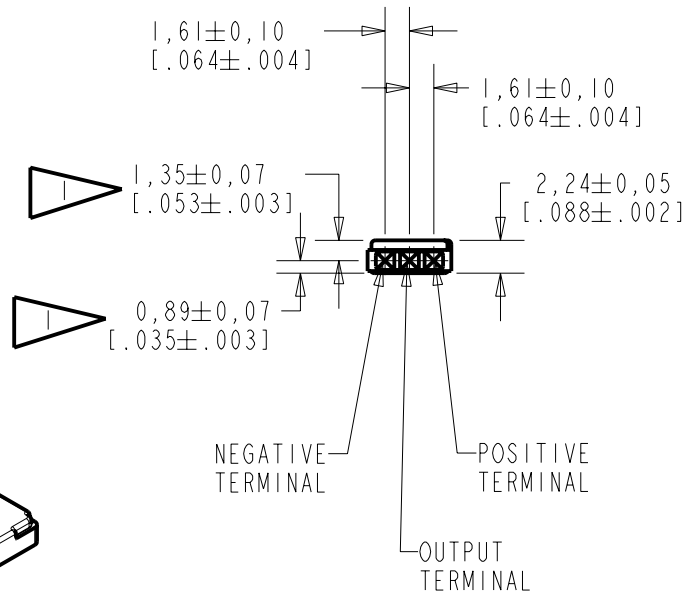
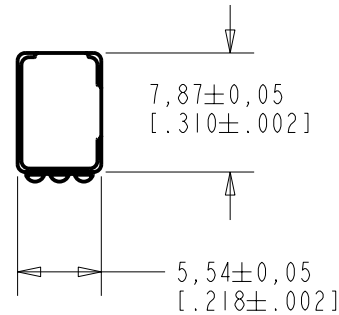

DIMENSIONS IN MILLIMETERS [INCHES]

**KNOWLES ELECTRONICS**  
ITASCA, ILLINOIS U.S.A.

Revision	C.O. #	Implementation Date	RELEASE LEVEL	REVISION
C	MI0101515	7-16-07	Released	C
B	MI0101175	9-20-06		
SCALE: 2:1			DR. BY	DATE
DO NOT SCALE DRAWING			AB	9-20-06
TITLE: VIBRATION TRANSDUCER			CK. BY	DATE
OUTLINE DRAWING			GJP	9-25-06
BU-23842-000			APP. BY	DATE
SHT 1.1			GJP	9-25-06

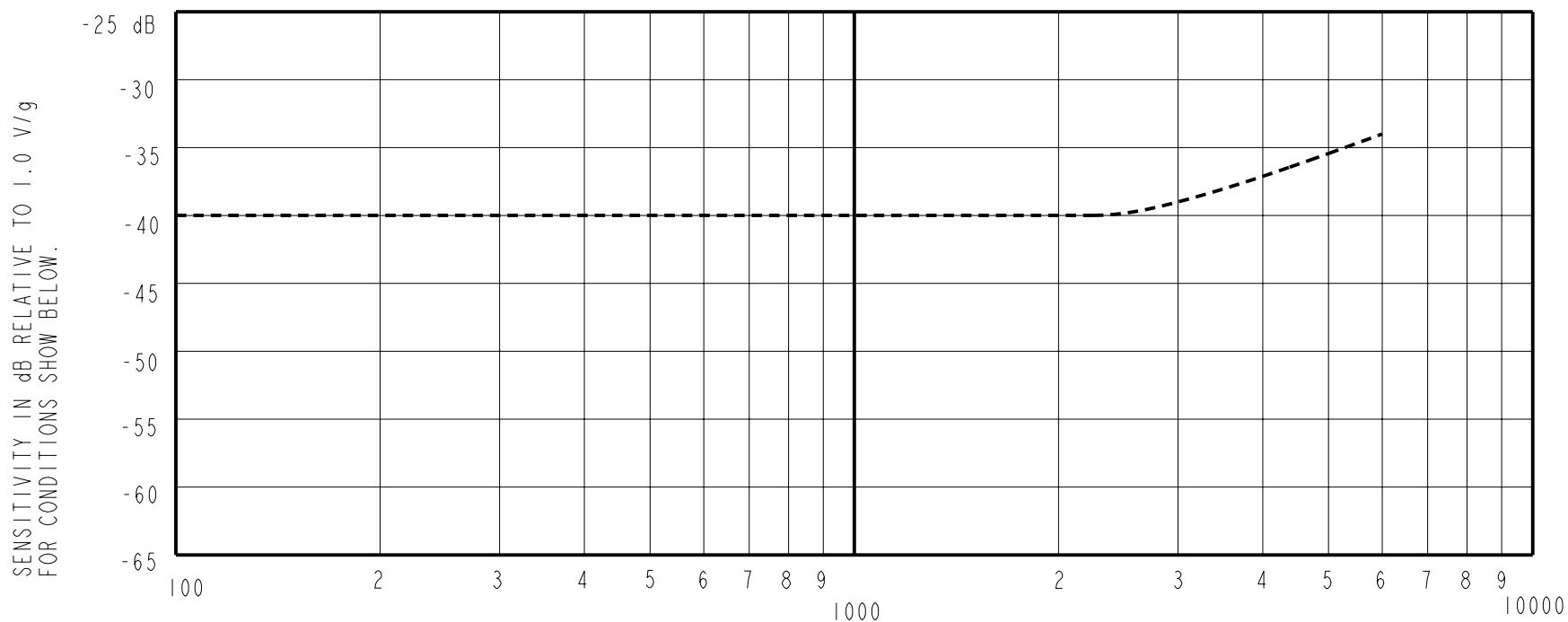

FREQUENCY	SENSITIVITY			DEVICE CONFORMITY	
	MIN.	NOM.	MAX.	RANGE OF DEVIATION FROM 1 kHz	
300	---	-40.0	---	-2.0	0
1000	-44.0	-40.0	-36.0	0	0
3000	---	-38.0	---	0	+6.0

NOTES:

1. ALL DATA MEASURED WITH CIRCUIT CONFIGURATION SHOWN BELOW.
2. CASE CONNECTED TO NEGATIVE TERMINAL.

DC SUPPLY	BATTERY CURRENT DRAIN	"A" WEIGHTED NOISE (RE 1.0V)	OUTPUT IMPEDANCE OHMS (AT 1 kHz)		
			MIN.	NOM.	MAX.
1.5 V	50 $\mu$ A MAX.	-103 dB MAX.	4900	5200	5500

3. TEST CONDITIONS:

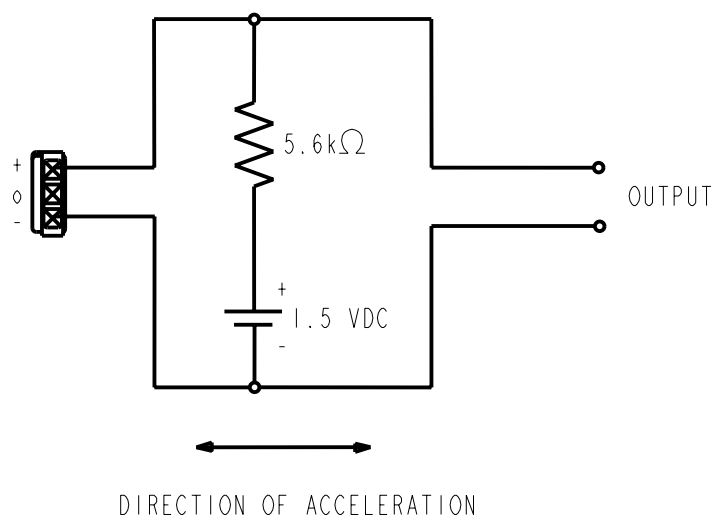

Revision	C.O. #	Implementation Date	RELEASE LEVEL	REVISION
C	MI0101515	7-16-07	Released	C
B	MI0101175	9-20-06		

**KNOWLES ELECTRONICS**  
ITASCA, ILLINOIS U.S.A.

WHEN TEST LIMITS ARE USED TO ESTABLISH INCOMING INSPECTION ACCEPTANCE/REJECTION CRITERIA, CORRELATION OF TEST EQUIPMENT WITH KNOWLES IS ALSO REQUIRED FOR ELIMINATION OF EQUIPMENT AND TEST METHOD VARIATION

TITLE: **VIBRATION TRANSDUCER** **BU-23842-000**  
PERFORMANCE SPECIFICATION **SHT 2.1**

DR. BY	DATE
AB	9-20-06
CK. BY	DATE
GJP	9-25-06
APP. BY	DATE
GJP	9-25-06