

## SUMMARY



Image is for illustrative purpose only

### # Wires

Low voltage 2

Series 1S  
Termination type Male solder  
IP rating 50  
AWG wire size 28.00 - 20.00  
Cable Ø 4.20 - 5.20 mm  
Status active  
Matching parts [ERA.1S.302.CLL](#)

### Download

[Request a quote](#)  
[Eplan](#)  
[Catalog](#)

## TECHNICAL DETAILS

### Mechanics

Shell Style/Model FFA\*: Straight plug, cable collet  
Keying Hermaphroditic keying (half moon insert) with male pin 1  
Housing Material Brass (chrome plated [SAE AMS 2460]) shell and collet nut, nickel plated [SAE AMS QQ N 290] brass latch sleeve and mid pieces  
Weight 17.25 g

### Performance

Configuration 1S.302 : 2 Low Voltage  
Insulator L: PEEK (UL 94 / V-0/1.5)  
Rated Current 15 Amps

### Specifications

Contact Type: Solder  
Contact Dia.: 1.3 mm (0.051in)  
Bucket Dia.: 1 mm (0.039in)  
Max. Solid Conductor: 0.5 mm<sup>2</sup> (AWG 20)  
Max. Stranded Conductor: 0.5 mm<sup>2</sup> (AWG 20)  
R (max): 3.6 mOhm  
Vtest: 1200 V (AC), 1800 V (DC)

LEMO products and services are provided "as is". LEMO makes no warranties or representations with regard to LEMO product & services or use of them, express, implied or statutory, including for accuracy, completeness, or security. The user is fully responsible for his products and applications using LEMO components.

## Others

Endurance (Shell): 5000 mating cycles  
Temp (min / max): -55°C / +250°C  
Humidity (max): <=95% [at 60 deg C / 140 F]  
Vibration: 15 g [10 Hz - 2000 Hz]  
Shock Resistance: 100 g [ 6 ms]  
Climatical Category: 50/175/21  
Shielding (min): 75 dB (10 MHz)  
Shielding (min): 40 dB (1 GHz)  
Salt Spray Corrosion: >144 hr

## DRAWINGS

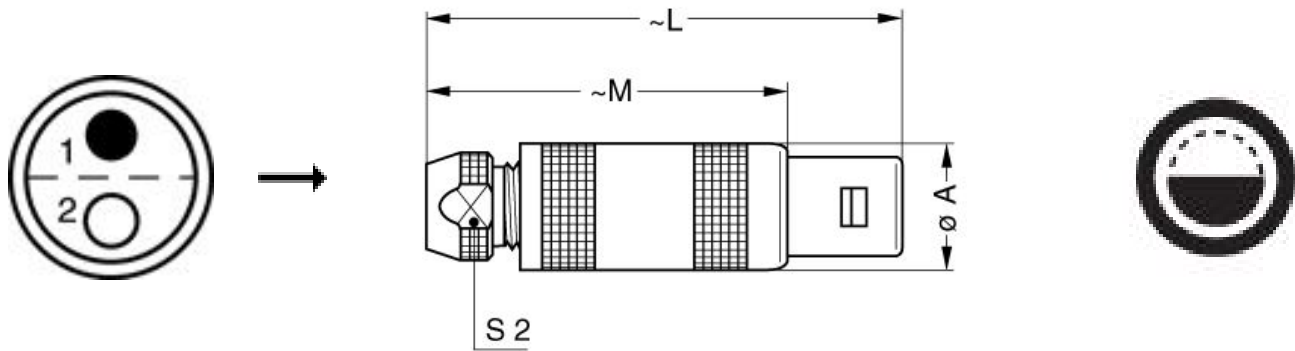

## Dimensions

	A	L	M	S2
mm.	12	42.5	31.5	8.5
in.	0,47	1,67	1,24	0,33









## RECOMMENDED BY LEMO

### Tools

Spanner wrench: [DCD.1S.015.PA085](#)

*LEMO products and services are provided "as is". LEMO makes no warranties or representations with regard to LEMO product & services or use of them, express, implied or statutory, including for accuracy, completeness, or security. The user is fully responsible for his products and applications using LEMO components.*

## Cables

CMN.02.T20.047PGZE		Grey	
CMN.02.T20.047PNZE			
CMN.02.T20.048QGZE	TPR (medical)	Grey	
120240	PVC	Black	
120250	PVC	Grey	
120501	PVC	Grey	
20260	PVC	Black	
2221	PVC	Black	
4082	PVC	Grey	

LEMO products and services are provided "as is". LEMO makes no warranties or representations with regard to LEMO product & services or use of them, express, implied or statutory, including for accuracy, completeness, or security. The user is fully responsible for his products and applications using LEMO components.