

# NTTFS4H05N

## MOSFET – Power, Single, N-Channel, $\mu$ 8-FL 25 V, 94 A

### Features

- Optimized Design to Minimize Conduction and Switching Losses
- Optimized Package to Minimize Parasitic Inductances
- Optimized material for improved thermal performance
- These Devices are Pb-Free, Halogen Free/BFR Free and are RoHS Compliant

### Applications

- High Performance DC-DC Converters
- System Voltage Rails
- Netcom, Telecom
- Servers & Point of Load

### MAXIMUM RATINGS ( $T_J = 25^\circ\text{C}$ unless otherwise stated)

Parameter	Symbol	Value	Units
Drain-to-Source Voltage	$V_{DSS}$	25	V
Gate-to-Source Voltage	$V_{GS}$	$\pm 20$	V
Continuous Drain Current $R_{\theta JA}$ ( $T_A = 25^\circ\text{C}$ , Note 1)	$I_D$	22.4	A
Power Dissipation $R_{\theta JA}$ ( $T_A = 25^\circ\text{C}$ , Note 1)	$P_D$	2.66	W
Continuous Drain Current $R_{\theta JC}$ ( $T_C = 25^\circ\text{C}$ , Note 1)	$I_D$	94	A
Power Dissipation $R_{\theta JC}$ ( $T_C = 25^\circ\text{C}$ , Note 1)	$P_D$	46.3	W
Pulsed Drain Current ( $t_p = 10 \mu\text{s}$ )	$I_{DM}$	304	A
Single Pulse Drain-to-Source Avalanche Energy (Note 1) ( $I_L = 41 \text{ A}_{pk}$ , $L = 0.1 \text{ mH}$ ) (Note 3)	$E_{AS}$	84	mJ
Drain to Source $dV/dt$	$dV/dt$	7	V/ns
Maximum Junction Temperature	$T_{J(max)}$	150	$^\circ\text{C}$
Storage Temperature Range	$T_{STG}$	-55 to 150	$^\circ\text{C}$
Lead Temperature Soldering Reflow (SMD Styles Only), Pb-Free Versions (Note 2)	$T_{SLD}$	260	$^\circ\text{C}$

Stresses exceeding those listed in the Maximum Ratings table may damage the device. If any of these limits are exceeded, device functionality should not be assumed, damage may occur and reliability may be affected.

1. Values based on copper area of  $645 \text{ mm}^2$  (or  $1 \text{ in}^2$ ) of 2 oz copper thickness and FR4 PCB substrate.
2. For more information, please refer to our Soldering and Mounting Techniques Reference Manual, SOLDERRM/D.
3. This is the absolute maximum rating. Parts are 100% UIS tested at  $T_J = 25^\circ\text{C}$ ,  $V_{GS} = 10 \text{ V}$ ,  $I_L = 27 \text{ A}$ ,  $E_{AS} = 36 \text{ mJ}$ .



ON Semiconductor®

[www.onsemi.com](http://www.onsemi.com)

$V_{GS}$	MAX $R_{DS(on)}$	TYP $Q_{GTOT}$
4.5 V	4.8 $\text{m}\Omega$	8.7 nC
10 V	3.3 $\text{m}\Omega$	18.9 nC



WDFN8  
( $\mu$ 8FL)  
CASE 511AB

### MARKING DIAGRAM

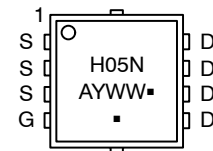

H05N = Specific Device Code  
A = Assembly Location  
Y = Year  
WW = Work Week  
▪ = Pb-Free Package

(Note: Microdot may be in either location)

### PIN CONNECTIONS

$\mu$ 8-FL (3.3 x 3.3 mm)

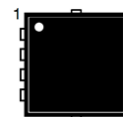

(Top View)

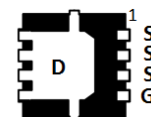

(Bottom View)

### N-CHANNEL MOSFET

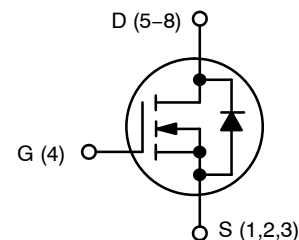

### ORDERING INFORMATION

See detailed ordering and shipping information on page 7 of this data sheet.

# NTTFS4H05N

## THERMAL CHARACTERISTICS

Parameter	Symbol	Max	Units
Thermal Resistance, Junction-to-Ambient (Note 1 and 4)	$R_{\theta JA}$	47	$^{\circ}\text{C}/\text{W}$
Junction-to-Case (Note 1 and 4)	$R_{\theta JC}$	2.7	

4. Thermal Resistance  $R_{\theta JA}$  and  $R_{\theta JC}$  as defined in JESD51-3.

# NTTFS4H05N

## ELECTRICAL CHARACTERISTICS ( $T_J = 25^\circ\text{C}$ unless otherwise specified)

Parameter	Symbol	Test Condition	Min	Typ	Max	Unit
<b>OFF CHARACTERISTICS</b>						
Drain-to-Source Breakdown Voltage	$V_{(BR)DSS}$	$V_{GS} = 0\text{ V}, I_D = 250\ \mu\text{A}$	25			V
Drain-to-Source Breakdown Voltage Temperature Coefficient	$V_{(BR)DSS}/T_J$			15		mV/°C
Zero Gate Voltage Drain Current	$I_{DSS}$	$V_{GS} = 0\text{ V}, V_{DS} = 20\text{ V}$	$T_J = 25^\circ\text{C}$		1.0	$\mu\text{A}$
			$T_J = 125^\circ\text{C}$		20	
Gate-to-Source Leakage Current	$I_{GSS}$	$V_{DS} = 0\text{ V}, V_{GS} = 20\text{ V}$			100	nA

## ON CHARACTERISTICS (Note 5)

Gate Threshold Voltage	$V_{GS(TH)}$	$V_{GS} = V_{DS}, I_D = 250\ \mu\text{A}$	1.2		2.1	V
Negative Threshold Temperature Coefficient	$V_{GS(TH)}/T_J$			3.8		mV/°C
Drain-to-Source On Resistance	$R_{DS(on)}$	$V_{GS} = 10\text{ V}, I_D = 30\text{ A}$		2.5	3.3	m $\Omega$
		$V_{GS} = 4.5\text{ V}, I_D = 30\text{ A}$		3.8	4.8	
Forward Transconductance	$g_{FS}$	$V_{DS} = 12\text{ V}, I_D = 15\text{ A}$		69		S

## CHARGES AND CAPACITANCES

Input Capacitance	$C_{ISS}$	$V_{GS} = 0\text{ V}, f = 1\text{ MHz}, V_{DS} = 12\text{ V}$		1205	1812	pF
Output Capacitance	$C_{OSS}$			835	1293	
Reverse Transfer Capacitance	$C_{RSS}$			45	81	
Total Gate Charge	$Q_{G(TOT)}$	$V_{GS} = 4.5\text{ V}, V_{DS} = 12\text{ V}; I_D = 30\text{ A}$		8.7	18.6	nC
Threshold Gate Charge	$Q_{G(TH)}$			2.7	6.0	
Gate-to-Source Charge	$Q_{GS}$			3.6	6.2	
Gate-to-Drain Charge	$Q_{GD}$			1.88	5.6	
Total Gate Charge	$Q_{G(TOT)}$	$V_{GS} = 10\text{ V}, V_{DS} = 12\text{ V}; I_D = 30\text{ A}$		18.9	40	nC
Gate Resistance	$R_G$	$T_A = 25^\circ\text{C}$		1.0	2.0	$\Omega$

## SWITCHING CHARACTERISTICS (Note 6)

Turn-On Delay Time	$t_{d(ON)}$	$V_{GS} = 4.5\text{ V}, V_{DS} = 12\text{ V}, I_D = 15\text{ A}, R_G = 3.0\ \Omega$		8.9		ns
Rise Time	$t_r$			32		
Turn-Off Delay Time	$t_{d(OFF)}$			14.6		
Fall Time	$t_f$			3		

## SWITCHING CHARACTERISTICS (Note 6)

Turn-On Delay Time	$t_{d(ON)}$	$V_{GS} = 10\text{ V}, V_{DS} = 12\text{ V}, I_D = 15\text{ A}, R_G = 3.0\ \Omega$		6.0		ns
Rise Time	$t_r$			27		
Turn-Off Delay Time	$t_{d(OFF)}$			18.6		
Fall Time	$t_f$			2.3		

## DRAIN-SOURCE DIODE CHARACTERISTICS

Forward Diode Voltage	$V_{SD}$	$V_{GS} = 0\text{ V}, I_S = 10\text{ A}$	$T_J = 25^\circ\text{C}$		0.78	1.1	V
			$T_J = 125^\circ\text{C}$		0.6		
Reverse Recovery Time	$t_{RR}$	$V_{GS} = 0\text{ V}, dI_S/dt = 100\text{ A}/\mu\text{s}, I_S = 10\text{ A}$		30.8	66	ns	
Charge Time	$t_a$			15			
Discharge Time	$t_b$			15.8			
Reverse Recovery Charge	$Q_{RR}$			20			nC

Product parametric performance is indicated in the Electrical Characteristics for the listed test conditions, unless otherwise noted. Product performance may not be indicated by the Electrical Characteristics if operated under different conditions.

5. Pulse Test: pulse width  $\leq 300\ \mu\text{s}$ , duty cycle  $\leq 2\%$ .

6. Switching characteristics are independent of operating junction temperatures.

# NTTFS4H05N

## TYPICAL CHARACTERISTICS

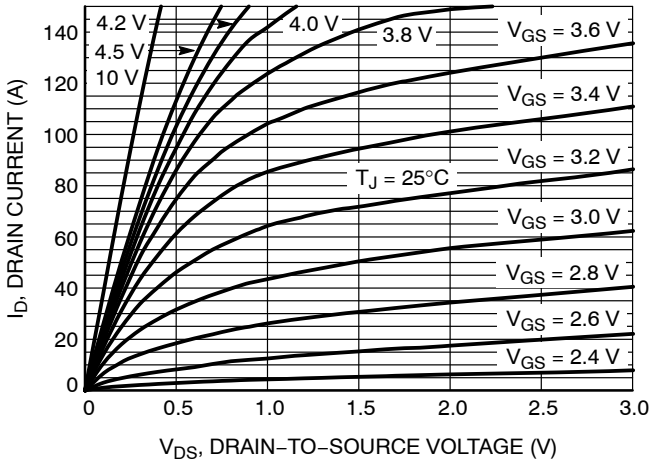

Figure 1. On-Region Characteristics

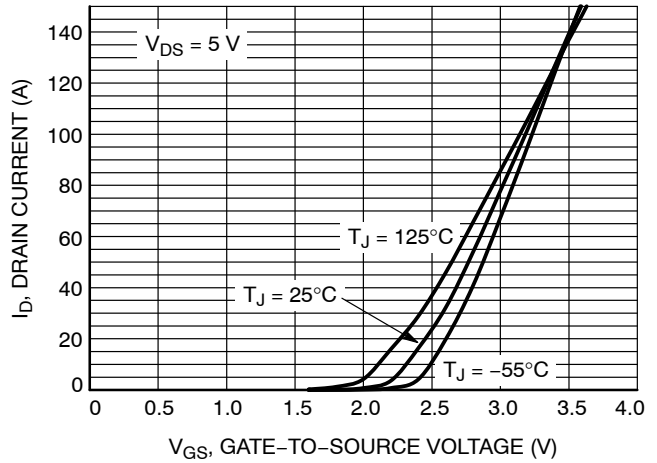

Figure 2. Transfer Characteristics

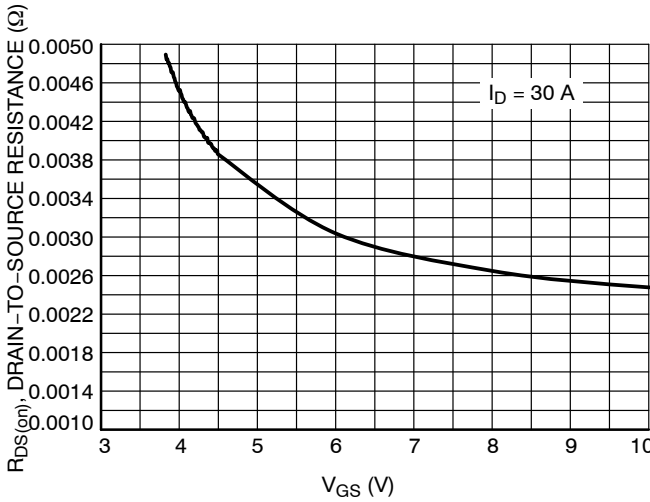

Figure 3. On-Resistance vs.  $V_{GS}$

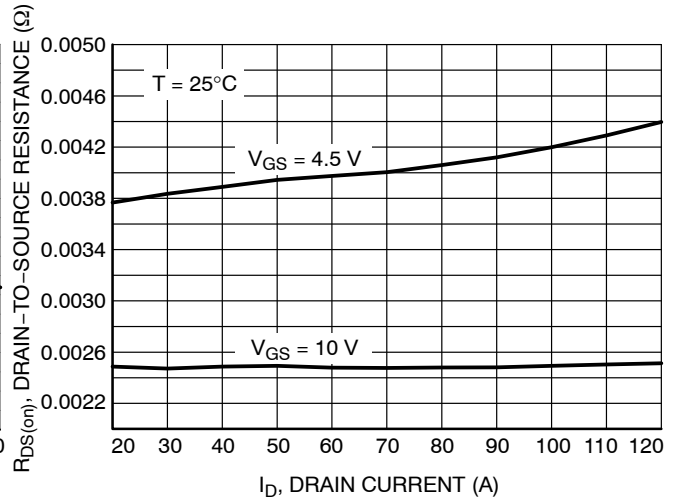

Figure 4. On-Resistance vs. Drain Current and Gate Voltage

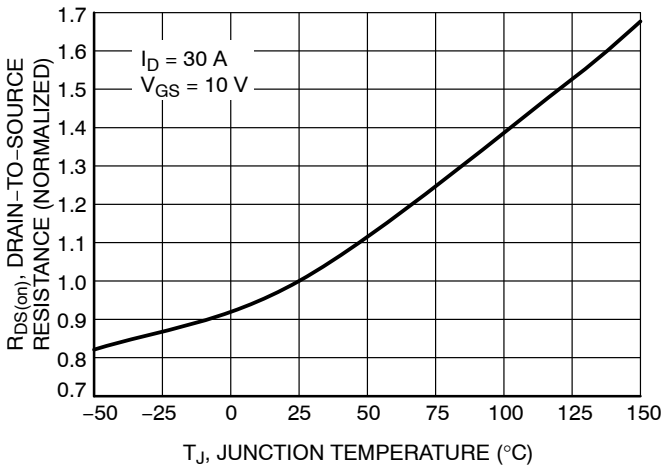

Figure 5. On-Resistance Variation with Temperature

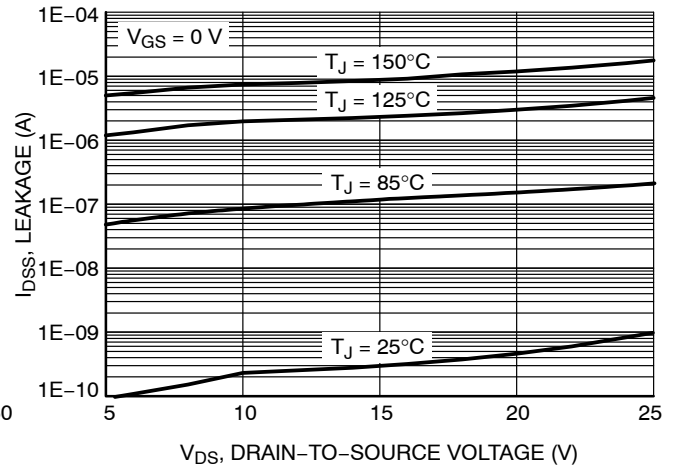
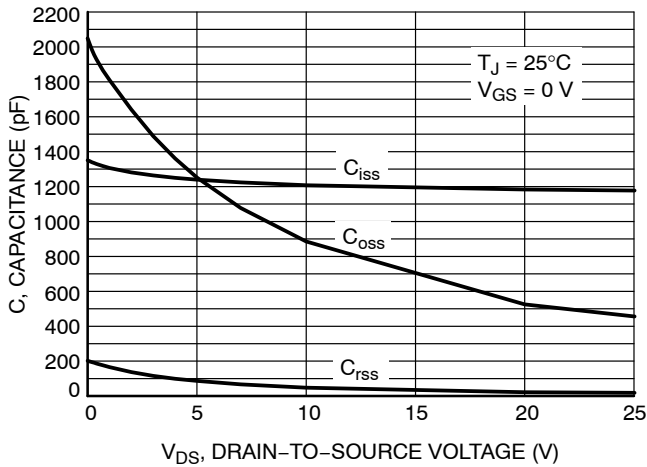

Figure 6. Drain-to-Source Leakage Current vs. Voltage

# NTTFS4H05N

## TYPICAL CHARACTERISTICS



**Figure 7. Capacitance Variation**

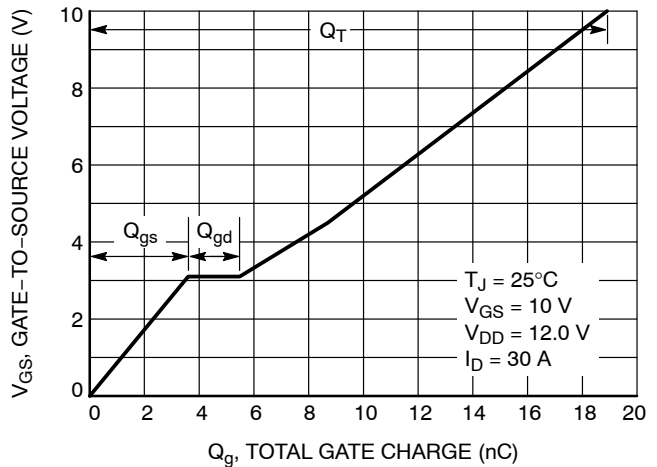

**Figure 8. Gate-to-Source and Drain-to-Source Voltage vs. Total Charge**

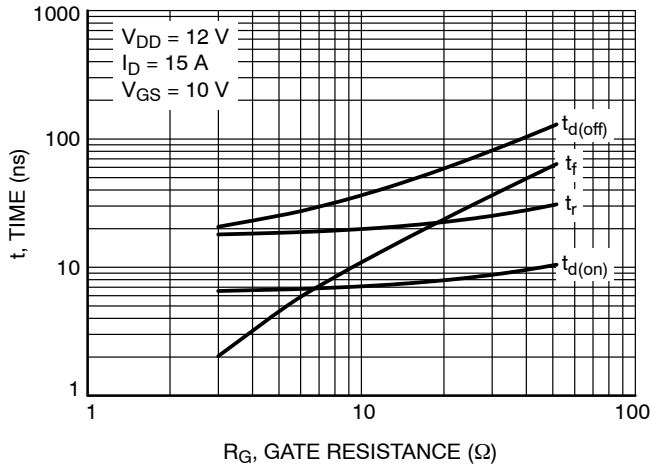

**Figure 9. Resistive Switching Time Variation vs. Gate Resistance**

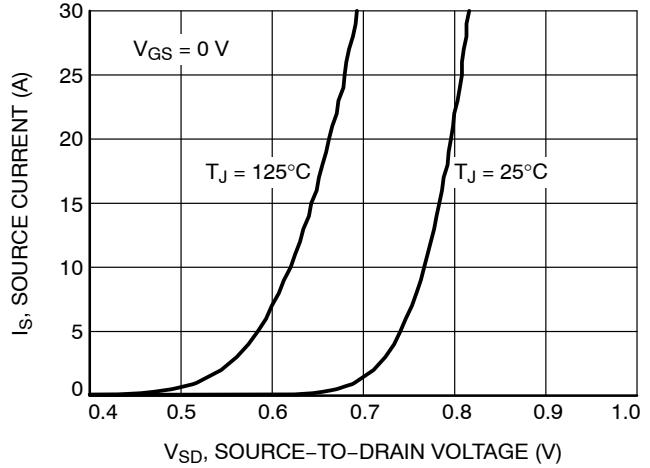

**Figure 10. Diode Forward Voltage vs. Current**

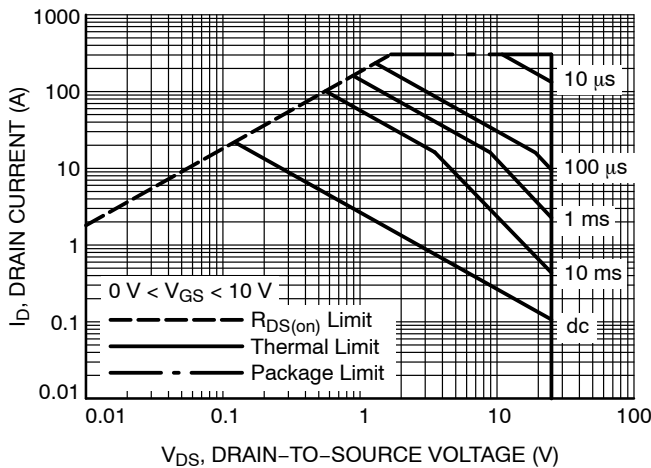

**Figure 11. Maximum Rated Forward Biased Safe Operating Area**

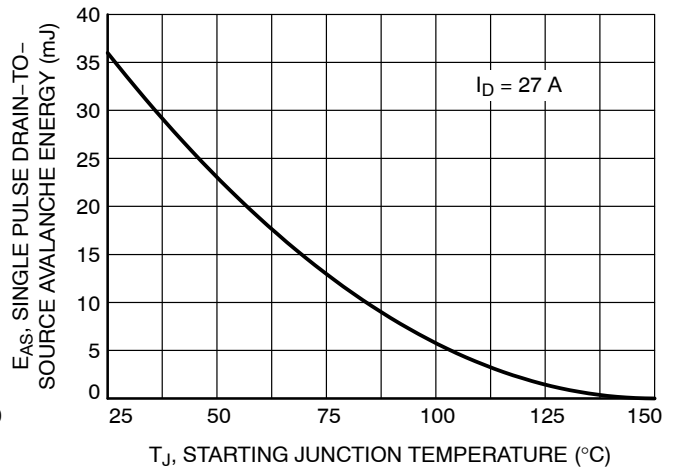

**Figure 12. Maximum Avalanche Energy vs. Starting Junction Temperature**

# NTTFS4H05N

## TYPICAL CHARACTERISTICS

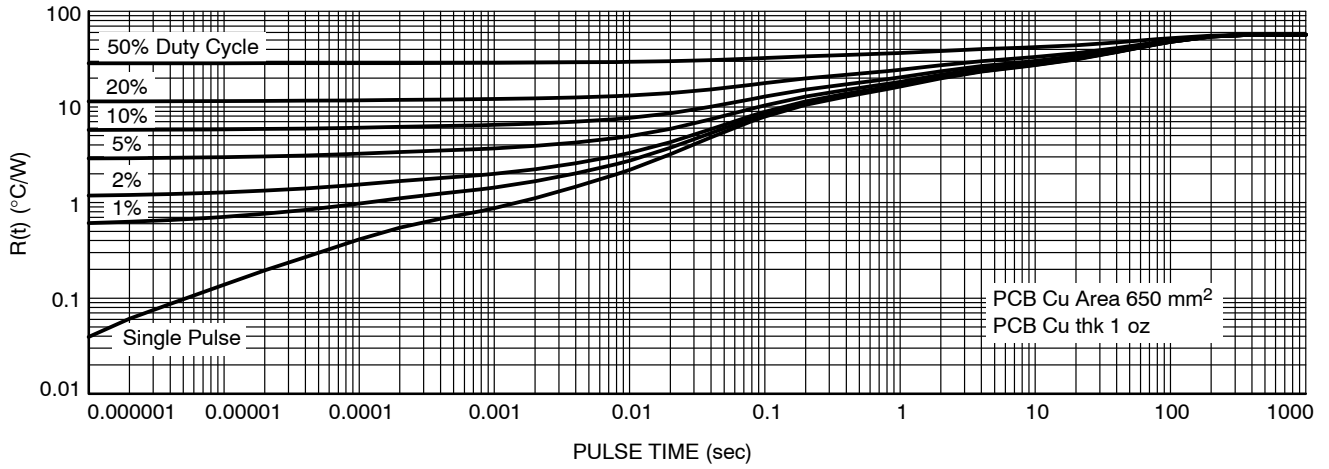

Figure 13. Thermal Characteristics

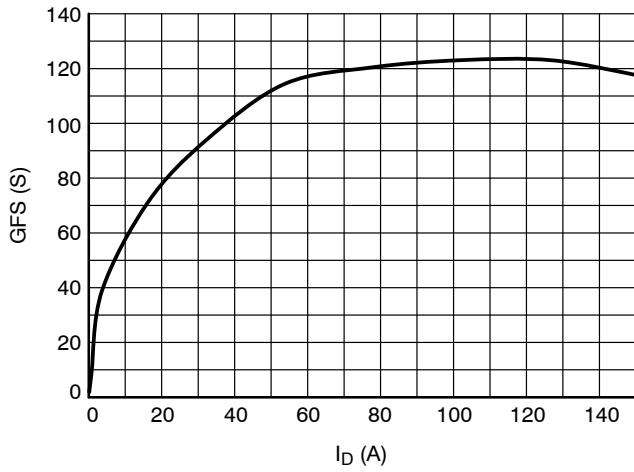

Figure 14. GFS vs.  $I_D$

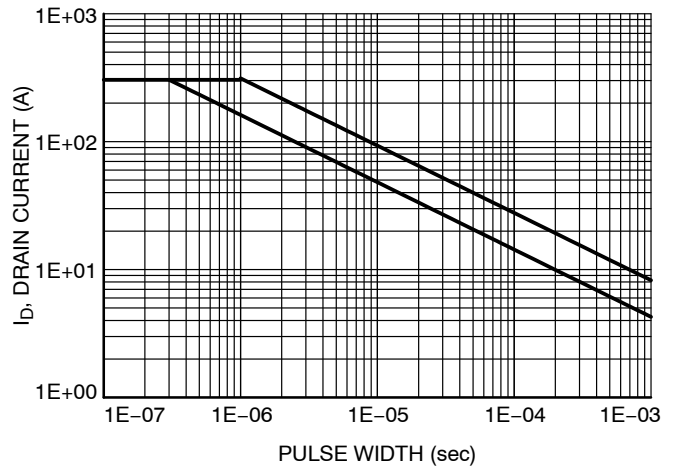

Figure 15. Avalanche Characteristics

# NTTFS4H05N

## ORDERING INFORMATION

Device	Package	Shipping†
NTTFS4H05NTAG	WDFN8 (Pb-Free)	1500 / Tape & Reel
NTTFS4H05NTWG	WDFN8 (Pb-Free)	5000 / Tape & Reel

†For information on tape and reel specifications, including part orientation and tape sizes, please refer to our Tape and Reel Packaging Specifications Brochure, BRD8011/D.

# MECHANICAL CASE OUTLINE

## PACKAGE DIMENSIONS

ON Semiconductor®



SCALE 2:1

### WDFN8 3.3x3.3, 0.65P CASE 511AB ISSUE D

DATE 23 APR 2012

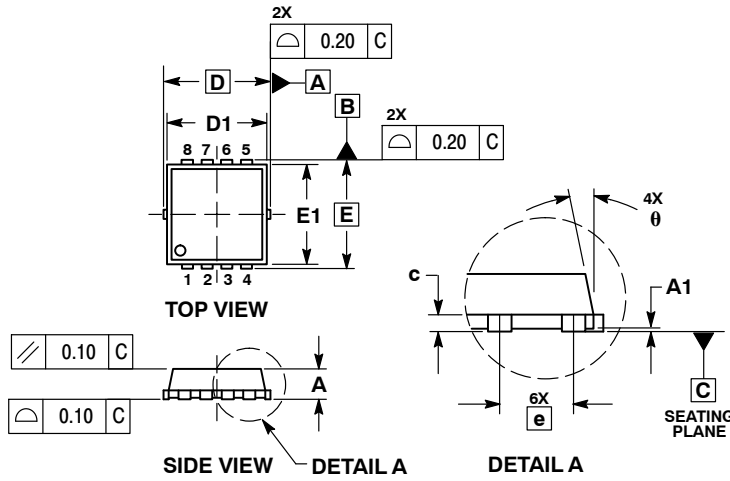

NOTES:

1. DIMENSIONING AND TOLERANCING PER ASME Y14.5M, 1994.
2. CONTROLLING DIMENSION: MILLIMETERS.
3. DIMENSION D1 AND E1 DO NOT INCLUDE MOLD FLASH PROTRUSIONS OR GATE BURRS.

DIM	MILLIMETERS			INCHES		
	MIN	NOM	MAX	MIN	NOM	MAX
A	0.70	0.75	0.80	0.028	0.030	0.031
A1	0.00	---	0.05	0.000	---	0.002
b	0.23	0.30	0.40	0.009	0.012	0.016
c	0.15	0.20	0.25	0.006	0.008	0.010
D	3.30 BSC			0.130 BSC		
D1	2.95	3.05	3.15	0.116	0.120	0.124
D2	1.98	2.11	2.24	0.078	0.083	0.088
E	3.30 BSC			0.130 BSC		
E1	2.95	3.05	3.15	0.116	0.120	0.124
E2	1.47	1.60	1.73	0.058	0.063	0.068
E3	0.23	0.30	0.40	0.009	0.012	0.016
e	0.65 BSC			0.026 BSC		
G	0.30	0.41	0.51	0.012	0.016	0.020
K	0.65	0.80	0.95	0.026	0.032	0.037
L	0.30	0.43	0.56	0.012	0.017	0.022
L1	0.06	0.13	0.20	0.002	0.005	0.008
M	1.40	1.50	1.60	0.055	0.059	0.063
θ	0°	---	12°	0°	---	12°

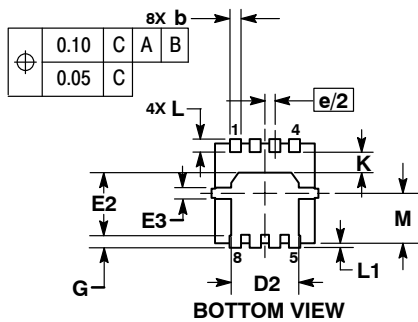

GENERIC MARKING DIAGRAM\*

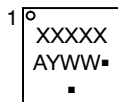

- XXXXX = Specific Device Code
- A = Assembly Location
- Y = Year
- WW = Work Week
- = Pb-Free Package

\*This information is generic. Please refer to device data sheet for actual part marking.  
Pb-Free indicator, "G" or microdot "▪", may or may not be present.

SOLDERING FOOTPRINT\*

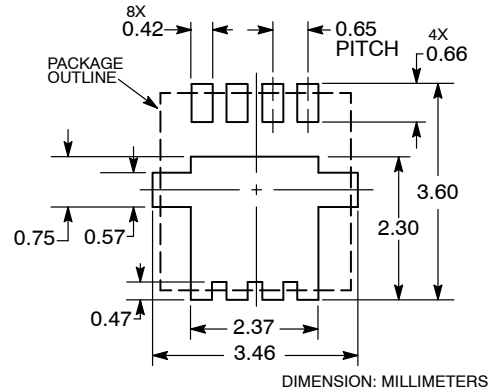

DIMENSION: MILLIMETERS

\*For additional information on our Pb-Free strategy and soldering details, please download the ON Semiconductor Soldering and Mounting Techniques Reference Manual, SOLDERRM/D.

DOCUMENT NUMBER:	98AON30561E	Electronic versions are uncontrolled except when accessed directly from the Document Repository. Printed versions are uncontrolled except when stamped "CONTROLLED COPY" in red.
DESCRIPTION:	WDFN8 3.3X3.3, 0.65P	PAGE 1 OF 1

ON Semiconductor and ON are trademarks of Semiconductor Components Industries, LLC dba ON Semiconductor or its subsidiaries in the United States and/or other countries. ON Semiconductor reserves the right to make changes without further notice to any products herein. ON Semiconductor makes no warranty, representation or guarantee regarding the suitability of its products for any particular purpose, nor does ON Semiconductor assume any liability arising out of the application or use of any product or circuit, and specifically disclaims any and all liability, including without limitation special, consequential or incidental damages. ON Semiconductor does not convey any license under its patent rights nor the rights of others.



**onsemi**, **Onsemi**, and other names, marks, and brands are registered and/or common law trademarks of Semiconductor Components Industries, LLC dba "**onsemi**" or its affiliates and/or subsidiaries in the United States and/or other countries. **onsemi** owns the rights to a number of patents, trademarks, copyrights, trade secrets, and other intellectual property. A listing of **onsemi**'s product/patent coverage may be accessed at [www.onsemi.com/site/pdf/Patent-Marking.pdf](http://www.onsemi.com/site/pdf/Patent-Marking.pdf). **onsemi** reserves the right to make changes at any time to any products or information herein, without notice. The information herein is provided "as-is" and **onsemi** makes no warranty, representation or guarantee regarding the accuracy of the information, product features, availability, functionality, or suitability of its products for any particular purpose, nor does **onsemi** assume any liability arising out of the application or use of any product or circuit, and specifically disclaims any and all liability, including without limitation special, consequential or incidental damages. Buyer is responsible for its products and applications using **onsemi** products, including compliance with all laws, regulations and safety requirements or standards, regardless of any support or applications information provided by **onsemi**. "Typical" parameters which may be provided in **onsemi** data sheets and/or specifications can and do vary in different applications and actual performance may vary over time. All operating parameters, including "Typicals" must be validated for each customer application by customer's technical experts. **onsemi** does not convey any license under any of its intellectual property rights nor the rights of others. **onsemi** products are not designed, intended, or authorized for use as a critical component in life support systems or any FDA Class 3 medical devices or medical devices with a same or similar classification in a foreign jurisdiction or any devices intended for implantation in the human body. Should Buyer purchase or use **onsemi** products for any such unintended or unauthorized application, Buyer shall indemnify and hold **onsemi** and its officers, employees, subsidiaries, affiliates, and distributors harmless against all claims, costs, damages, and expenses, and reasonable attorney fees arising out of, directly or indirectly, any claim of personal injury or death associated with such unintended or unauthorized use, even if such claim alleges that **onsemi** was negligent regarding the design or manufacture of the part. **onsemi** is an Equal Opportunity/Affirmative Action Employer. This literature is subject to all applicable copyright laws and is not for resale in any manner.

## PUBLICATION ORDERING INFORMATION

### LITERATURE FULFILLMENT:

Email Requests to: [orderlit@onsemi.com](mailto:orderlit@onsemi.com)

**onsemi Website:** [www.onsemi.com](http://www.onsemi.com)

### TECHNICAL SUPPORT

**North American Technical Support:**

Voice Mail: 1 800-282-9855 Toll Free USA/Canada

Phone: 011 421 33 790 2910

**Europe, Middle East and Africa Technical Support:**

Phone: 00421 33 790 2910

For additional information, please contact your local Sales Representative