

OLGA-S

~11° spot beam with flange

TECHNICAL SPECIFICATIONS:

Dimensions	Ø 30.0 mm
Height	18.5 mm
Fastening	glue
ROHS compliant	yes ⓘ

MATERIAL SPECIFICATIONS:

Component	Type	Material	Colour	Finish
OLGA-S	Single lens	PMMA	clear	



ORDERING INFORMATION:

Component	Qty in box	MOQ	MPQ	Box weight (kg)
C16123_OLGA-S » Box size: 476 x 273 x 292 mm	792	132	66	7.3

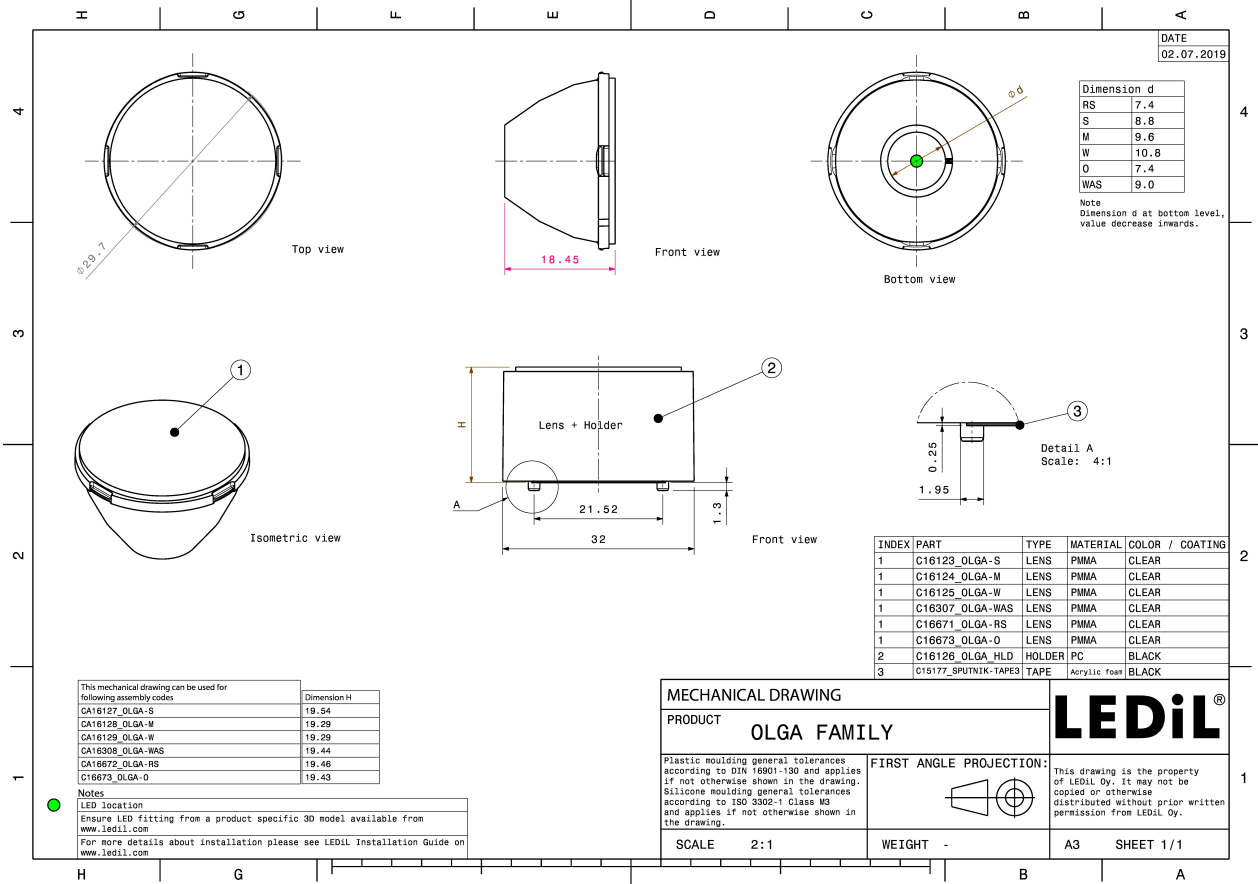

See also our general installation guide: www.ledil.com/installation_guide

PHOTOMETRIC DATA (MEASURED):

bridgelux.

LED	V4 HD
FWHM / FWTM	23.0° / 42.0°
Efficiency	85 %
Peak intensity	4.1 cd/lm
LEDs/each optic	1
Light colour	White
Required components:	



bridgelux.

LED	Vesta TW 6mm DP
FWHM / FWTM	27.0° / 54.0°
Efficiency	80 %
Peak intensity	2.5 cd/lm
LEDs/each optic	1
Light colour	White
Required components:	





CITIZEN

LED	CLU7A2 (LES 4.2mm)
FWHM / FWTM	21.0° / 43.0°
Efficiency	87 %
Peak intensity	4.3 cd/lm
LEDs/each optic	1
Light colour	White
Required components:	

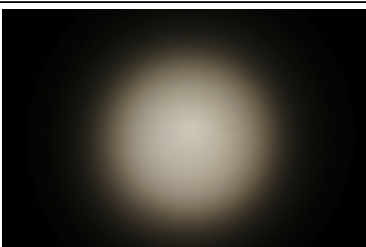
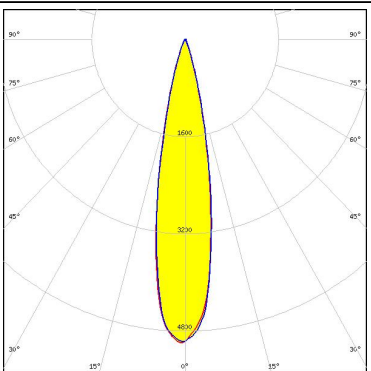

CITIZEN

LED	CLU7B2
FWHM / FWTM	21.0° / 37.0°
Efficiency	83 %
Peak intensity	5 cd/lm
LEDs/each optic	1
Light colour	White
Required components:	

PHOTOMETRIC DATA (MEASURED):





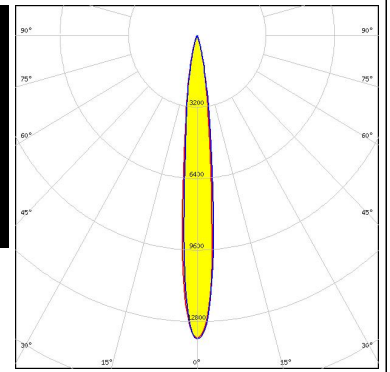

LED XP-E2
FWHM / FWTM 11.0° / 26.0°
Efficiency 89 %
Peak intensity 13.6 cd/lm
LEDs/each optic 1
Light colour White
Required components:

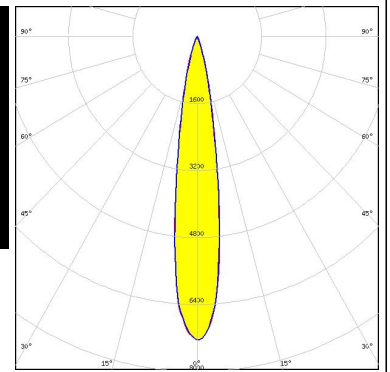

LED OSCONIQ P 3737 (3W version)
FWHM / FWTM 17.0° / 33.0°
Efficiency 86 %
Peak intensity 7.2 cd/lm
LEDs/each optic 1
Light colour White
Required components:

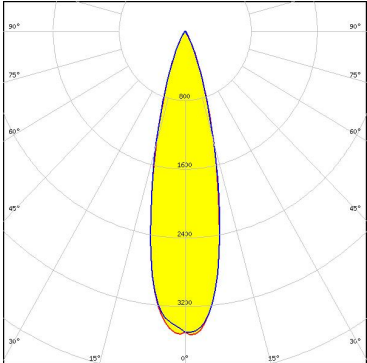
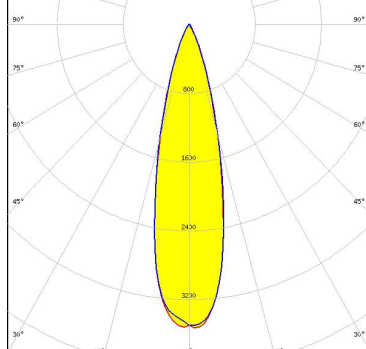
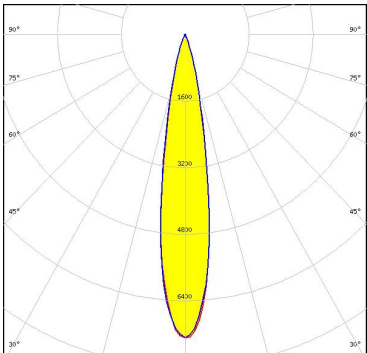
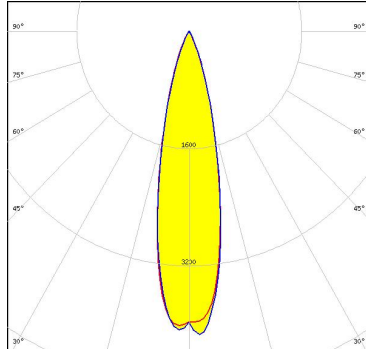

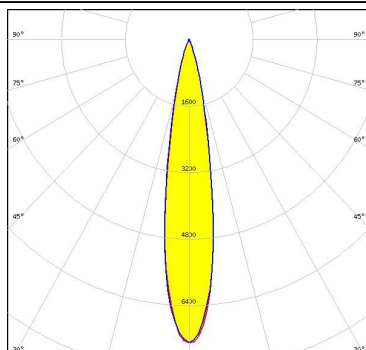
PHOTOMETRIC DATA (SIMULATED):

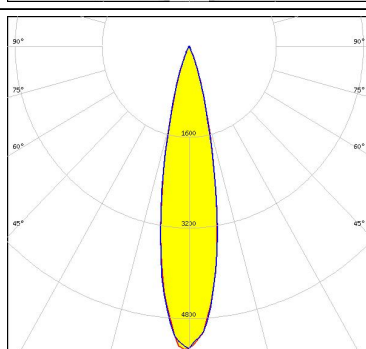
<p> bridgelux</p> <p>LED: V6 HD FWHM / FWTM: 26.0° / 48.0° Efficiency: 89 % Peak intensity: 3.5 cd/lm LEDs/each optic: 1 Light colour: White Required components:</p>	
<p> CREE LED</p> <p>LED: CXA/B 13xx FWHM / FWTM: 24.0° / 46.0° Efficiency: 92 % Peak intensity: 4.2 cd/lm LEDs/each optic: 1 Light colour: White Required components:</p>	
<p> LUMINUS</p> <p>LED: CXM-3 FWHM / FWTM: 18.0° / 34.0° Efficiency: 94 % Peak intensity: 7.3 cd/lm LEDs/each optic: 1 Light colour: White Required components:</p>	
<p> LUMINUS</p> <p>LED: CXM-4 FWHM / FWTM: 22.0° / 40.0° Efficiency: 93 % Peak intensity: 5.4 cd/lm LEDs/each optic: 1 Light colour: White Required components:</p>	

PHOTOMETRIC DATA (SIMULATED):

 SEOUL SEMICONDUCTOR		
LED	MJT COB LES 6	
FWHM / FWTM	24.0° / 47.0°	
Efficiency	92 %	
Peak intensity	3.8 cd/lm	
LEDs/each optic	1	
Light colour	White	
Required components:		
XICATO		
LED	XOB 6 mm	
FWHM / FWTM	24.0° / 47.0°	
Efficiency	90 %	
Peak intensity	3.8 cd/lm	
LEDs/each optic	1	
Light colour	White	
Required components:		



GENERAL INFORMATION:

NOTE: The typical beam angle will be changed by different color, chip size and chip position tolerance. The typical total beam angle is the full angle measured where the luminous intensity is half of the peak value.

Due to use of high power COB's with this product, special attention to proper thermal design is highly recommended. LEDiL has no liability for direct, indirect or consecutive damages arising from the LEDiL products being used outside of the recommended temperature range.

MATERIALS:

As part of our continuous research and improvement processes, and to ensure the best possible quality and availability of our products, LEDiL reserves the right to change material grades without notice.

PRODUCT DATA USER AGREEMENT AND DISCLAIMER:

The measured data in the provided downloadable LEDiL Product Datasheets and Mechanical 2D-Drawings is rounded and provided as reference for planning. LEDiL Oy's optical specifications have been verified by conducting performance testing of the products in accordance with the company's quality system. The reported data are averaged results of multiple measurements with typical variation. LEDiL Oy reserves the right to without prior notification make changes and improvements to its products.

LEDiL Oy assumes neither warranty, nor guarantee nor any other liability of any kind for the contents and correctness of the provided data. The provided data has been generated with highest diligence but the provided data may in reality not represent the complete possible variation range of all intrinsic parameters. Therefore, in certain cases a deviation from the provided data could occur.

LEDiL Oy reserves the right to undertake technical changes of its products without further notification which could lead to changes in the provided data. LEDiL Oy assumes no liability of any kind for the possible deviation from any provided data or any other damage resulting from the usage of the provided data.

The user agrees to this disclaimer and user agreement with the download or usage of the provided files.

LEDiL Oy

Joensuunkatu 13
FI-24240 SALO
Finland

LEDiL Inc.

228 West Page Street
Suite D
Sycamore IL 60178
USA

Ledil Optics Technology (Shenzhen) Co., Ltd.

405 , Block B
Casic Motor Building
Shenzhen 518057
P.R.CHINA

Local sales and technical support

[www.ledil.com/
where_to_buy](http://www.ledil.com/where_to_buy)

Shipping locations

Salo, Finland
Hong Kong, China

Distribution Partners

[www.ledil.com/
where_to_buy](http://www.ledil.com/where_to_buy)