

IsoLoop[®]
2.5 kV MSOP Isolated
Switch-Mode Power Supply
Demonstration Board

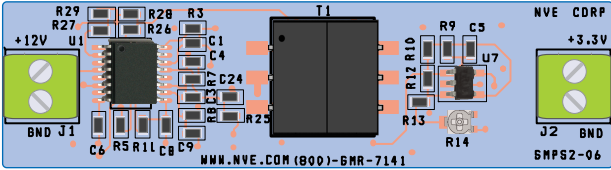

Board No.: SMPS2-01

Overview

This board demonstrates an isolated, high-efficiency synchronous buck converter switch-mode power supply (SMPS) using the world's smallest isolators, NVE IsoLoop® MSOP Isolators.

The board has three channels of isolation to ensure the output is electrically isolated from the input. A two-channel MSOP-8 isolator isolates synchronous rectification. A single-channel MSOP-8 isolator and simple voltage-to-frequency conversion circuitry provide isolated output-voltage feedback. MSOP isolators minimize board area. Despite the compact components, the transformer, isolators, and circuit board maintain at least 3 mm creepage.

Wide-body IsoLoop versions can be used with the same circuitry to provide 5 kV_{RMS} isolation and 8 mm creepage. High speed, small size, low EMI, and high reliability make IsoLoop Isolators ideal for switch-mode power supplies. A remarkable 44000-year barrier life provides MTBFs thousands of times better than optocouplers or other solid-state isolators.

Key evaluation board and isolator specifications are summarized as follows:

Evaluation Board Specifications

- Input voltage: 12 V nominal (11 V – 14 V)
- Nominal output voltage: 3.3 ± 0.05 V
- Maximum output current: 750 mA
- Overcurrent protection
- Switching frequency: ~130 kHz
- Fully isolated: 2.5 kV_{RMS} / one minute per UL1577
- 100°C operating temperature
- 3 mm creepage spacing

IsoLoop Isolator Features

- 300 ps pulse width distortion for minimal deadtime
- 100 ps pulse jitter for high precision
- 50 kV/μs transient immunity
- No carriers or internal clocks for very low EMI emissions
- 44000 year barrier life
- Package options including:
 - Ultraminiature MSOP-8 (2.5 kV_{RMS} isolation; 600 Working Voltage)
 - Industry-standard SOIC-8 (2.5 kV_{RMS} isolation; 600 Working Voltage)
 - True 8 mm creepage wide-body (5 kV_{RMS} isolation; 1000 Working Voltage)

Visit www.nve.com for IsoLoop® datasheets.

Board Layout

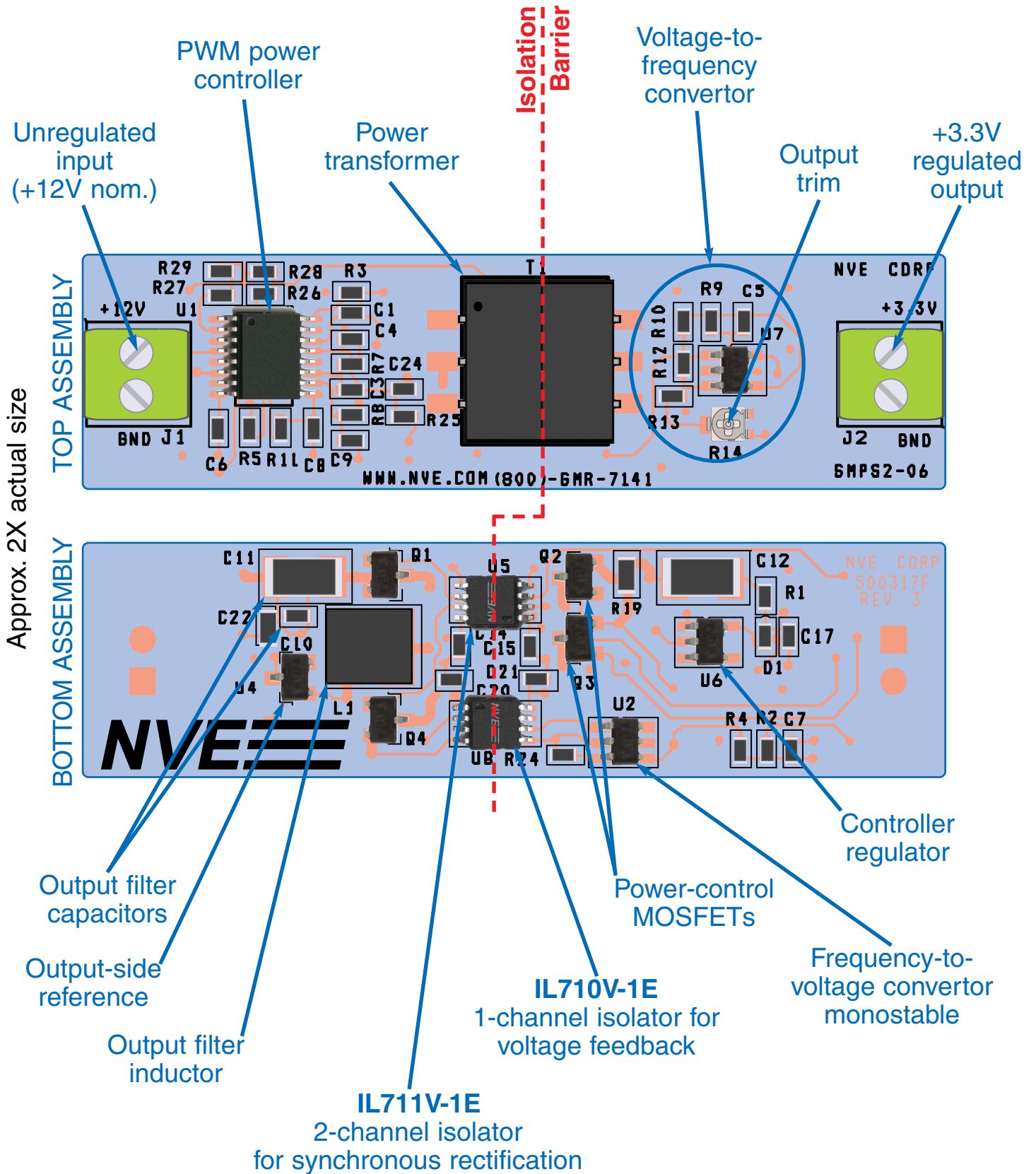

PCB Layers

Top Views
(approx. 2X actual size)

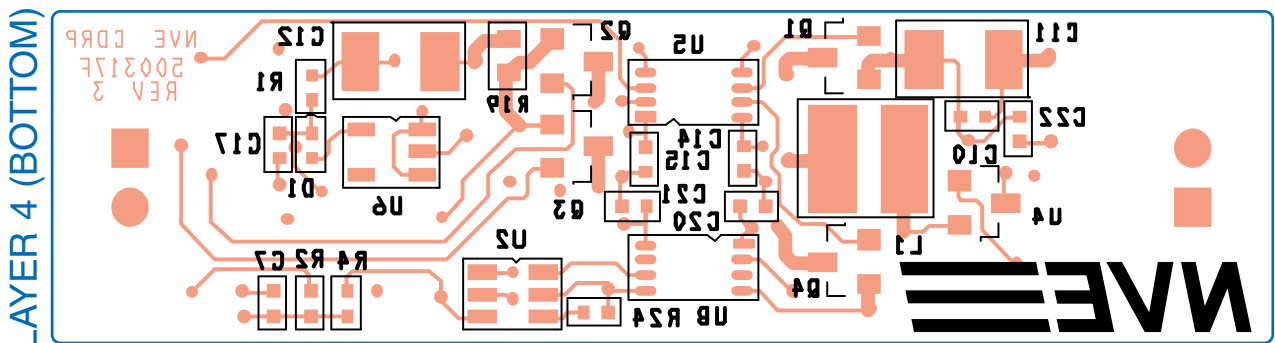
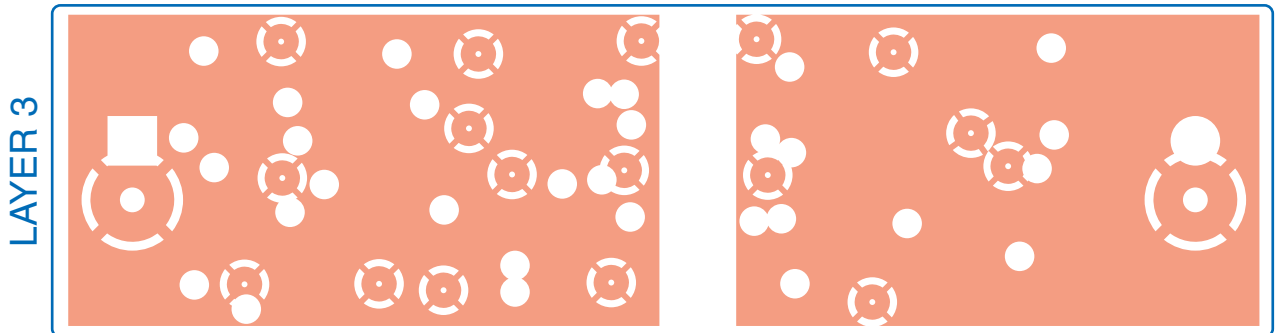
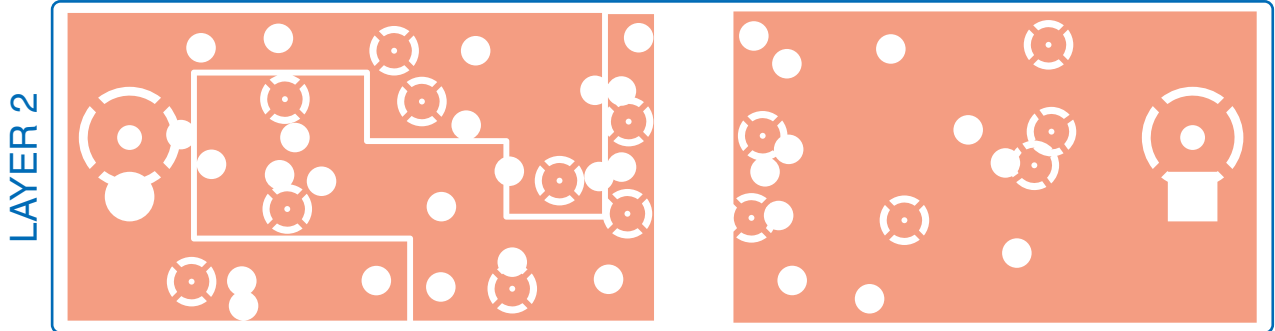
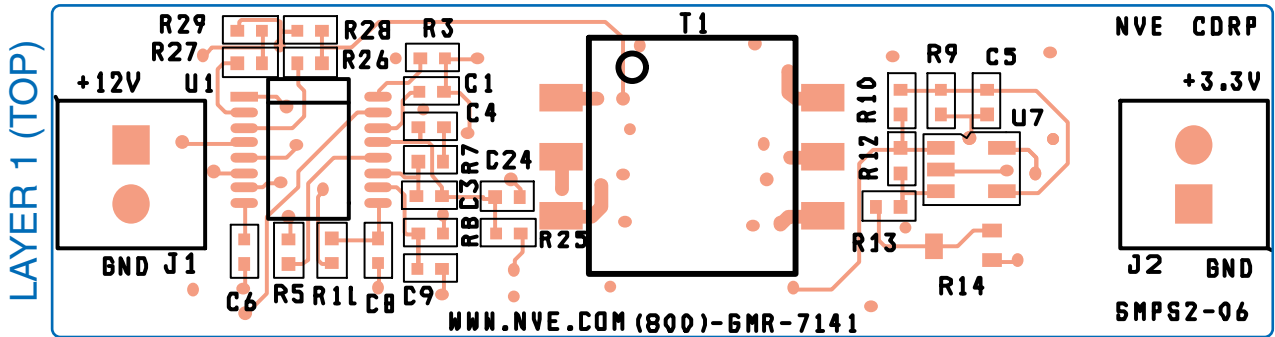

Contact iso-apps@nve.com for design files.

Bill of Materials

Reference	Qty	Part Description	Package
C5	1	100pF, 50V, 1%, NP0, 0402, 125°C	0402
C6, C8	2	270pF, 16V, 0402, 100°C	0402
C9	1	1nF, 16V, 0402, 100°C	0402
C3	1	.0056μF, 16V, 0402, 100°C	0402
C24	1	.01μF, 16V, 0402, 100°C	0402
C1, C4	2	.068μF, 16V, 0402, 100°C	0402
C7, C13, C14, C15, C19, C20, C21, C22	8	.1μF, 16V, 0402, 100°C	0402
C10, C17	2	2.2μF, 16V, 0402, 100°C	0402
C12	1	47μF, 16V, 1210, 100°C	1210
C11	1	220μF, 6.3V, 1210, 100°C	1210
D1	1	CDSQR400B Switching Diode	0402
R19	1	0.033Ω, 0603	0603
R8	1	100Ω, 0402	0402
R1	1	1.5kΩ, 0402	0402
R28, R29	2	4.99kΩ, 0402	0402
R3, R25, R26, R27	4	10kΩ, 0402	0402
R10	1	24kΩ, 0402	0402
R2, R4, R9, R24	4	47kΩ, 0402	0402
R13	1	75kΩ, 0402	0402
R7	1	100kΩ, 0402	0402
R12	1	200kΩ, 0402	0402
R11	1	300kΩ, 0402	0402
R14	1	PVA2A223A01R00 22kΩ Trimmer	SMD
R5	1	Optional (not factory installed)	0402
L1	1	22μH, 1.5A, 1816, 100°C	1816
T1	1	Transformer, 560μH, 8:3, Pulse Electronics PH9185.083NL	SMD
J1, J2	2	Screw Terminal, 2 position, 0.1"	
Q1, Q2, Q3, Q4	4	IRLML6244TRPBF MOSFET	SOT23-3
U1	1	Linear Tech LTC3723 EGN-2#PBF PWM Controller	SSOP-16
U2	1	LTC6993HS6-2 One Shot	SOT23-6
U4	1	ISL21010DFH312Z-TK 1.25V Ref	SOT23-3
U5	1	IL711V-1E 2.5 kV, 2-ch Isolator	MSOP-8
U6	1	TI LP2985-10DBVR Regulator	SOT23-5
U7	1	TI TLV3201AIDBVR Comparator	SOT23-5
U8	1	IL710V-1E 2.5 kV MSOP Isolator	MSOP-8
SMPS2-06	1	PCB	

Circuit Description

Circuit Overview

The demonstration circuit has three main sections: power control, synchronous rectification, and voltage control. The power control section modulates power to the primary of the transformer. The synchronous rectification section uses synchronously-switched MOSFETs to provide a DC output from the transformer secondary. Finally, the voltage control section controls the output by feeding back a digital signal with a frequency corresponding to the output voltage. The board has three channels of isolation to provide an electrically isolated output.

Power Control

The PWM Controller (U1) varies the duty cycle of two push-pull power-control MOSFETs (Q2 and Q3), to regulate to the desired output. The controller oscillator frequency is set by C6, in this case to around 260 kHz. The switching frequency for the push-pull and synchronous rectifier MOSFETs is half the controller frequency (roughly 130 kHz). The transformer (T1) transfers power to the secondary while maintaining isolation. The formulas for approximate switching frequency are:

$$f_{U1.8} \approx \frac{1}{(14 \text{ k}\Omega)(C6)} \quad f_{\text{SWITCH}} \approx \frac{1}{(28 \text{ k}\Omega)(C6)}$$

Powering the controller

At least 10.7 V ($V_{UVLO(MAX)}$) on V_{CC} is required for Controller start-up. Once the Controller is running, a minimum 7 V, maximum 10 V supply is needed for operation. In this circuit, a “trickle charge” through resistor R1 starts the controller. Diode D1 allows V_{CC} to go above the 10 V regulator (U6) output as required for start-up. After the Controller’s start-up cycle, its power consumption increases, so V_{CC} drops. When V_{CC} drops below approximately 9.3 V, U6 begins supplying Controller power. D1 also drops the regulator output below the 10 V absolute maximum supply to the Controller from a low-impedance source, even if the regulator is at the high end of its output specification. The minimum input voltage is a function of the Controller minimum start-up supply, Controller start-up current, and R1:

$$V_{IN(MIN)} = V_{CCUV(MAX)} + (I_{CCST(MAX)})(R1); \quad V_{CCUV(MAX)} = 10.7 \text{ V}; \quad I_{CCST(MAX)} = 250 \mu\text{A}$$

The 1.5k Ω value for R1 allows a minimum input voltage of 11.1 V. A larger resistor increases the minimum input voltage; a lower value decreases efficiency by dissipating more power. This demonstration board has a maximum input voltage maximum input voltage of 16 V, which is limited by the maximum U6 input.

In some SMPS designs, controller operating power is provided by an auxiliary transformer winding. This avoids a controller regulator at the expense of a more complicated transformer.

Circuit Description

System turn-on and turn off voltages

The controller Under-Voltage Lock-Out (UVLO) pin has a 5 V threshold. A resistor divider in this circuit sets the minimum input voltage at approximately 10 V, and a 0.1 μF capacitor sets a start-up time of several milliseconds to ensure the monostable and other components are running before switching starts.

Soft start

C1 sets a controlled ramp of the power-switching duty cycle for soft start on power up or after an overload shutdown. A 0.068 μF capacitor sets the soft-start time (t_{SS}) at approximately 25 ms:

$$t_{\text{SS}} = (385\text{k}\Omega)(C1)$$

The soft start time should be longer than the Under-Voltage Lock-Out time, and much longer than the voltage feedback cutoff frequency set by R25 and C24. With active circuitry in the feedback loop, soft start will only be effective over a limited range near the desired output.

MOSFET dead time

R5 can be used to program the “dead time,” which is the minimum time between one of the Q2 or Q3 power-control MOSFETs turning off and the other turning on. This ensures both push-pull MOSFETs are not on at the same time at high duty cycles. The resistor is omitted in this demonstration because it does not normally run at high duty cycles, so the dead time is the Controller’s default.

Current limiting

R19 sets cycle-by-cycle current limiting, as well as “hiccup mode” short-circuit protection, where the controller resets and initiates a soft-start cycle. The 0.033 Ω value sets cycle-by-cycle MOSFET current limits ($I_{\text{C-C}}$) at approximately 9 A, which provides some margin above peak operating currents. The controller sets the short-circuit protection (I_{SCP}) at twice the cycle-by-cycle limit, or 18 A in this case. The current limit calculations are:

$$I_{\text{C-C}} = \frac{0.3\text{V}}{R19} \qquad I_{\text{SCP}} = \frac{0.6\text{V}}{R19}$$

Synchronous Rectification

The controller turns on synchronous rectification MOSFETs Q1 and Q4 in synchronization with the power-control MOSFETs. This means the MOSFETs are on when their drain voltages are positive. This synchronous rectification is more efficient than diode rectification because it eliminates diodes’ inherent forward voltage losses.

[continued after schematic...]

Isolated Switch-Mode Power Supply Schematic

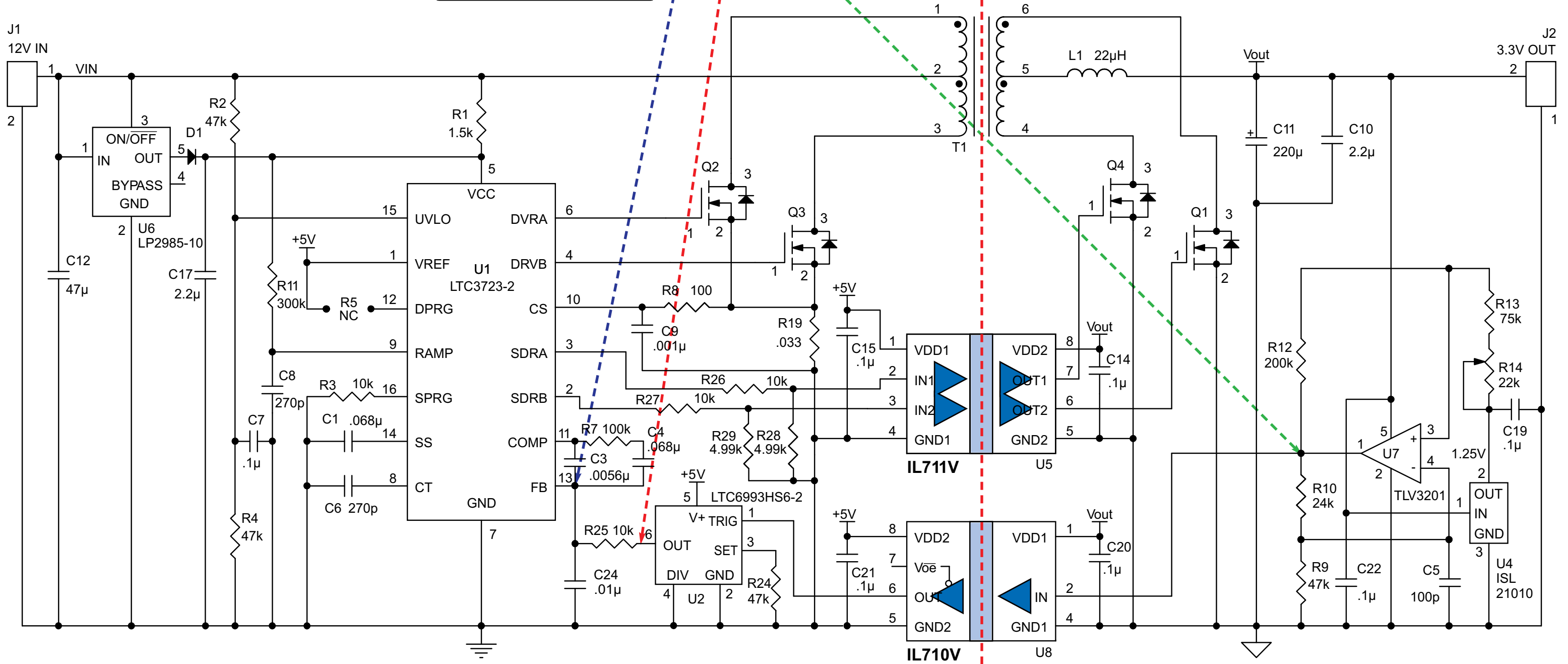
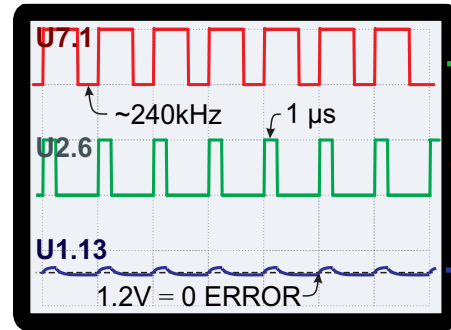

Circuit Description

Synchronous rectification isolation

An IL711V-1E two-channel isolator (U5) isolates the MOSFETs from the controller. The isolator's low pulse-width distortion minimizes deadtime and maximizes efficiency. Its speed also enables higher switching frequencies, which allows smaller inductive elements. High isolator drive capability allows high gate-charge MOSFETs.

MOSFET turn-off delay

The delay between power-control synchronous rectifier MOSFET turn-offs can be adjusted from approximately 20 ns to 200 ns with R3 values of 10 k Ω to 200 k Ω . The delay can optimize efficiency by compensating for MOSFET speeds and inductive phase shifts. This demonstration uses just a 20 ns delay because it has fast MOSFETs and a relatively small transformer.

Voltage Control

The output supply voltage is determined by three voltage references, and passive components associated with an oscillator operating as a voltage-to-frequency convertor, and a monostable operating as a frequency-to-voltage convertor. The references are 1.2 V and 5 V controller references (V_{FB} and V_{REF}), and a separate 1.25 V output-side reference (V_{U4}).

Voltage-to-frequency convertor

U7 forms a simple, single-chip relaxation oscillator with a frequency dependent on its supply voltage (the supply output) compared to the U4 output-side reference.

The sawtooth waveform on U7.4 provides the time base. The sawtooth minimum voltage is set by the reference, while its maximum depends on the output voltage:

$$V_{U7.4(MIN)} = \beta_1 V_{U4}; \quad V_{U7.4(MAX)} = V_{OUT} - \beta_1 (V_{OUT} - V_{U4})$$

$$\text{where } \beta_1 \equiv R12/(R12+R13) \text{ and } V_{U4} = 1.25 \text{ V}$$

Frequency is calculated as follows:

$$f_{U7} = \frac{1}{T_{U7.1(LOW)} + T_{U7.1(HIGH)}}; \quad T_{U7.1(LOW)} = \tau \ln \frac{V_{U7.4(MAX)}}{V_{U7.4(MIN)}}; \quad T_{U7.1(HIGH)} = \tau \ln \frac{\beta_2 V_{OUT} - V_{U7.4(MIN)}}{\beta_2 V_{OUT} - V_{U7.4(MAX)}}$$

$$\text{where } \beta_2 \equiv R9/(R9+R10) \text{ and } \tau = C5[(R9)(R10)/(R9+R10)]$$

A 240 kHz feedback frequency at the desired 3.3 V output was selected for convenience so that a 1 μ s monostable pulse will produce a 24% duty cycle, which when powered by the 5 V reference produces the desired 1.2 V controller feedback voltage. Higher frequencies allow faster feedback and better transient response but require faster comparators and monostables.

Circuit Description

The following graph shows the voltage-to-frequency convertor transfer function:

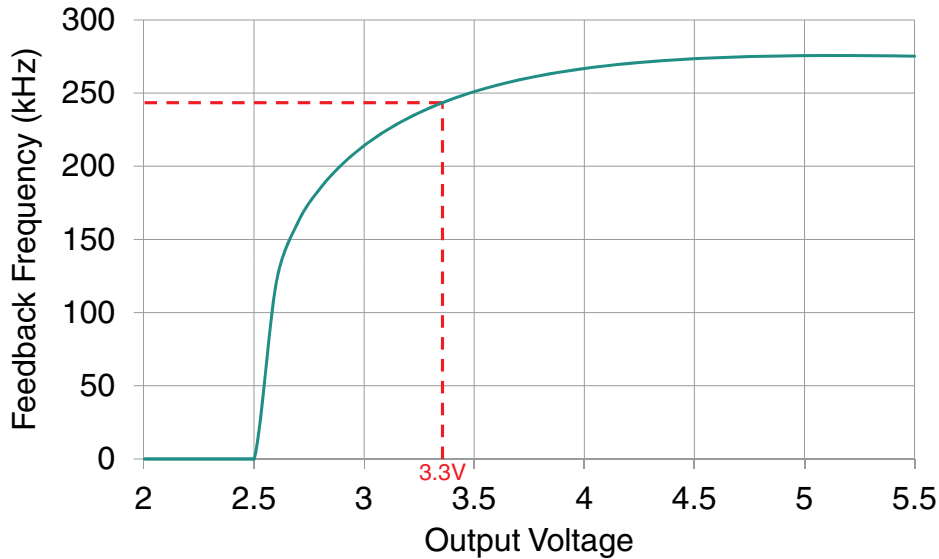

Voltage-to-frequency convertor feedback frequency vs. voltage.

The voltage-to-frequency convertor provides a two-to-one control voltage range from where the oscillator starts to where the oscillator frequency stops increasing, calculated as follows:

$$V_{\text{OUT(MIN)}} = \beta_1 V_{U4} / (\beta_1 + \beta_2 - 1); \quad V_{\text{OUT(MAX)}} = 2V_{\text{OUT(MIN)}}$$

The minimum control voltage is set around 2.5 V, which is where the output-side electronics starts operating. The desired output voltage should be well away from the minimum or maximum because the frequency dependence is highly nonlinear around the minimum, and sensitivity decreases near the maximum. More complex voltage-to-frequency designs are possible that would have a more linear response and wider control range, but because it is part of a closed-loop system, the nonlinear frequency response to voltage does not significantly degrade accuracy. The control range is sufficient for a fixed-output supply.

Feedback isolation

The feedback frequency signal is isolated by an IL710V-1E single-channel isolator (U8), which is smaller and longer life than analog optocouplers commonly used for this purpose.

Frequency-to-voltage conversion

Monostable U2 functions as a frequency-to-voltage convertor. The average monostable output voltage is proportional to the monostable pulse width, the frequency, and the Controller reference voltage powering the monostable:

$$V_{U1.13} = (V_{\text{REF}})(f_{U7})(T_{U2}); \quad V_{\text{REF}} = 5 \text{ V}$$

Circuit Description

A voltage-mode PWM Controller version is used for U1 because it is compatible with this feedback isolation scheme. The Controller compares the feedback voltage ($V_{U1.13}$) to an internal 1.2 V reference (V_{FB}). The monostable pulse width is calculated as follows:

$$T_{U2} = (R24/50 \text{ k}\Omega)(1 \mu\text{s}); T_{U2} \geq 1 \mu\text{s}$$

The monostable pulse width is selected to provide an average voltage equal to the 1.2 V Controller reference when the feedback frequency indicates the correct output voltage (previously calculated at 240 kHz in this case). The circuit is designed for the monostable's minimum 1 μs pulse width, so the R24 value is slightly less than 50 k Ω . A trim resistor on the output side can adjust the output for demonstration purposes.

Since the monostable is edge-triggered, the isolator start-up state is not a concern. An integrated monostable is used for simplicity, but faster or more accurate monostables can be made with a comparator if necessary.

Filtering and Frequency Compensation

Output filter

The output capacitor filters out ripple. In this design there are two primary ripple sources, the synchronous rectification and the voltage-to-frequency feedback. Synchronous rectification ripple is inversely proportional to twice the switching frequency (because full-wave rectification is used). Ignoring the ripple reducing effects of L1, the synchronous rectification output ripple component is estimated as follows:

$$V_{\text{RIPPLE-SWITCH}} = I_{\text{LOAD}} / [(C11)(2f_{\text{SWITCH}})]$$

A 220 μF capacitor (C11) with the 130 kHz switching frequency provides ripple of less than 10 mV at a 500 mA load. A parallel low-ESR capacitor (C10) minimizes ripple from inductive current changes.

Digital feedback filter

R25 and C24 filter the isolated feedback signal and help ensure system closed-loop stability. The filter reduces PWM-induced ripple and error amplifier noise. However, the time constant also limits transient response time.

The filter cutoff frequency should be well above the output filter and controller compensation cutoff frequencies so the closed-loop control is fast enough for stability. For the simple single-pole filter, the feedback signal ripple is approximately:

$$V_{\text{RIPPLE-U1.13}} = V_{\text{FB}} / [(R25)(C24)(f_{U7.1})]; V_{\text{FB}} = 1.2 \text{ V}$$

Circuit Description

PWM ripple will be reflected to the output but reduced by the output filter capacitor:

$$V_{\text{RIPPLE-PWM}} = (V_{\text{RIPPLE-U1.13}})(I_{\text{LOAD}})/[(V_{\text{FB}})(f_{\text{U7.1}})(C11)]; \quad V_{\text{FB}} = 1.2 \text{ V}$$

A more sophisticated filter or higher frequency feedback can be used for faster transient response.

Error amplifier gain

The controller error amplifier gain at AC frequencies well above the amplifier compensation cutoff frequency is:

$$A_{\text{ERROR-AC}} = R7 / R25$$

Higher gain provides less steady-state error at the expense of gain margin and therefore stability. The gain for this circuit was selected for a reasonable trade-off between accuracy and stability.

Controller compensation

(R7)(C4) improves accuracy and stability by increasing the DC gain. Filters created by (R25)(C24) and (R7)(C3) limit high-frequency gain to reduce ripple and improve noise immunity.

Level Shifting

System components run on three different supplies: the 9.3 V nominal controller supply, the 5 V controller reference supply, and the 3.3 V supply output. The controller's synchronous rectifier driver voltage can go as high as the controller supply, but the U5 isolator is powered from the 5 V primary-side reference supply. Therefore voltage dividers keep the isolator inputs below 5 V but above their 2.4 V minimum Logic High Input Voltage.

The synchronous rectifier MOSFETs are driven by the 3.3 V side of U5, so the MOSFETs are selected for a gate-source threshold voltage of well below 3.3 V.

Isolator U8 provides inherent level shifting between the 3.3 V feedback signal and the 5 V reference supply.

Maintaining Creepage

Creepage distances are often critical in power supplies circuits. In addition to meeting JEDEC standards, NVE isolator packages have unique creepage specifications. Recommended pad layouts are included in the isolator datasheets. Standard pad libraries, especially MSOPs, sometimes extend under the package, compromising creepage and clearance. Ground and power planes are also spaced to avoid compromising clearance.

One- and Two-Channel IL700-Series Isolators

Award-winning IsoLoop® IL700-Series Isolators are ideal for switch-mode power supplies because of their high speed, small size, low EMI, and high reliability. Two-channel isolators are popular choices for SMPS. Various grades, channel configurations and packages are available.

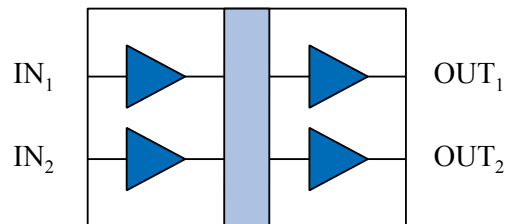
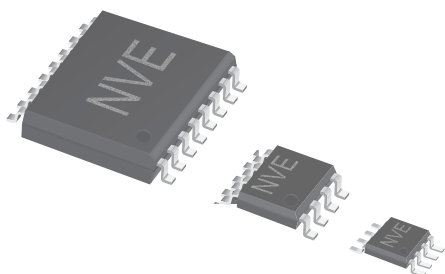

IL711

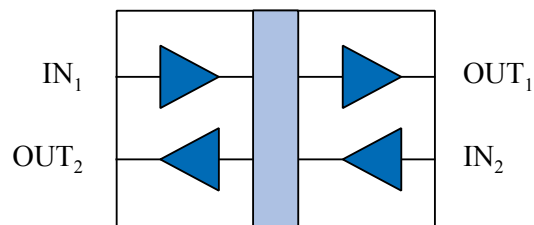

IL712

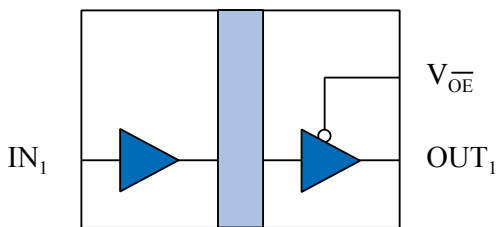

IL710

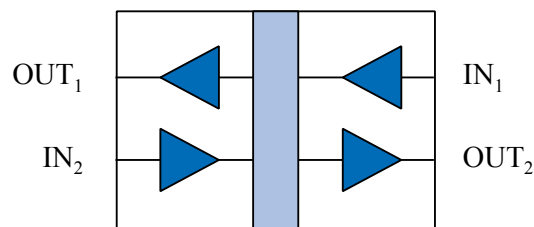

IL721

IsoLoop® Model	Transmit/Receive Channels	Isolation (per UL1577)	Max. Temp.	Key Features	Package
IL710V-1E	1/0	2500 V _{RMS}	100°C	Ultraminiature	MSOP8
IL711V-1E	2/0	2500 V _{RMS}	100°C	Ultraminiature	MSOP8
IL712V-1E	1/1	2500 V _{RMS}	100°C	Ultraminiature	MSOP8
IL710T-3E	1/0	2500 V _{RMS}	125°C	High Temperature	SOIC8
IL711T-3E	2/0	2500 V _{RMS}	125°C	High Temperature	SOIC8
IL712T-3E	1/1	2500 V _{RMS}	125°C	High Temperature	SOIC8
IL721T-3E	1/1	2500 V _{RMS}	125°C	High Temperature	SOIC8
IL711VE	2/0	5000 V _{RMS}	125°C	True 8 mm Creepage	0.3" SOIC16
IL721VE	1/1	5000 V _{RMS}	125°C	True 8 mm Creepage	0.3" SOIC16

Visit www.nve.com for datasheets.

Other NVE Isolator Evaluation Boards



IL3085-1-01: RS-485 QSOP Isolator Evaluation Board



IL3585-01: RS-485 Wide-Body Isolator Evaluation Board



IL3585-3-01: RS-485 Narrow-Body Isolator Evaluation Board

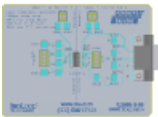

IL3685-3-01: PROFIBUS Isolator Evaluation Board



IL41050-01: Narrow-Body Isolated CAN Evaluation Board



IL41050-1-01: QSOP Isolated CAN Evaluation Board

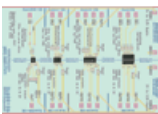

IL600-01: IL600-Series Isolator Evaluation Board

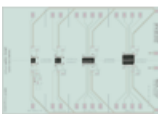

IL700-01: IL700-Series Isolator Evaluation Board

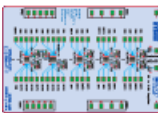

IL700-1-01: QSOP 4- and 5-Channel Isolator Evaluation Board

Order online at: www.nve.com/webstore

Limited Warranty and Liability

Information in this document is believed to be accurate and reliable. However, NVE does not give any representations or warranties, expressed or implied, as to the accuracy or completeness of such information and shall have no liability for the consequences of use of such information. In no event shall NVE be liable for any indirect, incidental, punitive, special or consequential damages (including, without limitation, lost profits, lost savings, business interruption, costs related to the removal or replacement of any products or rework charges) whether or not such damages are based on tort (including negligence), warranty, breach of contract or any other legal theory.

Right to Make Changes

NVE reserves the right to make changes to information published in this document including, without limitation, specifications and product descriptions at any time and without notice.

Use in Life-Critical or Safety-Critical Applications

Unless NVE and a customer explicitly agree otherwise in writing, NVE products are not designed, authorized or warranted to be suitable for use in life support, life-critical or safety-critical devices or equipment. NVE accepts no liability for inclusion or use of NVE products in such applications and such inclusion or use is at the customer's own risk. Should the customer use NVE products for such application whether authorized by NVE or not, the customer shall indemnify and hold NVE harmless against all claims and damages.

Applications

Applications described in this document are illustrative only. NVE makes no representation or warranty that such applications will be suitable for the specified use without further testing or modification. Customers are responsible for the design and operation of their applications and products using NVE products, and NVE accepts no liability for any assistance with applications or customer product design. It is customer's sole responsibility to determine whether the NVE product is suitable and fit for the customer's applications and products planned, as well as for the planned application and use of customer's third party customers. Customers should provide appropriate design and operating safeguards to minimize the risks associated with their applications and products. NVE does not accept any liability related to any default, damage, costs or problem which is based on any weakness or default in the customer's applications or products, or the application or use by customer's third party customers. The customer is responsible for all necessary testing for the customer's applications and products using NVE products in order to avoid a default of the applications and the products or of the application or use by customer's third party customers. NVE accepts no liability in this respect.

An ISO 9001 Certified Company

NVE Corporation
11409 Valley View Road
Eden Prairie, MN 55344-3617

©NVE Corporation

All rights are reserved. Reproduction in whole or in part is prohibited without the prior written consent of the copyright owner.

Manual No.: ISB-CB-015

April 2015