

Inductors for high frequency circuits
Multilayer ceramic
MLG series (for automotive)



AEC-Q200

MLG0603S type



FEATURES

- Advanced monolithic structure is formed using a multilayering and sintering process with ceramic and conductive materials for high-frequency.
- Operating temperature range: -55 to +125°C
- Compliant with AEC-Q200

APPLICATION

- Automotive equipment, smart phones, tablet terminals, high frequency modules (PAs, VCOs, FEMs , etc.), Bluetooth, W-LAN, UWB, tuners and other high frequency circuits for the mobile communication industry
- Application guides: [Car Infotainment](#)

PART NUMBER CONSTRUCTION

MLG	0603	S	0N3	B	T	D25
Series name	L×W×H dimensions 0.6×0.3×0.3 mm	Product internal code	Inductance (nH)	Inductance tolerance	Packaging style	Internal code



MLG0603S type

CHARACTERISTICS SPECIFICATION TABLE

L (nH)	Q Tolerance	L, Q measuring frequency min. (MHz)	Self-resonant frequency		DC resistance		Rated current (mA)max.	Part No.*	
			(GHz)min.	(GHz)typ.	(Ω)max.	(Ω)typ.			
0.3	± 0.1 nH	—	100	10.0	20up	0.1	0.02	600	MLG0603S0N3BTD25
0.3	± 0.2 nH	—	100	10.0	20up	0.1	0.02	600	MLG0603S0N3CTD25
0.4	± 0.1 nH	—	100	10.0	20up	0.1	0.02	600	MLG0603S0N4BTD25
0.4	± 0.2 nH	—	100	10.0	20up	0.1	0.02	600	MLG0603S0N4CTD25
0.5	± 0.1 nH	—	100	10.0	20up	0.1	0.02	600	MLG0603S0N5BTD25
0.5	± 0.2 nH	—	100	10.0	20up	0.1	0.02	600	MLG0603S0N5CTD25
0.6	± 0.1 nH	—	100	10.0	20up	0.1	0.02	600	MLG0603S0N6BTD25
0.6	± 0.2 nH	—	100	10.0	20up	0.1	0.02	600	MLG0603S0N6CTD25
0.7	± 0.1 nH	—	100	10.0	16.3	0.1	0.02	600	MLG0603S0N7BTD25
0.7	± 0.2 nH	—	100	10.0	16.3	0.1	0.02	600	MLG0603S0N7CTD25
0.8	± 0.1 nH	—	100	10.0	16.1	0.1	0.03	600	MLG0603S0N8BTD25
0.8	± 0.2 nH	—	100	10.0	16.1	0.1	0.03	600	MLG0603S0N8CTD25
0.9	± 0.1 nH	—	100	10.0	13.8	0.1	0.03	600	MLG0603S0N9BTD25
0.9	± 0.2 nH	—	100	10.0	13.8	0.1	0.03	600	MLG0603S0N9CTD25
1.0	± 0.1 nH	4	100	10.0	14.4	0.1	0.04	600	MLG0603S1N0BTD25
1.0	± 0.2 nH	4	100	10.0	14.4	0.1	0.04	600	MLG0603S1N0CTD25
1.0	± 0.3 nH	4	100	10.0	14.4	0.1	0.04	600	MLG0603S1N0STD25
1.1	± 0.1 nH	4	100	10.0	13.6	0.15	0.04	550	MLG0603S1N1BTD25
1.1	± 0.2 nH	4	100	10.0	13.6	0.15	0.04	550	MLG0603S1N1CTD25
1.1	± 0.3 nH	4	100	10.0	13.6	0.15	0.04	550	MLG0603S1N1STD25
1.2	± 0.1 nH	4	100	10.0	12.3	0.15	0.06	550	MLG0603S1N2BTD25
1.2	± 0.2 nH	4	100	10.0	12.3	0.15	0.06	550	MLG0603S1N2CTD25
1.2	± 0.3 nH	4	100	10.0	12.3	0.15	0.06	550	MLG0603S1N2STD25
1.3	± 0.1 nH	4	100	9.0	11.4	0.15	0.07	550	MLG0603S1N3BTD25
1.3	± 0.2 nH	4	100	9.0	11.4	0.15	0.07	550	MLG0603S1N3CTD25
1.3	± 0.3 nH	4	100	9.0	11.4	0.15	0.07	550	MLG0603S1N3STD25
1.5	± 0.1 nH	4	100	9.0	10.4	0.15	0.07	550	MLG0603S1N5BTD25
1.5	± 0.2 nH	4	100	9.0	10.4	0.15	0.07	550	MLG0603S1N5CTD25
1.5	± 0.3 nH	4	100	9.0	10.4	0.15	0.07	550	MLG0603S1N5STD25
1.6	± 0.1 nH	4	100	9.0	11.5	0.2	0.09	500	MLG0603S1N6BTD25
1.6	± 0.2 nH	4	100	9.0	11.5	0.2	0.09	500	MLG0603S1N6CTD25
1.6	± 0.3 nH	4	100	9.0	11.5	0.2	0.09	500	MLG0603S1N6STD25
1.8	± 0.1 nH	4	100	8.5	10.0	0.2	0.12	500	MLG0603S1N8BTD25
1.8	± 0.2 nH	4	100	8.5	10.0	0.2	0.12	500	MLG0603S1N8CTD25
1.8	± 0.3 nH	4	100	8.5	10.0	0.2	0.12	500	MLG0603S1N8STD25
2.0	± 0.1 nH	4	100	8.2	9.8	0.25	0.14	400	MLG0603S2N0BTD25
2.0	± 0.2 nH	4	100	8.2	9.8	0.25	0.14	400	MLG0603S2N0CTD25
2.0	± 0.3 nH	4	100	8.2	9.8	0.25	0.14	400	MLG0603S2N0STD25
2.2	± 0.1 nH	4	100	8.0	8.9	0.25	0.14	400	MLG0603S2N2BTD25
2.2	± 0.2 nH	4	100	8.0	8.9	0.25	0.14	400	MLG0603S2N2CTD25
2.2	± 0.3 nH	4	100	8.0	8.9	0.25	0.14	400	MLG0603S2N2STD25
2.4	± 0.1 nH	4	100	8.0	9.2	0.25	0.15	300	MLG0603S2N4BTD25
2.4	± 0.2 nH	4	100	8.0	9.2	0.25	0.15	300	MLG0603S2N4CTD25
2.4	± 0.3 nH	4	100	8.0	9.2	0.25	0.15	300	MLG0603S2N4STD25

*Please contact us for information on inductance tolerance, G ($\pm 2\%$).

Measurement equipment

Measurement item	Product No.	Manufacturer
L, Q	4291B+16197A	Keysight Technologies
Self-resonant frequency	8720C	Keysight Technologies
DC resistance	Type-7561	Yokogawa

* Equivalent measurement equipment may be used.

MLG0603S type

CHARACTERISTICS SPECIFICATION TABLE

L (nH)	Q Tolerance	L, Q measuring frequency min. (MHz)	Self-resonant frequency		DC resistance		Rated current (mA)max.	Part No.*	
			(GHz)min.	(GHz)typ.	(Ω)max.	(Ω)typ.			
2.7	± 0.1 nH	4	100	6.5	8.1	0.25	0.15	300	MLG0603S2N7BTD25
2.7	± 0.2 nH	4	100	6.5	8.1	0.25	0.15	300	MLG0603S2N7CTD25
2.7	± 0.3 nH	4	100	6.5	8.1	0.25	0.15	300	MLG0603S2N7STD25
3.0	± 0.1 nH	4	100	6.2	7.8	0.3	0.20	300	MLG0603S3N0BTD25
3.0	± 0.2 nH	4	100	6.2	7.8	0.3	0.20	300	MLG0603S3N0CTD25
3.0	± 0.3 nH	4	100	6.2	7.8	0.3	0.20	300	MLG0603S3N0STD25
3.3	± 0.1 nH	4	100	5.8	7.0	0.35	0.23	300	MLG0603S3N3BTD25
3.3	± 0.2 nH	4	100	5.8	7.0	0.35	0.23	300	MLG0603S3N3CTD25
3.3	± 0.3 nH	4	100	5.8	7.0	0.35	0.23	300	MLG0603S3N3STD25
3.6	± 0.1 nH	4	100	5.5	6.9	0.35	0.22	300	MLG0603S3N6BTD25
3.6	± 0.2 nH	4	100	5.5	6.9	0.35	0.22	300	MLG0603S3N6CTD25
3.6	± 0.3 nH	4	100	5.5	6.9	0.35	0.22	300	MLG0603S3N6STD25
3.9	± 0.1 nH	5	100	5.0	6.6	0.4	0.27	300	MLG0603S3N9BTD25
3.9	± 0.2 nH	5	100	5.0	6.6	0.4	0.27	300	MLG0603S3N9CTD25
3.9	± 0.3 nH	5	100	5.0	6.6	0.4	0.27	300	MLG0603S3N9STD25
4.3	± 0.3 nH	5	100	5.0	6.4	0.4	0.27	300	MLG0603S4N3STD25
4.3	$\pm 3\%$	5	100	5.0	6.4	0.4	0.27	300	MLG0603S4N3HTD25
4.7	± 0.3 nH	5	100	4.5	5.4	0.45	0.28	300	MLG0603S4N7STD25
4.7	$\pm 3\%$	5	100	4.5	5.4	0.45	0.28	300	MLG0603S4N7HTD25
5.1	± 0.3 nH	5	100	4.5	5.5	0.45	0.23	250	MLG0603S5N1STD25
5.1	$\pm 3\%$	5	100	4.5	5.5	0.45	0.23	250	MLG0603S5N1HTD25
5.6	± 0.3 nH	5	100	4.2	5.3	0.5	0.31	250	MLG0603S5N6STD25
5.6	$\pm 3\%$	5	100	4.2	5.3	0.5	0.31	250	MLG0603S5N6HTD25
6.2	± 0.3 nH	5	100	4.2	5.1	0.55	0.32	250	MLG0603S6N2STD25
6.2	$\pm 3\%$	5	100	4.2	5.1	0.55	0.32	250	MLG0603S6N2HTD25
6.8	$\pm 3\%$	5	100	3.6	4.4	0.6	0.32	250	MLG0603S6N8HTD25
6.8	$\pm 5\%$	5	100	3.6	4.4	0.6	0.32	250	MLG0603S6N8JTD25
7.5	$\pm 3\%$	5	100	4.2	5.3	0.7	0.43	200	MLG0603S7N5HTD25
7.5	$\pm 5\%$	5	100	4.2	5.3	0.7	0.43	200	MLG0603S7N5JTD25
8.2	$\pm 3\%$	5	100	3.8	4.5	0.7	0.45	200	MLG0603S8N2HTD25
8.2	$\pm 5\%$	5	100	3.8	4.5	0.7	0.45	200	MLG0603S8N2JTD25
9.1	$\pm 3\%$	5	100	3.4	4.9	0.8	0.51	200	MLG0603S9N1HTD25
9.1	$\pm 5\%$	5	100	3.4	4.9	0.8	0.51	200	MLG0603S9N1JTD25
10	$\pm 3\%$	5	100	3.2	4.1	0.8	0.53	200	MLG0603S10NHTD25
10	$\pm 5\%$	5	100	3.2	4.1	0.8	0.53	200	MLG0603S10NJTD25
11	$\pm 3\%$	6	100	3.0	3.7	0.8	0.53	200	MLG0603S11NHTD25
11	$\pm 5\%$	6	100	3.0	3.7	0.8	0.53	200	MLG0603S11NJTD25
12	$\pm 3\%$	6	100	2.8	3.6	0.9	0.63	180	MLG0603S12NHTD25
12	$\pm 5\%$	6	100	2.8	3.6	0.9	0.63	180	MLG0603S12NJTD25
13	$\pm 3\%$	6	100	2.7	3.4	0.9	0.60	180	MLG0603S13NHTD25
13	$\pm 5\%$	6	100	2.7	3.4	0.9	0.60	180	MLG0603S13NJTD25
15	$\pm 3\%$	6	100	2.5	3.3	1.1	0.69	180	MLG0603S15NHTD25
15	$\pm 5\%$	6	100	2.5	3.3	1.1	0.69	180	MLG0603S15NJTD25
16	$\pm 3\%$	6	100	2.3	3.0	1.1	0.70	180	MLG0603S16NHTD25
16	$\pm 5\%$	6	100	2.3	3.0	1.1	0.70	180	MLG0603S16NJTD25
18	$\pm 3\%$	6	100	2.2	2.8	1.2	0.78	150	MLG0603S18NHTD25
18	$\pm 5\%$	6	100	2.2	2.8	1.2	0.78	150	MLG0603S18NJTD25

* Please contact us for information on inductance tolerance, G ($\pm 2\%$).

Measurement equipment

Measurement item	Product No.	Manufacturer
L, Q	4291B+16197A	Keysight Technologies
Self-resonant frequency	8720C	Keysight Technologies
DC resistance	Type-7561	Yokogawa

* Equivalent measurement equipment may be used.

MLG0603S type

CHARACTERISTICS SPECIFICATION TABLE

L (nH)	Q Tolerance	L, Q measuring frequency min. (MHz)	Self-resonant frequency		DC resistance		Rated current (mA)max.	Part No.*	
			(GHz)min.	(GHz)typ.	(Ω)max.	(Ω)typ.			
20	$\pm 3\%$	6	100	2.1	2.6	1.2	0.75	150	MLG0603S20NHTD25
20	$\pm 5\%$	6	100	2.1	2.6	1.2	0.75	150	MLG0603S20NJTD25
22	$\pm 3\%$	6	100	2.0	2.5	1.2	0.88	150	MLG0603S22NHTD25
22	$\pm 5\%$	6	100	2.0	2.5	1.2	0.88	150	MLG0603S22NJTD25
24	$\pm 3\%$	6	100	1.9	2.3	1.3	0.90	150	MLG0603S24NHTD25
24	$\pm 5\%$	6	100	1.9	2.3	1.3	0.90	150	MLG0603S24NJTD25
27	$\pm 3\%$	6	100	1.8	2.2	1.5	1.00	100	MLG0603S27NHTD25
27	$\pm 5\%$	6	100	1.8	2.2	1.5	1.00	100	MLG0603S27NJTD25
30	$\pm 3\%$	6	100	1.6	2.0	1.6	0.95	100	MLG0603S30NHTD25
30	$\pm 5\%$	6	100	1.6	2.0	1.6	0.95	100	MLG0603S30NJTD25
33	$\pm 3\%$	6	100	1.6	2.0	1.8	1.20	100	MLG0603S33NHTD25
33	$\pm 5\%$	6	100	1.6	2.0	1.8	1.20	100	MLG0603S33NJTD25
36	$\pm 3\%$	6	100	1.5	1.8	2.0	1.68	50	MLG0603S36NHTD25
36	$\pm 5\%$	6	100	1.5	1.8	2.0	1.68	50	MLG0603S36NJTD25
39	$\pm 3\%$	6	100	1.4	1.6	2.0	1.40	50	MLG0603S39NHTD25
39	$\pm 5\%$	6	100	1.4	1.6	2.0	1.40	50	MLG0603S39NJTD25
43	$\pm 3\%$	6	100	1.3	1.6	2.2	1.91	50	MLG0603S43NHTD25
43	$\pm 5\%$	6	100	1.3	1.6	2.2	1.91	50	MLG0603S43NJTD25
47	$\pm 3\%$	6	100	1.3	1.5	2.2	1.48	50	MLG0603S47NHTD25
47	$\pm 5\%$	6	100	1.3	1.5	2.2	1.48	50	MLG0603S47NJTD25
51	$\pm 3\%$	5	100	1.2	1.5	2.8	1.98	50	MLG0603S51NHTD25
51	$\pm 5\%$	5	100	1.2	1.5	2.8	1.98	50	MLG0603S51NJTD25
56	$\pm 3\%$	5	100	1.2	1.4	3.2	2.11	50	MLG0603S56NHTD25
56	$\pm 5\%$	5	100	1.2	1.4	3.2	2.11	50	MLG0603S56NJTD25
62	$\pm 3\%$	5	100	1.1	1.3	3.3	2.22	50	MLG0603S62NHTD25
62	$\pm 5\%$	5	100	1.1	1.3	3.3	2.22	50	MLG0603S62NJTD25
68	$\pm 3\%$	5	100	1.1	1.2	3.5	2.40	50	MLG0603S68NHTD25
68	$\pm 5\%$	5	100	1.0	1.2	3.5	2.40	50	MLG0603S68NJTD25
75	$\pm 3\%$	5	100	1.0	1.2	3.8	2.67	50	MLG0603S75NHTD25
75	$\pm 5\%$	5	100	0.9	1.1	3.8	2.67	50	MLG0603S75NJTD25
82	$\pm 3\%$	5	100	0.9	1.1	4.0	2.80	50	MLG0603S82NHTD25
82	$\pm 5\%$	5	100	0.8	0.9	4.0	2.80	50	MLG0603S82NJTD25
91	$\pm 3\%$	5	100	0.8	0.9	4.3	2.97	50	MLG0603S91NHTD25
91	$\pm 5\%$	5	100	0.8	0.9	4.3	2.97	50	MLG0603S91NJTD25
100	$\pm 3\%$	5	100	0.8	0.9	4.5	3.13	50	MLG0603SR10HTD25
100	$\pm 5\%$	5	100	0.8	0.9	4.5	3.13	50	MLG0603SR10JTD25
110	$\pm 3\%$	5	100	0.8	0.9	6.5	5.24	50	MLG0603SR11HTD25
110	$\pm 5\%$	5	100	0.7	0.9	6.5	5.24	50	MLG0603SR11JTD25
120	$\pm 3\%$	5	100	0.7	0.9	7.0	5.53	50	MLG0603SR12HTD25
120	$\pm 5\%$	5	100	0.7	0.8	7.0	5.53	50	MLG0603SR12JTD25
130	$\pm 3\%$	5	100	0.7	0.8	7.3	5.68	50	MLG0603SR13HTD25
130	$\pm 5\%$	5	100	1.1	1.2	7.3	5.68	50	MLG0603SR13JTD25
150	$\pm 3\%$	5	100	0.64	0.77	8.0	6.24	50	MLG0603SR15HTD25
150	$\pm 5\%$	5	100	0.64	0.77	8.0	6.24	50	MLG0603SR15JTD25
160	$\pm 3\%$	5	100	0.60	0.73	8.3	6.67	50	MLG0603SR16HTD25
160	$\pm 5\%$	5	100	0.60	0.73	8.3	6.67	50	MLG0603SR16JTD25
180	$\pm 3\%$	5	100	0.56	0.68	8.5	6.99	50	MLG0603SR18HTD25
180	$\pm 5\%$	5	100	0.56	0.68	8.5	6.99	50	MLG0603SR18JTD25

* Please contact us for information on inductance tolerance, G ($\pm 2\%$).

Measurement equipment

Measurement item	Product No.	Manufacturer
L, Q	4291B+16197A	Keysight Technologies
Self-resonant frequency	8720C	Keysight Technologies
DC resistance	Type-7561	Yokogawa

* Equivalent measurement equipment may be used.

MLG0603S type

L, Q FREQUENCY CHARACTERISTICS TABLE

L(nH)typ.					Q typ.					Part No.*
500MHz	800MHz	1.8GHz	2.0GHz	2.4GHz	500MHz	800MHz	1.8GHz	2.0GHz	2.4GHz	
0.3	0.3	0.3	0.3	0.3	14min.	18min.	29min.	32min.	35min.	MLG0603S0N3BTD25
0.3	0.3	0.3	0.3	0.3	14min.	18min.	29min.	32min.	35min.	MLG0603S0N3CTD25
0.4	0.4	0.4	0.4	0.4	14min.	18min.	29min.	32min.	35min.	MLG0603S0N4BTD25
0.4	0.4	0.4	0.4	0.4	14min.	18min.	29min.	32min.	35min.	MLG0603S0N4CTD25
0.5	0.5	0.5	0.5	0.5	14	18	29	32	35	MLG0603S0N5BTD25
0.5	0.5	0.5	0.5	0.5	14	18	29	32	35	MLG0603S0N5CTD25
0.6	0.6	0.5	0.5	0.5	16	20	33	34	39	MLG0603S0N6BTD25
0.6	0.6	0.5	0.5	0.5	16	20	33	34	39	MLG0603S0N6CTD25
0.7	0.6	0.6	0.6	0.6	16	21	33	35	39	MLG0603S0N7BTD25
0.7	0.6	0.6	0.6	0.6	16	21	33	35	39	MLG0603S0N7CTD25
0.7	0.7	0.7	0.7	0.7	15	20	32	34	38	MLG0603S0N8BTD25
0.7	0.7	0.7	0.7	0.7	15	20	32	34	38	MLG0603S0N8CTD25
0.8	0.8	0.8	0.8	0.8	15	19	30	32	35	MLG0603S0N9BTD25
0.8	0.8	0.8	0.8	0.8	15	19	30	32	35	MLG0603S0N9CTD25
0.9	0.9	0.9	0.9	0.9	14	18	29	30	34	MLG0603S1N0BTD25
0.9	0.9	0.9	0.9	0.9	14	18	29	30	34	MLG0603S1N0CTD25
0.9	0.9	0.9	0.9	0.9	14	18	29	30	34	MLG0603S1N0STD25
1.0	1.0	1.0	1.0	1.0	14	19	29	31	34	MLG0603S1N1BTD25
1.0	1.0	1.0	1.0	1.0	14	19	29	31	34	MLG0603S1N1CTD25
1.0	1.0	1.0	1.0	1.0	14	19	29	31	34	MLG0603S1N1STD25
1.1	1.1	1.1	1.1	1.1	14	18	29	30	34	MLG0603S1N2BTD25
1.1	1.1	1.1	1.1	1.1	14	18	29	30	34	MLG0603S1N2CTD25
1.1	1.1	1.1	1.1	1.1	14	18	29	30	34	MLG0603S1N2STD25
1.2	1.2	1.2	1.2	1.2	14	18	29	30	33	MLG0603S1N3BTD25
1.2	1.2	1.2	1.2	1.2	14	18	29	30	33	MLG0603S1N3CTD25
1.2	1.2	1.2	1.2	1.2	14	18	29	30	33	MLG0603S1N3STD25
1.4	1.4	1.4	1.4	1.4	15	19	29	30	34	MLG0603S1N5BTD25
1.4	1.4	1.4	1.4	1.4	15	19	29	30	34	MLG0603S1N5CTD25
1.4	1.4	1.4	1.4	1.4	15	19	29	30	34	MLG0603S1N5STD25
1.5	1.5	1.5	1.5	1.5	14	18	29	30	33	MLG0603S1N6BTD25
1.5	1.5	1.5	1.5	1.5	14	18	29	30	33	MLG0603S1N6CTD25
1.5	1.5	1.5	1.5	1.5	14	18	29	30	33	MLG0603S1N6STD25
1.7	1.7	1.7	1.7	1.7	15	19	29	30	33	MLG0603S1N8BTD25
1.7	1.7	1.7	1.7	1.7	15	19	29	30	33	MLG0603S1N8CTD25
1.7	1.7	1.7	1.7	1.7	15	19	29	30	33	MLG0603S1N8STD25
1.9	1.9	1.9	1.9	1.9	14	18	28	29	32	MLG0603S2N0BTD25
1.9	1.9	1.9	1.9	1.9	14	18	28	29	32	MLG0603S2N0CTD25
1.9	1.9	1.9	1.9	1.9	14	18	28	29	32	MLG0603S2N0STD25
2.1	2	2.1	2.1	2.1	14	18	27	28	31	MLG0603S2N2BTD25
2.1	2	2.1	2.1	2.1	14	18	27	28	31	MLG0603S2N2CTD25
2.1	2	2.1	2.1	2.1	14	18	27	28	31	MLG0603S2N2STD25
2.2	2.2	2.2	2.3	2.3	14	18	27	29	32	MLG0603S2N4BTD25
2.2	2.2	2.2	2.3	2.3	14	18	27	29	32	MLG0603S2N4CTD25
2.2	2.2	2.2	2.3	2.3	14	18	27	29	32	MLG0603S2N4STD25

* Please contact us for information on inductance tolerance, G ($\pm 2\%$).

Measurement equipment

Product No.	Manufacturer
4291B+16197A	Keysight Technologies

* Equivalent measurement equipment may be used.

MLG0603S type

L, Q FREQUENCY CHARACTERISTICS TABLE

L(nH)typ.					Q typ.					Part No.*
500MHz	800MHz	1.8GHz	2.0GHz	2.4GHz	500MHz	800MHz	1.8GHz	2.0GHz	2.4GHz	
2.5	2.5	2.6	2.6	2.7	15	19	28	29	31	MLG0603S2N7BTD25
2.5	2.5	2.6	2.6	2.7	15	19	28	29	31	MLG0603S2N7CTD25
2.5	2.5	2.6	2.6	2.7	15	19	28	29	31	MLG0603S2N7STD25
2.8	2.8	2.9	2.9	3	15	19	29	31	33	MLG0603S3N0BTD25
2.8	2.8	2.9	2.9	3	15	19	29	31	33	MLG0603S3N0CTD25
2.8	2.8	2.9	2.9	3	15	19	29	31	33	MLG0603S3N0STD25
3.1	3.1	3.2	3.3	3.4	15	19	28	29	31	MLG0603S3N3BTD25
3.1	3.1	3.2	3.3	3.4	15	19	28	29	31	MLG0603S3N3CTD25
3.1	3.1	3.2	3.3	3.4	15	19	28	29	31	MLG0603S3N3STD25
3.4	3.4	3.5	3.6	3.7	14	18	26	27	29	MLG0603S3N6BTD25
3.4	3.4	3.5	3.6	3.7	14	18	26	27	29	MLG0603S3N6CTD25
3.4	3.4	3.5	3.6	3.7	14	18	26	27	29	MLG0603S3N6STD25
3.7	3.7	3.8	3.9	4.1	15	19	29	29	32	MLG0603S3N9BTD25
3.7	3.7	3.8	3.9	4.1	15	19	29	29	32	MLG0603S3N9CTD25
3.7	3.7	3.8	3.9	4.1	15	19	29	29	32	MLG0603S3N9STD25
4.1	4.1	4.3	4.4	4.6	14	18	27	27	29	MLG0603S4N3HTD25
4.1	4.1	4.3	4.4	4.6	14	18	27	27	29	MLG0603S4N3STD25
4.4	4.4	4.8	4.9	5.2	15	20	28	29	30	MLG0603S4N7STD25
4.4	4.4	4.8	4.9	5.2	15	20	28	29	30	MLG0603S4N7HTD25
4.8	4.8	5.1	5.3	5.6	14	18	25	26	27	MLG0603S5N1HTD25
4.8	4.8	5.1	5.3	5.6	14	18	25	26	27	MLG0603S5N1STD25
5.3	5.3	5.7	5.9	6.4	16	20	27	28	29	MLG0603S5N6STD25
5.3	5.3	5.7	5.9	6.4	16	20	27	28	29	MLG0603S5N6HTD25
5.9	5.9	6.5	6.8	7.5	15	18	25	25	26	MLG0603S6N2STD25
5.9	5.9	6.5	6.8	7.5	15	18	25	25	26	MLG0603S6N2HTD25
6.4	6.5	7.4	7.8	8.7	15	19	26	26	25	MLG0603S6N8HTD25
6.4	6.5	7.4	7.8	8.7	15	19	26	26	25	MLG0603S6N8JTD25
7.1	7.1	7.8	8	8.7	14	18	25	26	26	MLG0603S7N5HTD25
7.1	7.1	7.8	8	8.7	14	18	25	26	26	MLG0603S7N5JTD25
7.8	7.8	8.8	9.3	10.4	15	18	24	24	24	MLG0603S8N2HTD25
7.8	7.8	8.8	9.3	10.4	15	18	24	24	24	MLG0603S8N2JTD25
8.6	8.6	9.8	10.3	11.5	14	17	22	22	22	MLG0603S9N1HTD25
8.6	8.6	9.8	10.3	11.5	14	17	22	22	22	MLG0603S9N1JTD25
10	10	12	12	15	15	18	23	22	21	MLG0603S10NHTD25
10	10	12	12	15	15	18	23	22	21	MLG0603S10NJTD25
10	11	13	14	16	15	18	22	22	20	MLG0603S11NHTD25
10	11	13	14	16	15	18	22	22	20	MLG0603S11NJTD25
11	12	14	15	19	16	19	24	23	20	MLG0603S12NHTD25
11	12	14	15	19	16	19	24	23	20	MLG0603S12NJTD25
12	13	16	17	22	14	16	19	18	15	MLG0603S13NHTD25
12	13	16	17	22	14	16	19	18	15	MLG0603S13NJTD25

* Please contact us for information on inductance tolerance, G ($\pm 2\%$).

Measurement equipment

Product No.	Manufacturer
4291B+16197A	Keysight Technologies

* Equivalent measurement equipment may be used.

MLG0603S type

L, Q FREQUENCY CHARACTERISTICS TABLE

L(nH)typ.					Q typ.					Part No.*
500MHz	800MHz	1.8GHz	2.0GHz	2.4GHz	500MHz	800MHz	1.8GHz	2.0GHz	2.4GHz	
14	15	20	23	33	15	19	20	18	14	MLG0603S15NHTD25
14	15	20	23	33	15	19	20	18	14	MLG0603S15NJTD25
15	16	22	25	37	14	16	16	15	11	MLG0603S16NHTD25
15	16	22	25	37	14	16	16	15	11	MLG0603S16NJTD25
17	18	28	35		14	17	15	13		MLG0603S18NHTD25
17	18	28	35		14	17	15	13		MLG0603S18NJTD25
19	20	32			13	16	14			MLG0603S20NHTD25
19	20	32			13	16	14			MLG0603S20NJTD25
21	23	40			15	17	13			MLG0603S22NHTD25
21	23	40			15	17	13			MLG0603S22NJTD25
23	24	45			13	15	13			MLG0603S24NHTD25
23	24	45			13	15	13			MLG0603S24NJTD25
27	29				15	17				MLG0603S27NHTD25
27	29				15	17				MLG0603S27NJTD25
29	32				13	15				MLG0603S30NHTD25
29	32				13	15				MLG0603S30NJTD25
33	36				14	16				MLG0603S33NHTD25
33	36				14	16				MLG0603S33NJTD25
36	40				14	15				MLG0603S36NHTD25
36	40				14	15				MLG0603S36NJTD25
40	47				13	14				MLG0603S39NHTD25
40	47				13	14				MLG0603S39NJTD25
44	53				14	14				MLG0603S43NHTD25
44	53				14	14				MLG0603S43NJTD25
49	60				13	13				MLG0603S47NHTD25
49	60				13	13				MLG0603S47NJTD25
52	64				11	11				MLG0603S51NHTD25
52	64				11	11				MLG0603S51NJTD25
59	77				12	11				MLG0603S56NHTD25
59	77				12	11				MLG0603S56NJTD25
66	88				11	10				MLG0603S62NHTD25
66	88				11	10				MLG0603S62NJTD25
74	104				13	11				MLG0603S68NHTD25
74	104				13	11				MLG0603S68NJTD25
82	119				10	8				MLG0603S75NHTD25
82	119				10	8				MLG0603S75NJTD25
96	161				12	8				MLG0603S82NHTD25
96	161				12	8				MLG0603S82NJTD25
109					9					MLG0603S91NHTD25
109					9					MLG0603S91NJTD25
129					11					MLG0603SR10HTD25
129					11					MLG0603SR10JTD25

* Please contact us for information on inductance tolerance, G ($\pm 2\%$).

Measurement equipment

Product No.	Manufacturer
4291B+16197A	Keysight Technologies

* Equivalent measurement equipment may be used.

MLG0603S type

L, Q FREQUENCY CHARACTERISTICS TABLE

L(nH)typ.					Q typ.					Part No.*
500MHz	800MHz	1.8GHz	2.0GHz	2.4GHz	500MHz	800MHz	1.8GHz	2.0GHz	2.4GHz	
134					10					MLG0603SR11HTD25
134					10					MLG0603SR11JTD25
156					9					MLG0603SR12HTD25
156					9					MLG0603SR12JTD25
172					8					MLG0603SR13HTD25
172					8					MLG0603SR13JTD25
223					7					MLG0603SR15HTD25
223					7					MLG0603SR15JTD25
238					7					MLG0603SR16HTD25
238					7					MLG0603SR16JTD25
318					6					MLG0603SR18HTD25
318					6					MLG0603SR18JTD25

* Please contact us for information on inductance tolerance, G ($\pm 2\%$).

Measurement equipment

Product No.	Manufacturer
4291B+16197A	Keysight Technologies

* Equivalent measurement equipment may be used.

MLG0603S type

L FREQUENCY CHARACTERISTICS (EXAMPLE)

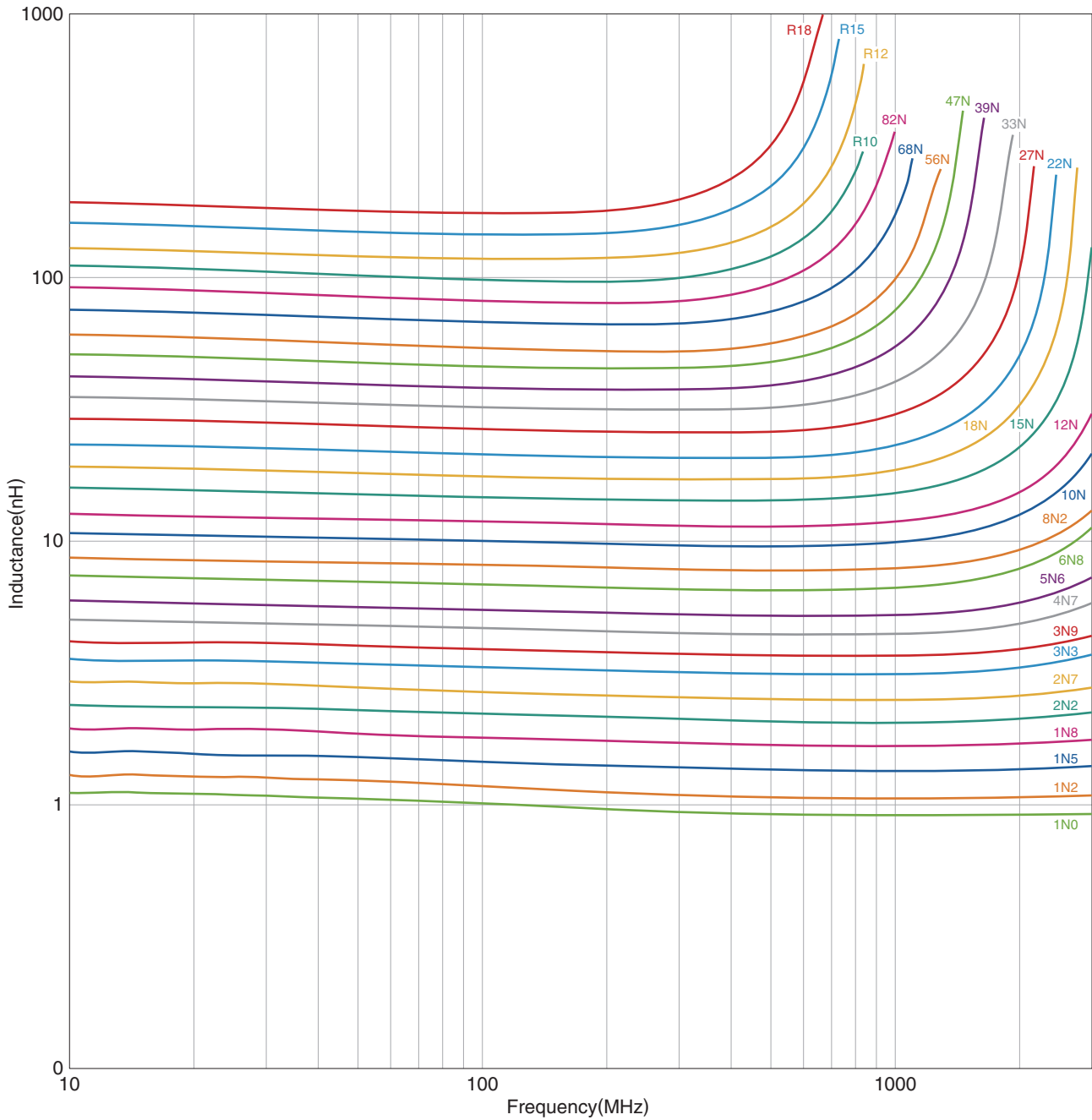

Measurement equipment

Product No.	Manufacturer
E4991A +16197A	Keysight Technologies

* Equivalent measurement equipment may be used.

MLG0603S type

Q FREQUENCY CHARACTERISTICS (EXAMPLE)

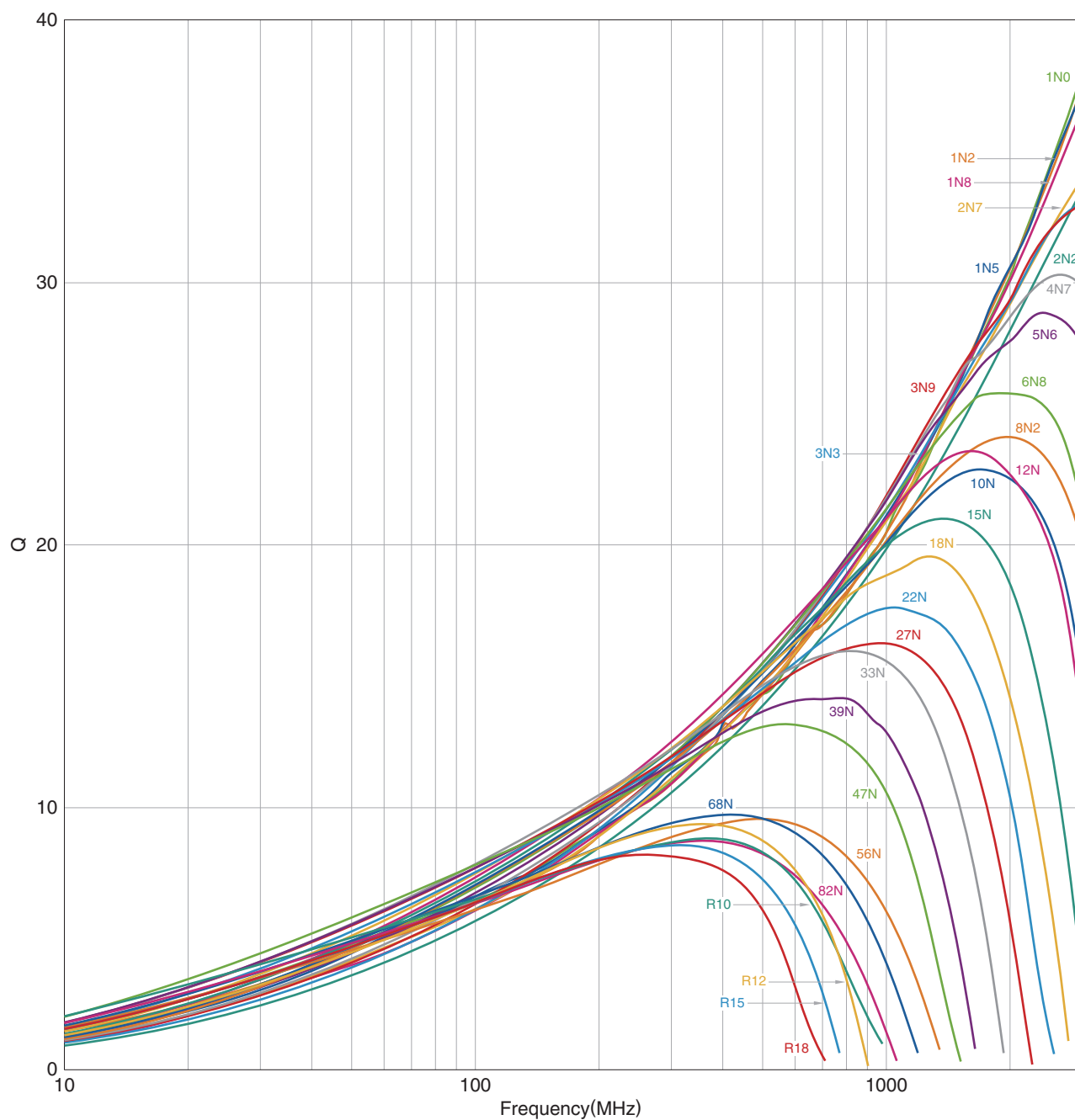

Measurement equipment

Product No.	Manufacturer
E4991A +16197A	Keysight Technologies

* Equivalent measurement equipment may be used.

MLG0603S type

SHAPE & DIMENSIONS

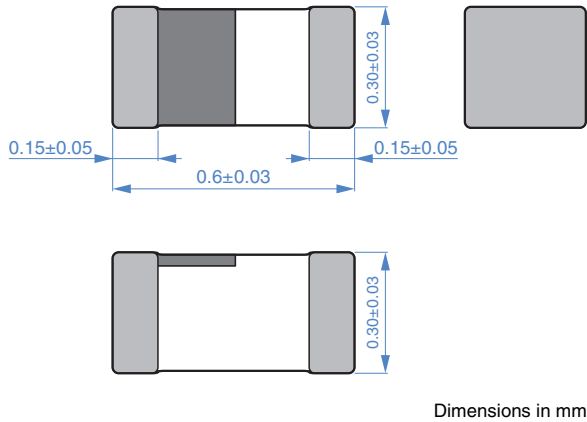

PACKAGING STYLE

REEL DIMENSIONS

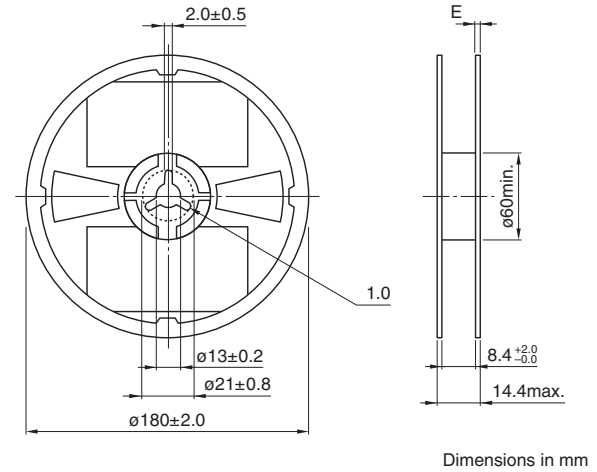

RECOMMENDED LAND PATTERN

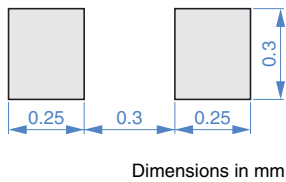

TAPE DIMENSIONS

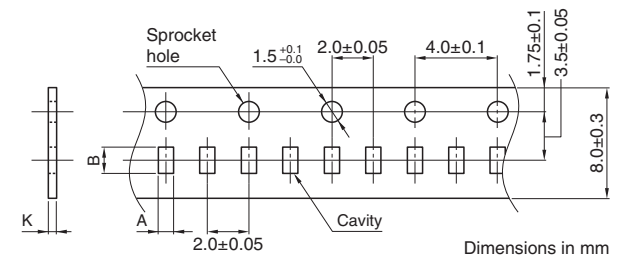

RECOMMENDED REFLOW PROFILE

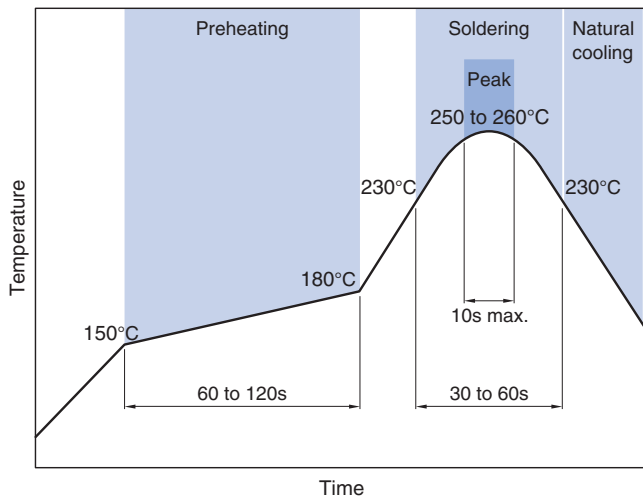

Type	A	B	K
MLG0603S	0.38±0.05	0.68±0.05	0.5 max.

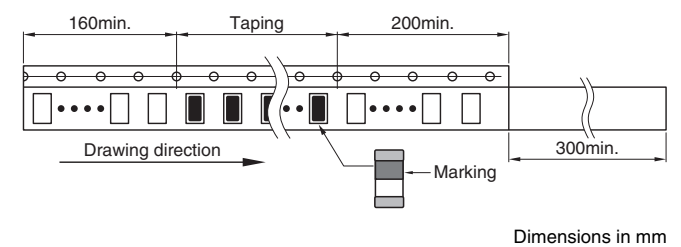

PACKAGE QUANTITY

Package quantity	15000 pcs/reel
------------------	----------------

TEMPERATURE RANGE, INDIVIDUAL WEIGHT

Operating temperature range	Storage temperature range*	Individual weight
-55 to +125 °C	-55 to +125 °C	0.2 mg

* The storage temperature range is for after the assembly.

REMINDERS FOR USING THESE PRODUCTS

Before using these products, be sure to request the delivery specifications.

SAFETY REMINDERS

Please pay sufficient attention to the warnings for safe designing when using this products.

REMINDERS

- The storage period is within 12 months. Be sure to follow the storage conditions (temperature: 5 to 40°C, humidity: 10 to 75% RH or less).
If the storage period elapses, the soldering of the terminal electrodes may deteriorate.
- Do not use or store in locations where there are conditions such as gas corrosion (salt, acid, alkali, etc.).
- Before soldering, be sure to preheat components.
The preheating temperature should be set so that the temperature difference between the solder temperature and chip temperature does not exceed 150°C.
- Soldering corrections after mounting should be within the range of the conditions determined in the specifications.
If overheated, a short circuit, performance deterioration, or lifespan shortening may occur.
- When embedding a printed circuit board where a chip is mounted to a set, be sure that residual stress is not given to the chip due to the overall distortion of the printed circuit board and partial distortion such as at screw tightening portions.
- Self heating (temperature increase) occurs when the power is turned ON, so the tolerance should be sufficient for the set thermal design.
- Carefully lay out the coil for the circuit board design of the non-magnetic shield type.
A malfunction may occur due to magnetic interference.
- Use a wrist band to discharge static electricity in your body through the grounding wire.
- Do not expose the products to magnets or magnetic fields.
- Do not use for a purpose outside of the contents regulated in the delivery specifications.
- The products listed on this catalog are intended for use in general electronic equipment (AV equipment, telecommunications equipment, home appliances, amusement equipment, computer equipment, personal equipment, office equipment, measurement equipment, industrial robots) under a normal operation and use condition.
The products are not designed or warranted to meet the requirements of the applications listed below, whose performance and/or quality require a more stringent level of safety or reliability, or whose failure, malfunction or trouble could cause serious damage to society, person or property.
If you intend to use the products in the applications listed below or if you have special requirements exceeding the range or conditions set forth in the each catalog, please contact us.

- (1) Aerospace/aviation equipment
- (2) Transportation equipment (electric trains, ships, etc.)
- (3) Medical equipment
- (4) Power-generation control equipment
- (5) Atomic energy-related equipment
- (6) Seabed equipment
- (7) Transportation control equipment

- (8) Public information-processing equipment
- (9) Military equipment
- (10) Electric heating apparatus, burning equipment
- (11) Disaster prevention/crime prevention equipment
- (12) Safety equipment
- (13) Other applications that are not considered general-purpose applications

When designing your equipment even for general-purpose applications, you are kindly requested to take into consideration securing protection circuit/device or providing backup circuits in your equipment.